

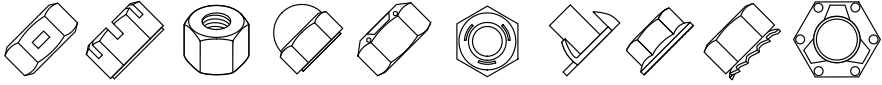

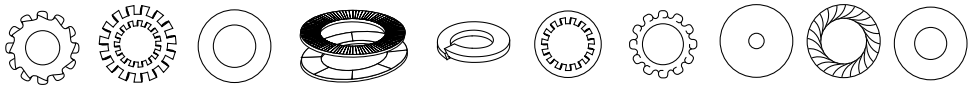



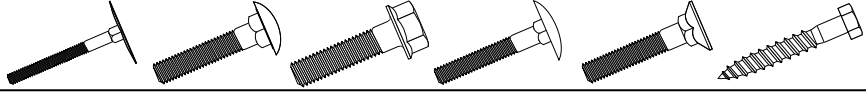
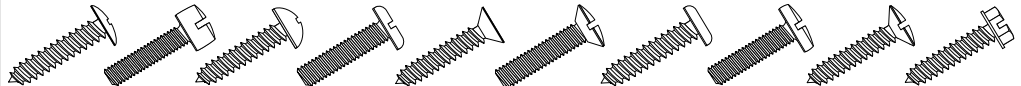
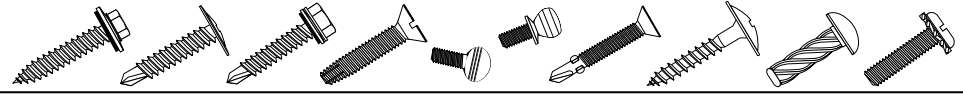
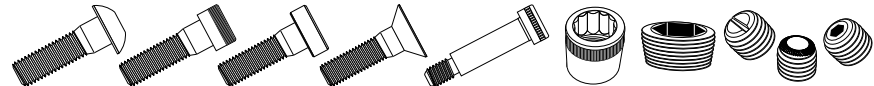
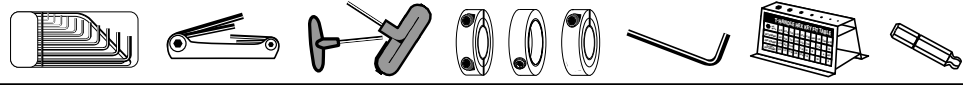
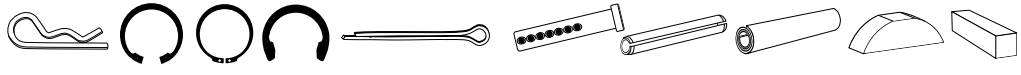

# FASTENER CATALOG

## MASTER TABLE OF CONTENTS

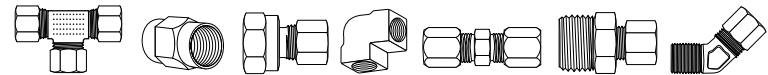
### PRODUCT GROUPS - PAGE 1

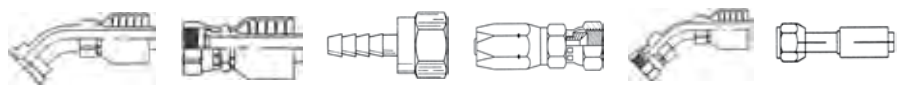
SECTION #

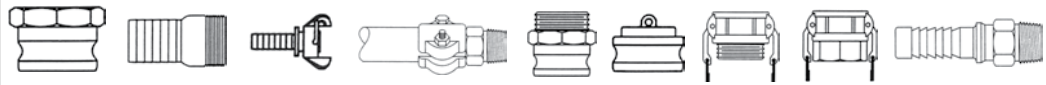
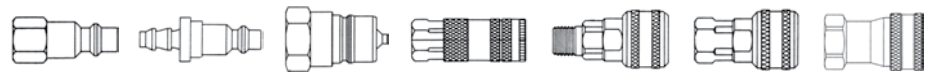
<b>1</b>	<b>NUTS</b>	STEEL 
<b>2</b>	<b>WASHERS</b>	STEEL 
<b>3</b>	<b>HEX CAP SCREWS</b>	STEEL 
<b>4</b>	<b>BOLTS</b>	
<b>5</b>	<b>MACHINE &amp; TAPPING SCREWS</b>	
<b>5</b>	<b>SPECIALTY SCREWS</b>	
<b>6</b>	<b>SOCKET SCREW PRODUCTS</b>	
<b>6</b>	<b>SHAFT COLLARS &amp; HEX KEYS</b>	
<b>7</b>	<b>PINS - KEYS - RINGS</b>	
<b>8</b>	<b>THREADED ROD STUDS</b>	GRADES 2, 5, B7, 8 NON - FERROUS 
<b>9</b>	<b>BRASS FITTINGS</b>	TUBE, PIPE, COCKS 
<b>10</b>	<b>TUBING</b>	
<b>10</b>	<b>HOSE &amp; HOSE CLAMPS</b>	FUEL - AIR WATER HYDRAULICS 
<b>10</b>	<b>HOSE FITTINGS</b>	CRIMP REUSABLE BARB 
<b>10</b>	<b>STEEL ADAPTERS</b>	
<b>10</b>	<b>AIR/WATER CAM &amp; GROOVE HOSE FITTINGS</b>	
<b>10</b>	<b>QUICK COUPLERS</b>	PNEUMATIC HYDRAULIC 



PLEASE NOTE: PICTORIAL MASTER INDEX DOES NOT SHOW ALL PRODUCTS AVAILABLE. PLEASE SEE EACH SECTION INDEX FOR FULL LINE LISTINGS.

# FASTENER CATALOG

## MASTER TABLE OF CONTENTS

### PRODUCT GROUPS - PAGE 2

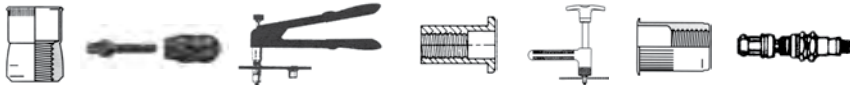
SECTION #

<b>11</b>	<b>PIPE FITTINGS</b>	BLACK GALVANIZED 304 STAINLESS 
<b>11</b>	<b>VALVES &amp; HOSE BIBBS</b>	 <b>SCHEDULE 40 &amp; 80 PVC FITTINGS IN STOCK UP TO 4"</b>
<b>12</b>	<b>RIVETING PRODUCTS</b>	
<b>12</b>	<b>THREADED INSERTS</b>	
<b>13</b>	<b>NON FERROUS</b>	
<b>14</b>	<b>LUBRICATION FITTINGS</b>	
<b>14</b>	<b>ELECTRICAL PRODUCTS</b>	
<b>15</b>	<b>ANCHORING PRODUCTS</b>	
<b>15</b>	<b>HARDWARE PRODUCTS</b>	
<b>16</b>	<b>CUTTING TOOLS</b>	
<b>16</b>	<b>DRIVING BITS &amp; TOOLS</b>	
<b>17</b>	<b>CABLE TIES</b>	
<b>17</b>	<b>LOOM CLIPS TUBING CLIPS</b>	
<b>17</b>	<b>O-RINGS ABRASIVES</b>	 <b>RUBBER TARP STRAPS</b> 
<b>17</b>	<b>THREAD REPAIR COILS - INSERTS</b>	 <b>TAPES &amp; CLAMPS</b> 
<b>17</b>	<b>WHEEL &amp; AXLE PARTS</b>	 <b>TIRE RIM WHEEL WEIGHTS</b> 
<b>17</b>	<b>POP-ON SCREW COVERS &amp; BASES</b>	 <b>HOLD DOWN BOLTS AND BATTERY BOLTS &amp; NUTS</b> 



PLEASE NOTE: PICTORIAL MASTER INDEX DOES NOT SHOW ALL PRODUCTS AVAILABLE. PLEASE SEE EACH SECTION INDEX FOR FULL LINE LISTINGS.

# FASTENER CATALOG

## MASTER TABLE OF CONTENTS

### PRODUCT GROUPS - PAGE 3

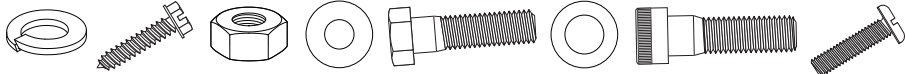
SECTION #

17	CHEMICALS, PAINTS & SEALANTS	
18	METRIC FASTENERS	
19	ASSORTMENTS	 <p style="text-align: right;"><b>STANDARD &amp; CUSTOM ASSORTMENTS</b></p>
19	STORAGE EQUIPMENT	 <p style="text-align: center;"><small>24" WIDE X 12-1/4" DEEP</small></p>

*PLEASE NOTE: PICTORIAL MASTER INDEX DOES NOT SHOW ALL PRODUCTS AVAILABLE. PLEASE SEE EACH SECTION INDEX FOR FULL LINE LISTINGS.*

**CALL: (800) 723-2826**

# SECTION 1 PRODUCT INDEX

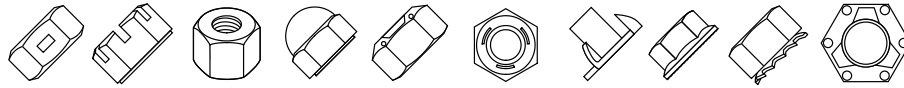

Line Description	Alpha	Line#	Page#
HEX MACHINE SCREW NUT - ZINC PLATED - UNC	CCU	3-00	1-4
HEX MACHINE SCREW NUT - ZINC PLATED - UNF	CCS	4-00	1-4
FINISHED HEX NUT - GRD 2 - ZINC PLATED - UNC	AAU	7-00	1-4
FINISHED HEX NUT - GRD 2 - ZINC PLATED - UNF	AAS	8-00	1-4
FINISHED HEX NUT - GRD 2 - PLAIN FINISH - UNC	BBU	9-00	1-5
FINISHED HEX NUT - GRD 2 - PLAIN FINISH - UNF	BBS	10-00	1-5
FINISHED HEX JAM NUT - GRD 2 - ZINC PLATED - UNC	GGU	11-00	1-5
FINISHED HEX JAM NUT - GRD 2 - ZINC PLATED - UNF	GGS	12-00	1-5
FINISHED HEX JAM NUT - GRD 8 - ZINC PLATED - UNC	AYF	12-03	1-6
FINISHED HEX JAM NUT - GRD 8 - ZINC PLATED - UNF	AYG	12-04	1-6
FINISHED HEX JAM NUT - GRD 2 - PLAIN FINISH - UNC	FFU	13-00	1-6
FINISHED HEX JAM NUT - GRD 2 - PLAIN FINISH - UNF	FFS	14-00	1-6
FINISHED HEX NUT (USA) - GRD 5 - ZINC PLATED - UNC	BDJ	14-10	1-7
FINISHED HEX NUT (USA) - GRD 5 - ZINC PLATED - UNF	BDK	14-11	1-7
FINISHED HEX NUT (GLOBAL) - GRD 5 - ZINC PLATED - UNC	APW	14-12	1-7
FINISHED HEX NUT (GLOBAL) - GRD 5 - ZINC PLATED - UNF	APX	14-13	1-7
HEAVY HEX NUT - GRD 2 - PLAIN FINISH - UNC	ATU	15-00	1-7
HEAVY HEX NUT - GRD 2 - ZINC PLATED - UNC	AUU	16-00	1-8
HEAVY HEX JAM NUT - GRD 2 - PLAIN FINISH - UNC	ADA	17-00	1-8
HIGH HEX NUT - GRD 5 - PLAIN FINISH - UNF	AKA	18-00	1-8
HIGH HEX NUT - GRD 5 - ZINC PLATED - UNF	EAD	19-00	1-9
FINISHED HEX NUT (USA) - GRD 8 - YELLOW/ZINC - UNC	BDR	19-50	1-9
FINISHED HEX NUT (USA) - GRD 8 - YELLOW/ZINC - UNF	BDT	19-51	1-9
THICK HEX NUT 180K PSI (USA) - YELLOW/ZINC - UNC	BDN	19-54	1-9
FINISHED HEX NUT - GRD 8 - PLAIN FINISH - UNC	EEU	20-00	1-9
FINISHED HEX NUT - GRD 8 - PLAIN FINISH - UNF	EES	21-00	1-9
FINISHED HEX NUT - GRD 8 - YELLOW/ZINC - UNC	DND	22-00	1-10
FINISHED HEX NUT - GRD 8 - YELLOW/ZINC - UNF	DPD	23-00	1-10
T9 ALLOY THICK HEX NUT - YELLOW/CADMIUM - UNC	ACF	23-01	1-10
T9 ALLOY THICK HEX NUT - YELLOW/CADMIUM - UNF	ACG	23-02	1-10
T9 ALLOY STOVER LOCK NUT - YELLOW/CADMIUM - UNC	ACH	23-03	1-10
T9 ALLOY STOVER LOCK NUT - YELLOW/CADMIUM - UNF	ACJ	23-04	1-11
FLANGE LOCK NUT - GRD G (8) - YELLOW/ZINC - UNC	JFS	23-05	1-11
FLANGE LOCK NUT - GRD G (8) - YELLOW/ZINC - UNF	JGS	23-06	1-11
FLANGE LOCK NUT - GRD G (USA) - PHOSPHATE/OIL - UNC	BDP	23-07	1-11
HIGH HEX NUT - GRD 8 - PLAIN FINISH - UNF	EBD	24-00	1-11
HIGH HEX NUT - GRD 8 - ZINC PLATED - UNF	ECD	25-00	1-11
A563C HEAVY HEX NUT (A325) - PLAIN FINISH - UNC	UHU	26-00	1-11
A563C HEAVY HEX NUT (A325) - ZINC PLATED - UNC	HKD	27-00	1-12
GRD DH HEAVY HEX NUT - GRD 8 - PLAIN FINISH & HOT DIP GALV - UNC	CGR	27-01	1-12

(CONTINUED...)

# SECTION 1 PRODUCT INDEX

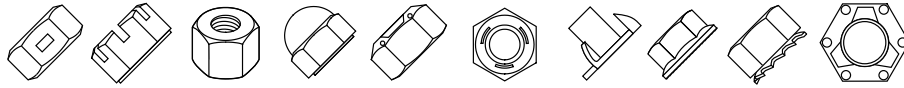

Line Description	Alpha	Line#	Page#
GRD 2H HEAVY HEX NUT (C24/C38 HRC) - UNC	HHU	28-00	1- 12
GRD 2H HEAVY HEX NUT (C24/C38 HRC) - UN8	HHH	29-00	1- 12
GRD 2H HEAVY HEX WHEEL NUT - ZINC PLATED - UNC	WWW	30-00	1- 12
HEX MACHINE SCREW NYLON INSERT LOCK NUT - ZINC - NTM - UNC	AWU	31-00	1- 12
HEX MACHINE SCREW NYLON INSERT LOCK NUT - ZINC - NTM - UNF	AWS	32-00	1- 12
GRD 2H HEAVY HEX NUT (C24/C38 HRC) ZINC PLATED - UNC	HHD	33-00	1- 13
GRD 2H HEAVY HEX NUT (C24/C38 HRC) ZINC PLATED - UN8	HJD	34-00	1- 13
NYLON INSERT LOCK NUT - ZINC PLATED - NE - UNC	AVU	35-00	1- 13
NYLON INSERT LOCK NUT - ZINC PLATED - NE - UNF	AVS	36-00	1- 13
NYLON INSERT HEX JAM LOCK NUT - ZINC PLATED - NTE - UNC	AXU	37-00	1- 13
NYLON INSERT HEX JAM LOCK NUT - ZINC PLATED - NTE - UNF	AXS	38-00	1- 14
NYLON INSERT HEAVY HEX LOCK NUT - ZINC PLATED - NU - UNC	AGA	39-00	1- 14
NYLON INSERT HEAVY HEX JAM LOCK NUT ZINC - NTU - UNC	AHA	40-00	1- 14
NYLON INSERT HIGH HEX LOCK NUT - ZINC PLATED - UNF	AJA	41-00	1- 14
NYLON INSERT HEX LOCK NUT - GR. 8 - YEL/ZINC - NE - UNC/UNF	JXF	41-01	1- 14
GRADE C STEEL LOCK NUT - YELLOW/ZINC/WAX - UNC	BRU	42-00	1- 15
GRADE C STEEL LOCK NUT - YELLOW/ZINC/WAX - UNF	BRS	43-00	1- 15
GRADE C STEEL LOCK NUT (USA) - YELLOW/CAD/WAX - UNC	BDW	43-01	1- 15
GRADE C STEEL LOCK NUT (USA) - YELLOW/CAD/WAX - UNF	BDX	43-02	1- 15
GRADE B STEEL LOCK NUT - ZINC/WAX - UNC	BSU	44-00	1- 16
GRADE B STEEL LOCK NUT - ZINC/WAX - UNF	BSS	45-00	1- 16
LIGHT HEX FLEXLOC NUT - CADMIUM PLATED - UNC	BTU	46-00	1- 16
LIGHT HEX FLEXLOC NUT - PLAIN FINISH - UNC	JJK	46-01	1- 16
LIGHT HEX FLEXLOC NUT - CADMIUM PLATED - UNF	BTS	47-00	1- 16
LIGHT HEX FLEXLOC NUT - PLAIN FINISH - UNF	JKK	47-01	1- 17
LIGHT HEX JAM FLEXLOC NUT - CADMIUM PLATED - UNC	BUU	48-00	1- 17
LIGHT HEX JAM FLEXLOC NUT - PLAIN FINISH - UNC	JLK	48-01	1- 17
LIGHT HEX JAM FLEXLOC NUT - CADMIUM PLATED - UNF	BUS	49-00	1- 17
LIGHT HEX JAM FLEXLOC NUT - PLAIN FINISH - UNF	JMK	49-01	1- 18
HEAVY HEX FLEXLOC NUT - PLAIN FINISH - UNC	APA	50-00	1- 18
HEAVY HEX FLEXLOC NUT - CADMIUM PLATED - UNC	JNK	50-01	1- 18
HEAVY HEX JAM FLEXLOC NUT - PLAIN FINISH - UNC	AUA	51-00	1- 18
HEAVY HEX JAM FLEXLOC NUT - CADMIUM PLATED - UNC	JPK	51-01	1- 18
FINISHED 2/WAY LOCK NUT - GRADE 2 - ZINC PLATED - UNC	BXU	52-00	1- 19
FINISHED 2/WAY LOCK NUT - GRADE 2 - ZINC PLATED - UNF	BXS	53-00	1- 19
HEX K-LOCK NUT (KEPS STYLE) - ZINC PLATED - UNC	BCU	54-00	1- 19
HEX K-LOCK NUT (KEPS STYLE) - ZINC PLATED - UNF	BCS	55-00	1- 19
FINISHED HEX CASTLE NUT - ZINC PLATED - UNF	KKS	59-00	1- 19
FINISHED HEX CASTLE NUT - PLAIN STEEL - UNC	LLU	60-00	1- 19
FINISHED HEX CASTLE NUT - PLAIN FINISH - UNF	LLS	61-00	1- 20

(CONTINUED...)

# SECTION 1 PRODUCT INDEX

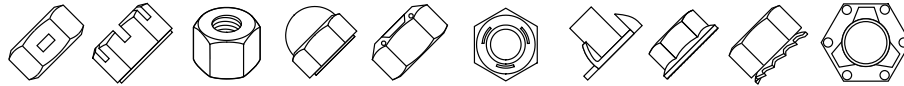

Line Description	Alpha	Line#	Page#
FINISHED HEX SLOTTED NUT - PLAIN FINISH - UNC	<b>NNU</b>	<b>62-00</b>	<b>1- 20</b>
FINISHED HEX SLOTTED NUT - PLAIN FINISH - UNF	<b>NNS</b>	<b>63-00</b>	<b>1- 20</b>
HEAVY HEX SLOTTED NUT - PLAIN FINISH - UNC	<b>AEA</b>	<b>66-00</b>	<b>1- 20</b>
FINISHED HEX SLOTTED NUT - ZINC PLATED - UNF	<b>DYD</b>	<b>68-00</b>	<b>1- 21</b>
STAMPED WING NUT - ZINC PLATED - UNC	<b>AYU</b>	<b>71-00</b>	<b>1- 21</b>
FORGED WING NUT - ZINC PLATED - UNC	<b>AZU</b>	<b>72-00</b>	<b>1- 21</b>
FORGED WING NUT - ZINC PLATED - UNF	<b>AZS</b>	<b>73-00</b>	<b>1- 21</b>
HEX CAP NUT - 2 PIECE - NICKEL PLATED - UNC	<b>BDU</b>	<b>78-00</b>	<b>1- 21</b>
HEX CAP NUT - 2 PIECE - NICKEL PLATED - UNF	<b>BDS</b>	<b>79-00</b>	<b>1- 21</b>
HEX MILLED CAP NUT (LOW DOME) - ZINC PLATED - UNC	<b>BEU</b>	<b>80-00</b>	<b>1- 21</b>
HEX MILLED CAP NUT (LOW DOME) - ZINC PLATED - UNF	<b>BES</b>	<b>81-00</b>	<b>1- 22</b>
HEX ROD COUPLING NUT - ZINC PLATED - UNC	<b>ALA</b>	<b>84-00</b>	<b>1- 22</b>
FINISHED HEX NUT - HOT-DIPPED GALVANIZED - UNC	<b>AWA</b>	<b>85-00</b>	<b>1- 22</b>
HEAVY HEX NUT - HOT-DIPPED GALVANIZED - UNC	<b>AXA</b>	<b>86-00</b>	<b>1- 22</b>
HEAVY HEX NUT - GRADE 2H - HOT-DIPPED GALV - UNC/UN8	<b>BDY</b>	<b>86-01</b>	<b>1- 22</b>
SQUARE MACHINE SCREW NUT - ZINC PLATED - UNC/UNF	<b>ARA</b>	<b>87-00</b>	<b>1- 23</b>
REGULAR SQUARE NUT - PLAIN FINISH - UNC	<b>ATA</b>	<b>89-00</b>	<b>1- 23</b>
REGULAR SQUARE NUT - ZINC PLATED - UNC	<b>DMD</b>	<b>91-00</b>	<b>1- 23</b>
PRONGED TEE NUT - ZINC PLATED - UNC/UNF	<b>AQA</b>	<b>92-00</b>	<b>1- 23</b>
SERRATED FLANGE HEX NUT - ZINC - CASE HARD - UNC/UNF	<b>ZLB</b>	<b>95-00</b>	<b>1- 23</b>
LEFT HAND FINISHED HEX NUT - PLAIN FINISH - UNC	<b>BNU</b>	<b>96-00</b>	<b>1- 24</b>
LEFT HAND FINISHED HEX NUT - PLAIN FINISH - UNF	<b>BNS</b>	<b>97-00</b>	<b>1- 24</b>
LEFT HAND FINISHED HEX JAM NUT - PLAIN FINISH - UNC	<b>BPU</b>	<b>98-00</b>	<b>1- 24</b>
LEFT HAND FINISHED HEX JAM NUT - PLAIN FINISH - UNF	<b>BPS</b>	<b>99-00</b>	<b>1- 24</b>
LEFT HAND HEAVY HEX NUT - PLAIN FINISH - UNC	<b>AMA</b>	<b>100-00</b>	<b>1- 24</b>



**CALL - 1 (800) 723-2826**

**HEX MACHINE SCREW NUT**

ZINC PLATED, UNC

Line: 003-00

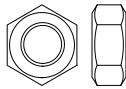

PART NUMBER	SIZE	QTY/BX	LIST PRICE
CCU00	#0-80	100	
CCU11	#1-64	100	
CCU22	#2-56	100	
CCU33	#3-48	100	
CCU432	#4-32	100	
CCU436	#4-36	100	
CCU44	#4-40	100	
CCU55	#5-40	100	
CCU66	#6-32	100	
CCU88	#8-32	100	
CCU88SX	#8-32 (1/4 AF)	100	
CCU03	#10-24	100	
CCU21	#12-24	100	
CCU1420	#14-20	100	
CCU04	1/4-20	100	
CCU05	5/16-18	100	
CCU06	3/8-16	100	

**HEX MACHINE SCREW NUT**

ZINC PLATED, UNF

Line: 004-00

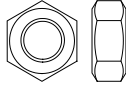

PART NUMBER	SIZE	QTY/BX	LIST PRICE
CCS11	#1-72	100	
CCS22	#2-64	100	
CCS33	#3-56	100	
CCS44	#4-48	100	
CCS55	#5-44	100	
CCS66	#6-40	100	
CCS88	#8-36 (11/32 X 1/8)	100	
CCS03	#10-32	100	
CCS03X	#10-32 (5/16 AF)	100	
CCS21	#12-28	100	
CCS04	1/4-28	100	
CCS05	5/16-24	100	
CCS06	3/8-24	100	

**GRADE 2 FINISHED HEX NUT**

ZINC PLATED, UNC

Line: 007-00



PART NUMBER	SIZE	QTY/BX	LIST PRICE
AAU04	1/4-20	100	
AAU05	5/16-18	100	
AAU06	3/8-16	100	
AAU07	7/16-14 (5/8 AF)	100	
AAU07RX	7/16-14 (11/16 AF)	100	
AAU08	1/2-13	100	

(continued...)

**GRADE 2 FINISHED HEX NUT (cont.)**

ZINC PLATED, UNC

Line: 007-00

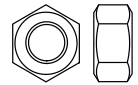

PART NUMBER	SIZE	QTY/BX	LIST PRICE
AAU09	9/16-12	50	
AAU10	5/8-11	50	
AAU12	3/4-10	50	
AAU14	7/8-9	25	
AAU16	1-8	25	
AAU18	1 1/8-7	25	
AAU20	1 1/4-7	25	
AAU22	1 3/8-6	10	
AAU24	1 1/2-6	10	
AAU26	1 5/8-5 1/2	5	
AAU28	1 3/4-5	5	
AAU32	2-4 1/2	5	
AAU36	2 1/4-4 1/2	1	
AAU40	2 1/2-4	1	
AAU44	2 3/4-4	1	
AAU48	3-4	1	

**GRADE 2 FINISHED HEX NUT**

ZINC PLATED, UNF

Line: 008-00

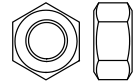

PART NUMBER	SIZE	QTY/BX	LIST PRICE
AAS04	1/4-28	100	
AAS05	5/16-24	100	
AAS06	3/8-24	100	
AAS07	7/16-20 (5/8 AF)	100	
AAS07RX	7/16-20 (11/16 AF)	100	
AAS08	1/2-20	100	
AAS09	9/16-18	50	
AAS10	5/8-18	50	
AAS12	3/4-16	50	
AAS14	7/8-14	25	
AAS16	1-14	25	
AAS16X	1-12	25	
AAS18	1 1/8-12	25	
AAS20	1 1/4-12	25	
AAS22	1 3/8-12	10	
AAS24	1 1/2-12	10	
AAS26	1 5/8-12	5	
AAS28	1 3/4-12	5	
AAS30	1 7/8-12	5	
AAS32	2-12	5	
AAS36	2 1/4-12	1	
AAS40	2 1/2-12	1	
AAS44	2 3/4-12	1	
AAS48	3-12	1	

**GRADE 2 FINISHED HEX NUT**

PLAIN STEEL, UNC

Line: 009-00

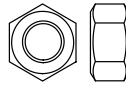

PART NUMBER	SIZE	QTY/BX	LIST PRICE
BBU04	1/4-20	100	
BBU05	5/16-18	100	
BBU06	3/8-16	100	
BBU07	7/16-14 (5/8 AF)	100	
BBU07RX	7/16-14 (11/16 AF)	100	
BBU08	1/2-13	100	
BBU09	9/16-12	50	
BBU10	5/8-11	50	
BBU12	3/4-10	50	
BBU14	7/8-9	25	
BBU16	1-8	25	
BBU18	1 1/8-7	25	
BBU20	1 1/4-7	25	
BBU22	1 3/8-6	10	
BBU24	1 1/2-6	10	
BBU26	1 5/8-5 1/2	5	
BBU28	1 3/4-5	5	
BBU30	1 7/8-5	5	
BBU32	2-4 1/2	5	
BBU36	2 1/4-4 1/2	1	
BBU40	2 1/2-4	1	
BBU44	2 3/4-4	1	
BBU48	3-4	1	

**GRADE 2 FINISHED HEX NUT**

PLAIN STEEL, UNF

Line: 010-00

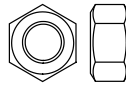

PART NUMBER	SIZE	QTY/BX	LIST PRICE
BBS04	1/4-28	100	
BBS05	5/16-24	100	
BBS06	3/8-24	100	
BBS07	7/16-20 (5/8 AF)	100	
BBS07RX	7/16-20 (11/16 AF)	100	
BBS08	1/2-20	100	
BBS09	9/16-18	50	
BBS10	5/8-18	50	
BBS12	3/4-16	50	
BBS14	7/8-14	25	
BBS16	1-14	25	
BBS16X	1-12	25	
BBS18	1 1/8-12	25	
BBS20	1 1/4-12	25	
BBS22	1 3/8-12	10	
BBS24	1 1/2-12	10	
BBS26	1 5/8-12	5	

(continued...)

**GRADE 2 FINISHED HEX NUT (cont.)**

PLAIN STEEL, UNF

Line: 010-00

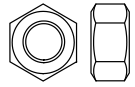

PART NUMBER	SIZE	QTY/BX	LIST PRICE
BBS28	1 3/4-12	5	
BBS30	1 7/8-12	5	
BBS32	2-12	5	
BBS36	2 1/4-12	1	
BBS40	2 1/2-12	1	
BBS44	2 3/4-12	1	
BBS48	3-12	1	

**GRADE 2 FINISHED HEX JAM NUT**

ZINC PLATED, UNC

Line: 011-00

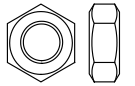

PART NUMBER	SIZE	QTY/BX	LIST PRICE
GGU04	1/4-20	100	
GGU05	5/16-18	100	
GGU06	3/8-16	100	
GGU07	7/16-14	100	
GGU08	1/2-13	100	
GGU09	9/16-12	50	
GGU10	5/8-11	50	
GGU12	3/4-10	50	
GGU14	7/8-9	25	
GGU16	1-8	25	
GGU18	1 1/8-7	25	
GGU20	1 1/4-7	25	
GGU22	1 3/8-6	10	
GGU24	1 1/2-6	10	
GGU28	1 3/4-5	5	
GGU32	2-4 1/2	5	
GGU36	2 1/4-4 1/2	1	
GGU40	2 1/2-4	1	
GGU44	2 3/4-4	1	
GGU48	3-4	1	

**GRADE 2 FINISHED HEX JAM NUT**

ZINC PLATED, UNF

Line: 012-00

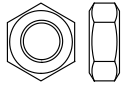

PART NUMBER	SIZE	QTY/BX	LIST PRICE
GGS04	1/4-28	100	
GGS05	5/16-24	100	
GGS06	3/8-24	100	
GGS07	7/16-20	100	
GGS08	1/2-20	100	
GGS09	9/16-18	50	
GGS10	5/8-18	50	
GGS12	3/4-16	50	
GGS14	7/8-14	25	

(continued...)



**GRADE 2 FINISHED HEX JAM NUT (cont.)**

ZINC PLATED, UNF  
Line: 012-00

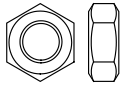

PART NUMBER	SIZE	QTY/BX	LIST PRICE
GGS16	1-14	25	
GGS18	1 1/8-12	25	
GGS20	1 1/4-12	25	
GGS22	1 3/8-12	10	
GGS24	1 1/2-12	10	
GGS28	1 3/4-12	5	
GGS30	1 7/8-12	5	
GGS32	2-12	5	
GGS36	2 1/4-12	1	

**GRADE 8 - FINISHED HEX JAM NUT**

ZINC PLATED, UNC  
Line: 012-03

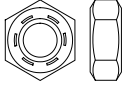

PART NUMBER	SIZE	QTY/BX	LIST PRICE
AYF04	1/4-20	100	
AYF05	5/16-18	100	
AYF06	3/8-16	100	
AYF07	7/16-14	100	
AYF08	1/2-13	100	
AYF09	9/16-12	50	
AYF10	5/8-11	50	
AYF12	3/4-10	50	
AYF14	7/8-9	25	
AYF16	1-8	25	
AYF18	1 1/8-7	25	
AYF20	1 1/4-7	25	
AYF22	1 3/8-6	10	
AYF24	1 1/2-6	10	
AYF28	1 3/4-5 (Plain)	5	
AYF32	2-4 1/2 (Plain)	5	

**GRADE 8 - FINISHED HEX JAM NUT**

ZINC PLATED, UNF  
Line: 012-04

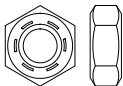

PART NUMBER	SIZE	QTY/BX	LIST PRICE
AYG04	1/4-28	100	
AYG05	5/16-24	100	
AYG06	3/8-24	100	
AYG07	7/16-20	100	
AYG08	1/2-20	100	
AYG09	9/16-18	50	
AYG10	5/8-18	50	
AYG12	3/4-16	50	
AYG14	7/8-14	25	
AYG16	1-14	25	
AYG18	1 1/8-12	25	

(continued...)

**GRADE 8 - FINISHED HEX JAM NUT (cont.)**

ZINC PLATED, UNF  
Line: 012-04

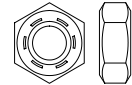

PART NUMBER	SIZE	QTY/BX	LIST PRICE
AYG20	1 1/4-12	25	
AYG22	1 3/8-12	10	
AYG24	1 1/2-12	10	
AYG28	1 3/4-12 (Plain)	5	
AYG32	2-12 (Plain)	5	

**GRADE 2 FINISHED HEX JAM NUT**

PLAIN STEEL, UNC  
Line: 013-00

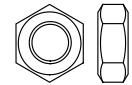

PART NUMBER	SIZE	QTY/BX	LIST PRICE
FFU04	1/4-20	100	
FFU05	5/16-18	100	
FFU06	3/8-16	100	
FFU07	7/16-14	100	
FFU08	1/2-13	100	
FFU09	9/16-12	50	
FFU10	5/8-11	50	
FFU12	3/4-10	50	
FFU14	7/8-9	25	
FFU16	1-8	25	
FFU18	1 1/8-7	25	
FFU20	1 1/4-7	25	
FFU22	1 3/8-6	10	
FFU24	1 1/2-6	10	
FFU28	1 3/4-5	5	
FFU32	2-4 1/2	5	
FFU36	2 1/4-4 1/2	1	
FFU40	2 1/2-4	1	
FFU44	2 3/4-4	1	
FFU48	3-4	1	

**GRADE 2 FINISHED HEX JAM NUT**

PLAIN STEEL, UNF  
Line: 014-00



PART NUMBER	SIZE	QTY/BX	LIST PRICE
FFS04	1/4-28	100	
FFS05	5/16-24	100	
FFS06	3/8-24	100	
FFS07	7/16-20	100	
FFS08	1/2-20	100	
FFS09	9/16-18	50	
FFS10	5/8-18	50	
FFS12	3/4-16	50	
FFS14	7/8-14	25	
FFS16	1-14	25	

(continued...)

## GRADE 2 FINISHED HEX JAM NUT (cont.)

PLAIN STEEL, UNF

Line: 014-00

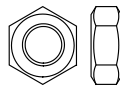

PART NUMBER	SIZE	QTY/BX	LIST PRICE
FFS18	1 1/8-12	25	
FFS20	1 1/4-12	25	
FFS22	1 3/8-12	10	
FFS24	1 1/2-12	10	
FFS26	1 5/8-12	1	
FFS28	1 3/4-12	5	
FFS30	1 7/8-12	5	
FFS32	2-12	5	
FFS36	2 1/4-12	1	
FFS40	2 1/2-12	1	
FFS48	3-12	1	

## GRADE 5 - FINISHED HEX NUT

ZINC PLATED, UNC - MADE IN THE U.S.A.

Line: 014-10

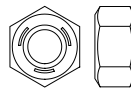

PART NUMBER	SIZE	QTY/BX	LIST PRICE
BDJ04	1/4-20	100	
BDJ05	5/16-18	100	
BDJ06	3/8-16	100	
BDJ07	7/16-14	100	
BDJ08	1/2-13	100	
BDJ09	9/16-12	50	
BDJ10	5/8-11	50	
BDJ12	3/4-10	50	
BDJ14	7/8-9	25	
BDJ16	1-8	25	

## GRADE 5 - FINISHED HEX NUT

ZINC PLATED, UNF - MADE IN THE U.S.A.

Line: 014-11

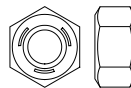

PART NUMBER	SIZE	QTY/BX	LIST PRICE
BDK04	1/4-28	100	
BDK05	5/16-24	100	
BDK06	3/8-24	100	
BDK07	7/16-20	100	
BDK08	1/2-20	100	
BDK09	9/16-18	50	
BDK10	5/8-18	50	
BDK12	3/4-16	50	
BDK14	7/8-14	25	
BDK16	1-14	25	

## GRADE 5 - FINISHED HEX NUT

ZINC PLATED, UNC

Line: 014-12

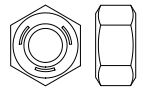

PART NUMBER	SIZE	QTY/BX	LIST PRICE
APW04	1/4-20	100	
APW05	5/16-18	100	
APW06	3/8-16	100	
APW07	7/16-14	100	
APW08	1/2-13	100	
APW09	9/16-12	50	
APW10	5/8-11	50	
APW12	3/4-10	50	
APW14	7/8-9	25	
APW16	1-8	25	
APW18	1 1/8-7	10	
APW20	1 1/4-7	10	
APW24	1 1/2-6	10	

## GRADE 5 - FINISHED HEX NUT

ZINC PLATED, UNF

Line: 014-13

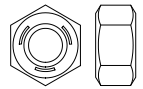

PART NUMBER	SIZE	QTY/BX	LIST PRICE
APX04	1/4-28	100	
APX05	5/16-24	100	
APX06	3/8-24	100	
APX07	7/16-20	100	
APX08	1/2-20	100	
APX09	9/16-18	50	
APX10	5/8-18	50	
APX12	3/4-16	50	
APX14	7/8-14	25	
APX16	1-14	25	
APX20	1 1/4-12	10	
APX24	1 1/2-12	10	

## GRADE 2 HEAVY HEX NUT

PLAIN STEEL, UNC

Line: 015-00

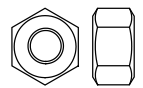

PART NUMBER	SIZE	QTY/BX	LIST PRICE
ATU04	1/4-20	100	
ATU05	5/16-18	100	
ATU06	3/8-16	100	
ATU07	7/16-14	100	
ATU08	1/2-13	100	
ATU09	9/16-12	50	
ATU10	5/8-11	50	
ATU12	3/4-10	25	
ATU14	7/8-9	25	
ATU16	1-8	25	

(continued...)

**GRADE 2 HEAVY HEX NUT (cont.)**

PLAIN STEEL, UNC  
Line: 015-00

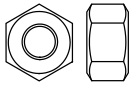

PART NUMBER	SIZE	QTY/BX	LIST PRICE
ATU18	1 1/8-7	25	
ATU20	1 1/4-7	15	
ATU22	1 3/8-6	10	
ATU24	1 1/2-6	10	
ATU26	1 5/8-5 1/2	5	
ATU28	1 3/4-5	5	
ATU32	2-4 1/2	5	
ATU36	2 1/4-4 1/2	5	
ATU40	2 1/2-4	1	
ATU44	2 3/4-4	1	
ATU48	3-4	1	
ATU52	3 1/4-4	1	
ATU56	3 1/2-4	1	
ATU64	4-4	1	

**GRADE 2 HEAVY HEX NUT**

ZINC PLATED, UNC  
Line: 016-00



PART NUMBER	SIZE	QTY/BX	LIST PRICE
AUU04	1/4-20	100	
AUU05	5/16-18	100	
AUU06	3/8-16	100	
AUU07	7/16-14	100	
AUU08	1/2-13	100	
AUU09	9/16-12	50	
AUU10	5/8-11	50	
AUU12	3/4-10	25	
AUU14	7/8-9	25	
AUU16	1-8	25	
AUU18	1 1/8-7	25	
AUU20	1 1/4-7	15	
AUU22	1 3/8-6	10	
AUU24	1 1/2-6	10	
AUU26	1 5/8-5 1/2	5	
AUU28	1 3/4-5	5	
AUU32	2-4 1/2	5	
AUU36	2 1/4-4 1/2	1	
AUU40	2 1/2-4	1	
AUU44	2 3/4-4	1	
AUU48	3-4	1	
AUU52	3 1/4-4	1	
AUU56	3 1/2-4	1	
AUU64	4-4	1	

**GRADE 2 HEAVY HEX JAM NUT**

PLAIN STEEL, UNC  
Line: 017-00

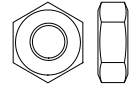

PART NUMBER	SIZE	QTY/BX	LIST PRICE
ADA04	1/4-20	100	
ADA05	5/16-18	100	
ADA06	3/8-16	100	
ADA07	7/16-14	100	
ADA08	1/2-13	100	
ADA09	9/16-12	50	
ADA10	5/8-11	50	
ADA12	3/4-10	50	
ADA14	7/8-9	25	
ADA16	1-8	25	
ADA18	1 1/8-7	25	
ADA20	1 1/4-7	15	
ADA22	1 3/8-6	15	
ADA24	1 1/2-6	10	
ADA26	1 5/8-5 1/2	5	
ADA28	1 3/4-5	5	
ADA32	2-4 1/2	5	
ADA36	2 1/4-4 1/2	1	
ADA40	2 1/2-4	1	
ADA44	2 3/4-4	1	
ADA48	3-4	1	
ADA52	3 1/4-4	1	
ADA56X	3 1/2-4	1	
ADA64	4	1	

**GRADE 5 - HIGH HEX NUT**

PLAIN STEEL, UNF  
Line: 018-00

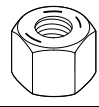

PART NUMBER	SIZE	QTY/BX	LIST PRICE
AKA06	3/8-24	100	
AKA07	7/16-20	100	
AKA08	1/2-20	100	
AKA09	9/16-18	50	
AKA10	5/8-18	50	
AKA12	3/4-16	25	
AKA14	7/8-14	25	
AKA16	1-14	25	
AKA18	1 1/8-12	15	
AKA20	1 1/4-12	15	
AKA24	1 1/2-12	10	

## GRADE 5 - HIGH HEX NUT

ZINC PLATED, UNF

Line: 019-00

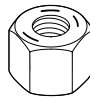

PART NUMBER	SIZE	QTY/BX	LIST PRICE
EAD06	3/8-24	100	
EAD07	7/16-20	100	
EAD08	1/2-20	50	
EAD09	9/16-18	50	
EAD10	5/8-18	50	
EAD12	3/4-16	25	
EAD14	7/8-14	25	
EAD16	1-14	25	
EAD18	1 1/8-12	15	
EAD20	1 1/4-12	15	
EAD24	1 1/2-12	10	

## GRADE 8 - FINISHED HEX NUT

ZINC/YELLOW, UNC - MADE IN THE U.S.A.

Line: 019-50

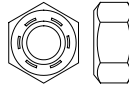

PART NUMBER	SIZE	QTY/BX	LIST PRICE
BDR04	1/4-20	100	
BDR05	5/16-18	100	
BDR06	3/8-16	100	
BDR07	7/16-14	100	
BDR08	1/2-13	100	
BDR09	9/16-12	50	
BDR10	5/8-11	50	
BDR12	3/4-10	50	
BDR14	7/8-9	25	
BDR16	1-8	25	

## GRADE 8 - FINISHED HEX NUT

ZINC/YELLOW, UNF - MADE IN THE U.S.A.

Line: 019-51

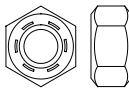

PART NUMBER	SIZE	QTY/BX	LIST PRICE
BDT04	1/4-28	100	
BDT05	5/16-24	100	
BDT06	3/8-24	100	
BDT07	7/16-20	100	
BDT08	1/2-20	100	
BDT09	9/16-18	50	
BDT10	5/8-18	50	
BDT12	3/4-16	50	
BDT14	7/8-14	25	
BDT16	1-14	25	

## GRADE 8 - THICK NUT

ZINC/YELLOW, UNC - MADE IN THE U.S.A.

Line: 019-54

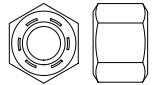

PART NUMBER	SIZE	QTY/BX	LIST PRICE
BDN04	1/4-20	100	
BDN05	5/16-18	100	
BDN06	3/8-16	100	
BDN07	7/16-14	100	
BDN08	1/2-13	100	
BDN10	5/8-11	50	
BDN12	3/4-10	25	

## GRADE 8 - FINISHED HEX NUT

PLAIN STEEL, UNC

Line: 020-00

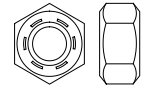

PART NUMBER	SIZE	QTY/BX	LIST PRICE
EEU04	1/4-20	100	
EEU05	5/16-18	100	
EEU06	3/8-16	100	
EEU07	7/16-14	100	
EEU08	1/2-13	100	
EEU09	9/16-12	50	
EEU10	5/8-11	50	
EEU12	3/4-10	50	
EEU14	7/8-9	25	
EEU16	1-8	25	
EEU18	1 1/8-7	25	
EEU20	1 1/4-7	10	
EEU22	1 3/8-6	10	
EEU24	1 1/2-6	10	
EEU28	1 3/4-5	5	
EEU32	2-4 1/2	1	

## GRADE 8 - FINISHED HEX NUT

PLAIN STEEL, UNF

Line: 021-00

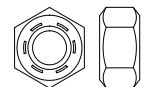

PART NUMBER	SIZE	QTY/BX	LIST PRICE
EES04	1/4-28	100	
EES05	5/16-24	100	
EES06	3/8-24	100	
EES07	7/16-20	100	
EES08	1/2-20	100	
EES09	9/16-18	50	
EES10	5/8-18	50	
EES12	3/4-16	50	
EES14	7/8-14	25	
EES16	1-14	25	
EES18	1 1/8-12	25	
EES20	1 1/4-12	10	
EES22	1 3/8-12	10	

(continued...)

**GRADE 8 - FINISHED HEX NUT (cont.)**

PLAIN STEEL, UNF

Line: 021-00

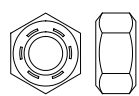

PART NUMBER	SIZE	QTY/BX	LIST PRICE
EES24	1 1/2-12	10	
EES28	1 3/4-12	1	
EES32	2-12	1	

**GRADE 8 - FINISHED HEX NUT**

ZINC/YELLOW, UNC

Line: 022-00

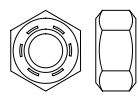

PART NUMBER	SIZE	QTY/BX	LIST PRICE
DND04	1/4-20	100	
DND05	5/16-18	100	
DND06	3/8-16	100	
DND07	7/16-14	100	
DND08	1/2-13	100	
DND09	9/16-12	50	
DND10	5/8-11	50	
DND12	3/4-10	50	
DND14	7/8-9	25	
DND16	1-8	25	
DND18	1 1/8-7	25	
DND20	1 1/4-7	10	
DND22	1 3/8-6	10	
DND24	1 1/2-6	10	
DND28	1 3/4-5	5	

**GRADE 8 - FINISHED HEX NUT**

ZINC/YELLOW, UNF

Line: 023-00

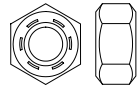

PART NUMBER	SIZE	QTY/BX	LIST PRICE
DPD04	1/4-28	100	
DPD05	5/16-24	100	
DPD06	3/8-24	100	
DPD07	7/16-20	100	
DPD08	1/2-20	100	
DPD09	9/16-18	50	
DPD10	5/8-18	50	
DPD12	3/4-16	50	
DPD14	7/8-14	25	
DPD16	1-14	25	
DPD18	1 1/8-12	25	
DPD20	1 1/4-12	10	
DPD22	1 3/8-12	10	
DPD24	1 1/2-12	10	

**T9 ALLOY - THICK HEX NUT**

YELLOW DICHROMATE, UNC

Line: 023-01

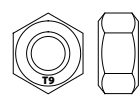

PART NUMBER	SIZE	QTY/BX	LIST PRICE
ACF04	1/4-20	100	
ACF05	5/16-18	50	
ACF06	3/8-16	50	
ACF07	7/16-14	25	
ACF08	1/2-13	25	
ACF09	9/16-12	25	
ACF10	5/8-11	25	
ACF12	3/4-10	20	
ACF14	7/8-9	15	
ACF16	1-8	10	
ACF18	1 1/8-7	10	
ACF20	1 1/4-7	10	
ACF24	1 1/2-6	6	

**T9 ALLOY - THICK HEX NUT**

YELLOW DICHROMATE, UNF

Line: 023-02

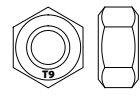

PART NUMBER	SIZE	QTY/BX	LIST PRICE
ACG04	1/4-28	100	
ACG05	5/16-24	100	
ACG06	3/8-24	100	
ACG07	7/16-20	25	
ACG08	1/2-20	25	
ACG09	9/16-18	25	
ACG10	5/8-18	25	
ACG12	3/4-16	20	
ACG14	7/8-14	15	
ACG16	1-14	10	
ACG18	1 1/8-12	10	
ACG20	1 1/4-12	10	
ACG24	1 1/2-12	6	

**T9 - STOVER LOCK NUT**

YELLOW DICHROMATE, UNC

Line: 023-03

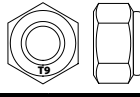

PART NUMBER	SIZE	QTY/BX	LIST PRICE
ACH04	1/4-20	100	
ACH05	5/16-18	100	
ACH06	3/8-16	50	
ACH07	7/16-14	25	
ACH08	1/2-13	25	
ACH09	9/16-12	25	
ACH10	5/8-11	25	
ACH12	3/4-10	20	
ACH14	7/8-9	15	
ACH16	1-8	10	

(continued...)

**T9 - STOVER LOCK NUT (cont.)**

YELLOW DICHROMATE, UNC

Line: 023-03

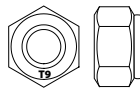

PART NUMBER	SIZE	QTY/BX	LIST PRICE
ACH18	1 1/8-7	10	
ACH20	1 1/4-7	10	
ACH24	1 1/2-6	5	

**T9 STOVER LOCK NUT**

YELLOW DICHROMATE, UNF

Line: 023-04

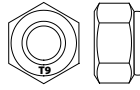

PART NUMBER	SIZE	QTY/BX	LIST PRICE
ACJ04	1/4-28	100	
ACJ05	5/16-24	100	
ACJ06	3/8-24	50	
ACJ07	7/16-20	25	
ACJ08	1/2-20	25	
ACJ09	9/16-18	25	
ACJ10	5/8-18	50	
ACJ12	3/4-16	20	
ACJ14	7/8-14	15	
ACJ16	1-14	10	
ACJ18	1 1/8-12	10	
ACJ20	1 1/4-12	10	
ACJ24	1 1/2-12	6	

**GRADE G - FLANGE LOCK NUT**

YELLOW DICHROMATE, UNC

Line: 023-05

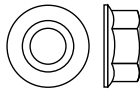

PART NUMBER	SIZE	QTY/BX	LIST PRICE
JFS04	1/4-20	100	
JFS05	5/16-18	100	
JFS06	3/8-16	100	
JFS06GF	3/8-16 (Clear Zinc)	100	
JFS07	7/16-14	100	
JFS08	1/2-13	50	
JFS10	5/8-11	50	
JFS12	3/4-10	25	
JFS14	7/8-9	25	
JFS16	1-8	25	

**GRADE G - FLANGE LOCK NUT**

YELLOW DICHROMATE, UNF

Line: 023-06



PART NUMBER	SIZE	QTY/BX	LIST PRICE
JGS07	7/16-20	100	
JGS08	1/2-20	50	
JGS10	5/8-18	50	
JGS12	3/4-16	25	
JGS14	7/8-14	25	
JGS16	1-14	25	

**GRADE G FLANGE LOCK NUT**

BLACK PHOSPHATE/OIL, UNC - MADE IN THE U.S.A.

Line: 023-07

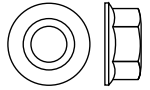

PART NUMBER	SIZE	QTY/BX	LIST PRICE
BDP06	3/8-16	100	
BDP07	7/16-14	100	
BDP08	1/2-13	50	
BDP10	5/8-11	25	

**GRADE 8 - HIGH HEX NUT**

HEAT TREATED PLAIN STEEL, UNF

Line: 024-00

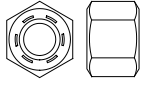

PART NUMBER	SIZE	QTY/BX	LIST PRICE
EBD08	1/2-20	100	
EBD09	9/16-18	50	
EBD10	5/8-18	50	
EBD12	3/4-16	50	
EBD14	7/8-14	25	
EBD16	1-14	25	
EBD18	1 1/8-12	15	
EBD20	1 1/4-12	15	
EBD24	1 1/2-12	10	

**GRADE 8 - HIGH HEX NUT**

HEAT TREATED ZINC PLATED, UNF

Line: 025-00

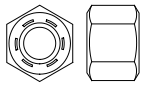

PART NUMBER	SIZE	QTY/BX	LIST PRICE
ECD08	1/2-20	100	
ECD09	9/16-18	50	
ECD10	5/8-18	50	
ECD12	3/4-16	50	
ECD14	7/8-14	25	
ECD16	1-14	25	
ECD18	1 1/8-12	15	
ECD20	1 1/4-12	15	
ECD24	1 1/2-12	10	

**A563-C HEAVY HEX STRUCTURAL NUT**

(A325) PLAIN STEEL, UNC

Line: 026-00

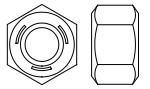

PART NUMBER	SIZE	QTY/BX	LIST PRICE
UHU08	1/2-13	100	
UHU10	5/8-11	50	
UHU12	3/4-10	25	
UHU14	7/8-9	25	
UHU16	1-8	25	
UHU18	1 1/8-7	15	
UHU20	1 1/4-7	15	
UHU22	1 3/8-6	10	
UHU24	1 1/2-6	10	

### A563-C HEAVY HEX STRUCTURAL NUT

(A325) ZINC PLATED, UNC

Line: 027-00

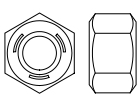

PART NUMBER	SIZE	QTY/BX	LIST PRICE
HKD08	1/2-13	100	
HKD10	5/8-11	50	
HKD12	3/4-10	25	
HKD14	7/8-9	25	
HKD16	1-8	25	
HKD18	1 1/8-7	15	
HKD20	1 1/4-7	15	
HKD22	1 3/8-6	10	
HKD24	1 1/2-6	10	

### HEAVY HEX NUT (GRADE DH)

PLAIN STEEL & HOT-DIP GALVANIZED, UNC

Line: 027-01

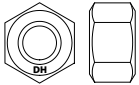

PART NUMBER	SIZE	QTY/BX	LIST PRICE
CGR06	3/8-16	100	
CGR08	1/2-13	100	
CGR08G	1/2-13 (HOT-DIP GALVANIZED)	100	
CGR10	5/8-11	50	
CGR10G	5/8-11 (HOT-DIP GALVANIZED)	50	
CGR12	3/4-10	25	
CGR12G	3/4-10 (HOT-DIP GALVANIZED)	25	
CGR14	7/8-9	25	
CGR14G	7/8-9 (HOT-DIP GALVANIZED)	25	
CGR16	1-8	25	
CGR16G	1-8 (HOT-DIP GALVANIZED)	25	

### HEAVY HEX NUT A194

PLAIN STEEL, UNC - GRADE 2H

Line: 028-00

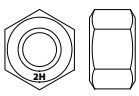

PART NUMBER	SIZE	QTY/BX	LIST PRICE
HHU04	1/4-20	100	
HHU05X	5/16-18	100	
HHU06	3/8-16	100	
HHU07	7/16-14	100	
HHU08	1/2-13	100	
HHU09	9/16-12	50	
HHU10	5/8-11	50	
HHU12	3/4-10	25	
HHU14	7/8-9	25	
HHU16	1-8	25	
HHU18	1 1/8-7	15	
HHU20	1 1/4-7	15	
HHU22	1 3/8-6	10	
HHU24	1 1/2-6	10	
HHU26	1 5/8-5 1/2	5	

### HEAVY HEX NUT A194 (cont.)

PLAIN STEEL, UNC - GRADE 2H

Line: 028-00

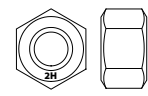

PART NUMBER	SIZE	QTY/BX	LIST PRICE
HHU28	1 3/4-5	5	
HHU32	2-4 1/2	5	
HHU36	2 1/4-4 1/2	1	
HHU40	2 1/2-4	1	
HHU44	2 3/4-4	1	
HHU44JX	2 3/4-4	1	
HHU48	3-4	1	

### HEAVY HEX NUT A194 (GRADE 2H)

PLAIN STEEL, UN8

Line: 029-00

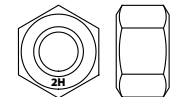

PART NUMBER	SIZE	QTY/BX	LIST PRICE
HHH18	1 1/8-8	15	
HHH20	1 1/4-8	15	
HHH22	1 3/8-8	10	
HHH24	1 1/2-8	10	
HHH26	1 5/8-8	5	
HHH28	1 3/4-8	5	
HHH30	1 7/8-8	5	
HHH32	2-8	5	
HHH36	2 1/4-8	1	
HHH40	2 1/2-8	1	
HHH44	2 3/4-8	1	
HHH48	3-8	1	
HHH56	3 1/2-8	1	

### HEAVY HEAT TREATED WHEEL NUT

ZINC PLATED, UNC

Line: 030-00



PART NUMBER	SIZE	QTY/BX	LIST PRICE
WWW10	5/8-11	50	
WWW12	3/4-10	25	

### HEX MACH SCREW NYLON INSERT LOCK NUT

ZINC PLATED, UNC

Line: 031-00

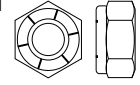

PART NUMBER	SIZE	QTY/BX	LIST PRICE
AWU22X	#2-56	100	
AWU44	#4-40	100	
AWU55	#5-40	100	
AWU66	#6-32 NTM	100	
AWU88	#8-32 NTM	100	
AWU03	#10-24 NTM	100	
AWU21	#12-24 NTM	100	

(continued...)

## HEX MACH SCREW NYLON INSERT LOCK NUT

Zinc Plated, UNF

Line: 032-00

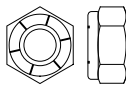

PART NUMBER	SIZE	QTY/BX	LIST PRICE
AWS03	#10-32 NTM	100	

## HEAVY HEX NUT A194 (GRADE 2H)

ZINC PLATED, UNC

Line: 033-00

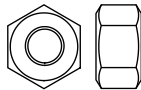

PART NUMBER	SIZE	QTY/BX	LIST PRICE
HHD04	1/4-20	100	
HHD05	5/16-18	100	
HHD06	3/8-16	100	
HHD07	7/16-14	100	
HHD08	1/2-13	100	
HHD09	9/16-12	50	
HHD10	5/8-11	50	
HHD12	3/4-10	25	
HHD14	7/8-9	25	
HHD16	1-8	25	
HHD18	1 1/8-7	15	
HHD20	1 1/4-7	15	
HHD22	1 3/8-6	10	
HHD24	1 1/2-6	10	
HHD28	1 3/4-5	5	
HHD32	2-4 1/2	5	
HHD36	2 1/4-4 1/2	1	

## HEAVY HEX NUT A194 (GRADE 2H)

Zinc Plated, UN8

Line: 034-00



PART NUMBER	SIZE	QTY/BX	LIST PRICE
HJD18	1 1/8-8	15	
HJD20	1 1/4-8	15	
HJD22	1 3/8-8	10	
HJD24	1 1/2-8	10	
HJD28	1 3/4-8	5	
HJD32	2-8	1	

## FIN HEX NYLON INSERT LOCK NUT

GRADE 2 - ZINC PLATED, UNC

Line: 035-00

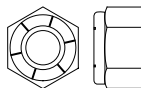

PART NUMBER	SIZE	QTY/BX	LIST PRICE
AVU44	#4-40	100	
AVU55	#5-40	100	
AVU66	#6-32 NM	100	
AVU88	#8-32 NM	100	
AVU03	#10-24 NM	100	
AVU21X	#12-24 NM	100	
AVU04	1/4-20	100	

(continued...)

## FIN HEX NYLON INSERT LOCK NUT (cont.)

GRADE 2 - ZINC PLATED, UNC

Line: 035-00

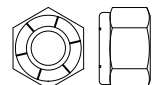

PART NUMBER	SIZE	QTY/BX	LIST PRICE
AVU05	5/16-18	100	
AVU06	3/8-16	100	
AVU07	7/16-14	100	
AVU08	1/2-13	100	
AVU09	9/16-12	50	
AVU10	5/8-11	50	
AVU12	3/4-10	25	
AVU14	7/8-9	25	
AVU16	1-8	25	
AVU18	1 1/8-7	10	
AVU20	1 1/4-7	10	
AVU22	1 3/8-6	10	
AVU24	1 1/2-6	10	

## FINISHED HEX NYLON INSERT LOCK NUT

GRADE 2 - ZINC PLATED, UNF

Line: 036-00

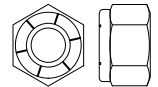

PART NUMBER	SIZE	QTY/BX	LIST PRICE
AVS03	#10-32 NM	100	
AVS04	1/4-28	100	
AVS05	5/16-24	100	
AVS06	3/8-24	100	
AVS07	7/16-20	100	
AVS08	1/2-20	100	
AVS09	9/16-18	50	
AVS10	5/8-18	50	
AVS12	3/4-16	25	
AVS14	7/8-14	25	
AVS16	1-14	25	
AVS18	1 1/8-12	10	
AVS20	1 1/4-12	10	
AVS24	1 1/2-12	10	
AVS32	2-12 (NU Series)	5	

## FIN HEX JAM NYLON INSERT LOCK NUT

GRADE 2 - ZINC PLATED, UNC

Line: 037-00

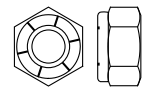

PART NUMBER	SIZE	QTY/BX	LIST PRICE
AXU04	1/4-20	100	
AXU05	5/16-18	100	
AXU06	3/8-16	100	
AXU07	7/16-14	100	
AXU08	1/2-13	100	
AXU09	9/16-12	50	
AXU10	5/8-11	50	

(continued...)



**FIN HEX JAM NYLON INSERT LOCK NUT (cont.)**

GRADE 2 - ZINC PLATED, UNC

Line: 037-00

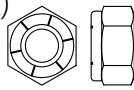

PART NUMBER	SIZE	QTY/BX	LIST PRICE
AXU12	3/4-10	50	
AXU14	7/8-9	25	
AXU16	1-8	25	
AXU20	1 1/4-7	15	
AXU24	1 1/2-6	10	

**FIN HEX JAM NYLON INSERT LOCK NUT**

GRADE 2 - ZINC PLATED, UNF

Line: 038-00

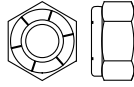

PART NUMBER	SIZE	QTY/BX	LIST PRICE
AXS04	1/4-28	100	
AXS05	5/16-24	100	
AXS06	3/8-24	100	
AXS07	7/16-20	100	
AXS08	1/2-20	100	
AXS09	9/16-18	50	
AXS10	5/8-18	50	
AXS12	3/4-16	50	
AXS14	7/8-14	25	
AXS16	1-14	25	
AXS18	1 1/8-12	15	
AXS20	1 1/4-12	15	
AXS22	1 3/8-12	10	
AXS24	1 1/2-12	10	
AXS32X	2-12 (Heavy)	1	
AXS36X	2 1/4-12 (Heavy)	1	
AXS40X	2 1/2-12 (Plain)	1	

**HEAVY HEX NYLON INSERT LOCK NUT**

GRADE 2 - ZINC PLATED, UNC

Line: 039-00

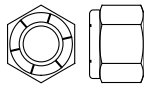

PART NUMBER	SIZE	QTY/BX	LIST PRICE
AGA04	1/4-20	100	
AGA05	5/16-18	100	
AGA06	3/8-16	100	
AGA07	7/16-14	100	
AGA08	1/2-13	100	
AGA09	9/16-12	50	
AGA10	5/8-11	25	
AGA12	3/4-10	25	
AGA14	7/8-9	25	
AGA16	1-8	25	
AGA18	1 1/8-7	15	
AGA20	1 1/4-7	25	
AGA24	1 1/2-6	15	
AGA32	2-4 1/2	1	

**HVY HEX JAM NYLON INSERT LOCK NUT**

GRADE 2 - ZINC PLATED, UNC

Line: 040-00

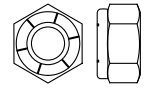

PART NUMBER	SIZE	QTY/BX	LIST PRICE
AHA04	1/4-20	100	
AHA06	3/8-16	100	
AHA07	7/16-14	100	
AHA08	1/2-13	100	
AHA09	9/16-12	50	
AHA10	5/8-11	50	
AHA12	3/4-10	25	
AHA14	7/8-9	25	
AHA16	1-8	25	
AHA18	1 1/8-7	15	
AHA18X	1 1/8-12	15	
AHA24	1 1/2-6 (Plain)	10	
AHA32	2-4 1/2	1	

**HIGH HEX NYLON INSERT LOCK NUT**

ZINC PLATED, UNF

Line: 041-00

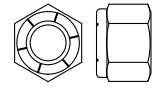

PART NUMBER	SIZE	QTY/BX	LIST PRICE
AJA06	3/8-24	100	
AJA07	7/16-20	100	
AJA08	1/2-20	100	
AJA10	5/8-18	25	
AJA12	3/4-16	25	
AJA14	7/8-14	25	
AJA16	1-14	10	
AJA18	1 1/8-12	10	
AJA20	1 1/4-12	10	

**NYLON INSERT LOCK NUT (GRADE 8)**

ZINC/YELLOW, UNC & UNF

Line: 041-01

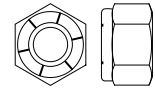

PART NUMBER	SIZE	QTY/BX	LIST PRICE
JXFU04X	1/4-20	100	
JXFS04X	1/4-28	100	
JXFU05X	5/16-18	100	
JXFS05X	5/16-24	100	
JXFU06X	3/8-16	100	
JXFS06X	3/8-24	100	
JXFU07X	7/16-14	100	
JXFS07X	7/16-20	100	
JXFU08X	1/2-13	100	
JXFS08X	1/2-20	100	
JXFU09	9/16-12	50	
JXFS09	9/16-18	50	
JXFU10X	5/8-11	50	
JXFS10X	5/8-18	50	

(continued...)

**CALL: (800) 723-2826**

**NYLON INSERT LOCK NUT (GRADE 8) (cont.)**

ZINC/YELLOW, UNC &amp; UNF

Line: 041-01

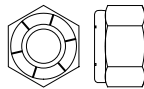

PART NUMBER	SIZE	QTY/BX	LIST PRICE
JXFU12X	3/4-10	50	
JXFS12	3/4-16	50	
JXFU14X	7/8-9	50	
JXFS14	7/8-14	25	
JXFU16X	1-8	25	
JXFS16	1-14	25	
JXFU18X	1 1/8-7	5	
JXFS18	1 1/8-12	1	
JXFU20X	1 1/4-7	10	
JXFS20	1 1/4-12	25	
JXFU22	1 3/8-6	1	
JXFS22	1 3/8-12	1	
JXFU24X	1 1/2-6	10	
JXFS24X	1 1/2-12	10	
JXFU28	1 3/4-5	1	
JXFS28	1 3/4-12	1	
JXFU32	2-4 1/2	1	
JXFS32	2-12	1	

**ALL METAL LOCK NUT (GRADE C)**

CADMIUM/WAX, UNC (PREVAILING TORQUE)

Line: 042-00

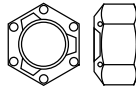

PART NUMBER	SIZE	QTY/BX	LIST PRICE
BRU04	1/4-20	100	
BRU05	5/16-18	100	
BRU06	3/8-16	100	
BRU07	7/16-14	100	
BRU08	1/2-13	100	
BRU09	9/16-12	50	
BRU10	5/8-11	50	
BRU12	3/4-10	25	
BRU14	7/8-9	25	
BRU16	1-8	25	
BRU18	1 1/8-7	15	
BRU20	1 1/4-7	15	
BRU22	1 3/8-6 (Full Collar)	10	
BRU24	1 1/2-6	10	
BRU32	2-4 1/2 (Collar)	5	

**ALL METAL LOCK NUT (GRADE C)**

CADMIUM/WAX, UNF (PREVAILING TORQUE)

Line: 043-00

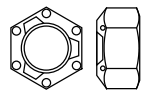

PART NUMBER	SIZE	QTY/BX	LIST PRICE
BRS04	1/4-28	100	
BRS05	5/16-24	100	
BRS06	3/8-24	100	
BRS07	7/16-20	100	
BRS08	1/2-20	100	
BRS09	9/16-18	50	
BRS10	5/8-18	50	
BRS12	3/4-16	25	
BRS14	7/8-14	25	
BRS16	1-14	25	
BRS18	1 1/8-12	15	
BRS20	1 1/4-12	15	
BRS22	1 3/8-12	10	
BRS24	1 1/2-12	10	

**ALL METAL LOCK NUT (GRADE C) - USA**

CADMIUM/WAX, UNC - MADE IN THE USA

Line: 043-01

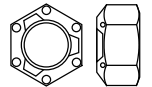

PART NUMBER	SIZE	QTY/BX	LIST PRICE
BDW04	1/4-20	100	
BDW05	5/16-18	100	
BDW06	3/8-16	100	
BDW07	7/16-14	100	
BDW08	1/2-13	100	
BDW09	9/16-12	50	
BDW10	5/8-11	50	
BDW12	3/4-10	50	
BDW14	7/8-9	25	

**ALL METAL LOCK NUT (GRADE C) - USA**

CADMIUM/WAX, UNF - MADE IN THE USA

Line: 043-02

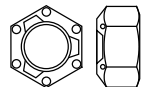

PART NUMBER	SIZE	QTY/BX	LIST PRICE
BDX04	1/4-28	100	
BDX05	5/16-24	100	
BDX06	3/8-24	100	
BDX07	7/16-20	100	
BDX08	1/2-20	100	
BDX09	9/16-18	50	
BDX10	5/8-18	50	
BDX12	3/4-16	50	
BDX14	7/8-14	25	

**CALL - 1 (800) 723-2826**

**ALL METAL LOCK NUT (GRADE B)**

ZINC PLATED, UNC - PREVAILING TORQUE

Line: 044-00

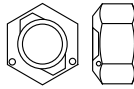

PART NUMBER	SIZE	QTY/BX	LIST PRICE
BSU04	1/4-20	100	
BSU05	5/16-18	100	
BSU06	3/8-16	100	
BSU07	7/16-14	100	
BSU08	1/2-13	100	
BSU09	9/16-12	50	
BSU10	5/8-11	50	
BSU12	3/4-10	25	
BSU14	7/8-9	25	
BSU16	1-8	25	
BSU18	1 1/8-7	15	
BSU20	1 1/4-7	15	

**ALL METAL LOCK NUT (GRADE B)**

ZINC PLATED, UNF - PREVAILING TORQUE

Line: 045-00

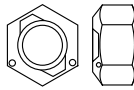

PART NUMBER	SIZE	QTY/BX	LIST PRICE
BSS04	1/4-28	100	
BSS05	5/16-24	100	
BSS06	3/8-24	100	
BSS07	7/16-20	100	
BSS08	1/2-20	100	
BSS09	9/16-18	50	
BSS10	5/8-18	50	
BSS12	3/4-16	25	
BSS14	7/8-14	25	
BSS16	1-14	25	
BSS18	1 1/8-12	15	
BSS20	1 1/4-12	15	

**LIGHT HEX FLEXLOC NUT**

CADMIUM, UNC - FULL HEIGHT

Line: 046-00

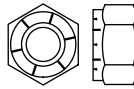

PART NUMBER	SIZE	QTY/BX	LIST PRICE
BTU21FA256	#2-56	100	
BTU21FA348	#3-48	100	
BTU21FA440	#4-40	100	
BTU21FA540	#5-40	100	
BTU21FA632	#6-32	100	
BTU21FA832	#8-32	100	
BTU21FA1024	#10-24	100	
BTU21FA1224	#12-24	100	
BTU21FA420	1/4-20	100	
BTU21FAF518	5/16-18	100	
BTU21FAF616	3/8-16	100	

(continued...)

**LIGHT HEX FLEXLOC NUT (cont.)**

CADMIUM, UNC - FULL HEIGHT

Line: 046-00

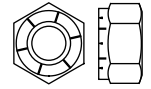

PART NUMBER	SIZE	QTY/BX	LIST PRICE
BTU21FAF714	7/16-14	100	
BTU21FAF813	1/2-13	100	
BTU31FA912	9/16-12	50	
BTU31FAF1011	5/8-11	50	
BTU31FAF1210	3/4-10	50	
BTU31FAF1409	7/8-9	25	
BTU31FAF1608	1-8	25	

**LIGHT HEX FLEXLOC NUT**

PLAIN STEEL, UNC - FULL HEIGHT

Line: 046-01

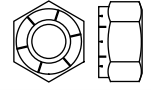

PART NUMBER	SIZE	QTY/BX	LIST PRICE
JJK20FA256	#2-56	100	
JJK20FA348	#3-48	100	
JJK20FA440	#4-40	100	
JJK20FA540	#5-40	100	
JJK20FA632	#6-32	100	
JJK20FA832	#8-32	100	
JJK20FA1024	#10-24	100	
JJK20FA1224	#12-24	100	
JJK20FA420	1/4-20	100	
JJK20FAF518	5/16-18	100	
JJK20FAF616	3/8-16	100	
JJK20FAF714	7/16-14	100	
JJK20FAF813	1/2-13	100	
JJK30FA912	9/16-12	50	
JJK30FAF1011	5/8-11	50	
JJK30FAF1210	3/4-10	50	
JJK30FAF1409	7/8-9	25	
JJK30FAF1608	1-8	25	

**LIGHT HEX FLEXLOC NUT**

CADMIUM, UNC - FULL HEIGHT

Line: 047-00

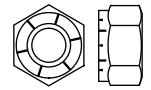

PART NUMBER	SIZE	QTY/BX	LIST PRICE
BTS21FC264	#2-64	100	
BTS21FC356	#3-56	100	
BTS21FC448	#4-48	100	
BTS21FC640	#6-40	100	
BTS21FC836	#8-36	100	
BTS21FC1032	#10-32	100	
BTS21FC1228	#12-28	100	
BTS21FC428	1/4-28	100	
BTS21FC524	5/16-24	100	
BTS21FC624	3/8-24	100	

(continued...)

**LIGHT HEX FLEXLOC NUT (cont.)**

CADMIUM, UNC - FULL HEIGHT

Line: 047-00

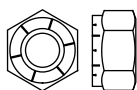

PART NUMBER	SIZE	QTY/BX	LIST PRICE
BTS21FC720	7/16-20	100	
BTS21FC820	1/2-20	100	
BTS31FC918	9/16-18	50	
BTS31FC1018	5/8-18	50	
BTS31FC1216	3/4-16	50	
BTS31FC1414	7/8-14	25	
BTS31FC1612	1-12	25	
BTS31FC1614	1-14	25	
BTS31FC1812	1 1/8-12	25	
BTS31FC2012	1 1/4-12	25	
BTS31FC2212	1 3/8-12	10	
BTS31FC2412	1 1/2-12	10	

**LIGHT HEX FLEXLOC NUT**

PLAIN STEEL, UNC - FULL HEIGHT

Line: 047-01

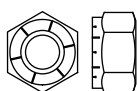

PART NUMBER	SIZE	QTY/BX	LIST PRICE
JKK20FC264	#2-64	100	
JKK20FC356	#3-56	100	
JKK20FC448	#4-48	100	
JKK20FC544	#5-44	100	
JKK20FC640	#6-40	100	
JKK20FC836	#8-36	100	
JKK20FC1032	#10-32	100	
JKK20FC1228	#12-28	100	
JKK20FC428	1/4-28	100	
JKK20FC524	5/16-24	100	
JKK20FC624	3/8-24	100	
JKK20FC720	7/16-20	100	
JKK20FC820	1/2-20	100	
JKK30FC918	9/16-18	50	
JKK30FC1018	5/8-18	50	
JKK30FC1216	3/4-16	50	
JKK30FC1414	7/8-14	25	
JKK30FC1612	1-12	25	
JKK30FC1614	1-14	25	
JKK30FC1812	1 1/8-12	25	
JKK30FC2012	1 1/4-12	25	
JKK30FC2212	1 3/8-12	10	
JKK30FC2412	1 1/2-12	10	

**LIGHT HEX JAM FLEXLOC NUT**

CADMIUM, UNC - THIN HEIGHT

Line: 048-00

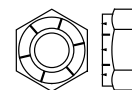

PART NUMBER	SIZE	QTY/BX	LIST PRICE
BUU21FK632	#6-32	100	
BUU21FK832	#8-32	100	
BUU21FK1024	#10-24	100	
BUU21FK420	1/4-20	100	
BUU21FKF518	5/16-18	100	
BUU21FKF616	3/8-16	100	
BUU21FKF714	7/16-14	100	
BUU21FKF813	1/2-13	100	
BUU31FK912	9/16-12	50	
BUU31FKF1011	5/8-11	50	
BUU31FKF1210	3/4-10	50	
BUU31FKF1409	7/8-9	25	
BUU31FKF1608	1-8	25	

**LIGHT HEX JAM FLEXLOC NUT**

PLAIN STEEL, UNC - THIN HEIGHT

Line: 048-01

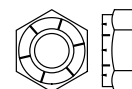

PART NUMBER	SIZE	QTY/BX	LIST PRICE
JLK20FK632	#6-32	100	
JLK20FK832	#8-32	100	
JLK20FK1024	#10-24	100	
JLK20FK420	1/4-20	100	
JLK20FKF518	5/16-18	100	
JLK20FKF616	3/8-16	100	
JLK20FKF714	7/16-14	100	
JLK20FKF813	1/2-13	100	
JLK30FK912	9/16-12	50	
JLK30FKF1011	5/8-11	50	
JLK30FKF1210	3/4-10	50	
JLK30FKF1409	7/8-9	25	
JLK30FKF1608	1-8	25	

**LIGHT HEX JAM FLEXLOC NUT**

CADMIUM, UNF - THIN HEIGHT

Line: 049-00

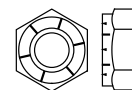

PART NUMBER	SIZE	QTY/BX	LIST PRICE
BUS21FK640	#6-40	100	
BUS21FK1032	#10-32	100	
BUS21FK428	1/4-28	100	
BUS21FK524	5/16-24	100	
BUS21FK624	3/8-24	100	
BUS21FK720	7/16-20	100	
BUS21FK820	1/2-20	100	
BUS31FK1018	5/8-18	50	
BUS31FK1216	3/4-16	50	
BUS31FK1612	1-12	25	

(continued...)

**LIGHT HEX JAM FLEXLOC NUT (cont.)**

CADMIUM, UNF - THIN HEIGHT

Line: 049-00

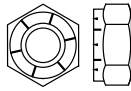

PART NUMBER	SIZE	QTY/BX	LIST PRICE
BUS31FK1812	1 1/8-12	25	
BUS31FK2012	1 1/4-12	25	
BUS31FK2212	1 3/8-12	10	
BUS31FK2412	1 1/2-12	10	

**LIGHT HEX JAM FLEXLOC NUT**

PLAIN STEEL, UNF - THIN HEIGHT

Line: 049-01

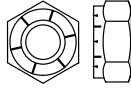

PART NUMBER	SIZE	QTY/BX	LIST PRICE
JMK20FK640	#6-40	100	
JMK20FK836	#8-36	100	
JMK20FK1032	#10-32	100	
JMK20FK428	1/4-28	100	
JMK20FK524	5/16-24	100	
JMK20FK624	3/8-24	100	
JMK20FK820	1/2-20	100	
JMK30FK1018	5/8-18	50	
JMK30FK1216	3/4-16	50	
JMK30FK1614	1-14	25	
JMK30FK1812	1 1/8-12	25	
JMK30FK2012	1 1/4-12	25	
JMK30FK2212	1 3/8-12	10	
JMK30FK2412	1 1/2-12	10	

**HEAVY HEX FLEXLOC NUT**

PLAIN STEEL, UNC - FULL HEIGHT

Line: 050-00

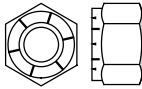

PART NUMBER	SIZE	QTY/BX	LIST PRICE
APA20FAC420	1/4-20	100	
APA20FA518	5/16-18	100	
APA20FA616	3/8-16	100	
APA20FA714	7/16-14	100	
APA20FA813	1/2-13	100	
APA30FAC912	9/16-12	50	
APA30FA1011	5/8-11	50	
APA30FA1210	3/4-10	50	
APA30FA1409	7/8-9	25	
APA30FA1608	1-8	25	
APA30FN1807	1 1/8-7	25	
APA30FN2007	1 1/4-7	25	
APA30FN2406	1 1/2-6	10	
APA30FN2605	1 5/8-5 1/2	5	
APA30FN2805	1 3/4-5	5	
APA30FN3005	1 7/8-5	5	
APA30FN3204	2-4 1/2	5	

**HEAVY HEX FLEXLOC NUT**

CADMIUM, UNC - FULL HEIGHT

Line: 050-01

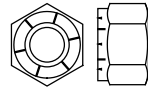

PART NUMBER	SIZE	QTY/BX	LIST PRICE
JNK21FAC420	1/4-20	100	
JNK21FA518	5/16-18	100	
JNK21FA616	3/8-16	100	
JNK21FA813	1/2-13	100	
JNK31FA1011	5/8-11	50	
JNK31FA1210	3/4-10	50	
JNK31FA1409	7/8-9	25	
JNK31FA1608	1-8	25	
JNK31FN1807	1 1/8-7	25	
JNK31FN2007	1 1/4-7	25	
JNK31FN2206	1 3/8-6	10	
JNK31FN2406	1 1/2-6	10	
JNK31FN2605	1 5/8-5 1/2	5	
JNK31FN2805	1 3/4-5	5	
JNK31FN3005	1 7/8-5	5	
JNK31FN3204	2-4 1/2	5	

**HEAVY HEX JAM FLEXLOC NUT**

PLAIN STEEL, UNC - THIN HEIGHT

Line: 051-00

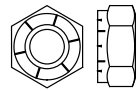

PART NUMBER	SIZE	QTY/BX	LIST PRICE
AUA20FK518	5/16-18	100	
AUA20FK616	3/8-16	100	
AUA20FK813	1/2-13	100	
AUA30FKC912	9/16-12	50	
AUA30FK1011	5/8-11	50	
AUA30FK1210	3/4-10	50	
AUA30FK1409	7/8-9	25	
AUA30FK1608	1-8	25	
AUA30FK1807	1 1/8-7	25	
AUA30FK2007	1 1/4-7	10	
AUA30FK2206	1 3/8-6	10	
AUA30FK2406	1 1/2-6	10	

**HEAVY HEX JAM FLEXLOC NUT**

CADMIUM, UNC - THIN HEIGHT

Line: 051-01

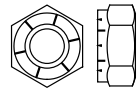

PART NUMBER	SIZE	QTY/BX	LIST PRICE
JPK21FKC420	1/4-20	100	
JPK21FK518	5/16-18	100	
JPK21FK616	3/8-16	100	
JPK21FK714M10	7/16-14	10	
JPK21FK813	1/2-13	100	
JPK31FKC912	9/16-12	50	
JPK31FK1011	5/8-11	50	
JPK31FK1210	3/4-10	50	

(continued...)

### HEAVY HEX JAM FLEXLOC NUT (cont.)

CADMIUM, UNC - THIN HEIGHT

Line: 051-01

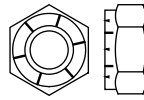

PART NUMBER	SIZE	QTY/BX	LIST PRICE
JPK31FK1409	7/8-9	25	
JPK31FK1608	1-8	25	
JPK31FK1807	1 1/8-7	25	
JPK31FK2007	1 1/4-7	10	
JPK31FK2206	1 3/8-6	10	
JPK31FK2406	1 1/2-6	10	

### ALL METAL 2-WAY CENTER LOCK NUT

ZINC PLATED, UNC - GRADE A

Line: 052-00



PART NUMBER	SIZE	QTY/BX	LIST PRICE
BXU88	#8-32	100	
BXU04	1/4-20	100	
BXU05	5/16-18	100	
BXU06	3/8-16	100	
BXU07	7/16-14	100	
BXU08	1/2-13	100	
BXU09	9/16-12	50	
BXU10	5/8-11	50	
BXU12	3/4-10	50	
BXU14	7/8-9	25	
BXU16	1-8	25	

### ALL METAL 2-WAY CENTER LOCK NUT

ZINC PLATED, UNF - GRADE A

Line: 053-00



PART NUMBER	SIZE	QTY/BX	LIST PRICE
BXS04	1/4-28	100	
BXS05	5/16-24	100	
BXS06	3/8-24	100	
BXS07	7/16-20	100	
BXS08	1/2-20	100	
BXS09	9/16-18	50	
BXS10	5/8-18	50	
BXS12	3/4-16	50	
BXS14	7/8-14	25	
BXS16	1-14	25	

### HEX "K" LOCK NUT (KEPS)

ZINC PLATED, UNC

Line: 054-00

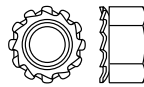

PART NUMBER	SIZE	QTY/BX	LIST PRICE
BCU44	#4-40	100	
BCU55	#5-40	100	
BCU66	#6-32	100	
BCU88	#8-32	100	
BCU03	#10-24	100	

(continued...)

### HEX "K" LOCK NUT (KEPS) (cont.)

ZINC PLATED, UNC

Line: 054-00

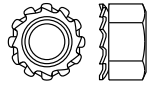

PART NUMBER	SIZE	QTY/BX	LIST PRICE
BCU21	#12-24	100	
BCU04	1/4-20	100	
BCU05	5/16-18	100	
BCU06	3/8-16	100	

### HEX "K" LOCK NUT (KEPS)

ZINC PLATED, UNF

Line: 055-00

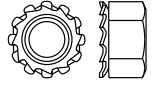

PART NUMBER	SIZE	QTY/BX	LIST PRICE
BCS03	#10-32	100	
BCS04	1/4-28	100	
BCS05	5/16-24	100	
BCS06	3/8-24	100	

### GRADE 2 FINISHED HEX CASTLE NUT

ZINC PLATED, UNF

Line: 059-00

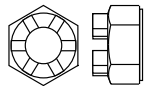

PART NUMBER	SIZE	QTY/BX	LIST PRICE
KKS04	1/4-28	100	
KKS05	5/16-24	100	
KKS06	3/8-24	100	
KKS07	7/16-20	100	
KKS08	1/2-20	100	
KKS09	9/16-18	50	
KKS10	5/8-18	50	
KKS12	3/4-16	25	
KKS14	7/8-14	25	
KKS16	1-14	25	
KKS16G5	1-14 (Grade 5)	25	
KKS18	1 1/8-12	15	
KKS20	1 1/4-12	15	
KKS22	1 3/8-12	10	
KKS24	1 1/2-12	10	
KKS28	1 3/4-12	5	
KKS32	2-12	5	

### GRADE 2 FINISHED HEX CASTLE NUT

PLAIN STEEL, UNC

Line: 060-00

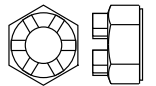

PART NUMBER	SIZE	QTY/BX	LIST PRICE
LLU05	5/16-18	100	
LLU06	3/8-16	100	
LLU07	7/16-14	100	
LLU08	1/2-13	100	
LLU09	9/16-12	50	
LLU10	5/8-11	50	
LLU12	3/4-10	25	

(continued...)

**GRADE 2 FINISHED HEX CASTLE NUT (cont.)**

PLAIN STEEL, UNC

Line: 060-00

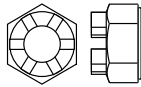

PART NUMBER	SIZE	QTY/BX	LIST PRICE
LLU14	7/8-9	25	
LLU16	1-8	25	
LLU18	1 1/8-7	15	
LLU20	1 1/4-7	15	
LLU22	1 3/8-6	10	
LLU24	1 1/2-6	10	

**GRADE 2 FINISHED HEX CASTLE NUT**

PLAIN STEEL, UNF

Line: 061-00

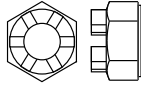

PART NUMBER	SIZE	QTY/BX	LIST PRICE
LLS04	1/4-28	100	
LLS05	5/16-24	100	
LLS06	3/8-24	100	
LLS07	7/16-20	100	
LLS08	1/2-20	100	
LLS09	9/16-18	50	
LLS10	5/8-18	50	
LLS12	3/4-16	25	
LLS14	7/8-14	25	
LLS16	1-14	25	
LLS18	1 1/8-12	15	
LLS20	1 1/4-12	15	
LLS22	1 3/8-12	10	
LLS24	1 1/2-12	10	
LLS28	1 3/4-12	5	
LLS32	2-12	5	

**GRADE 2 FINISHED HEX SLOTTED NUT**

PLAIN STEEL, UNC

Line: 062-00

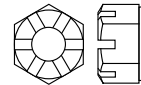

PART NUMBER	SIZE	QTY/BX	LIST PRICE
NNU04X	1/4-20	100	
NNU05X	5/16-18	100	
NNU06	3/8-16	100	
NNU07	7/16-14	100	
NNU08	1/2-13	100	
NNU09	9/16-12	50	
NNU10	5/8-11	50	
NNU12	3/4-10	25	
NNU14	7/8-9	25	
NNU16	1-8	25	
NNU18	1 1/8-7	15	
NNU20	1 1/4-7	15	
NNU22	1 3/8-6	10	
NNU24	1 1/2-6	10	

(continued...)

**GRADE 2 FINISHED HEX SLOTTED NUT (cont.)**

PLAIN STEEL, UNC

Line: 062-00

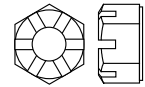

PART NUMBER	SIZE	QTY/BX	LIST PRICE
NNU28	1 3/4-5	5	
NNU40	2 1/2-4	1	

**GRADE 2 FINISHED HEX SLOTTED NUT**

PLAIN STEEL, UNF

Line: 063-00

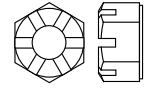

PART NUMBER	SIZE	QTY/BX	LIST PRICE
NNS06	3/8-24	100	
NNS07	7/16-20	100	
NNS08	1/2-20	100	
NNS09	9/16-18	50	
NNS10	5/8-18	50	
NNS12	3/4-16	25	
NNS14	7/8-14	25	
NNS16	1-14	25	
NNS18	1 1/8-12	15	
NNS20	1 1/4-12	25	
NNS22	1 3/8-12	15	
NNS24	1 1/2-12	10	
NNS28	1 3/4-12	5	
NNS32	2-12	5	

**GRADE 2 HEAVY HEX SLOTTED NUT**

PLAIN STEEL, UNC

Line: 066-00

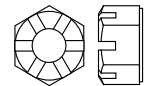

PART NUMBER	SIZE	QTY/BX	LIST PRICE
AEA06	3/8-16	100	
AEA07	7/16-14	100	
AEA08	1/2-13	100	
AEA10	5/8-11	50	
AEA12	3/4-10	25	
AEA14	7/8-9	25	
AEA16	1-8	25	
AEA18	1 1/8-7	15	
AEA20	1 1/4-7	15	
AEA22	1 3/8-6	10	
AEA24	1 1/2-6	10	
AEA28	1 3/4-5	5	
AEA32	2-4 1/2	5	

## GRADE 2 FINISHED HEX SLOTTED NUT

ZINC PLATED, UNF

Line: 068-00

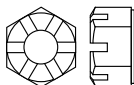

PART NUMBER	SIZE	QTY/BX	LIST PRICE
DYD06	3/8-24	100	
DYD07	7/16-20	100	
DYD08	1/2-20	100	
DYD09	9/16-18	50	
DYD10	5/8-18	50	
DYD12	3/4-16	25	
DYD14	7/8-14	25	
DYD16	1-14	25	
DYD18	1 1/8-12	15	
DYD20	1 1/4-12	15	
DYD22	1 3/8-12	10	
DYD24	1 1/2-12	10	

## STAMPED WING NUT

ZINC PLATED, UNC

Line: 071-00



PART NUMBER	SIZE	QTY/BX	LIST PRICE
AYU66	#6-32	100	
AYU88	#8-32	100	
AYU03	#10-24	100	
AYU04	1/4-20	100	
AYU05	5/16-18	100	
AYU06	3/8-16	100	

## COLD FORGED WING NUT

ZINC PLATED, UNC

Line: 072-00

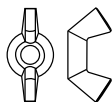

PART NUMBER	SIZE	QTY/BX	LIST PRICE
AZU66	#6-32	100	
AZU88	#8-32	100	
AZU03	#10-24	100	
AZU21	#12-24	100	
AZU04	1/4-20	100	
AZU05	5/16-18	100	
AZU06	3/8-16	100	
AZU07	7/16-14	50	
AZU08	1/2-13	50	
AZU10	5/8-11	25	
AZU12X	3/4-10	25	

## COLD FORGED WING NUT

ZINC PLATED, UNF

Line: 073-00

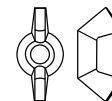

PART NUMBER	SIZE	QTY/BX	LIST PRICE
AZS03	#10-32	100	
AZS04	1/4-28	100	
AZS05	5/16-24	100	
AZS06	3/8-24	100	
AZS08	1/2-20	50	

## ACORN CAP NUT (2 PIECE, PRESSED)

NICKEL PLATED, UNC

Line: 078-00



PART NUMBER	SIZE	QTY/BX	LIST PRICE
BDU66	#6-32	100	
BDU88	#8-32	100	
BDU03	#10-24	100	
BDU04	1/4-20	100	
BDU05	5/16-18	100	
BDU06	3/8-16	100	
BDU08	1/2-13	100	
BDU10	5/8-11	50	

## ACORN CAP NUT (2 PIECE, PRESSED)

NICKEL PLATED, UNF

Line: 079-00

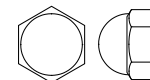

PART NUMBER	SIZE	QTY/BX	LIST PRICE
BDS03	#10-32	100	
BDS04	1/4-28	100	

## ACORN CAP NUT (MILLED)

ZINC PLATED, UNC

Line: 080-00

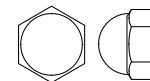

PART NUMBER	SIZE	QTY/BX	LIST PRICE
BEU66	#6-32	100	
BEU88	#8-32	100	
BEU03	#10-24	100	
BEU21X	#12-24	100	
BEU04	1/4-20	100	
BEU05	5/16-18	100	
BEU06	3/8-16	100	
BEU07	7/16-14	50	
BEU08	1/2-13	50	
BEU10	5/8-11	50	
BEU12	3/4-10	25	
BEU14Q15P	7/8-9 (Plain)	15	
BEU16Q10P	1-8 (Plain)	10	



CALL - 1 (800) 723-2826



**ACORN CAP NUT (MILLED)**

ZINC PLATED, UNF  
Line: 081-00

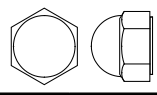

PART NUMBER	SIZE	QTY/BX	LIST PRICE
BES03	#10-32	100	
BES04	1/4-28	100	
BES05	5/16-24	100	
BES06	3/8-24	100	
BES07	7/16-20	50	
BES08	1/2-20	50	
BES10	5/8-18	50	
BES12	3/4-16	25	

**GRADE 2 HEX ROD COUPLING NUT**

ZINC PLATED, UNC & UNF  
Line: 084-00

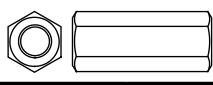

PART NUMBER	SIZE	QTY/BX	LIST PRICE
ALA03	#10-24 X 3/4 (5/16 AF)	100	
ALA04	1/4-20 X 7/8 (3/8 AF)	50	
ALA04F	1/4-28 X 7/8 (3/8 AF)	50	
ALA05	5/16-18 X 1 1/8 (1/2 AF)	50	
ALA05F	5/16-24 X 7/8 (7/16 AF)	50	
ALA05056	5/16-18 X 1 3/4 (1/2 AF)	50	
ALA06	3/8-16 X 1 3/4 (5/8 AF)	50	
ALA06F	3/8-24 X 1 1/8 (1/2 AF)	50	
ALA06036	3/8-16 X 1 1/8 (1/2 AF)	100	
ALA06916	3/8-16 X 1 3/4 (9/16 AF)	50	
ALA07	7/16-14 X 1 3/4 (5/8 AF)	50	
ALA07F	7/16-20 X 1 1/4 (9/16 AF)	50	
ALA08	1/2-13 X 1 3/4 (11/16 AF)	50	
ALA08F	1/2-20 X 1 1/4 (5/8 AF)	50	
ALA08P	1/2-13 X 1 3/4 (11/16 AF, Plain)	50	
ALA08040	1/2-13 x 1 1/4 (5/8 AF)	50	
ALA10	5/8-11 X 2 1/8 (13/16 AF)	25	
ALA10F	5/8-18 x 2 1/8 (13/16 AF)	25	
ALA10P	5/8-11 x 2 1/8 (13/16 AF, Plain)	25	
ALA12	3/4-10 x 2 1/4 (1" AF)	25	
ALA12Q20	3/4-10 x 2 1/4 (1" AF)	20	
ALA12Q20P	3/4-10 x 2 1/4 (1" AF, Plain)	20	
ALA14	7/8-9 x 2 1/2 (1 1/4 AF)	25	
ALA16	1-8 x 2 3/4 (1 3/8 AF)	15	
ALA18	1 1/8-7 x 3 (1 1/2 AF)	10	
ALA18UN8	1 1/8-8 x 3 (1 1/2 AF)	10	
ALA20	1 1/4-7 x 3 (1 5/8 AF)	10	
ALA22	1 3/8-6	1	
ALA24	1 1/2-6 x 4 (2" AF)	5	

**GRADE 2 FINISHED HEX NUT**

HOT-DIP GALVANIZED, UNC  
Line: 085-00

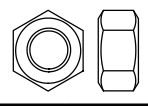

PART NUMBER	SIZE	QTY/BX	LIST PRICE
AWA04	1/4-20	100	
AWA05	5/16-18	100	
AWA06	3/8-16	100	
AWA07	7/16-14	100	
AWA08	1/2-13	100	
AWA10	5/8-11	50	
AWA12	3/4-10	50	
AWA14	7/8-9	25	
AWA16	1-8	25	

**GRADE 2 HEAVY HEX NUT**

HOT-DIP GALVANIZED, UNC  
Line: 086-00



PART NUMBER	SIZE	QTY/BX	LIST PRICE
AXA06X	3/8-16	100	
AXA08	1/2-13	100	
AXA10	5/8-11	50	
AXA12	3/4-10	25	
AXA14	7/8-9	25	
AXA16X	1-8	25	
AXA18	1 1/8-7	25	
AXA20X	1 1/4-7	15	
AXA22	1 3/8-6	10	
AXA24	1 1/2-6	10	
AXA28	1 3/4-5	5	
AXA32	2-4 1/2	1	

**HEAVY HEX NUT (GRADE 2H)**

HOT-DIP GALVANIZED, UNC  
Line: 086-01

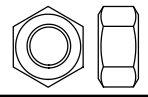

PART NUMBER	SIZE	QTY/BX	LIST PRICE
BDY06	3/8-16	100	
BDY08	1/2-13	100	
BDY10	5/8-11	50	
BDY12	3/4-10	50	
BDY14	7/8-9	25	
BDY16	1-8	25	
BDY18	1 1/8-7	25	
BDY18UN8	1 1/8-8 UN8	25	
BDY20	1 1/4-7	20	
BDY20UN8	1 1/4-8 UN8	20	
BDY22	1 3/8-6	10	
BDY22UN8	1 3/8-8 UN8	10	
BDY24	1 1/2-6	10	
BDY24UN8	1 1/2-8 UN8	10	
BDY28	1 3/4-5	5	
BDY32	2-4 1/2	1	

## SQUARE MACHINE SCREW NUT

ZINC PLATED, UNC

Line: 087-00

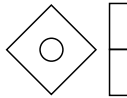

PART NUMBER	SIZE	QTY/BX	LIST PRICE
ARA22	#2-56	100	
ARA33	#3-48	100	
ARA44	#4-40	100	
ARA55X	#5-40	100	
ARA66	#6-32	100	
ARA88	#8-32	100	
ARA02	#10-32	100	
ARA03	#10-24	100	
ARA21X	#12-24	100	
ARA04	1/4-20	100	
ARA05	5/16-18	100	
ARA06	3/8-16	100	
ARA08	1/2-13	100	

## GRADE 2 REGULAR SQUARE NUT

PLAIN STEEL, UNC

Line: 089-00

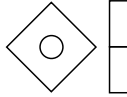

PART NUMBER	SIZE	QTY/BX	LIST PRICE
ATA04	1/4-20	100	
ATA05	5/16-18	100	
ATA06	3/8-16	100	
ATA07	7/16-14	100	
ATA08	1/2-13	100	
ATA10	5/8-11	50	
ATA12	3/4-10	50	
ATA14	7/8-9	25	
ATA16	1-8	25	
ATA18	1 1/8-7	25	
ATA20	1 1/4-7	25	
ATA22X	1 3/8-6	10	
ATA24	1 1/2-6	10	

## GRADE 2 REGULAR SQUARE NUT

ZINC PLATED, UNC

Line: 091-00

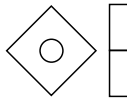

PART NUMBER	SIZE	QTY/BX	LIST PRICE
DMD04	1/4-20	100	
DMD05	5/16-18	100	
DMD06	3/8-16	100	
DMD07	7/16-14	100	
DMD08	1/2-13	100	
DMD10	5/8-11	50	
DMD12	3/4-10	50	
DMD14	7/8-9	25	
DMD16	1-8	25	
DMD18	1 1/8-7	25	

## GRADE 2 REGULAR SQUARE NUT (cont.)

ZINC PLATED, UNC

Line: 091-00

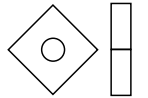

PART NUMBER	SIZE	QTY/BX	LIST PRICE
DMD20	1 1/4-7	25	
DMD24	1 1/2-6	10	

## PRONGED TEE NUT

ZINC PLATED

Line: 092-00

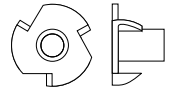

PART NUMBER	SIZE	QTY/BX	LIST PRICE
AQA66	#6-32 (9/32 Barrel 3P)	100	
AQA88	#8-32 (1/4 Barrel 3P)	100	
AQA02	#10-32 (5/16 Barrel 3P)	100	
AQA03	#10-24 (5/16 Barrel 3P)	100	
AQA03SS	#10-24 (Stainless)	100	
AQAS04X	1/4-28	100	
AQA04	1/4-20 (7/16 Barrel 3P)	100	
AQA04SS	1/4-20 (Stainless 4P)	100	
AQA0410	1/4-20 (5/16 Barrel 3P)	100	
AQA05	5/16-18 (3/8 Barrel 3P)	100	
AQA05SPECX	5/16-18 (5/8 Barrel)	100	
AQA06	3/8-16 (7/16 Barrel 3P)	100	

## SERRATED FLANGE HEX NUT

ZINC PLATED, UNC - CASE HARDENED STEEL

Line: 095-00

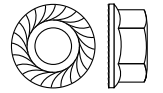

PART NUMBER	SIZE	QTY/BX	LIST PRICE
ZLB66	#6-32	100	
ZLB88	#8-32	100	
ZLBS03	#10-32	100	
ZLB03	#10-24	100	
ZLB04L	1/4-20 (Large Hex)	100	
ZLB3804	1/4-28	100	
ZLB830	1/4-20	100	
ZLB866	5/16-18	100	
ZLB867	5/16-24	100	
ZLB868	3/8-16	100	
ZLB879	3/8-24	50	
ZLB075	7/16-20	100	
ZLB2660	7/16-14	50	
ZLB3806	1/2-13	50	
ZLB3807	1/2-20	50	
ZLB10	5/8-11	50	
ZLB105	5/8-18	50	

(continued...)

### LEFT HAND FINISHED HEX NUT

PLAIN STEEL, UNC

Line: 096-00

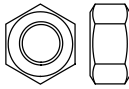

PART NUMBER	SIZE	QTY/BX	LIST PRICE
BNU04	1/4-20	100	
BNU05	5/16-18	100	
BNU06	3/8-16	100	
BNU07	7/16-14	100	
BNU08	1/2-13	100	
BNU09	9/16-12	50	
BNU10	5/8-11	50	
BNU12	3/4-10	25	
BNU14	7/8-9	25	
BNU16	1-8	25	
BNU18	1 1/8-7	10	
BNU20	1 1/4-7	10	
BNU24	1 1/2-6	5	
BNU32	2-4 1/2	5	

### LEFT HAND FINISHED HEX NUT

PLAIN STEEL, UNF

Line: 097-00

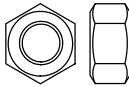

PART NUMBER	SIZE	QTY/BX	LIST PRICE
BNS04	1/4-28	100	
BNS05	5/16-24	100	
BNS06	3/8-24	100	
BNS07	7/16-20	100	
BNS08	1/2-20	100	
BNS09	9/16-18	50	
BNS10	5/8-18	50	
BNS12	3/4-16	25	
BNS14	7/8-14	25	
BNS16	1-14	25	
BNS18	1 1/8-12	10	
BNS20	1 1/4-12	10	
BNS24	1 1/2-12	5	

### LEFT HAND FINISHED HEX JAM NUT

PLAIN STEEL, UNC

Line: 098-00

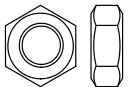

PART NUMBER	SIZE	QTY/BX	LIST PRICE
BPU04	1/4-20	100	
BPU05	5/16-18	100	
BPU06	3/8-16	100	
BPU07	7/16-14	100	
BPU08	1/2-13	100	
BPU09	9/16-12	50	
BPU10	5/8-11	50	
BPU12	3/4-10	25	
BPU14	7/8-9	25	

(continued...)

### LEFT HAND FINISHED HEX JAM NUT (cont.)

PLAIN STEEL, UNC

Line: 098-00

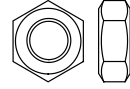

PART NUMBER	SIZE	QTY/BX	LIST PRICE
BPU16	1-8	25	
BPU18	1 1/8-7	10	
BPU20	1 1/4-7	10	
BPU22	1 3/8-6	10	
BPU24	1 1/2-6	5	
BPU28	1 3/4-5	5	
BPU32	2-4 1/2	5	

### LEFT HAND FINISHED HEX JAM NUT

PLAIN STEEL, UNF

Line: 099-00

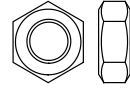

PART NUMBER	SIZE	QTY/BX	LIST PRICE
BPS04	1/4-28	100	
BPS05	5/16-24	100	
BPS06	3/8-24	100	
BPS07	7/16-20	100	
BPS08	1/2-20	100	
BPS09	9/16-18	50	
BPS10	5/8-18	50	
BPS12	3/4-16	25	
BPS14	7/8-14	25	
BPS16	1-14	25	
BPS18	1 1/8-12	10	
BPS20	1 1/4-12	10	
BPS22	1 3/8-12	5	
BPS24	1 1/2-12	5	
BPS26	1 5/8-12	1	
BPS28	1 3/4-12	5	
BPS32	2-12	5	

### LEFT HAND HEAVY HEX NUT

PLAIN STEEL, UNC

Line: 100-00

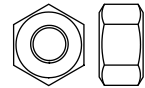

PART NUMBER	SIZE	QTY/BX	LIST PRICE
AMA05X	5/16-18	100	
AMA06	3/8-16	100	
AMA07	7/16-14	100	
AMA08	1/2-13	100	
AMA09	9/16-12	100	
AMA10	5/8-11	50	
AMA12	3/4-10	25	
AMA14	7/8-9	25	
AMA16	1-8	25	
AMA18	1 1/8-7	25	
AMA20	1 1/4-7	10	
AMA24	1 1/2-6	5	

**CALL: (800) 723-2826**

# SECTION 2 PRODUCT INDEX

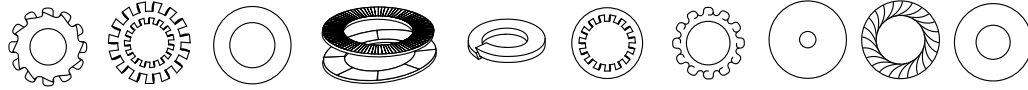

Line Description	Alpha	Line#	Page#
USS FLAT WASHER - PLAIN FINISH - 5LB PACK	CAU	102-00	2-3
USS FLAT WASHER (USA) - ZINC PLATED - PIECE COUNT	CBU	103-00	2-3
USS FLAT WASHER - ZINC PLATED - PIECE COUNT	CCR	103-05	2-3
SAE FLAT WASHER - ZINC PLATED - PIECE COUNT	CCT	103-06	2-3
USS FLAT WASHER - PLAIN FINISH - PIECE COUNT	HLD	104-00	2-3
USS FLAT WASHER - ZINC PLATED - 1LB PACK	HMD	105-00	2-4
SAE FLAT WASHER (USA) - ZINC PLATED - PIECE COUNT	CBS	107-00	2-4
SAE FLAT WASHER - PLAIN FINISH - PIECE COUNT	HND	108-00	2-4
SAE FLAT WASHER - ZINC PLATED - 1LB PACK	HPD	109-00	2-5
FENDER WASHER - ZINC PLATED - PIECE COUNT	AZA	110-00	2-5
FENDER WASHER - THICK GAUGE - ZINC PLATED - PIECE COUNT (USA)	BYN	110-01	2-5
USS FLAT WASHER - THRU HARDENED - YELLOW/ZINC - PIECE COUNT	BBA	111-00	2-6
USS FLAT WASHER - THICK GAUGE - THRU HARD - YEL/ZINC - PIECE COUNT	BYP	111-01	2-6
USS FLAT WASHER - THRU HARDENED - PLAIN FINISH - PIECE COUNT	CDD	111-05	2-6
USS MEGA THICK FLAT WASHER - THRU HARD - YEL/ZINC - PIECE COUNT	FAT	111-10	2-6
SAE MEGA THICK FLAT WASHER - THRU HARD - YEL/ZINC - PIECE COUNT (USA)	MEG	111-11	2-6
A325 STRUCTURAL FLAT WASHER - PLAIN FINISH - PIECE COUNT	BAA	112-00	2-6
A325 STRUCTURAL FLAT WASHER - H.D. GALV - PIECE COUNT	ASK	112-01	2-7
SAE THICK FLAT WASHER - THRU HARDENED - YEL/ZINC - PIECE COUNT (USA)	BYR	112-99	2-7
SAE FLAT WASHER - THRU HARDENED - YELLOW/ZINC - PIECE COUNT	HGD	113-00	2-7
USS FLAT WASHER - HOT DIPPED GALVANIZED - PIECE COUNT	ANP	113-02	2-7
SQUARE PLATE WASHER - HOT DIPPED GALVANIZED - PIECE COUNT	BMN	113-03	2-8
REGULAR SPLIT LOCK WASHER - ZINC PLATED - PIECE COUNT	BCA	114-00	2-8
REGULAR SPLIT LOCK WASHER - ZINC PLATED - 100 PIECE COUNT	BCA/C	114-01	2-8
ALLOY HI-STRENGTH LOCK WASHER - YELLOW/ZINC - PIECE COUNT	BXJ	114-10	2-8
REGULAR SPLIT LOCK WASHER - PLAIN FINISH - PIECE COUNT	BDA	115-00	2-8
REGULAR SPLIT LOCK WASHER - HOT DIPPED GALVANIZED - PIECE COUNT	ANR	115-01	2-9
HIGH COLLAR LOCK WASHER - PLAIN FINISH - PIECE COUNT	BEA	116-00	2-9
HIGH COLLAR LOCK WASHER - ZINC PLATED - PIECE COUNT	DXD	117-00	2-9
LOCK SET WASHER PAIRS - YELLOW ZINC - SOLD PER PAIR	ATM	117-01	2-10
INTERNAL TOOTH LOCK WASHER - ZINC PLATED - PIECE COUNT	BFA	118-00	2-10
EXTERNAL TOOTH LOCK WASHER - ZINC PLATED - PIECE COUNT	BGA	119-00	2-10
INTERNAL/EXTERNAL TOOTH LOCK WASHER - ZINC PLATED - PIECE COUNT	BHA	120-00	2-10
EXTERNAL COUNTERSUNK TOOTH LOCK WASHER - ZINC - PIECE COUNT	BJA	121-00	2-11
A325 HARDENED BEVEL WASHER - PLAIN FINISH	CJA	124-00	2-11
MALLEABLE BEVEL WASHER - PLAIN FINISH	CKA	125-00	2-11
MALLEABLE BEVEL WASHER - HOT DIPPED GALVANIZED	CLA	126-00	2-11
REGULAR MACHINERY BUSHING - 18 GAUGE - PLAIN FINISH	BZA	129-00	2-11
REGULAR MACHINERY BUSHING - 14 GAUGE - PLAIN FINISH	CAA	130-00	2-11
REGULAR MACHINERY BUSHING - 10 GAUGE - PLAIN FINISH	CBA	131-00	2-12

# SECTION 2 PRODUCT INDEX

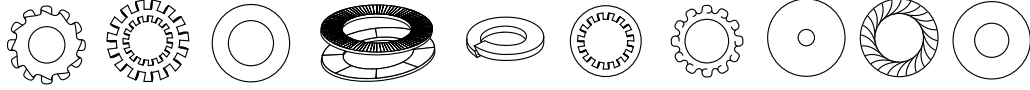

Line Description	Alpha	Line#	Page#
REGULAR MACHINERY BUSHING - 3/16 THICK - PLAIN FINISH	<b>CCA</b>	<b>132-00</b>	2-12
WIDE MACHINERY BUSHING - 18 GAUGE - PLAIN FINISH	<b>CDA</b>	<b>133-00</b>	2-12
WIDE MACHINERY BUSHING - 14 GAUGE - PLAIN FINISH	<b>CEA</b>	<b>134-00</b>	2-12
WIDE MACHINERY BUSHING - 10 GAUGE - PLAIN FINISH	<b>CFA</b>	<b>135-00</b>	2-12
BRASS FINISHING WASHER - NICKEL PLATED	<b>DKD</b>	<b>136-00</b>	2-12
COUNTERSUNK STEEL FINISHING WASHER - NICKEL PLATED	<b>APH</b>	<b>136-05</b>	2-13
COUNTERSUNK STEEL FINISHING WASHER - ZINC PLATED	<b>CGS</b>	<b>136-06</b>	2-13
T-SLOT WASHER - HEAT TREATED	<b>JGD</b>	<b>137-00</b>	2-13



**CALL - 1 (800) 723-2826**

### GRADE 2 USS FLAT WASHER

PLAIN STEEL, 5 LBS./BOX

Line: 102-00

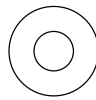

PART NUMBER	SIZE	QTY/BX	LIST PRICE
CAU03	3/16	5 LBS.	
CAU04	1/4	5 LBS.	
CAU05	5/16	5 LBS.	
CAU06	3/8	5 LBS.	
CAU07	7/16	5 LBS.	
CAU08	1/2	5 LBS.	
CAU09	9/16	5 LBS.	
CAU10	5/8	5 LBS.	
CAU12	3/4	5 LBS.	
CAU14	7/8	5 LBS.	
CAU16	1"	5 LBS.	
CAU18	1 1/8	5 LBS.	
CAU20	1 1/4	5 LBS.	
CAU22	1 3/8	5 LBS.	
CAU24	1 1/2	5 LBS.	
CAU26	1 5/8	5 LBS.	
CAU28	1 3/4	5 LBS.	
CAU32	2"	5 LBS.	

### GRADE 2 USS FLAT WASHER

ZINC PLATED, MADE IN THE USA

Line: 103-00



PART NUMBER	SIZE	QTY/BX	LIST PRICE
CBU03	3/16	100	
CBU04	1/4	100	
CBU05	5/16	100	
CBU06	3/8	100	
CBU07	7/16	100	
CBU08	1/2	100	
CBU09	9/16	50	
CBU10	5/8	50	
CBU12	3/4	50	
CBU14	7/8	25	
CBU16	1"	25	
CBU18	1 1/8	25	
CBU20	1 1/4	25	
CBU22	1 3/8	25	
CBU24	1 1/2	25	
CBU26	1 5/8	25	
CBU28	1 3/4	25	
CBU30	1 7/8	25	
CBU32	2"	10	
CBU36	2 1/4	10	
CBU40	2 1/2	10	
CBU48	3"	10	

### GRADE 2 USS FLAT WASHER

ZINC PLATED

Line: 103-05

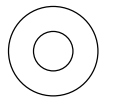

PART NUMBER	SIZE	QTY/BX	LIST PRICE
CCR03	3/16	100	
CCR04	1/4	100	
CCR05	5/16	100	
CCR06	3/8	100	
CCR07	7/16	100	
CCR08	1/2	100	
CCR09	9/16	50	
CCR10	5/8	50	
CCR12	3/4	50	
CCR14	7/8	25	
CCR16	1"	25	

### GRADE 2 SAE FLAT WASHER

ZINC PLATED

Line: 103-06

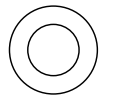

PART NUMBER	SIZE	QTY/BX	LIST PRICE
CCT066	#6	100	
CCT88	#8	100	
CCT88MS	#8 (MACHINE SCREW PATTERN)	100	
CCT03	#10	100	
CCT04	1/4	100	
CCT05	5/16	100	
CCT06	3/8	100	
CCT07	7/16	100	
CCT08	1/2	100	
CCT09	9/16	50	
CCT10	5/8	50	
CCT12	3/4	50	
CCT14	7/8	25	
CCT16	1"	25	

### GRADE 2 USS FLAT WASHER

PLAIN STEEL

Line: 104-00

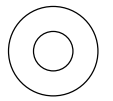

PART NUMBER	SIZE	QTY/BX	LIST PRICE
HLD03	3/16	100	
HLD04	1/4	100	
HLD05	5/16	100	
HLD06	3/8	100	
HLD07	7/16	100	
HLD08	1/2	100	
HLD09	9/16	50	
HLD10	5/8	50	
HLD12	3/4	50	
HLD14	7/8	25	
HLD16	1"	25	

(continued...)

**GRADE 2 USS FLAT WASHER (cont.)**

PLAIN STEEL

Line: 104-00

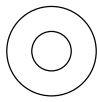

PART NUMBER	SIZE	QTY/BX	LIST PRICE
HLD18	1 1/8	25	
HLD20	1 1/4	25	
HLD22	1 3/8	25	
HLD24	1 1/2	25	
HLD26	1 5/8	25	
HLD28	1 3/4	25	
HLD30	1 7/8	25	
HLD32	2"	10	
HLD36	2 1/4	10	
HLD40	2 1/2	10	
HLD48	3"	10	

**GRADE 2 USS FLAT WASHER**

ZINC PLATED - 1 LB. AND 5 LB. BOXES

Line: 105-00

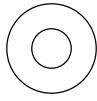

PART NUMBER	SIZE	QTY/BX	LIST PRICE
HMD03	3/16	5 lb.	
HMD03#1	3/16	1 lb.	
HMD04	1/4	5 lb.	
HMD04#1	1/4	1 lb.	
HMD05	5/16	5 lb.	
HMD05#1	5/16	1 lb.	
HMD06	3/8	5 lb.	
HMD06#1	3/8	1 lb.	
HMD07	7/16	5 lb.	
HMD07#1	7/16	1 lb.	
HMD08	1/2	5 lb.	
HMD08#1	1/2	1 lb.	
HMD09	9/16	5 lb.	
HMD09#1	9/16	1 lb.	
HMD10	5/8	5 lb.	
HMD10#1	5/8	1 lb.	
HMD12	3/4	5 lb.	
HMD12#1	3/4	1 lb.	
HMD14	7/8	5 lb.	
HMD14#1	7/8	1 lb.	
HMD16	1"	5 lb.	
HMD16#1	1"	1 lb.	
HMD18	1 1/8	5 lb.	
HMD20	1 1/4	5 lb.	
HMD22	1 3/8	5 lb.	
HMD24	1 1/2	5 lb.	
HMD26	1 5/8	5 lb.	
HMD28	1 3/4	5 lb.	
HMD32	2"	5 lb.	

(continued...)

**GRADE 2 USS FLAT WASHER (cont.)**

ZINC PLATED - 1 LB. AND 5 LB. BOXES

Line: 105-00

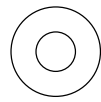

PART NUMBER	SIZE	QTY/BX	LIST PRICE
HMD36	2 1/4	5 lb.	
HMD40	2 1/2	5 lb.	
HMD48	3"	1 lb.	

**GRADE 2 SAE FLAT WASHER**

ZINC PLATED, MADE IN THE USA

Line: 107-00

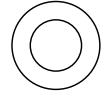

PART NUMBER	SIZE	QTY/BX	LIST PRICE
CBS022	#2	100	
CBS033	#3	100	
CBS044	#4	100	
CBS055	#5	100	
CBS066	#6	100	
CBS088	#8	100	
CBS03	#10	100	
CBS021	#12	100	
CBS04	1/4	100	
CBS05	5/16	100	
CBS06	3/8	100	
CBS07	7/16	100	
CBS08	1/2	100	
CBS09	9/16	50	
CBS10	5/8	50	
CBS12	3/4	50	
CBS14	7/8	25	
CBS16	1"	25	
CBS18	1 1/8	25	
CBS20	1 1/4	25	
CBS22	1 3/8	25	
CBS24	1 1/2	25	

**SAE FLAT WASHER**

PLAIN STEEL

Line: 108-00

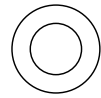

PART NUMBER	SIZE	QTY/BX	LIST PRICE
HND033	#3	100	
HND044	#4	100	
HND055	#5	100	
HND66	#6	100	
HND88	#8	100	
HND03	#10	100	
HND21	#12	100	
HND04	1/4	100	
HND05	5/16	100	
HND06	3/8	100	

(continued...)

## GRADE 2 SAE FLAT WASHER (cont.)

PLAIN STEEL

Line: 108-00

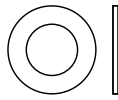

PART NUMBER	SIZE	QTY/BX	LIST PRICE
HND07	7/16	100	
HND08	1/2	100	
HND09	9/16	50	
HND10	5/8	50	
HND12	3/4	50	
HND14	7/8	25	
HND16	1"	25	
HND18	1 1/8	25	
HND20	1 1/4	25	
HND22	1 3/8	25	
HND24	1 1/2	25	

## GRADE 2 SAE FLAT WASHER

Zinc Plated

Line: 109-00

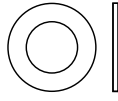

PART NUMBER	SIZE	QTY/BX	LIST PRICE
HPD022	#2	1 lb.	
HPD022MS	#2 (MACHINE SCREW WASH.)	1 lb.	
HPD44	#4	1 lb.	
HPD44MS	#4 (MACHINE SCREW WASH.)	1 lb.	
HPD55	#5	1 lb.	
HPD66	#6	1 lb.	
HPD66MS	#6 (MACHINE SCREW WASH.)	1 lb.	
HPD88	#8	1 lb.	
HPD88MS	#8 (MACHINE SCREW WASH.)	1 lb.	
HPD03	#10	1 lb.	
HPD03MS	#10 (MACHINE SCREW WASH.)	1 lb.	
HPD21	#12	1 lb.	
HPD21MS	#12 (MACHINE SCREW WASH.)	1 lb.	
HPD04	1/4	1 lb.	
HPD04MS	1/4 (MACHINE SCREW WASH.)	1 lb.	
HPD05	5/16	1 lb.	
HPD05MS	5/16 (MACHINE SCREW WASH.)	1 lb.	
HPD06	3/8	1 lb.	
HPD06MS	3/8 (MACHINE SCREW WASH.)	1 lb.	
HPD07	7/16	1 lb.	
HPD08	1/2	1 lb.	
HPD09	9/16	1 lb.	
HPD10	5/8	1 lb.	
HPD12	3/4	1 lb.	
HPD14	7/8	1 lb.	
HPD16	1	1 lb.	
HPD18	1 1/8	1 lb.	
HPD20	1 1/4	1 lb.	
HPD22	1 3/8	1 lb.	
HPD24	1 1/2	1 lb.	

## GRADE 2 FENDER WASHER

ZINC PLATED

Line: 110-00

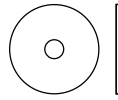

PART NUMBER	SIZE	QTY/BX	LIST PRICE
AZA0218	1/8 X 9/16	100	
AZA04018	1/4 X 9/16 (H6)	100	
AZA88024	#8 X 3/4	100	
AZA03024	3/16 X 3/4	100	
AZA03032	3/16 X 1	100	
AZA03040	3/16 X 1 1/4	100	
AZA02020	1/8 X 5/8	100	
AZA04032	1/4 X 1	100	
AZA04040	1/4 X 1 1/4	100	
AZA04048	1/4 X 1 1/2	100	
AZA04064	1/4 X 2	100	
AZAH04048	1/4 X 1 1/2 (HEXAGON PATTERN)	100	
AZA05040	5/16 X 1 1/4	100	
AZA05048	5/16 X 1 1/2	100	
AZA05048X	5/16 X 1 1/2 X (1/8 THICK)	100	
AZA06032	3/8 X 1	100	
AZA06040	3/8 X 1 1/4	100	
AZA06048	3/8 X 1 1/2	100	
AZAH06048	3/8 X 1 1/2 (HEXAGON PATTERN)	100	
AZA06052	3/8 X 1 5/8	100	
AZA06064	3/8 X 2	100	
AZA08048	1/2 X 1 1/2	50	
AZAH08048	1/2 X 1 1/2 (HEXAGON PATTERN)	50	
AZA08064	1/2 X 2	50	
AZA08064THK	1/2 X 2 X 1/8 (THICK)	50	
AZA08064THKG	1/2 X 2 X 1/8 (H.D.GALVANIZED)	50	

## GRADE 2 FENDER WASHER (THICK GAUGE)

ZINC PLATED

Line: 110-01

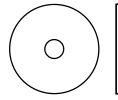

PART NUMBER	SIZE	QTY/BX	LIST PRICE
BYN03032	3/16 X 1"	100	
BYN03040	3/16 X 1 1/4	100	
BYN04032	1/4 X 1"	100	
BYN04040	1/4 X 1 1/4	100	
BYN04048	1/4 X 1 1/2	100	
BYN05040	5/16 X 1 1/4	100	
BYN05048	5/16 X 1 1/2	100	
BYN06040	3/8 X 1 1/4	100	
BYN06048	3/8 X 1 1/2	100	
BYN06052	3/8 X 1 5/8	100	
BYN08064	1/2 X 2"	50	



### USS HARDENED FLAT WASHER

ZINC YELLOW (ANSI B18.22.1, TYPE A, WIDE)

Line: 111-00

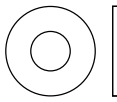

PART NUMBER	SIZE	QTY/BX	LIST PRICE
BBA03	3/16	100	
BBA04	1/4	100	
BBA05	5/16	100	
BBA06	3/8	100	
BBA07	7/16	100	
BBA08	1/2	100	
BBA09	9/16	50	
BBA10	5/8	50	
BBA12	3/4	50	
BBA14	7/8	25	
BBA16	1"	25	
BBA18	1 1/8	25	
BBA20	1 1/4	25	
BBA24	1 1/2	25	

### GRADE 8 USS FLAT WASHER

ZINC YELLOW HARDENED STEEL, EXTRA THICK GAUGE

Line: 111-01



PART NUMBER	SIZE	QTY/BX	LIST PRICE
BYP04	1/4 (.072)	100	
BYP05	5/16 (.086)	100	
BYP06	3/8 (.086)	100	
BYP07	7/16 (.098)	100	
BYP08	1/2 (.132)	100	
BYP09	9/16 (.132)	50	
BYP10	5/8 (.146)	50	
BYP12	3/4 (.146)	50	
BYP14	7/8 (.146)	25	
BYP16	1 (.146)	25	

### USS HARDENED FLAT WASHER

PLAIN STEEL (ANSI B18.22.1, TYPE A, WIDE)

Line: 111-05

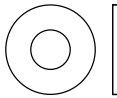

PART NUMBER	SIZE	QTY/BX	LIST PRICE
CDD04	1/4	100	
CDD05	5/16	100	
CDD06	3/8	100	
CDD07	7/16	100	
CDD08	1/2	100	
CDD09	9/16	50	
CDD10	5/8	50	
CDD12	3/4	50	
CDD14	7/8	25	
CDD16	1"	25	

### USS MEGA THICK FLAT WASHER

ZINC YELLOW HARDENED STEEL

Line: 111-10



PART NUMBER	SIZE	QTY/BX	LIST PRICE
FAT04	1/4 (.090/.110)	50	
FAT05	5/16 (.090/.110)	50	
FAT06	3/8 (.110/.126)	50	
FAT07	7/16 (.110/.126)	50	
FAT08	1/2 (.156/.188)	50	
FAT09	9/16 (.156/.188)	50	
FAT10	5/8 (.170/.195)	25	
FAT12	3/4 (.170/.195)	25	
FAT14	7/8 (.235/.265)	20	
FAT16	1 (.235/.265)	20	
FAT18	1 1/8 (.286/.336)	15	
FAT20	1 1/4 (.286/.336)	15	
FAT24	1 1/2 (.286/.336)	15	

### SAE MEGA THICK FLAT WASHER

ZINC YELLOW HARDENED STEEL

Line: 111-11



PART NUMBER	SIZE	QTY/BX	LIST PRICE
MEG04	1/4 (.090/.110)	50	
MEG05	5/16 (.090/.110)	50	
MEG06	3/8 (.110/.126)	50	
MEG07	7/16 (.110/.126)	50	
MEG08	1/2 (.156/.188)	50	
MEG09	9/16 (.156/.188)	50	
MEG10	5/8 (.170/.195)	25	
MEG12	3/4 (.170/.195)	25	
MEG14	7/8 (.235/.265)	25	
MEG16	1" (.235/.265)	25	
MEG18	1 1/8 (.286/.340)	20	
MEG20	1 1/4 (.286/.340)	20	
MEG24	1 1/2 (.286/.340)	15	

### A325 STRUCTURAL FLAT WASHER

PLAIN STEEL, F436/A325/A490

Line: 112-00

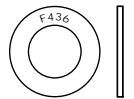

PART NUMBER	SIZE	QTY/BX	LIST PRICE
BAA04	1/4	100	
BAA05	5/16	100	
BAA06	3/8	100	
BAA07	7/16	100	
BAA08	1/2	100	
BAA09	9/16	50	
BAA10	5/8	50	
BAA12	3/4	50	
BAA14	7/8	25	
BAA16	1"	25	

(continued...)

### A325 STRUCTURAL FLAT WASHER

PLAIN STEEL, F436/A325/A490

Line: 112-00

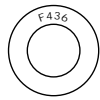

PART NUMBER	SIZE	QTY/BX	LIST PRICE
BAA18	1 1/8	25	
BAA20	1 1/4	25	
BAA22	1 3/8	25	
BAA24	1 1/2	25	
BAA28	1 3/4	25	
BAA32	2"	10	

### A325 STRUCTURAL FLAT WASHER

HOT DIP GALVANIZED, F436/A325/A490

Line: 112-01

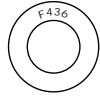

PART NUMBER	SIZE	QTY/BX	LIST PRICE
ASK08	1/2	100	
ASK10	5/8	50	
ASK12	3/4	50	
ASK14	7/8	25	
ASK16	1"	25	
ASK20	1 1/4	25	

### GRADE 8 SAE FLAT WASHER

ZINC YELLOW HARDENED STEEL, EXTRA THICK GAUGE

Line: 112-99

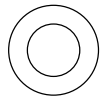

PART NUMBER	SIZE	QTY/BX	LIST PRICE
BYR04	1/4 (.072)	100	
BYR05	5/16 (.086)	100	
BYR06	3/8 (.086)	100	
BYR07	7/16 (.098)	100	
BYR08	1/2 (.132)	100	
BYR09	9/16 (.132)	50	
BYR10	5/8 (.146)	50	
BYR12	3/4 (.146)	50	
BYR14	7/8 (.146)	25	
BYR16	1" (.146)	25	

### GRADE 8 SAE FLAT WASHER

ZINC YELLOW (ANSI B18.22.1, TYPE A, NARROW)

Line: 113-00



PART NUMBER	SIZE	QTY/BX	LIST PRICE
HGD04	1/4	100	
HGD05	5/16	100	
HGD06	3/8	100	
HGD07	7/16	100	
HGD07Q50	7/16	50	
HGD08	1/2	100	
HGD08Q50	1/2	50	
HGD09	9/16	50	
HGD10	5/8	50	

(continued...)

### GRADE 8 SAE FLAT WASHER (cont.)

ZINC YELLOW (ANSI B18.22.1, TYPE A, NARROW)

Line: 113-00

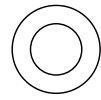

PART NUMBER	SIZE	QTY/BX	LIST PRICE
HGD12	3/4	50	
HGD14	7/8	25	
HGD16	1"	25	
HGD18	1 1/8	25	
HGD20	1 1/4	25	
HGD22	1 3/8	25	
HGD24	1 1/2	25	
HGD28	1 3/4	25	
HGD32	2"	10	

### GRADE 2 USS FLAT WASHER

HOT DIP GALVANIZED

Line: 113-02

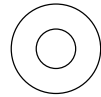

PART NUMBER	SIZE	QTY/BX	LIST PRICE
ANP04	1/4	100	
ANP04#5	1/4	5 lb.	
ANP05	5/16	100	
ANP05#5	5/16	5 lb.	
ANP06	3/8	100	
ANP06#5	3/8	5 lb.	
ANP06#50	3/8	50 lb.	
ANP07	7/16	100	
ANP08	1/2	100	
ANP08#5	1/2	5 lb.	
ANP08#50	1/2	50 lb.	
ANP10	5/8	50	
ANP10#5	5/8	5 lb.	
ANP10#50	5/8	50 lb.	
ANP12	3/4	50	
ANP12#5	3/4	5 lb.	
ANP12#50	3/4	50 lb.	
ANP14	7/8	25	
ANP14#5	7/8	5 lb.	
ANP16	1"	25	
ANP16#5	1"	5 lb.	
ANP16#50	1"	50 lb.	
ANP18	1 1/8	25	
ANP20	1 1/4	25	
ANP22	1 3/8	25	
ANP24	1 1/2	25	

**SQUARE PLATE WASHER**

HOT DIP GALVANIZED

Line: 113-03

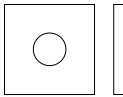

PART NUMBER	SIZE	QTY/BX	LIST PRICE
BMN08	1/2 X 2 (1/8)	25	
BMN10	5/8 X 2 (1/8)	25	
BMN10056096	5/8 X 1 3/4W X 3L (3/16)	25	
BMN10072	5/8 X 2 1/4 (3/16)	25	
BMN12	3/4 X 2 1/4 (3/16)	25	
BMN12096	3/4 X 3 (1/4)	25	
BMN14	7/8 X 3 (3/16)	25	
BMN16	1" X 3 1/2 (3/8)	10	

**REGULAR SPLIT LOCK WASHER**

ZINC PLATED - 100PCS./BOX

Line: 114-01



PART NUMBER	SIZE	QTY/BX	LIST PRICE
BCA66C	#6	100	
BCA88C	#8	100	
BCA03C	#10	100	
BCA21C	#12	100	
BCA04C	1/4	100	
BCA05C	5/16	100	
BCA06C	3/8	100	
BCA07C	7/16	100	
BCA08C	1/2	100	
BCA09C	9/16	100	
BCA10C	5/8	100	

**REGULAR SPLIT LOCK WASHER**

ZINC PLATED

Line: 114-00



PART NUMBER	SIZE	QTY/BX	LIST PRICE
BCA22	#2	500	
BCA33	#3	500	
BCA44	#4	500	
BCA55	#5	500	
BCA66	#6	500	
BCA88	#8	500	
BCA03	#10	500	
BCA21	#12	500	
BCA04	1/4	500	
BCA05	5/16	500	
BCA06	3/8	500	
BCA07	7/16	250	
BCA08	1/2	250	
BCA08HVV	1/2 (HEAVY PATTERN)	200	
BCA08Q50	1/2	50	
BCA09	9/16	200	
BCA10	5/8	200	
BCA10HVV	5/8 (HEAVY PATTERN)	100	
BCA12	3/4	100	
BCA12HVV	3/4 (HEAVY PATTERN)	100	
BCA14	7/8	50	
BCA14H	7/8 (HEAVY PATTERN)	50	
BCA14Q15	7/8	15	
BCA16	1"	50	
BCA16HVV	1" (HEAVY PATTERN)	50	
BCA18	1 1/8	25	
BCA20	1 1/4	25	
BCA20SPPK	1 1/4	100	
BCA23	1 3/8	25	
BCA24	1 1/2	25	
BCA28	1 3/4	10	
BCA32	2"	10	

**REGULAR SPLIT LOCK WASHER**

ZINC YELLOW, HIGH STRENGTH ALLOY STEEL

Line: 114-10

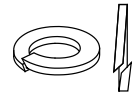

PART NUMBER	SIZE	QTY/BX	LIST PRICE
BXJ04	1/4	200	
BXJ04C	1/4	100	
BXJ05	5/16	200	
BXJ05C	5/16	100	
BXJ06	3/8	200	
BXJ06C	3/8	100	
BXJ07	7/16	100	
BXJ08	1/2	100	
BXJ09	9/16	100	
BXJ10	5/8	100	
BXJ10Q25	5/8	25	
BXJ12	3/4	50	
BXJ14	7/8	25	
BXJ16	1"	25	

**REGULAR SPLIT LOCK WASHER**

PLAIN STEEL

Line: 115-00



PART NUMBER	SIZE	QTY/BX	LIST PRICE
BDA22	#2	500	
BDA33	#3	500	
BDA44	#4	500	
BDA55	#5	500	
BDA66	#6	500	
BDA88	#8	500	
BDA03	#10	500	
BDA21	#12	500	
BDA04	1/4	500	
BDA04C	1/4	100	
BDA05	5/16	500	

(continued...)

## REGULAR SPLIT LOCK WASHER (cont.)

PLAIN STEEL

Line: 115-00

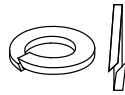

PART NUMBER	SIZE	QTY/BX	LIST PRICE
BDA05C	5/16	100	
BDA06	3/8	500	
BDA06C	3/8	100	
BDA07	7/16	250	
BDA07C	7/16	100	
BDA08	1/2	250	
BDA09	9/16	200	
BDA10	5/8	200	
BDA12	3/4	100	
BDA14	7/8	50	
BDA16	1"	50	
BDA18	1 1/8	25	
BDA20	1 1/4	25	
BDA23	1 3/8	25	
BDA24	1 1/2	25	
BDA28	1 3/4	10	
BDA32	2"	10	
BDA36	2 1/4	10	
BDA40	2 1/2	10	

## REGULAR SPLIT LOCK WASHER

HOT DIP GALVANIZED

Line: 115-01

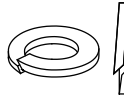

PART NUMBER	SIZE	QTY/BX	LIST PRICE
ANR04	1/4	100	
ANR05	5/16	100	
ANR06	3/8	100	
ANR07	7/16	100	
ANR08	1/2	100	
ANR10	5/8	50	
ANR12	3/4	50	
ANR14	7/8	25	
ANR16	1"	25	
ANR18	1 1/8	25	
ANR20	1 1/4	25	
ANR22	1 3/8	25	
ANR24	1 1/2	25	

## HI-COLLAR SPLIT LOCK WASHER

PLAIN STEEL

Line: 116-00



PART NUMBER	SIZE	QTY/BX	LIST PRICE
BEA66	#6	100	
BEA88	#8	100	
BEA03	#10	100	
BEA21X	#12	100	
BEA04	1/4	100	
BEA05	5/16	100	
BEA06	3/8	100	
BEA07	7/16	100	
BEA08	1/2	100	
BEA09X	9/16	100	
BEA10	5/8	50	
BEA12	3/4	50	
BEA14	7/8	50	
BEA16	1"	50	
BEA18	1 1/8	50	
BEA20X	1 1/4	25	
BEA24X	1 1/2	25	

## HI-COLLAR SPLIT LOCK WASHER

ZINC PLATED

Line: 117-00



PART NUMBER	SIZE	QTY/BX	LIST PRICE
DXD55X	#5	100	
DXD66	#6	100	
DXD88	#8	100	
DXD03	#10	100	
DXD21X	#12	100	
DXD04	1/4	100	
DXD05	5/16	100	
DXD06	3/8	100	
DXD07	7/16	100	
DXD08	1/2	100	
DXD09X	9/16	100	
DXD10	5/8	50	
DXD12	3/4	50	
DXD14	7/8	50	
DXD16	1"	50	
DXD18	1 1/8	50	

### LOCK SET WASHER - PAIRS

ZINC DICHROMATE

Line: 117-01

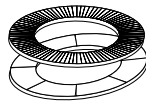

PART NUMBER	SIZE	QTY/BX	LIST PRICE
ATM66	#6	100 pr	
ATM88	#8	100 pr	
ATM03	#10	100 pr	
ATM04	1/4	50 pair	
ATM05	5/16	50 pair	
ATM06	3/8	50 pair	
ATM07	7/16	50 pair	
ATM08	1/2	50 pair	
ATM09	9/16	25 pair	
ATM10	5/8	25 pair	
ATM12	3/4	25 pair	
ATM14	7/8	25 pair	
ATM16	1"	25 pair	
ATM18	1 1/8	10 pair	
ATM20	1 1/4	10 pair	
ATM22	1 3/8	10 pair	
ATM24	1 1/2	10 pair	

### EXTERNAL TOOTH LOCKWASHER

ZINC PLATED

Line: 119-00

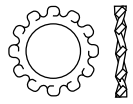

PART NUMBER	SIZE	QTY/BX	LIST PRICE
BGA22	#2	100	
BGA33	#3	100	
BGA44	#4	100	
BGA55	#5	100	
BGA66	#6	100	
BGA88	#8	100	
BGA03	#10	100	
BGA21	#12	100	
BGA04	1/4	100	
BGA05	5/16	100	
BGA06	3/8	100	
BGA07	7/16	100	
BGA08	1/2	100	
BGA09	9/16	50	
BGA10	5/8	50	
BGA12	3/4	50	
BGA14	7/8	50	
BGA16	1"	25	

### INTERNAL TOOTH LOCKWASHER

ZINC PLATED

Line: 118-00



PART NUMBER	SIZE	QTY/BX	LIST PRICE
BFA22	#2	100	
BFA33	#3	100	
BFA44	#4	100	
BFA55	#5	100	
BFA66	#6	100	
BFA88	#8	100	
BFA03	#10	100	
BFA21	#12	100	
BFA04	1/4	100	
BFA05	5/16	100	
BFA06	3/8	100	
BFA07	7/16	100	
BFA08	1/2	100	
BFA09	9/16	50	
BFA10	5/8	50	
BFA12	3/4	50	
BFA14	7/8	50	
BFA16	1"	25	
BFA18	1 1/8	25	
BFA20	1 1/4	25	

### INT./EXT. TOOTH LOCKWASHER

ZINC PLATED

Line: 120-00



PART NUMBER	SIZE	QTY/BX	LIST PRICE
BHA44	#4	100	
BHA66	#6	100	
BHA88	#8	100	
BHA03	#10	100	
BHA21	#12	100	
BHA04	1/4	100	
BHA05	5/16	100	
BHA06	3/8	100	
BHA07	7/16	100	
BHA08	1/2	100	
BHA10	5/8	50	
BHA12	3/4	50	



**CALL - 1 (800) 723-2826**

## EXTERNAL TOOTH LOCKWASHER

COUNTERSUNK - ZINC PLATED

Line: 121-00

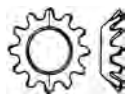

PART NUMBER	SIZE	QTY/BX	LIST PRICE
BJA66	#6	100	
BJA88	#8	100	
BJA03	#10	100	
BJA21	#12	100	
BJA05	5/16	100	
BJA04	1/4	100	
BJA06	3/8	100	
BJA08	1/2	100	

## HARDENED BEVEL WASHER

F436/A325/A490

Line: 124-00



PART NUMBER	SIZE	QTY/BX	LIST PRICE
CJA08	1/2	25	
CJA10	5/8	25	
CJA12	3/4	25	
CJA14	7/8	25	
CJA16	1"	25	

## MALLEABLE BEVEL WASHER

PLAIN FINISH

Line: 125-00



PART NUMBER	SIZE	QTY/BX	LIST PRICE
CKA04	1/4	25	
CKA05	5/16	25	
CKA06	3/8	25	
CKA08	1/2	25	
CKA10	5/8	25	
CKA12	3/4	25	
CKA14	7/8	25	
CKA16	1"	25	
CKA18	1 1/8	25	
CKA20	1 1/4	25	
CKA24X	1 1/2	25	

## MALLEABLE BEVEL WASHER

HOT DIP GALVANIZED

Line: 126-00



PART NUMBER	SIZE	QTY/BX	LIST PRICE
CLA04	1/4	25	
CLA05	5/16	25	
CLA06	3/8	25	
CLA08	1/2	25	
CLA10	5/8	25	
CLA12	3/4	25	

(continued...)

## MALLEABLE BEVEL WASHER (cont.)

HOT DIP GALVANIZED

Line: 126-00



PART NUMBER	SIZE	QTY/BX	LIST PRICE
CLA14	7/8	25	
CLA16	1"	25	
CLA18	1 1/8	25	
CLA20	1 1/4	25	

## REGULAR MACHINERY BUSHING

18 GA - PLAIN FINISH

Line: 129-00

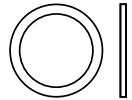

PART NUMBER	SIZE	QTY/BX	LIST PRICE
BZA14008	7/8 X 1/2	100	
BZA15009	15/16 X 9/16	100	
BZA16010	1 X 5/8	100	
BZA20012	1 1/4 X 3/4	50	
BZA22014	1 3/8 X 7/8	50	
BZA24016	1 1/2 X 1	50	
BZA28018	1 3/4 X 1 1/8	50	
BZA30020	1 7/8 X 1 1/4	50	
BZA34022	2 1/8 X 1 3/8	25	
BZA36024	2 1/4 X 1 1/2	25	
BZA40028	2 1/2 X 1 3/4	25	
BZA68048X	3 X 4 1/4	25	

## REGULAR MACHINERY BUSHING

14 GA - PLAIN FINISH

Line: 130-00

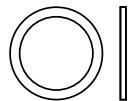

PART NUMBER	SIZE	QTY/BX	LIST PRICE
CAA14008	7/8 X 1/2	100	
CAA15009	15/16 X 9/16	100	
CAA16010	1 X 5/8	50	
CAA20012	1 1/4 X 3/4	50	
CAA22014	1 3/8 X 7/8	50	
CAA24016	1 1/2 X 1	50	
CAA28018	1 3/4 X 1 1/8	50	
CAA30020	1 7/8 X 1 1/4	25	
CAA34022	2 1/8 X 1 3/8	25	
CAA36024	2 1/4 X 1 1/2	25	
CAA38026	2 3/8 X 1 5/8	25	
CAA40028	2 1/2 X 1 3/4	25	
CAA46030	2 7/8 X 1 7/8	25	
CAA48032	3 X 2	25	
CAA50034	3 1/8 X 2 1/8	25	
CAA52036	3 1/4 X 2 1/4	25	
CAA54038	3 3/8 X 2 3/8	25	
CAA56040	3 1/2 X 2 1/2	25	

### REGULAR MACHINERY BUSHING

10 GA - PLAIN FINISH

Line: 131-00

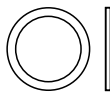

PART NUMBER	SIZE	QTY/BX	LIST PRICE
CBA20012	1 1/4 X 3/4	50	
CBA22014	1 3/8 X 7/8	50	
CBA24016	1 1/2 X 1	50	
CBA28018	1 3/4 X 1 1/8	50	
CBA30020	1 7/8 X 1 1/4	50	
CBA34022	2 1/8 X 1 3/8	25	
CBA36024	2 1/4 X 1 1/2	25	
CBA38026	2 3/8 X 1 5/8	25	
CBA40028	2 1/2 X 1 3/4	25	
CBA46030	2 7/8 X 1 7/8	25	
CBA48032	3 X 2	25	
CBA50034	3 1/8 X 2 1/8	25	
CBA52036	3 1/4 X 2 1/4	25	
CBA54038	3 3/8 X 2 3/8	25	
CBA56040	3 1/2 X 2 1/2	25	

### REGULAR MACHINERY BUSHING

3/16 THICK - PLAIN FINISH

Line: 132-00

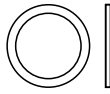

PART NUMBER	SIZE	QTY/BX	LIST PRICE
CCA56040	3 1/2 X 2 1/2	25	

### WIDE MACHINERY BUSHING

18 GA - PLAIN FINISH

Line: 133-00

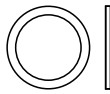

PART NUMBER	SIZE	QTY/BX	LIST PRICE
CDA20010	1 1/4 X 5/8	50	
CDA24012	1 1/2 X 3/4	50	
CDA32016	2 X 1	25	
CDA36020	2 1/4 X 1 1/4	25	
CDA52028	3 1/4 X 1 3/4	25	
CDA56032	3 1/2 X 2	25	
CDA60036	3 3/4 X 2 1/4	25	
CDA62040	3 7/8 X 2 1/2	25	
CDA64044	4 X 2 3/4	10	

### WIDE MACHINERY BUSHING

14 GA - PLAIN FINISH

Line: 134-00

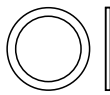

PART NUMBER	SIZE	QTY/BX	LIST PRICE
CEA20010	1 1/4 X 5/8	50	
CEA24012	1 1/2 X 3/4	50	
CEA28014	1 3/4 X 7/8	50	
CEA30015	1 7/8 X 15/16	50	
CEA32016	2 X 1	25	
CEA33017	2 1/16 X 1 1/16	25	

(continued...)

### WIDE MACHINERY BUSHING (cont.)

14 GA - PLAIN FINISH

Line: 134-00

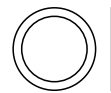

PART NUMBER	SIZE	QTY/BX	LIST PRICE
CEA34018	2 1/8 X 1 1/8	25	
CEA36020	2 1/4 X 1 1/4	25	
CEA40022	2 1/2 X 1 3/8	25	
CEA48024	3 X 1 1/2	25	
CEA52028	3 1/4 X 1 3/4	25	
CEA56032	3 1/2 X 2	25	
CEA62040	3 7/8 X 2 1/2	25	
CEA64044	4 X 2 3/4	10	

### WIDE MACHINERY BUSHING

10 GA - PLAIN FINISH

Line: 135-00

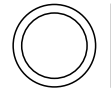

PART NUMBER	SIZE	QTY/BX	LIST PRICE
CFA24012	1 1/2 X 3/4	50	
CFA32016	2 X 1	25	
CFA34018	2 1/8 X 1 1/8	25	
CFA40022	2 1/2 X 1 3/8	25	
CFA48024	3 X 1 1/2	25	
CFA50026	3 1/8 X 1 5/8	25	
CFA52028	3 1/4 X 1 3/4	25	
CFA54030	3 3/8 X 1 7/8	25	
CFA56032	3 1/2 X 2	25	
CFA62040	3 7/8 X 2 1/2	25	
CFA64044	4 X 2 3/4	10	
CFA68048	4 1/4 X 3	10	

### COUNTERSUNK FINISHING WASHER

NICKEL PLATED BRASS

Line: 136-00

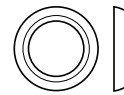

PART NUMBER	SIZE	QTY/BX	LIST PRICE
DKD44	#4	100	
DKD66	#6	100	
DKD88	#8	100	
DKD88BRS	#8 (BRASS ONLY)	100	
DKD03	#10	100	
DKD21	#12	100	
DKD04	1/4	100	
DKD04BRS	1/4 (BRASS ONLY)	100	
DKD05	5/16	100	

## COUNTERSUNK FINISHING WASHER

NICKEL PLATED STEEL

Line: 136-05



PART NUMBER	SIZE	QTY/BX	LIST PRICE
APH66	#6	100	
APH88	#8	100	
APH03	#10	100	
APH21	#12	100	
APH04	1/4	100	
APH05	5/16	100	

## COUNTERSUNK FINISHING WASHER

ZINC PLATED STEEL

Line: 136-06



PART NUMBER	SIZE	QTY/BX	LIST PRICE
CGS66	#6	100	
CGS88	#8	100	
CGS03	#10	100	
CGS21	#12	100	
CGS04	#14	100	

## T-SLOT THICK BOTTOM WASHER

HEAT TREATED - BLACK FINISH

Line: 137-00

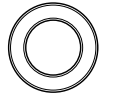

PART NUMBER	SIZE	QTY/BX	LIST PRICE
JGD04	1/4 X 5/8 X 1/8	50	
JGD05	5/16 X 3/4 X 1/8	50	
JGD06	3/8 X 7/8 X 1/8	50	
JGD08	1/2 X 1 X 3/16	25	
JGD10	5/8 X 1 1/4 X 1/4	25	
JGD12	3/4 X 1 1/2 X 1/4	25	
JGD14	7/8 X 1 3/4 X 1/4	25	
JGD16	1 X 2 X 5/16	25	
JGD18	1 1/8 X 2 1/4 X 5/16	10	
JGD20	1 1/4 X 2 1/4 X 5/16	10	



CALL - 1 (800) 723-2826



# SECTION 3 PRODUCT INDEX



Line Description	Alpha	Line#	Page#
HEX BOLTS GRADE 2 - PLAIN FINISH - UNC	<b>ABU</b>	<b>138-00</b>	3-2
HEX BOLTS GRADE 2 - ZINC PLATED - UNC	<b>ACU</b>	<b>139-00</b>	3-4
HEX BOLTS - GRADE 2 - HOT DIP GALVANIZED - UNC	<b>JEP</b>	<b>139-05</b>	3-7
HEX TAP BOLTS - GRADE 2 - FULL THREAD ZINC - UNC	<b>DNC</b>	<b>140-00</b>	3-9
HEX CAP SCREW - GRADE 5 - FULL THREAD ZINC - UNC	<b>BML</b>	<b>140-01</b>	3-10
HEX CAP SCREW - DOMESTIC GRADE 5 - FULL THREAD ZINC - UNC	<b>JJC</b>	<b>140-99</b>	3-11
HEX CAP SCREW - DOMESTIC GRADE 5 - ZINC - UNC	<b>AEU</b>	<b>143-00</b>	3-12
HEX CAP SCREW - DOMESTIC GRADE 5 - ZINC - UNF	<b>AES</b>	<b>144-00</b>	3-15
HEX CAP SCREW - DOMESTIC GRADE 8 - YELLOW/ZINC - UNC	<b>DAD</b>	<b>147-00</b>	3-18
HEX CAP SCREW - DOMESTIC GRADE 8 - YELLOW/ZINC - UNF	<b>DBD</b>	<b>148-00</b>	3-21
HEX CAP SCREW - NO. AMERICAN GRADE 5 - ZINC - UNC	<b>JJM</b>	<b>148-01</b>	3-24
HEX CAP SCREW - NO. AMERICAN GRADE 5 - PLAIN - UNC	<b>JJN</b>	<b>148-02</b>	3-28
HEX CAP SCREW - NO. AMERICAN GRADE 5 - ZINC - UNF	<b>JTR</b>	<b>148-03</b>	3-30
HEX CAP SCREW - NO. AMERICAN GRADE 8 - YELLOW/ZINC - UNC	<b>JKR</b>	<b>148-05</b>	3-33
HEX CAP SCREW - NO. AMERICAN GRADE 8 - YELLOW/ZINC - UNF	<b>JAS</b>	<b>148-07</b>	3-36
T9 HEX CAP SCREW 180K PSI HI-HEAD - YELLOW/ZINC - UNC	<b>ACD</b>	<b>148-09</b>	3-38
T9 HEX CAP SCREW 180K PSI HI-HEAD - YELLOW/ZINC - UNF	<b>ACE</b>	<b>148-10</b>	3-40
HEX MACHINE BOLTS - GRADE 2 - PLAIN FINISH - UNC	<b>CRA</b>	<b>149-00</b>	3-42
<b>SPECIAL ORDER BOLTS</b>			
HEX BOLT - HOT FORGE - GRADE 5 - PLAIN	<b>DEA</b>	<b>150-00</b>	3-43
HEX BOLT - HOT FORGE - GRADE 8 - PLAIN	<b>DFA</b>	<b>151-00</b>	3-44
A325 STRUCTURAL BOLTS W/NUTS - PLAIN	<b>DJA</b>	<b>152-00</b>	3-44
A325 STRUCTURAL BOLTS NO/NUTS - PLAIN	<b>DLA</b>	<b>153-00</b>	3-46
A325 STRUCTURAL BOLTS NO/NUTS - HOT DIP GALVANIZED	<b>BBT</b>	<b>153-01</b>	3-46
A490 STRUCTURAL BOLTS W/NUTS - PLAIN STEEL - UNC	<b>DKA</b>	<b>154-00</b>	3-47
HEX BOLTS - GRADE B7 - PLAIN FINISH	<b>JBG</b>	<b>154-01</b>	3-47



**CALL - 1 (800) 723-2826**

## GRADE 2 HEX MACHINE BOLT

PLAIN STEEL, UNC

Line: 138-00

FOR LARGER & LONGER SIZES  
ALSO CHECK LINE: 149-00

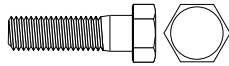

## GRADE 2 HEX MACHINE BOLT (cont.)

PLAIN STEEL, UNC

Line: 138-00

FOR LARGER & LONGER SIZES  
ALSO CHECK LINE: 149-00

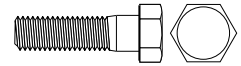

PAGE 3-2

CAP SCREWS - SECTION 03

PART NUMBER	SIZE	QTY/BX	LIST PRICE
ABU04012	1/4-20 x 3/8	100	
ABU04016	1/4-20 x 1/2	100	
ABU04020	1/4-20 x 5/8	100	
ABU04024	1/4-20 x 3/4	100	
ABU04028	1/4-20 x 7/8	100	
ABU04032	1/4-20 x 1	100	
ABU04040	1/4-20 x 1 1/4	100	
ABU04048	1/4-20 x 1 1/2	100	
ABU04056	1/4-20 x 1 3/4	100	
ABU04064	1/4-20 x 2	100	
ABU04072	1/4-20 x 2 1/4	50	
ABU04080	1/4-20 x 2 1/2	50	
ABU04088	1/4-20 x 2 3/4	50	
ABU04096	1/4-20 x 3	50	
ABU04104	1/4-20 x 3 1/4	50	
ABU04112	1/4-20 x 3 1/2	50	
ABU04120	1/4-20 x 3 3/4	50	
ABU04128	1/4-20 x 4	50	
ABU04144	1/4-20 x 4 1/2	50	
ABU04160	1/4-20 x 5	50	
ABU04176	1/4-20 x 5 1/2	50	
ABU04192	1/4-20 x 6	50	
ABU04208	1/4-20 x 6 1/2	50	
ABU04224	1/4-20 x 7	50	
ABU04240	1/4-20 x 7 1/2	50	
ABU04256	1/4-20 x 8	50	
ABU05016	5/16-18 x 1/2	100	
ABU05020	5/16-18 x 5/8	100	
ABU05024	5/16-18 x 3/4	100	
ABU05028	5/16-18 x 7/8	100	
ABU05032	5/16-18 x 1	100	
ABU05040	5/16-18 x 1 1/4	100	
ABU05048	5/16-18 x 1 1/2	100	
ABU05056	5/16-18 x 1 3/4	100	
ABU05064	5/16-18 x 2	100	
ABU05072	5/16-18 x 2 1/4	50	
ABU05080	5/16-18 x 2 1/2	50	
ABU05088	5/16-18 x 2 3/4	50	
ABU05096	5/16-18 x 3	50	
ABU05104	5/16-18 x 3 1/4	50	
ABU05112	5/16-18 x 3 1/2	50	
ABU05120X	5/16-18 x 3 3/4	1	
ABU05128	5/16-18 x 4	25	
ABU05144	5/16-18 x 4 1/2	25	

(continued...)

PART NUMBER	SIZE	QTY/BX	LIST PRICE
ABU05160	5/16-18 x 5	25	
ABU05176	5/16-18 x 5 1/2	25	
ABU05192	5/16-18 x 6	25	
ABU05208	5/16-18 x 6 1/2	25	
ABU05224	5/16-18 x 7	25	
ABU05240	5/16-18 x 7 1/2	25	
ABU05256	5/16-18 x 8	25	
ABU06016	3/8-16 x 1/2	100	
ABU06020	3/8-16 x 5/8	100	
ABU06024	3/8-16 x 3/4	100	
ABU06028	3/8-16 x 7/8	100	
ABU06032	3/8-16 x 1	100	
ABU06040	3/8-16 x 1 1/4	100	
ABU06048	3/8-16 x 1 1/2	100	
ABU06056	3/8-16 x 1 3/4	50	
ABU06064	3/8-16 x 2	50	
ABU06072	3/8-16 x 2 1/4	50	
ABU06080	3/8-16 x 2 1/2	50	
ABU06088	3/8-16 x 2 3/4	50	
ABU06096	3/8-16 x 3	50	
ABU06104	3/8-16 x 3 1/4	50	
ABU06112	3/8-16 x 3 1/2	50	
ABU06120	3/8-16 x 3 3/4	50	
ABU06128	3/8-16 x 4	25	
ABU06144	3/8-16 x 4 1/2	25	
ABU06160	3/8-16 x 5	25	
ABU06176	3/8-16 x 5 1/2	25	
ABU06192	3/8-16 x 6	25	
ABU06208	3/8-16 x 6 1/2	25	
ABU06224	3/8-16 x 7	25	
ABU06240	3/8-16 x 7 1/2	25	
ABU06256	3/8-16 x 8	25	
ABU07024	7/16-14 x 3/4	50	
ABU07028X	7/16-14 x 7/8	50	
ABU07032	7/16-14 x 1	50	
ABU07040	7/16-14 x 1 1/4	50	
ABU07048	7/16-14 x 1 1/2	50	
ABU07056	7/16-14 x 1 3/4	50	
ABU07064	7/16-14 x 2	50	
ABU07072	7/16-14 x 2 1/4	25	
ABU07080	7/16-14 x 2 1/2	25	
ABU07088	7/16-14 x 2 3/4	25	
ABU07096	7/16-14 x 3	25	
ABU07112	7/16-14 x 3 1/2	25	

(continued...)

**GRADE 2 HEX MACHINE BOLT (cont.)**

PLAIN STEEL, UNC

FOR LARGER & LONGER SIZES  
ALSO CHECK LINE: 149-00

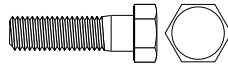

Line: 138-00

PART NUMBER	SIZE	QTY/BX	LIST PRICE
ABU07128	7/16-14 x 4	25	
ABU07144	7/16-14 x 4 1/2	25	
ABU07160	7/16-14 x 5	25	
ABU07176	7/16-14 x 5 1/2	25	
ABU07192	7/16-14 x 6	25	
ABU08024	1/2-13 x 3/4	50	
ABU08028	1/2-13 x 7/8	50	
ABU08032	1/2-13 x 1	50	
ABU08040	1/2-13 x 1 1/4	50	
ABU08048	1/2-13 x 1 1/2	50	
ABU08056	1/2-13 x 1 3/4	50	
ABU08064	1/2-13 x 2	50	
ABU08072	1/2-13 x 2 1/4	25	
ABU08080	1/2-13 x 2 1/2	25	
ABU08088	1/2-13 x 2 3/4	25	
ABU08096	1/2-13 x 3	25	
ABU08104	1/2-13 x 3 1/4	25	
ABU08112	1/2-13 x 3 1/2	25	
ABU08120	1/2-13 x 3 3/4	25	
ABU08128	1/2-13 x 4	25	
ABU08144	1/2-13 x 4 1/2	25	
ABU08160	1/2-13 x 5	25	
ABU08176	1/2-13 x 5 1/2	25	
ABU08192	1/2-13 x 6	25	
ABU08208	1/2-13 x 6 1/2	25	
ABU08224	1/2-13 x 7	25	
ABU08240	1/2-13 x 7 1/2	25	
ABU08256	1/2-13 x 8	25	
ABU10032	5/8-11 x 1	50	
ABU10040	5/8-11 x 1 1/4	25	
ABU10048	5/8-11 x 1 1/2	25	
ABU10056	5/8-11 x 1 3/4	25	
ABU10064	5/8-11 x 2	25	
ABU10072	5/8-11 x 2 1/4	25	
ABU10080	5/8-11 x 2 1/2	25	
ABU10088	5/8-11 x 2 3/4	25	
ABU10096	5/8-11 x 3	25	
ABU10104	5/8-11 x 3 1/4	25	
ABU10112	5/8-11 x 3 1/2	25	
ABU10120	5/8-11 x 3 3/4	25	
ABU10128	5/8-11 x 4	25	
ABU10144	5/8-11 x 4 1/2	25	
ABU10160	5/8-11 x 5	25	
ABU10176	5/8-11 x 5 1/2	25	

(continued...)

**GRADE 2 HEX MACHINE BOLT (cont.)**

PLAIN STEEL, UNC

FOR LARGER & LONGER SIZES  
ALSO CHECK LINE: 149-00

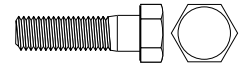

Line: 138-00

PART NUMBER	SIZE	QTY/BX	LIST PRICE
ABU10192	5/8-11 x 6	25	
ABU10208	5/8-11 x 6 1/2	25	
ABU10224	5/8-11 x 7	25	
ABU10240	5/8-11 x 7 1/2	25	
ABU10256	5/8-11 x 8	25	
ABU12040	3/4-10 x 1 1/4	25	
ABU12048	3/4-10 x 1 1/2	25	
ABU12056	3/4-10 x 1 3/4	25	
ABU12064	3/4-10 x 2	25	
ABU12072	3/4-10 x 2 1/4	25	
ABU12080	3/4-10 x 2 1/2	25	
ABU12088	3/4-10 x 2 3/4	25	
ABU12096	3/4-10 x 3	25	
ABU12104	3/4-10 x 3 1/4	25	
ABU12112	3/4-10 x 3 1/2	25	
ABU12120	3/4-10 x 3 3/4	25	
ABU12128	3/4-10 x 4	25	
ABU12144	3/4-10 x 4 1/2	10	
ABU12160	3/4-10 x 5	10	
ABU12176	3/4-10 x 5 1/2	10	
ABU12192	3/4-10 x 6	10	
ABU12208	3/4-10 x 6 1/2	10	
ABU12224	3/4-10 x 7	10	
ABU12240	3/4-10 x 7 1/2	10	
ABU12256	3/4-10 x 8	10	
ABU12320	3/4-10 x 10	1	
ABU14048	7/8-9 x 1 1/2	15	
ABU14056	7/8-9 x 1 3/4	15	
ABU14064	7/8-9 x 2	15	
ABU14072	7/8-9 x 2 1/4	15	
ABU14080	7/8-9 x 2 1/2	15	
ABU14088	7/8-9 x 2 3/4	15	
ABU14096	7/8-9 x 3	15	
ABU14104	7/8-9 x 3 1/4	15	
ABU14112	7/8-9 x 3 1/2	15	
ABU14128	7/8-9 x 4	10	
ABU14144	7/8-9 x 4 1/2	10	
ABU14160	7/8-9 x 5	10	
ABU14176	7/8-9 x 5 1/2	10	
ABU14192	7/8-9 x 6	10	
ABU14208	7/8-9 x 6 1/2	10	
ABU14224	7/8-9 x 7	10	
ABU14240	7/8-9 x 7 1/2	10	
ABU14256	7/8-9 x 8	10	

(continued...)

**GRADE 2 HEX MACHINE BOLT (cont.)**

PLAIN STEEL, UNC

Line: 138-00

FOR LARGER & LONGER SIZES  
ALSO CHECK LINE: 149-00

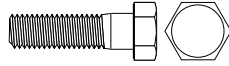

PART NUMBER	SIZE	QTY/BX	LIST PRICE
ABU16064	1-8 x 2	10	
ABU16072	1-8 x 2 1/4	10	
ABU16080	1-8 x 2 1/2	10	
ABU16088	1-8 x 2 3/4	10	
ABU16096	1-8 x 3	10	
ABU16104	1-8 x 3 1/4	10	
ABU16112	1-8 x 3 1/2	10	
ABU16128	1-8 x 4	10	
ABU16144	1-8 x 4 1/2	10	
ABU16160	1-8 x 5	10	
ABU16176	1-8 x 5 1/2	10	
ABU16192	1-8 x 6	10	
ABU16208	1-8 x 6 1/2	5	
ABU16224	1-8 x 7	5	
ABU16240	1-8 x 7 1/2	5	
ABU16256	1-8 x 8	5	
ABU18096	1 1/8-7 x 3	5	
ABU18112	1 1/8-7 x 3 1/2	5	
ABU18128	1 1/8-7 x 4	5	
ABU18144	1 1/8-7 x 4 1/2	5	
ABU18160	1 1/8-7 x 5	5	
ABU18176	1 1/8-7 x 5 1/2	5	
ABU18192	1 1/8-7 x 6	5	
ABU18208	1 1/8-7 x 6 1/2	5	
ABU18224	1 1/8-7 x 7	5	
ABU18256	1 1/8-7 x 8	5	
ABU18288	1 1/8-7 x 9	1	
ABU18320	1 1/8-7 x 10	1	
ABU18352	1 1/8-7 x 11	1	
ABU18384	1 1/8-7 x 12	1	
ABU20080	1 1/4-7 x 2 1/2	5	
ABU20096	1 1/4-7 x 3	5	
ABU20112	1 1/4-7 x 3 1/2	5	
ABU20128	1 1/4-7 x 4	5	
ABU20144	1 1/4-7 x 4 1/2	5	
ABU20160	1 1/4-7 x 5	5	
ABU20176	1 1/4-7 x 5 1/2	5	
ABU20192	1 1/4-7 x 6	5	
ABU20208	1 1/4-7 x 6 1/2	5	
ABU20224	1 1/4-7 x 7	5	
ABU20240	1 1/4-7 x 7 1/2	5	
ABU20256	1 1/4-7 x 8	5	
ABU20288	1 1/4-7 x 9	1	
ABU20320	1 1/4-7 x 10	1	

(continued...)

**GRADE 2 HEX MACHINE BOLT (cont.)**

PLAIN STEEL, UNC

Line: 138-00

FOR LARGER & LONGER SIZES  
ALSO CHECK LINE: 149-00

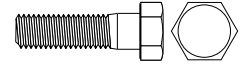

PART NUMBER	SIZE	QTY/BX	LIST PRICE
ABU20384	1 1/4-7 x 12	1	
ABU24128	1 1/2-6 x 4	1	
ABU24144	1 1/2-6 x 4 1/2	5	
ABU24160	1 1/2-6 x 5	1	
ABU24176	1 1/2-6 x 5 1/2	1	
ABU24192	1 1/2-6 x 6	1	
ABU24208	1 1/2-6 x 6 1/2	1	
ABU24224	1 1/2-6 x 7	1	
ABU24240	1 1/2-6 x 7 1/2	1	
ABU24256	1 1/2-6 x 8	1	
ABU24320	1 1/2-6 x 10	1	
ABU24384	1 1/2-6 x 12	1	

**GRADE 2 HEX MACHINE BOLT**

ZINC PLATED, UNC

Line: 139-00

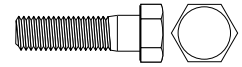

PART NUMBER	SIZE	QTY/BX	LIST PRICE
ACU04012	1/4-20 x 3/8	100	
ACU04016	1/4-20 x 1/2	100	
ACU04020	1/4-20 x 5/8	100	
ACU04024	1/4-20 x 3/4	100	
ACU04028	1/4-20 x 7/8	100	
ACU04032	1/4-20 x 1	100	
ACU04040	1/4-20 x 1 1/4	100	
ACU04048	1/4-20 x 1 1/2	100	
ACU04056	1/4-20 x 1 3/4	100	
ACU04064	1/4-20 x 2	100	
ACU04072	1/4-20 x 2 1/4	50	
ACU04080	1/4-20 x 2 1/2	50	
ACU04088	1/4-20 x 2 3/4	50	
ACU04096	1/4-20 x 3	50	
ACU04104	1/4-20 x 3 1/4	50	
ACU04112	1/4-20 x 3 1/2	50	
ACU04120	1/4-20 x 3 3/4	50	
ACU04128	1/4-20 x 4	50	
ACU04144	1/4-20 x 4 1/2	50	
ACU04160	1/4-20 x 5	50	
ACU04176	1/4-20 x 5 1/2	50	
ACU04192	1/4-20 x 6	50	
ACU04208	1/4-20 x 6 1/2	50	
ACU04224	1/4-20 x 7	50	
ACU04240	1/4-20 x 7 1/2	50	
ACU04256	1/4-20 x 8	50	
ACU05016	5/16-18 x 1/2	100	
ACU05020	5/16-18 x 5/8	100	

(continued...)

**GRADE 2 HEX MACHINE BOLT (cont.)**

ZINC PLATED, UNC

Line: 139-00

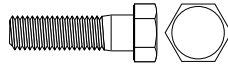

PART NUMBER	SIZE	QTY/BX	LIST PRICE
ACU05024	5/16-18 x 3/4	100	
ACU05028	5/16-18 x 7/8	100	
ACU05032	5/16-18 x 1	100	
ACU05040	5/16-18 x 1 1/4	100	
ACU05048	5/16-18 x 1 1/2	100	
ACU05056	5/16-18 x 1 3/4	100	
ACU05064	5/16-18 x 2	100	
ACU05072	5/16-18 x 2 1/4	50	
ACU05080	5/16-18 x 2 1/2	50	
ACU05088	5/16-18 x 2 3/4	50	
ACU05096	5/16-18 x 3	50	
ACU05104	5/16-18 x 3 1/4	50	
ACU05112	5/16-18 x 3 1/2	50	
ACU05120X	5/16-18 x 3 3/4	50	
ACU05128	5/16-18 x 4	50	
ACU05144	5/16-18 x 4 1/2	25	
ACU05160	5/16-18 x 5	25	
ACU05176	5/16-18 x 5 1/2	25	
ACU05192	5/16-18 x 6	25	
ACU05208	5/16-18 x 6 1/2	25	
ACU05224	5/16-18 x 7	25	
ACU05240	5/16-18 x 7 1/2	25	
ACU05256	5/16-18 x 8	25	
ACU06016	3/8-16 x 1/2	100	
ACU06020	3/8-16 x 5/8	100	
ACU06024	3/8-16 x 3/4	100	
ACU06028	3/8-16 x 7/8	100	
ACU06032	3/8-16 x 1	100	
ACU06040	3/8-16 x 1 1/4	100	
ACU06048	3/8-16 x 1 1/2	100	
ACU06056	3/8-16 x 1 3/4	50	
ACU06064	3/8-16 x 2	50	
ACU06072	3/8-16 x 2 1/4	50	
ACU06080	3/8-16 x 2 1/2	50	
ACU06088	3/8-16 x 2 3/4	50	
ACU06096	3/8-16 x 3	50	
ACU06104	3/8-16 x 3 1/4	25	
ACU06112	3/8-16 x 3 1/2	25	
ACU06120	3/8-16 x 3 3/4	25	
ACU06128	3/8-16 x 4	25	
ACU06144	3/8-16 x 4 1/2	25	
ACU06160	3/8-16 x 5	25	
ACU06176	3/8-16 x 5 1/2	25	
ACU06192	3/8-16 x 6	25	

(continued...)

**GRADE 2 HEX MACHINE BOLT (cont.)**

ZINC PLATED, UNC

Line: 139-00

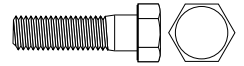

PART NUMBER	SIZE	QTY/BX	LIST PRICE
ACU06208	3/8-16 x 6 1/2	25	
ACU06224	3/8-16 x 7	25	
ACU06240	3/8-16 x 7 1/2	25	
ACU06256	3/8-16 x 8	25	
ACU06320	3/8-16 x 10	25	
ACU07024	7/16-14 x 3/4	50	
ACU07032	7/16-14 x 1	50	
ACU07040	7/16-14 x 1 1/4	50	
ACU07048	7/16-14 x 1 1/2	50	
ACU07056	7/16-14 x 1 3/4	50	
ACU07064	7/16-14 x 2	50	
ACU07072	7/16-14 x 2 1/4	25	
ACU07080	7/16-14 x 2 1/2	25	
ACU07088	7/16-14 x 2 3/4	25	
ACU07096	7/16-14 x 3	25	
ACU07104	7/16-14 x 3 1/4	25	
ACU07112	7/16-14 x 3 1/2	25	
ACU07120	7/16-14 x 3 3/4	25	
ACU07128	7/16-14 x 4	25	
ACU07144	7/16-14 x 4 1/2	25	
ACU07160	7/16-14 x 5	25	
ACU07176	7/16-14 x 5 1/2	25	
ACU07192	7/16-14 x 6	25	
ACU07208	7/16-14 x 6 1/2	25	
ACU07224	7/16-14 x 7	25	
ACU07240	7/16-14 x 7 1/2	25	
ACU07256	7/16-14 x 8	25	
ACU08024	1/2-13 x 3/4	50	
ACU08028	1/2-13 x 7/8	50	
ACU08032	1/2-13 x 1	50	
ACU08040	1/2-13 x 1 1/4	50	
ACU08048	1/2-13 x 1 1/2	50	
ACU08056	1/2-13 x 1 3/4	50	
ACU08064	1/2-13 x 2	50	
ACU08072	1/2-13 x 2 1/4	25	
ACU08080	1/2-13 x 2 1/2	25	
ACU08088	1/2-13 x 2 3/4	25	
ACU08096	1/2-13 x 3	25	
ACU08104	1/2-13 x 3 1/4	25	
ACU08112	1/2-13 x 3 1/2	25	
ACU08120	1/2-13 x 3 3/4	25	
ACU08128	1/2-13 x 4	25	
ACU08144	1/2-13 x 4 1/2	25	
ACU08160	1/2-13 x 5	25	

(continued...)

**GRADE 2 HEX MACHINE BOLT** (cont.)

ZINC PLATED, UNC

Line: 139-00

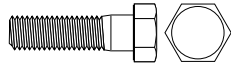

**GRADE 2 HEX MACHINE BOLT** (cont.)

ZINC PLATED, UNC

Line: 139-00

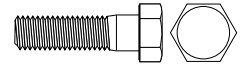

PART NUMBER	SIZE	QTY/BX	LIST PRICE
ACU08176	1/2-13 x 5 1/2	25	
ACU08192	1/2-13 x 6	25	
ACU08208	1/2-13 x 6 1/2	25	
ACU08224	1/2-13 x 7	25	
ACU08240	1/2-13 x 7 1/2	25	
ACU08256	1/2-13 x 8	25	
ACU08288	1/2-13 x 9	10	
ACU08320	1/2-13 x 10	25	
ACU08352	1/2-13 x 11	25	
ACU08384	1/2-13 x 12	25	
ACU10032	5/8-11 x 1	25	
ACU10040	5/8-11 x 1 1/4	25	
ACU10048	5/8-11 x 1 1/2	25	
ACU10056	5/8-11 x 1 3/4	25	
ACU10064	5/8-11 x 2	25	
ACU10072	5/8-11 x 2 1/4	25	
ACU10080	5/8-11 x 2 1/2	25	
ACU10088	5/8-11 x 2 3/4	25	
ACU10096	5/8-11 x 3	25	
ACU10104	5/8-11 x 3 1/4	25	
ACU10112	5/8-11 x 3 1/2	25	
ACU10120	5/8-11 x 3 3/4	25	
ACU10128	5/8-11 x 4	25	
ACU10144	5/8-11 x 4 1/2	25	
ACU10160	5/8-11 x 5	25	
ACU10176	5/8-11 x 5 1/2	25	
ACU10192	5/8-11 x 6	25	
ACU10208	5/8-11 x 6 1/2	25	
ACU10224	5/8-11 x 7	25	
ACU10240	5/8-11 x 7 1/2	25	
ACU10256	5/8-11 x 8	25	
ACU10320	5/8-11 x 10	25	
ACU10384	5/8-11 x 12	25	
ACU12032	3/4-10 x 1	25	
ACU12040	3/4-10 x 1 1/4	25	
ACU12048	3/4-10 x 1 1/2	25	
ACU12056	3/4-10 x 1 3/4	25	
ACU12064	3/4-10 x 2	25	
ACU12072	3/4-10 x 2 1/4	25	
ACU12080	3/4-10 x 2 1/2	25	
ACU12088	3/4-10 x 2 3/4	25	
ACU12096	3/4-10 x 3	25	
ACU12104	3/4-10 x 3 1/4	25	
ACU12112	3/4-10 x 3 1/2	25	

(continued...)

PART NUMBER	SIZE	QTY/BX	LIST PRICE
ACU12120	3/4-10 x 3 3/4	25	
ACU12128	3/4-10 x 4	25	
ACU12144	3/4-10 x 4 1/2	10	
ACU12160	3/4-10 x 5	10	
ACU12176	3/4-10 x 5 1/2	10	
ACU12192	3/4-10 x 6	10	
ACU12208	3/4-10 x 6 1/2	10	
ACU12224	3/4-10 x 7	10	
ACU12240	3/4-10 x 7 1/2	10	
ACU12256	3/4-10 x 8	10	
ACU12272X	3/4-10 x 8 1/2	10	
ACU12288	3/4-10 x 9	10	
ACU12320	3/4-10 x 10	10	
ACU12352X	3/4-10 x 11	10	
ACU12384	3/4-10 x 12	10	
ACU14048	7/8-9 x 1 1/2	15	
ACU14056	7/8-9 x 1 3/4	15	
ACU14064	7/8-9 x 2	15	
ACU14072	7/8-9 x 2 1/4	15	
ACU14080	7/8-9 x 2 1/2	15	
ACU14088	7/8-9 x 2 3/4	15	
ACU14096	7/8-9 x 3	15	
ACU14104	7/8-9 x 3 1/4	15	
ACU14112	7/8-9 x 3 1/2	15	
ACU14120	7/8-9 x 3 3/4	15	
ACU14128	7/8-9 x 4	10	
ACU14144	7/8-9 x 4 1/2	10	
ACU14160	7/8-9 x 5	10	
ACU14176	7/8-9 x 5 1/2	10	
ACU14192	7/8-9 x 6	10	
ACU14208	7/8-9 x 6 1/2	10	
ACU14224	7/8-9 x 7	10	
ACU14240	7/8-9 x 7 1/2	10	
ACU14256	7/8-9 x 8	10	
ACU16056	1-8 x 1 3/4	10	
ACU16064	1-8 x 2	10	
ACU16072	1-8 x 2 1/4	10	
ACU16080	1-8 x 2 1/2	10	
ACU16088	1-8 x 2 3/4	10	
ACU16096	1-8 x 3	10	
ACU16104	1-8 x 3 1/4	10	
ACU16112	1-8 x 3 1/2	10	
ACU16120X	1-8 x 3 3/4	10	
ACU16128	1-8 x 4	10	

(continued...)

**GRADE 2 HEX MACHINE BOLT (cont.)**

ZINC PLATED, UNC

Line: 139-00

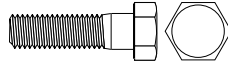

PART NUMBER	SIZE	QTY/BX	LIST PRICE
ACU16144	1-8 x 4 1/2	10	
ACU16160	1-8 x 5	10	
ACU16176	1-8 x 5 1/2	10	
ACU16192	1-8 x 6	10	
ACU16208	1-8 x 6 1/2	10	
ACU16224	1-8 x 7	10	
ACU16240	1-8 x 7 1/2	5	
ACU16256	1-8 x 8	5	
ACU18096	1 1/8-7 x 3	10	
ACU18112	1 1/8-7 x 3 1/2	10	
ACU18128	1 1/8-7 x 4	10	
ACU18144	1 1/8-7 x 4 1/2	10	
ACU18160	1 1/8-7 x 5	10	
ACU18176	1 1/8-7 x 5 1/2	10	
ACU18192	1 1/8-7 x 6	5	
ACU18208	1 1/8-7 x 6 1/2	5	
ACU18224	1 1/8-7 x 7	5	
ACU18240	1 1/8-7 x 7 1/2	5	
ACU18256	1 1/8-7 x 8	5	
ACU18288	1 1/8-7 x 9	5	
ACU18320	1 1/8-7 x 10	5	
ACU18352	1 1/8-7 x 11	1	
ACU18384	1 1/8-7 x 12	1	
ACU20080	1 1/4-7 x 2 1/2	5	
ACU20096	1 1/4-7 x 3	5	
ACU20112	1 1/4-7 x 3 1/2	5	
ACU20128	1 1/4-7 x 4	5	
ACU20144	1 1/4-7 x 4 1/2	5	
ACU20160	1 1/4-7 x 5	5	
ACU20176	1 1/4-7 x 5 1/2	5	
ACU20192	1 1/4-7 x 6	5	
ACU20208	1 1/4-7 x 6 1/2	5	
ACU20224	1 1/4-7 x 7	5	
ACU20240	1 1/4-7 x 7 1/2	5	
ACU20256	1 1/4-7 x 8	5	
ACU20288	1 1/4-7 x 9	5	
ACU20320	1 1/4-7 x 10	5	
ACU20384	1 1/4-7 x 12	1	
ACU24128	1 1/2-6 x 4	1	
ACU24144	1 1/2-6 x 4 1/2	1	
ACU24160	1 1/2-6 x 5	1	
ACU24176	1 1/2-6 x 5 1/2	1	
ACU24192	1 1/2-6 x 6	1	
ACU24208	1 1/2-6 x 6 1/2	1	

(continued...)

**GRADE 2 HEX MACHINE BOLT (cont.)**

ZINC PLATED, UNC

Line: 139-00

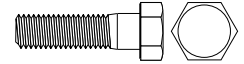

PART NUMBER	SIZE	QTY/BX	LIST PRICE
ACU24224	1 1/2-6 x 7	1	
ACU24240	1 1/2-6 x 7 1/2	1	
ACU24256	1 1/2-6 x 8	1	
ACU24320	1 1/2-6 x 10	1	
ACU24384	1 1/2-6 x 12	1	

**GRADE 2 HEX MACHINE BOLT**

HOT-DIP GALVANIZED, UNC

Line: 139-05

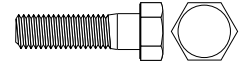

PART NUMBER	SIZE	QTY/BX	LIST PRICE
JEP04024	1/4-20 x 3/4	100	
JEP04032	1/4-20 x 1	100	
JEP04040	1/4-20 x 1 1/4	100	
JEP04048	1/4-20 x 1 1/2	100	
JEP04064	1/4-20 x 2	100	
JEP04080	1/4-20 x 2 1/2	50	
JEP04096	1/4-20 x 3	50	
JEP04112	1/4-20 x 3 1/2	50	
JEP04120	1/4-20 x 3 3/4	50	
JEP04128	1/4-20 x 4	50	
JEP04144	1/4-20 x 4 1/2	50	
JEP04160	1/4-20 x 5	50	
JEP04176	1/4-20 x 5 1/2	50	
JEP04192	1/4-20 x 6	50	
JEP04208	1/4-20 x 6 1/2	25	
JEP04224	1/4-20 x 7	25	
JEP05024	5/16-18 x 3/4	100	
JEP05032	5/16-18 x 1	100	
JEP05040	5/16-18 x 1 1/4	100	
JEP05048	5/16-18 x 1 1/2	100	
JEP05064	5/16-18 x 2	100	
JEP05080	5/16-18 x 2 1/2	50	
JEP05096	5/16-18 x 3	50	
JEP05112	5/16-18 x 3 1/2	50	
JEP05128	5/16-18 x 4	25	
JEP05144	5/16-18 x 4 1/2	25	
JEP05160	5/16-18 x 5	25	
JEP05176	5/16-18 x 5 1/2	25	
JEP05192	5/16-18 x 6	25	
JEP05208	5/16-18 x 6 1/2	25	
JEP05224	5/16-18 x 7	25	
JEP05256	5/16-18 x 8	25	
JEP06024	3/8-16 x 3/4	100	
JEP06032	3/8-16 x 1	100	
JEP06040	3/8-16 x 1 1/4	100	

(continued...)

**GRADE 2 HEX MACHINE BOLT** (cont.)

HOT-DIP GALVANIZED, UNC

Line: 139-05

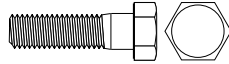

**GRADE 2 HEX MACHINE BOLT** (cont.)

HOT-DIP GALVANIZED, UNC

Line: 139-05

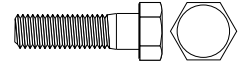

PART NUMBER	SIZE	QTY/BX	LIST PRICE
JEP06048	3/8-16 x 1 1/2	100	
JEP06064	3/8-16 x 2	50	
JEP06080	3/8-16 x 2 1/2	50	
JEP06096	3/8-16 x 3	50	
JEP06112	3/8-16 x 3 1/2	50	
JEP06128	3/8-16 x 4	25	
JEP06144	3/8-16 x 4 1/2	25	
JEP06160	3/8-16 x 5	25	
JEP06176	3/8-16 x 5 1/2	25	
JEP06192	3/8-16 x 6	25	
JEP06224	3/8-16 x 7	25	
JEP06256	3/8-16 x 8	25	
JEP06320	3/8-16 x 10	25	
JEP06352	3/8-16 x 11	25	
JEP06384	3/8-16 x 12	25	
JEP08032	1/2-13 x 1	50	
JEP08040	1/2-13 x 1 1/4	50	
JEP08048	1/2-13 x 1 1/2	50	
JEP08056X	1/2-13 x 1 3/4	50	
JEP08064	1/2-13 x 2	50	
JEP08080	1/2-13 x 2 1/2	25	
JEP08096	1/2-13 x 3	25	
JEP08112	1/2-13 x 3 1/2	25	
JEP08128	1/2-13 x 4	25	
JEP08144	1/2-13 x 4 1/2	25	
JEP08160	1/2-13 x 5	25	
JEP08176	1/2-13 x 5 1/2	25	
JEP08192	1/2-13 x 6	25	
JEP08208	1/2-13 x 6 1/2	25	
JEP08224	1/2-13 x 7	25	
JEP08256	1/2-13 x 8	25	
JEP08272	1/2-13 x 8 1/2	25	
JEP08288	1/2-13 x 9	25	
JEP08320	1/2-13 x 10	25	
JEP08352	1/2-13 x 11	25	
JEP08384	1/2-13 x 12	25	
JEP08448	1/2-13 x 14	25	
JEP08480	1/2-13 x 15	25	
JEP08512	1/2-13 x 16	25	
JEP08576	1/2-13 x 18	1	
JEP08640	1/2-13 x 20	1	
JEP10032	5/8-11 x 1	25	
JEP10040	5/8-11 x 1 1/4	25	
JEP10048	5/8-11 x 1 1/2	25	

(continued...)

PART NUMBER	SIZE	QTY/BX	LIST PRICE
JEP10056	5/8-11 x 1 3/4	25	
JEP10064	5/8-11 x 2	25	
JEP10080	5/8-11 x 2 1/2	25	
JEP10088	5/8-11 x 2 3/4	25	
JEP10096	5/8-11 x 3	25	
JEP10104	5/8-11 x 3 1/4	25	
JEP10112	5/8-11 x 3 1/2	25	
JEP10128	5/8-11 x 4	25	
JEP10144	5/8-11 x 4 1/2	25	
JEP10160	5/8-11 x 5	25	
JEP10176	5/8-11 x 5 1/2	25	
JEP10192	5/8-11 x 6	25	
JEP10208	5/8-11 x 6 1/2	25	
JEP10224	5/8-11 x 7	25	
JEP10256	5/8-11 x 8	25	
JEP10288	5/8-11 x 9	10	
JEP10320	5/8-11 x 10	10	
JEP10352	5/8-11 x 11	10	
JEP10384	5/8-11 x 12	10	
JEP10416	5/8-11 x 13	10	
JEP10448	5/8-11 x 14	10	
JEP10480	5/8-11 x 15	10	
JEP10512	5/8-11 x 16	10	
JEP10576	5/8-11 x 18	1	
JEP10640	5/8-11 x 20	10	
JEP10768	5/8-11 x 24	1	
JEP12048	3/4-10 x 1 1/2	25	
JEP12056X	3/4-10 x 1 3/4	25	
JEP12064	3/4-10 x 2	25	
JEP12080	3/4-10 x 2 1/2	25	
JEP12096	3/4-10 x 3	25	
JEP12112	3/4-10 x 3 1/2	25	
JEP12128	3/4-10 x 4	25	
JEP12144	3/4-10 x 4 1/2	10	
JEP12160	3/4-10 x 5	10	
JEP12176	3/4-10 x 5 1/2	10	
JEP12192	3/4-10 x 6	10	
JEP12208	3/4-10 x 6 1/2	10	
JEP12224	3/4-10 x 7	10	
JEP12240	3/4-10 x 7 1/2	10	
JEP12256	3/4-10 x 8	10	
JEP12288	3/4-10 x 9	10	
JEP12320	3/4-10 x 10	10	
JEP12352	3/4-10 x 11	10	

(continued...)



**GRADE 2 HEX MACHINE BOLT** (cont.)

HOT-DIP GALVANIZED, UNC

Line: 139-05

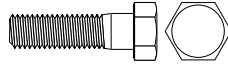

PART NUMBER	SIZE	QTY/BX	LIST PRICE
JEP12384	3/4-10 x 12	10	
JEP12448	3/4-10 x 14	10	
JEP12512	3/4-10 x 16	10	
JEP12576	3/4-10 x 18	1	
JEP12640	3/4-10 x 20	1	
JEP12704	3/4-10 x 22	1	
JEP12768	3/4-10 x 24	1	
JEP14064	7/8-9 x 2	10	
JEP14080	7/8-9 x 2 1/2	15	
JEP14096	7/8-9 x 3	10	
JEP14112	7/8-9 x 3 1/2	10	
JEP14128	7/8-9 x 4	10	
JEP14144	7/8-9 x 4 1/2	10	
JEP14160	7/8-9 x 5	10	
JEP14176	7/8-9 x 5 1/2	10	
JEP14192	7/8-9 x 6	10	
JEP14224	7/8-9 x 7	10	
JEP14256	7/8-9 x 8	10	
JEP14304	7/8-9 x 9 1/2	10	
JEP14320	7/8-9 x 10	10	
JEP14384	7/8-9 x 12	10	
JEP14448	7/8-9 x 14	1	
JEP14512	7/8-9 x 16	1	
JEP14576	7/8-9 x 18	1	
JEP14640	7/8-9 x 20	1	
JEP16096	1-8 x 3	10	
JEP16112	1-8 x 3 1/2	10	
JEP16128	1-8 x 4	10	
JEP16160	1-8 x 5	10	
JEP16176	1-8 x 5 1/2	10	
JEP16192	1-8 x 6	10	
JEP16224	1-8 x 7	10	
JEP16256	1-8 x 8	10	
JEP16320	1-8 x 10	10	
JEP16384	1-8 x 12	5	
JEP16448	1-8 x 14	1	
JEP16512	1-8 x 16	1	
JEP16576	1-8 x 18	1	
JEP16640	1-8 x 20	1	
JEP16768	1-8 x 24	1	

**GRADE 2 HEX HEAD TAP BOLT**

ZINC PLATED, UNC - FULL THREAD

Line: 140-00

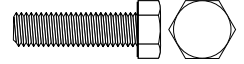

PART NUMBER	SIZE	QTY/BX	LIST PRICE
DNC04024	1/4-20 x 3/4	100	
DNC04032	1/4-20 x 1	100	
DNC04040	1/4-20 x 1 1/4	100	
DNC04048	1/4-20 x 1 1/2	100	
DNC04056	1/4-20 x 1 3/4	100	
DNC04064	1/4-20 x 2	100	
DNC04072	1/4-20 x 2 1/4	50	
DNC04080	1/4-20 x 2 1/2	50	
DNC04088	1/4-20 x 2 3/4	50	
DNC04096	1/4-20 x 3	50	
DNC04104	1/4-20 x 3 1/4	50	
DNC04112	1/4-20 x 3 1/2	50	
DNC04128	1/4-20 x 4	50	
DNC04144	1/4-20 x 4 1/2	50	
DNC04160	1/4-20 x 5	50	
DNC04176	1/4-20 x 5 1/2	50	
DNC04192X	1/4-20 x 6	50	
DNC05032	5/16-18 x 1	100	
DNC05040	5/16-18 x 1 1/4	100	
DNC05048	5/16-18 x 1 1/2	100	
DNC05056	5/16-18 x 1 3/4	100	
DNC05064	5/16-18 x 2	100	
DNC05072	5/16-18 x 2 1/4	50	
DNC05080	5/16-18 x 2 1/2	50	
DNC05088	5/16-18 x 2 3/4	50	
DNC05096	5/16-18 x 3	50	
DNC05112	5/16-18 x 3 1/2	50	
DNC05128	5/16-18 x 4	50	
DNC05144	5/16-18 x 4 1/2	50	
DNC05160X	5/16-18 x 5	25	
DNC05176X	5/16-18 x 5 1/2	25	
DNC05192X	5/16-18 x 6	25	
DNC06032	3/8-16 x 1	100	
DNC06040	3/8-16 x 1 1/4	100	
DNC06048	3/8-16 x 1 1/2	100	
DNC06056	3/8-16 x 1 3/4	50	
DNC06064	3/8-16 x 2	50	
DNC06072	3/8-16 x 2 1/4	50	
DNC06080	3/8-16 x 2 1/2	50	
DNC06088	3/8-16 x 2 3/4	50	
DNC06096	3/8-16 x 3	50	
DNC06112	3/8-16 x 3 1/2	25	
DNC06128	3/8-16 x 4	25	
DNC06144	3/8-16 x 4 1/2	25	

(continued...)

## GRADE 2 HEX HEAD TAP BOLT (cont.)

ZINC PLATED, UNC - FULL THREAD

Line: 140-00

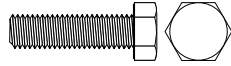

## GRADE 5 HEX TAP BOLT

ZINC PLATED, UNC - GLOBAL

Line: 140-01

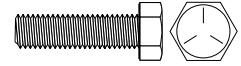

PAGE 3-10

CAP SCREWS - SECTION 03

PART NUMBER	SIZE	QTY/BX	LIST PRICE
DNC06160	3/8-16 x 5	25	
DNC06176	3/8-16 x 5 1/2	25	
DNC06192	3/8-16 x 6	25	
DNC07064	7/16-14 x 2	50	
DNC07080	7/16-14 x 2 1/2	50	
DNC08048	1/2-13 x 1 1/2	50	
DNC08056	1/2-13 x 1 3/4	50	
DNC08064	1/2-13 x 2	50	
DNC08072	1/2-13 x 2 1/4	25	
DNC08080	1/2-13 x 2 1/2	25	
DNC08088	1/2-13 x 2 3/4	25	
DNC08096	1/2-13 x 3	25	
DNC08112	1/2-13 x 3 1/2	25	
DNC08128	1/2-13 x 4	25	
DNC08144	1/2-13 x 4 1/2	25	
DNC08160	1/2-13 x 5	25	
DNC08176	1/2-13 x 5 1/2	25	
DNC08192	1/2-13 x 6	25	
DNC10064	5/8-11 x 2	25	
DNC10072	5/8-11 x 2 1/4	25	
DNC10080	5/8-11 x 2 1/2	25	
DNC10088	5/8-11 x 2 3/4	25	
DNC10096	5/8-11 x 3	25	
DNC10112	5/8-11 x 3 1/2	25	
DNC10120	5/8-11 x 3 3/4	25	
DNC10128	5/8-11 x 4	25	
DNC10144	5/8-11 x 4 1/2	25	
DNC10160	5/8-11 x 5	25	
DNC10176	5/8-11 x 5 1/2	25	
DNC10192	5/8-11 x 6	25	
DNC12080	3/4-10 x 2 1/2	25	
DNC12088	3/4-10 x 2 3/4	25	
DNC12096	3/4-10 x 3	25	
DNC12112	3/4-10 x 3 1/2	25	
DNC12128	3/4-10 x 4	25	
DNC12160	3/4-10 x 5	10	
DNC12192	3/4-10 x 6	10	

PART NUMBER	SIZE	QTY/BX	LIST PRICE
BML04032	1/4-20 x 1	100	
BML04040	1/4-20 x 1 1/4	100	
BML04048	1/4-20 x 1 1/2	100	
BML04056	1/4-20 x 1 3/4	100	
BML04064	1/4-20 x 2	100	
BML04072	1/4-20 x 2 1/4	50	
BML04080	1/4-20 x 2 1/2	50	
BML04088	1/4-20 x 2 3/4	50	
BML04096	1/4-20 x 3	50	
BML05032	5/16-18 x 1	100	
BML05040	5/16-18 x 1 1/4	100	
BML05048	5/16-18 x 1 1/2	100	
BML05056	5/16-18 x 1 3/4	100	
BML05064	5/16-18 x 2	100	
BML05072	5/16-18 x 2 1/4	100	
BML05080	5/16-18 x 2 1/2	50	
BML05088	5/16-18 x 2 3/4	50	
BML05096	5/16-18 x 3	50	
BML06040	3/8-16 x 1 1/4	100	
BML06048	3/8-16 x 1 1/2	100	
BML06056	3/8-16 x 1 3/4	50	
BML06064	3/8-16 x 2	50	
BML06072	3/8-16 x 2 1/4	50	
BML06080	3/8-16 x 2 1/2	25	
BML06088	3/8-16 x 2 3/4	25	
BML06096	3/8-16 x 3	25	
BML06112	3/8-16 x 3 1/2	25	
BML06128	3/8-16 x 4	25	
BML06144	3/8-16 x 4 1/2	25	
BML06160	3/8-16 x 5	25	
BML06176	3/8-16 x 5 1/2	25	
BML06192	3/8-16 x 6	25	
BML08048	1/2-13 x 1 1/2	50	
BML08056	1/2-13 x 1 3/4	50	
BML08064	1/2-13 x 2	50	
BML08072	1/2-13 x 2 1/4	25	
BML08080	1/2-13 x 2 1/2	25	
BML08088	1/2-13 x 2 3/4	25	
BML08096	1/2-13 x 3	25	
BML08112	1/2-13 x 3 1/2	25	
BML08128	1/2-13 x 4	25	
BML08144	1/2-13 x 4 1/2	25	
BML08160	1/2-13 x 5	25	
BML08176	1/2-13 x 5 1/2	25	

(continued...)

**GRADE 5 HEX TAP BOLT (cont.)**

ZINC PLATED, UNC - GLOBAL

Line: 140-01

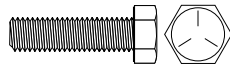

PART NUMBER	SIZE	QTY/BX	LIST PRICE
BML08192	1/2-13 x 6	25	
BML10056	5/8-11 x 1 3/4	25	
BML10064	5/8-11 x 2	25	
BML10072	5/8-11 x 2 1/4	25	
BML10080	5/8-11 x 2 1/2	25	
BML10088	5/8-11 x 2 3/4	25	
BML10096	5/8-11 x 3	25	
BML10104	5/8-11 x 3 1/4	25	
BML10112	5/8-11 x 3 1/2	25	
BML10120	5/8-11 x 3 3/4	25	
BML10128	5/8-11 x 4	25	
BML10160	5/8-11 x 5	25	
BML10192	5/8-11 x 6	25	
BML12064	3/4-10 x 2	25	
BML12072	3/4-10 x 2 1/4	25	
BML12080	3/4-10 x 2 1/2	25	
BML12088	3/4-10 x 2 3/4	25	
BML12096	3/4-10 x 3	10	
BML12104	3/4-10 x 3 1/4	10	
BML12112	3/4-10 x 3 1/2	10	
BML12120	3/4-10 x 3 3/4	10	
BML12128	3/4-10 x 4	10	
BML12160	3/4-10 x 5	10	
BML12192	3/4-10 x 6	10	

**GRADE 5 HEX TAP BOLT**

ZINC PLATED, UNC - MADE IN THE USA

Line: 140-99

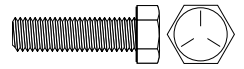

PART NUMBER	SIZE	QTY/BX	LIST PRICE
JJC04040MC	1/4-20 x 1 1/4	100	
JJC04048MC	1/4-20 x 1 1/2	100	
JJC04056MC	1/4-20 x 1 3/4	100	
JJC04064MC	1/4-20 x 2	100	
JJC04072MC	1/4-20 x 2 1/4	100	
JJC04080MC	1/4-20 x 2 1/2	25	
JJC05048MC	5/16-18 x 1 1/2	100	
JJC05056MC	5/16-18 x 1 3/4	100	
JJC05064MC	5/16-18 x 2	50	
JJC05072MC	5/16-18 x 2 1/4	50	
JJC05080MC	5/16-18 x 2 1/2	50	
JJC05096MC	5/16-18 x 3	25	
JJC06048MC	3/8-16 x 1 1/2	50	
JJC06056MC	3/8-16 x 1 3/4	25	
JJC06064MC	3/8-16 x 2	25	
JJC06080MC	3/8-16 x 2 1/2	25	
JJC06096MC	3/8-16 x 3	25	
JJC06112MC	3/8-16 x 3 1/2	25	
JJC08064MC	1/2-13 x 2	10	
JJC08080MC	1/2-13 x 2 1/2	10	
JJC08096MC	1/2-13 x 3	10	
JJC08112MC	1/2-13 x 3 1/2	10	
JJC10080MC	5/8-11 x 2 1/2	5	
JJC10088MC	5/8-11 x 2 3/4	5	
JJC10096MC	5/8-11 x 3	5	
JJC10112MC	5/8-11 x 3 1/2	5	
JJC12096MC	3/4-10 x 3	5	
JJC12112MC	3/4-10 x 3 1/2	5	
JJC12128MC	3/4-10 x 4	5	
JJC12160MC	3/4-10 x 5	5	

**GRADE 5 HEX CAP SCREW**  
 ZINC PLATED, UNC - MADE IN THE USA  
 Line: 143-00

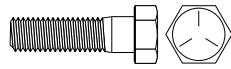

**GRADE 5 HEX CAP SCREW (cont.)**  
 ZINC PLATED, UNC - MADE IN THE USA  
 Line: 143-00

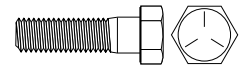

PAGE 3-12

CAP SCREWS - SECTION 03

PART NUMBER	SIZE	QTY/BX	LIST PRICE
AEU04016	1/4-20 x 1/2	100	
AEU04020	1/4-20 x 5/8	100	
AEU04024	1/4-20 x 3/4	100	
AEU04028	1/4-20 x 7/8	100	
AEU04032	1/4-20 x 1	100	
AEU04040	1/4-20 x 1 1/4	100	
AEU04048	1/4-20 x 1 1/2	100	
AEU04056	1/4-20 x 1 3/4	100	
AEU04064	1/4-20 x 2	100	
AEU04072	1/4-20 x 2 1/4	50	
AEU04080	1/4-20 x 2 1/2	50	
AEU04088	1/4-20 x 2 3/4	50	
AEU04096	1/4-20 x 3	50	
AEU04104	1/4-20 x 3 1/4	50	
AEU04112	1/4-20 x 3 1/2	50	
AEU04120	1/4-20 x 3 3/4	50	
AEU04128	1/4-20 x 4	50	
AEU04144	1/4-20 x 4 1/2	50	
AEU04160	1/4-20 x 5	50	
AEU04176	1/4-20 x 5 1/2	50	
AEU04192	1/4-20 x 6	50	
AEU04224	1/4-20 x 7	25	
AEU04256	1/4-20 x 8	25	
AEU05016	5/16-18 x 1/2	100	
AEU05020	5/16-18 x 5/8	100	
AEU05024	5/16-18 x 3/4	100	
AEU05028	5/16-18 x 7/8	100	
AEU05032	5/16-18 x 1	100	
AEU05036	5/16-18 x 1 1/8	100	
AEU05040	5/16-18 x 1 1/4	100	
AEU05044	5/16-18 x 1 3/8	100	
AEU05048	5/16-18 x 1 1/2	100	
AEU05056	5/16-18 x 1 3/4	100	
AEU05064	5/16-18 x 2	100	
AEU05072	5/16-18 x 2 1/4	50	
AEU05080	5/16-18 x 2 1/2	50	
AEU05088	5/16-18 x 2 3/4	50	
AEU05096	5/16-18 x 3	50	
AEU05104	5/16-18 x 3 1/4	50	
AEU05112	5/16-18 x 3 1/2	50	
AEU05120	5/16-18 x 3 3/4	50	
AEU05128	5/16-18 x 4	50	
AEU05136	5/16-18 x 4 1/4	50	
AEU05144	5/16-18 x 4 1/2	50	

(continued...)

PART NUMBER	SIZE	QTY/BX	LIST PRICE
AEU05160	5/16-18 x 5	50	
AEU05176	5/16-18 x 5 1/2	25	
AEU05192	5/16-18 x 6	25	
AEU05208	5/16-18 x 6 1/2	25	
AEU05224	5/16-18 x 7	25	
AEU05256	5/16-18 x 8	25	
AEU06016	3/8-16 x 1/2	100	
AEU06020	3/8-16 x 5/8	100	
AEU06024	3/8-16 x 3/4	100	
AEU06028	3/8-16 x 7/8	100	
AEU06032	3/8-16 x 1	100	
AEU06036	3/8-16 x 1 1/8	100	
AEU06040	3/8-16 x 1 1/4	100	
AEU06044	3/8-16 x 1 3/8	100	
AEU06048	3/8-16 x 1 1/2	100	
AEU06056	3/8-16 x 1 3/4	50	
AEU06060	3/8-16 x 1 7/8	50	
AEU06064	3/8-16 x 2	50	
AEU06072	3/8-16 x 2 1/4	50	
AEU06080	3/8-16 x 2 1/2	50	
AEU06088	3/8-16 x 2 3/4	50	
AEU06096	3/8-16 x 3	50	
AEU06104	3/8-16 x 3 1/4	25	
AEU06112	3/8-16 x 3 1/2	25	
AEU06120	3/8-16 x 3 3/4	25	
AEU06128	3/8-16 x 4	25	
AEU06136	3/8-16 x 4 1/4	25	
AEU06144	3/8-16 x 4 1/2	25	
AEU06152	3/8-16 x 4 3/4	25	
AEU06160	3/8-16 x 5	25	
AEU06168	3/8-16 x 5 1/4	25	
AEU06176	3/8-16 x 5 1/2	25	
AEU06184	3/8-16 x 5 3/4	25	
AEU06192	3/8-16 x 6	25	
AEU06208	3/8-16 x 6 1/2	25	
AEU06224	3/8-16 x 7	25	
AEU06240	3/8-16 x 7 1/2	25	
AEU06256	3/8-16 x 8	25	
AEU07024	7/16-14 x 3/4	50	
AEU07028	7/16-14 x 7/8	50	
AEU07032	7/16-14 x 1	50	
AEU07036	7/16-14 x 1 1/8	50	
AEU07040	7/16-14 x 1 1/4	50	
AEU07048	7/16-14 x 1 1/2	50	

(continued...)

**GRADE 5 HEX CAP SCREW (cont.)**

ZINC PLATED, UNC - MADE IN THE USA

Line: 143-00

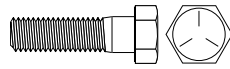

PART NUMBER	SIZE	QTY/BX	LIST PRICE
AEU07056	7/16-14 x 1 3/4	50	
AEU07064	7/16-14 x 2	50	
AEU07072	7/16-14 x 2 1/4	25	
AEU07080	7/16-14 x 2 1/2	25	
AEU07088	7/16-14 x 2 3/4	25	
AEU07096	7/16-14 x 3	25	
AEU07104	7/16-14 x 3 1/4	25	
AEU07112	7/16-14 x 3 1/2	25	
AEU07120	7/16-14 x 3 3/4	25	
AEU07128	7/16-14 x 4	25	
AEU07144	7/16-14 x 4 1/2	25	
AEU07160	7/16-14 x 5	25	
AEU07176	7/16-14 x 5 1/2	25	
AEU07192	7/16-14 x 6	25	
AEU07208	7/16-14 x 6 1/2	25	
AEU07224	7/16-14 x 7	25	
AEU07240	7/16-14 x 7 1/2	25	
AEU07256	7/16-14 x 8	25	
AEU08024	1/2-13 x 3/4	50	
AEU08028	1/2-13 x 7/8	50	
AEU08032	1/2-13 x 1	50	
AEU08040	1/2-13 x 1 1/4	50	
AEU08044	1/2-13 x 1 3/8	50	
AEU08048	1/2-13 x 1 1/2	50	
AEU08056	1/2-13 x 1 3/4	50	
AEU08064	1/2-13 x 2	50	
AEU08072	1/2-13 x 2 1/4	25	
AEU08080	1/2-13 x 2 1/2	25	
AEU08088	1/2-13 x 2 3/4	25	
AEU08096	1/2-13 x 3	25	
AEU08104	1/2-13 x 3 1/4	25	
AEU08112	1/2-13 x 3 1/2	25	
AEU08120	1/2-13 x 3 3/4	25	
AEU08128	1/2-13 x 4	25	
AEU08136	1/2-13 x 4 1/4	25	
AEU08144	1/2-13 x 4 1/2	25	
AEU08152	1/2-13 x 4 3/4	25	
AEU08160	1/2-13 x 5	25	
AEU08168	1/2-13 x 5 1/4	25	
AEU08176	1/2-13 x 5 1/2	25	
AEU08184	1/2-13 x 5 3/4	25	
AEU08192	1/2-13 x 6	25	
AEU08208	1/2-13 x 6 1/2	25	
AEU08224	1/2-13 x 7	25	

(continued...)

**GRADE 5 HEX CAP SCREW (cont.)**

ZINC PLATED, UNC - MADE IN THE USA

Line: 143-00

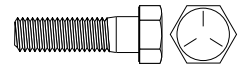

PART NUMBER	SIZE	QTY/BX	LIST PRICE
AEU08240	1/2-13 x 7 1/2	25	
AEU08256	1/2-13 x 8	25	
AEU09032	9/16-12 x 1	25	
AEU09040	9/16-12 x 1 1/4	25	
AEU09048	9/16-12 x 1 1/2	25	
AEU09056	9/16-12 x 1 3/4	25	
AEU09064	9/16-12 x 2	25	
AEU09072	9/16-12 x 2 1/4	25	
AEU09080	9/16-12 x 2 1/2	25	
AEU09088	9/16-12 x 2 3/4	25	
AEU09096	9/16-12 x 3	25	
AEU09104	9/16-12 x 3 1/4	25	
AEU09112	9/16-12 x 3 1/2	25	
AEU09120	9/16-12 x 3 3/4	25	
AEU09128	9/16-12 x 4	25	
AEU09144	9/16-12 x 4 1/2	25	
AEU09160	9/16-12 x 5	25	
AEU09176	9/16-12 x 5 1/2	25	
AEU09192	9/16-12 x 6	25	
AEU09208	9/16-12 x 6 1/2	25	
AEU09224	9/16-12 x 7	25	
AEU09240	9/16-12 x 7 1/2	25	
AEU09256	9/16-12 x 8	25	
AEU10032	5/8-11 x 1	25	
AEU10040	5/8-11 x 1 1/4	25	
AEU10048	5/8-11 x 1 1/2	25	
AEU10056	5/8-11 x 1 3/4	25	
AEU10064	5/8-11 x 2	25	
AEU10072	5/8-11 x 2 1/4	25	
AEU10080	5/8-11 x 2 1/2	25	
AEU10088	5/8-11 x 2 3/4	25	
AEU10096	5/8-11 x 3	25	
AEU10104	5/8-11 x 3 1/4	25	
AEU10112	5/8-11 x 3 1/2	25	
AEU10120	5/8-11 x 3 3/4	25	
AEU10128	5/8-11 x 4	25	
AEU10136	5/8-11 x 4 1/4	25	
AEU10144	5/8-11 x 4 1/2	25	
AEU10160	5/8-11 x 5	25	
AEU10168	5/8-11 x 5 1/4	25	
AEU10176	5/8-11 x 5 1/2	25	
AEU10184	5/8-11 x 5 3/4	25	
AEU10192	5/8-11 x 6	25	
AEU10208	5/8-11 x 6 1/2	25	

(continued...)

**GRADE 5 HEX CAP SCREW (cont.)**

ZINC PLATED, UNC - MADE IN THE USA

Line: 143-00

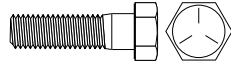
**GRADE 5 HEX CAP SCREW (cont.)**

ZINC PLATED, UNC - MADE IN THE USA

Line: 143-00

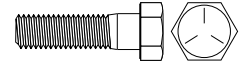

PART NUMBER	SIZE	QTY/BX	LIST PRICE
AEU10224	5/8-11 x 7	25	
AEU10240	5/8-11 x 7 1/2	25	
AEU10256	5/8-11 x 8	25	
AEU10272	5/8-11 x 8 1/2	25	
AEU10288	5/8-11 x 9	10	
AEU10304	5/8-11 x 9 1/2	10	
AEU10320	5/8-11 x 10	10	
AEU10384	5/8-11 x 12	1	
AEU12032	3/4-10 x 1	25	
AEU12040	3/4-10 x 1 1/4	25	
AEU12048	3/4-10 x 1 1/2	25	
AEU12056	3/4-10 x 1 3/4	25	
AEU12064	3/4-10 x 2	25	
AEU12072	3/4-10 x 2 1/4	25	
AEU12080	3/4-10 x 2 1/2	25	
AEU12088	3/4-10 x 2 3/4	25	
AEU12096	3/4-10 x 3	25	
AEU12104	3/4-10 x 3 1/4	25	
AEU12112	3/4-10 x 3 1/2	25	
AEU12120	3/4-10 x 3 3/4	25	
AEU12128	3/4-10 x 4	25	
AEU12136	3/4-10 x 4 1/4	10	
AEU12144	3/4-10 x 4 1/2	10	
AEU12152	3/4-10 x 4 3/4	10	
AEU12160	3/4-10 x 5	10	
AEU12176	3/4-10 x 5 1/2	10	
AEU12192	3/4-10 x 6	10	
AEU12208	3/4-10 x 6 1/2	10	
AEU12224	3/4-10 x 7	10	
AEU12240	3/4-10 x 7 1/2	10	
AEU12256	3/4-10 x 8	10	
AEU12272	3/4-10 x 8 1/2	10	
AEU12288	3/4-10 x 9	10	
AEU12304	3/4-10 x 9 1/2	10	
AEU12320	3/4-10 x 10	10	
AEU14048	7/8-9 x 1 1/2	15	
AEU14056	7/8-9 x 1 3/4	15	
AEU14064	7/8-9 x 2	15	
AEU14072	7/8-9 x 2 1/4	15	
AEU14080	7/8-9 x 2 1/2	15	
AEU14088	7/8-9 x 2 3/4	15	
AEU14096	7/8-9 x 3	15	
AEU14104	7/8-9 x 3 1/4	15	
AEU14112	7/8-9 x 3 1/2	15	

(continued...)

PART NUMBER	SIZE	QTY/BX	LIST PRICE
AEU14120	7/8-9 x 3 3/4	15	
AEU14128	7/8-9 x 4	15	
AEU14144	7/8-9 x 4 1/2	10	
AEU14152	7/8-9 x 4 3/4	10	
AEU14160	7/8-9 x 5	10	
AEU14176	7/8-9 x 5 1/2	10	
AEU14192	7/8-9 x 6	10	
AEU14208	7/8-9 x 6 1/2	10	
AEU14224	7/8-9 x 7	10	
AEU14240	7/8-9 x 7 1/2	10	
AEU14256	7/8-9 x 8	10	
AEU14272	7/8-9 x 8 1/2	10	
AEU14288	7/8-9 x 9	10	
AEU14304	7/8-9 x 9 1/2	10	
AEU14320	7/8-9 x 10	10	
AEU16048	1-8 x 1 1/2	10	
AEU16056	1-8 x 1 3/4	10	
AEU16064	1-8 x 2	10	
AEU16072	1-8 x 2 1/4	10	
AEU16080	1-8 x 2 1/2	10	
AEU16088	1-8 x 2 3/4	10	
AEU16096	1-8 x 3	10	
AEU16104	1-8 x 3 1/4	10	
AEU16112	1-8 x 3 1/2	10	
AEU16120	1-8 x 3 3/4	10	
AEU16128	1-8 x 4	10	
AEU16136	1-8 x 4 1/4	10	
AEU16144	1-8 x 4 1/2	10	
AEU16160	1-8 x 5	10	
AEU16176	1-8 x 5 1/2	10	
AEU16192	1-8 x 6	10	
AEU16208	1-8 x 6 1/2	10	
AEU16224	1-8 x 7	10	
AEU16240	1-8 x 7 1/2	5	
AEU16256	1-8 x 8	5	
AEU16272	1-8 x 8 1/2	5	
AEU16288	1-8 x 9	5	
AEU16304	1-8 x 9 1/2	5	
AEU16320	1-8 x 10	5	
AEU18064	1 1/8-7 x 2	5	
AEU18072	1 1/8-7 x 2 1/4	5	
AEU18080	1 1/8-7 x 2 1/2	5	
AEU18088	1 1/8-7 x 2 3/4	5	
AEU18096	1 1/8-7 x 3	5	

(continued...)

**GRADE 5 HEX CAP SCREW (cont.)**

ZINC PLATED, UNC - MADE IN THE USA

Line: 143-00

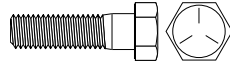

PART NUMBER	SIZE	QTY/BX	LIST PRICE
AEU18104	1 1/8-7 x 3 1/4	5	
AEU18112	1 1/8-7 x 3 1/2	5	
AEU18120	1 1/8-7 x 3 3/4	5	
AEU18128	1 1/8-7 x 4	5	
AEU18144	1 1/8-7 x 4 1/2	5	
AEU18160	1 1/8-7 x 5	5	
AEU18176	1 1/8-7 x 5 1/2	5	
AEU18192	1 1/8-7 x 6	5	
AEU18208	1 1/8-7 x 6 1/2	5	
AEU18224	1 1/8-7 x 7	5	
AEU18256	1 1/8-7 x 8	5	
AEU18272	1 1/8-7 x 8 1/2	5	
AEU18288	1 1/8-7 x 9	5	
AEU18304	1 1/8-7 x 9 1/2	5	
AEU18320	1 1/8-7 x 10	5	
AEU20064	1 1/4-7 x 2	5	
AEU20072	1 1/4-7 x 2 1/4	5	
AEU20080	1 1/4-7 x 2 1/2	5	
AEU20088	1 1/4-7 x 2 3/4	5	
AEU20096	1 1/4-7 x 3	5	
AEU20104	1 1/4-7 x 3 1/4	5	
AEU20112	1 1/4-7 x 3 1/2	5	
AEU20120	1 1/4-7 x 3 3/4	5	
AEU20128	1 1/4-7 x 4	5	
AEU20144	1 1/4-7 x 4 1/2	5	
AEU20160	1 1/4-7 x 5	5	
AEU20176	1 1/4-7 x 5 1/2	5	
AEU20192	1 1/4-7 x 6	5	
AEU20208	1 1/4-7 x 6 1/2	5	
AEU20224	1 1/4-7 x 7	5	
AEU20240	1 1/4-7 x 7 1/2	5	
AEU20256	1 1/4-7 x 8	5	
AEU20272	1 1/4-7 x 8 1/2	5	
AEU20288	1 1/4-7 x 9	5	
AEU20304	1 1/4-7 x 9 1/2	5	
AEU20320	1 1/4-7 x 10	5	

**GRADE 5 HEX CAP SCREW**

ZINC PLATED, UNF - MADE IN THE USA

Line: 144-00

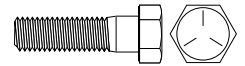

PART NUMBER	SIZE	QTY/BX	LIST PRICE
AES04016	1/4-28 x 1/2	100	
AES04020	1/4-28 x 5/8	100	
AES04024	1/4-28 x 3/4	100	
AES04028	1/4-28 x 7/8	100	
AES04032	1/4-28 x 1	100	
AES04040	1/4-28 x 1 1/4	100	
AES04044	1/4-28 x 1 3/8	100	
AES04048	1/4-28 x 1 1/2	100	
AES04056	1/4-28 x 1 3/4	100	
AES04064	1/4-28 x 2	100	
AES04072	1/4-28 x 2 1/4	50	
AES04080	1/4-28 x 2 1/2	50	
AES04088	1/4-28 x 2 3/4	50	
AES04096	1/4-28 x 3	50	
AES04104	1/4-28 x 3 1/4	50	
AES04112	1/4-28 x 3 1/2	50	
AES04120	1/4-28 x 3 3/4	50	
AES04128	1/4-28 x 4	50	
AES04144	1/4-28 x 4 1/2	25	
AES04160	1/4-28 x 5	50	
AES04176	1/4-28 x 5 1/2	50	
AES04192	1/4-28 x 6	50	
AES04208X	1/4-28 x 6 1/2	25	
AES04224	1/4-28 x 7	25	
AES05016	5/16-24 x 1/2	100	
AES05020	5/16-24 x 5/8	100	
AES05024	5/16-24 x 3/4	100	
AES05028	5/16-24 x 7/8	100	
AES05032	5/16-24 x 1	100	
AES05040	5/16-24 x 1 1/4	100	
AES05048	5/16-24 x 1 1/2	100	
AES05056	5/16-24 x 1 3/4	100	
AES05064	5/16-24 x 2	100	
AES05072	5/16-24 x 2 1/4	50	
AES05080	5/16-24 x 2 1/2	50	
AES05088	5/16-24 x 2 3/4	50	
AES05096	5/16-24 x 3	50	
AES05104	5/16-24 x 3 1/4	50	
AES05112	5/16-24 x 3 1/2	50	
AES05120	5/16-24 x 3 3/4	50	
AES05128	5/16-24 x 4	50	
AES05144	5/16-24 x 4 1/2	50	
AES05192	5/16-24 x 6	25	
AES05240	5/16-24 x 7 1/2	25	

(continued...)

**GRADE 5 HEX CAP SCREW (cont.)**

ZINC PLATED, UNF - MADE IN THE USA

Line: 144-00

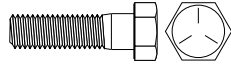

**GRADE 5 HEX CAP SCREW (cont.)**

ZINC PLATED, UNF - MADE IN THE USA

Line: 144-00

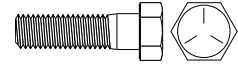

PAGE 3-16

CAP SCREWS - SECTION 03

PART NUMBER	SIZE	QTY/BX	LIST PRICE
AES06016	3/8-24 x 1/2	100	
AES06020	3/8-24 x 5/8	100	
AES06024	3/8-24 x 3/4	100	
AES06028	3/8-24 x 7/8	100	
AES06032	3/8-24 x 1	100	
AES06036	3/8-24 x 1 1/8	100	
AES06040	3/8-24 x 1 1/4	100	
AES06044	3/8-24 x 1 3/8	100	
AES06048	3/8-24 x 1 1/2	100	
AES06056	3/8-24 x 1 3/4	50	
AES06064	3/8-24 x 2	50	
AES06072	3/8-24 x 2 1/4	50	
AES06080	3/8-24 x 2 1/2	50	
AES06088	3/8-24 x 2 3/4	50	
AES06096	3/8-24 x 3	50	
AES06104	3/8-24 x 3 1/4	25	
AES06112	3/8-24 x 3 1/2	25	
AES06120	3/8-24 x 3 3/4	25	
AES06128	3/8-24 x 4	25	
AES06144	3/8-24 x 4 1/2	25	
AES06168	3/8-24 x 5 1/4	25	
AES06176	3/8-24 x 5 1/2	25	
AES06192	3/8-24 x 6	25	
AES06224	3/8-24 x 7	25	
AES06240	3/8-24 x 7 1/2	25	
AES06256	3/8-24 x 8	25	
AES07024	7/16-20 x 3/4	50	
AES07028	7/16-20 x 7/8	50	
AES07032	7/16-20 x 1	50	
AES07036	7/16-20 x 1 1/8	50	
AES07040	7/16-20 x 1 1/4	50	
AES07048	7/16-20 x 1 1/2	50	
AES07056	7/16-20 x 1 3/4	50	
AES07064	7/16-20 x 2	50	
AES07072	7/16-20 x 2 1/4	25	
AES07080	7/16-20 x 2 1/2	25	
AES07088	7/16-20 x 2 3/4	25	
AES07096	7/16-20 x 3	25	
AES07104	7/16-20 x 3 1/4	25	
AES07112	7/16-20 x 3 1/2	25	
AES07120	7/16-20 x 3 3/4	25	
AES07128	7/16-20 x 4	25	
AES07136	7/16-20 x 4 1/4	25	
AES07144	7/16-20 x 4 1/2	25	

(continued...)

PART NUMBER	SIZE	QTY/BX	LIST PRICE
AES07160	7/16-20 x 5	25	
AES07176	7/16-20 x 5 1/2	25	
AES07192	7/16-20 x 6	25	
AES07224	7/16-20 x 7	25	
AES07256	7/16-20 x 8	25	
AES08024	1/2-20 x 3/4	50	
AES08028	1/2-20 x 7/8	50	
AES08032	1/2-20 x 1	50	
AES08040	1/2-20 x 1 1/4	50	
AES08044	1/2-20 x 1 3/8	50	
AES08048	1/2-20 x 1 1/2	50	
AES08056	1/2-20 x 1 3/4	50	
AES08064	1/2-20 x 2	50	
AES08072	1/2-20 x 2 1/4	25	
AES08080	1/2-20 x 2 1/2	25	
AES08088	1/2-20 x 2 3/4	25	
AES08096	1/2-20 x 3	25	
AES08104	1/2-20 x 3 1/4	25	
AES08112	1/2-20 x 3 1/2	25	
AES08120	1/2-20 x 3 3/4	25	
AES08128	1/2-20 x 4	25	
AES08144	1/2-20 x 4 1/2	25	
AES08160	1/2-20 x 5	25	
AES08176	1/2-20 x 5 1/2	25	
AES08192	1/2-20 x 6	25	
AES08208	1/2-20 x 6 1/2	25	
AES08224	1/2-20 x 7	25	
AES08240	1/2-20 x 7 1/2	25	
AES08256	1/2-20 x 8	25	
AES10032	5/8-18 x 1	25	
AES10040	5/8-18 x 1 1/4	25	
AES10048	5/8-18 x 1 1/2	25	
AES10056	5/8-18 x 1 3/4	25	
AES10064	5/8-18 x 2	25	
AES10072	5/8-18 x 2 1/4	25	
AES10080	5/8-18 x 2 1/2	25	
AES10088	5/8-18 x 2 3/4	25	
AES10096	5/8-18 x 3	25	
AES10104	5/8-18 x 3 1/4	25	
AES10112	5/8-18 x 3 1/2	25	
AES10120	5/8-18 x 3 3/4	25	
AES10128	5/8-18 x 4	25	
AES10144	5/8-18 x 4 1/2	25	
AES10160	5/8-18 x 5	25	

(continued...)



**GRADE 5 HEX CAP SCREW (cont.)**

ZINC PLATED, UNF - MADE IN THE USA

Line: 144-00

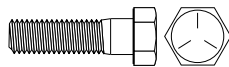

PART NUMBER	SIZE	QTY/BX	LIST PRICE
AES10176	5/8-18 x 5 1/2	25	
AES10192	5/8-18 x 6	25	
AES10208	5/8-18 x 6 1/2	25	
AES10224	5/8-18 x 7	25	
AES10240	5/8-18 x 7 1/2	25	
AES10256	5/8-18 x 8	25	
AES10272	5/8-18 x 8 1/2	10	
AES10288	5/8-18 x 9	10	
AES10304	5/8-18 x 9 1/2	10	
AES10320	5/8-18 x 10	10	
AES12032	3/4-16 x 1	25	
AES12040	3/4-16 x 1 1/4	25	
AES12048	3/4-16 x 1 1/2	25	
AES12056	3/4-16 x 1 3/4	25	
AES12064	3/4-16 x 2	25	
AES12072	3/4-16 x 2 1/4	25	
AES12080	3/4-16 x 2 1/2	25	
AES12088	3/4-16 x 2 3/4	25	
AES12096	3/4-16 x 3	25	
AES12104	3/4-16 x 3 1/4	25	
AES12112	3/4-16 x 3 1/2	25	
AES12120	3/4-16 x 3 3/4	25	
AES12128	3/4-16 x 4	25	
AES12144	3/4-16 x 4 1/2	10	
AES12160	3/4-16 x 5	10	
AES12176	3/4-16 x 5 1/2	10	
AES12192	3/4-16 x 6	10	
AES12208	3/4-16 x 6 1/2	10	
AES12224	3/4-16 x 7	10	
AES12240	3/4-16 x 7 1/2	10	
AES12256	3/4-16 x 8	10	
AES12272	3/4-16 x 8 1/2	10	
AES12288	3/4-16 x 9	10	
AES12304	3/4-16 x 9 1/2	10	
AES12320	3/4-16 x 10	10	
AES14048	7/8-14 x 1 1/2	15	
AES14056	7/8-14 x 1 3/4	15	
AES14064	7/8-14 x 2	15	
AES14072	7/8-14 x 2 1/4	15	
AES14080	7/8-14 x 2 1/2	15	
AES14088	7/8-14 x 2 3/4	15	
AES14096	7/8-14 x 3	15	
AES14104	7/8-14 x 3 1/4	15	
AES14112	7/8-14 x 3 1/2	15	

(continued...)

**GRADE 5 HEX CAP SCREW (cont.)**

ZINC PLATED, UNF - MADE IN THE USA

Line: 144-00

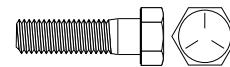

PART NUMBER	SIZE	QTY/BX	LIST PRICE
AES14120	7/8-14 x 3 3/4	15	
AES14128	7/8-14 x 4	15	
AES14144	7/8-14 x 4 1/2	10	
AES14160	7/8-14 x 5	10	
AES14176	7/8-14 x 5 1/2	10	
AES14192	7/8-14 x 6	10	
AES14208	7/8-14 x 6 1/2	10	
AES14224	7/8-14 x 7	10	
AES14240	7/8-14 x 7 1/2	10	
AES14256	7/8-14 x 8	10	
AES14272	7/8-14 x 8 1/2	10	
AES14288	7/8-14 x 9	10	
AES14304	7/8-14 x 9 1/2	10	
AES14320	7/8-14 x 10	10	
AES16048	1-14 x 1 1/2	10	
AES16056	1-14 x 1 3/4	10	
AES16064	1-14 x 2	10	
AES16072	1-14 x 2 1/4	10	
AES16080	1-14 x 2 1/2	10	
AES16088	1-14 x 2 3/4	10	
AES16096	1-14 x 3	10	
AES16104	1-14 x 3 1/4	10	
AES16112	1-14 x 3 1/2	10	
AES16120	1-14 x 3 3/4	10	
AES16128	1-14 x 4	10	
AES16144	1-14 x 4 1/2	10	
AES16160	1-14 x 5	10	
AES16176	1-14 x 5 1/2	10	
AES16192	1-14 x 6	10	
AES16208	1-14 x 6 1/2	10	
AES16224	1-14 x 7	10	
AES16256	1-14 x 8	5	
AES16272	1-14 x 8 1/2	5	
AES16288	1-14 x 9	5	
AES16304	1-14 x 9 1/2	5	
AES16320	1-14 x 10	5	
AES18096	1 1/8-12 x 3	5	
AES18112	1 1/8-12 x 3 1/2	5	
AES18128	1 1/8-12 x 4	5	
AES18144	1 1/8-12 x 4 1/2	5	
AES18160	1 1/8-12 x 5	5	
AES18176	1 1/8-12 x 5 1/2	5	
AES18192	1 1/8-12 x 6	5	
AES18208	1 1/8-12 x 6 1/2	5	

(continued...)

**GRADE 5 HEX CAP SCREW (cont.)**

ZINC PLATED, UNF - MADE IN THE USA

Line: 144-00

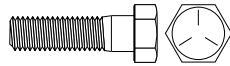

PART NUMBER	SIZE	QTY/BX	LIST PRICE
AES18224	1 1/8-12 x 7	5	
AES18256	1 1/8-12 x 8	5	
AES20080	1 1/4-12 x 2 1/2	5	
AES20096	1 1/4-12 x 3	5	
AES20112	1 1/4-12 x 3 1/2	5	
AES20128	1 1/4-12 x 4	5	
AES20144	1 1/4-12 x 4 1/2	5	
AES20160	1 1/4-12 x 5	5	
AES20176	1 1/4-12 x 5 1/2	5	
AES20192	1 1/4-12 x 6	5	
AES20208	1 1/4-12 x 6 1/2	5	
AES20224	1 1/4-12 x 7	5	
AES20240	1 1/4-12 x 7 1/2	5	
AES20256	1 1/4-12 x 8	5	
AES20272	1 1/4-12 x 8 1/2	5	
AES20288	1 1/4-12 x 9	5	
AES20320	1 1/4-12 x 10	5	

**GRADE 8 HEX CAP SCREW**

ZINC YELLOW, UNC - MADE IN THE USA

Line: 147-00

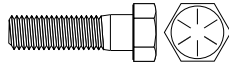

PART NUMBER	SIZE	QTY/BX	LIST PRICE
DAD04016	1/4-20 x 1/2	100	
DAD04020	1/4-20 x 5/8	100	
DAD04024	1/4-20 x 3/4	100	
DAD04028	1/4-20 x 7/8	100	
DAD04032	1/4-20 x 1	100	
DAD04040	1/4-20 x 1 1/4	100	
DAD04048	1/4-20 x 1 1/2	100	
DAD04056	1/4-20 x 1 3/4	100	
DAD04064	1/4-20 x 2	100	
DAD04072	1/4-20 x 2 1/4	50	
DAD04080	1/4-20 x 2 1/2	50	
DAD04088	1/4-20 x 2 3/4	50	
DAD04096	1/4-20 x 3	50	
DAD04104	1/4-20 x 3 1/4	50	
DAD04112	1/4-20 x 3 1/2	50	
DAD04120	1/4-20 x 3 3/4	50	
DAD04128	1/4-20 x 4	50	
DAD04144	1/4-20 x 4 1/2	50	
DAD04160	1/4-20 x 5	50	
DAD04176	1/4-20 x 5 1/2	50	
DAD04192	1/4-20 x 6	50	
DAD04208	1/4-20 x 6 1/2	25	
DAD04224	1/4-20 x 7	50	

(continued...)

**GRADE 8 HEX CAP SCREW (cont.)**

ZINC YELLOW, UNC - MADE IN THE USA

Line: 147-00

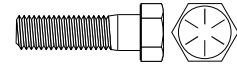

PART NUMBER	SIZE	QTY/BX	LIST PRICE
DAD04240	1/4-20 x 7 1/2	25	
DAD04256	1/4-20 x 8	25	
DAD05016	5/16-18 x 1/2	100	
DAD05020	5/16-18 x 5/8	100	
DAD05024	5/16-18 x 3/4	100	
DAD05028	5/16-18 x 7/8	100	
DAD05032	5/16-18 x 1	100	
DAD05036	5/16-18 x 1 1/8	100	
DAD05040	5/16-18 x 1 1/4	100	
DAD05048	5/16-18 x 1 1/2	100	
DAD05056	5/16-18 x 1 3/4	100	
DAD05064	5/16-18 x 2	100	
DAD05072	5/16-18 x 2 1/4	50	
DAD05080	5/16-18 x 2 1/2	50	
DAD05088	5/16-18 x 2 3/4	50	
DAD05096	5/16-18 x 3	50	
DAD05104	5/16-18 x 3 1/4	50	
DAD05112	5/16-18 x 3 1/2	50	
DAD05120	5/16-18 x 3 3/4	50	
DAD05128	5/16-18 x 4	50	
DAD05144	5/16-18 x 4 1/2	50	
DAD05160	5/16-18 x 5	50	
DAD05176	5/16-18 x 5 1/2	25	
DAD05192	5/16-18 x 6	25	
DAD05208	5/16-18 x 6 1/2	25	
DAD05240	5/16-18 x 7 1/2	25	
DAD05256	5/16-18 x 8	25	
DAD06016	3/8-16 x 1/2	100	
DAD06020	3/8-16 x 5/8	100	
DAD06024	3/8-16 x 3/4	100	
DAD06028	3/8-16 x 7/8	100	
DAD06032	3/8-16 x 1	100	
DAD06040	3/8-16 x 1 1/4	100	
DAD06048	3/8-16 x 1 1/2	100	
DAD06056	3/8-16 x 1 3/4	50	
DAD06064	3/8-16 x 2	50	
DAD06072	3/8-16 x 2 1/4	50	
DAD06080	3/8-16 x 2 1/2	50	
DAD06088	3/8-16 x 2 3/4	50	
DAD06096	3/8-16 x 3	50	
DAD06104	3/8-16 x 3 1/4	25	
DAD06112	3/8-16 x 3 1/2	25	
DAD06120	3/8-16 x 3 3/4	25	
DAD06128	3/8-16 x 4	25	

(continued...)

**GRADE 8 HEX CAP SCREW (cont.)**

ZINC YELLOW, UNC - MADE IN THE USA

Line: 147-00

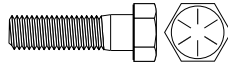

PART NUMBER	SIZE	QTY/BX	LIST PRICE
DAD06136	3/8-16 x 4 1/4	25	
DAD06144	3/8-16 x 4 1/2	25	
DAD06152	3/8-16 x 4 3/4	25	
DAD06160	3/8-16 x 5	25	
DAD06176	3/8-16 x 5 1/2	25	
DAD06192	3/8-16 x 6	25	
DAD06208	3/8-16 x 6 1/2	25	
DAD06224	3/8-16 x 7	25	
DAD06240	3/8-16 x 7 1/2	25	
DAD06256	3/8-16 x 8	25	
DAD07024	7/16-14 x 3/4	50	
DAD07028	7/16-14 x 7/8	50	
DAD07032	7/16-14 x 1	50	
DAD07040	7/16-14 x 1 1/4	50	
DAD07048	7/16-14 x 1 1/2	50	
DAD07056	7/16-14 x 1 3/4	50	
DAD07064	7/16-14 x 2	50	
DAD07072	7/16-14 x 2 1/4	25	
DAD07080	7/16-14 x 2 1/2	25	
DAD07088	7/16-14 x 2 3/4	25	
DAD07096	7/16-14 x 3	25	
DAD07104	7/16-14 x 3 1/4	25	
DAD07112	7/16-14 x 3 1/2	25	
DAD07120	7/16-14 x 3 3/4	25	
DAD07128	7/16-14 x 4	25	
DAD07144	7/16-14 x 4 1/2	25	
DAD07160	7/16-14 x 5	25	
DAD07176	7/16-14 x 5 1/2	25	
DAD07192	7/16-14 x 6	25	
DAD07208	7/16-14 x 6 1/2	25	
DAD07224	7/16-14 x 7	25	
DAD07240	7/16-14 x 7 1/2	25	
DAD07256	7/16-14 x 8	25	
DAD08024	1/2-13 x 3/4	50	
DAD08028	1/2-13 x 7/8	50	
DAD08032	1/2-13 x 1	50	
DAD08040	1/2-13 x 1 1/4	50	
DAD08048	1/2-13 x 1 1/2	50	
DAD08056	1/2-13 x 1 3/4	50	
DAD08064	1/2-13 x 2	50	
DAD08072	1/2-13 x 2 1/4	25	
DAD08080	1/2-13 x 2 1/2	25	
DAD08088	1/2-13 x 2 3/4	25	
DAD08096	1/2-13 x 3	25	

(continued...)

**GRADE 8 HEX CAP SCREW (cont.)**

ZINC YELLOW, UNC - MADE IN THE USA

Line: 147-00

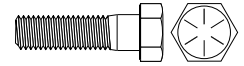

PART NUMBER	SIZE	QTY/BX	LIST PRICE
DAD08104	1/2-13 x 3 1/4	25	
DAD08112	1/2-13 x 3 1/2	25	
DAD08120	1/2-13 x 3 3/4	25	
DAD08128	1/2-13 x 4	25	
DAD08144	1/2-13 x 4 1/2	25	
DAD08152	1/2-13 x 4 3/4	25	
DAD08160	1/2-13 x 5	25	
DAD08176	1/2-13 x 5 1/2	25	
DAD08192	1/2-13 x 6	25	
DAD08208	1/2-13 x 6 1/2	25	
DAD08224	1/2-13 x 7	25	
DAD08240	1/2-13 x 7 1/2	25	
DAD08256	1/2-13 x 8	25	
DAD09032	9/16-12 x 1	25	
DAD09040	9/16-12 x 1 1/4	25	
DAD09048	9/16-12 x 1 1/2	25	
DAD09056	9/16-12 x 1 3/4	25	
DAD09064	9/16-12 x 2	25	
DAD09072	9/16-12 x 2 1/4	25	
DAD09080	9/16-12 x 2 1/2	25	
DAD09088	9/16-12 x 2 3/4	25	
DAD09096	9/16-12 x 3	25	
DAD09104	9/16-12 x 3 1/4	25	
DAD09112	9/16-12 x 3 1/2	25	
DAD09120	9/16-12 x 3 3/4	25	
DAD09128	9/16-12 x 4	25	
DAD09144	9/16-12 x 4 1/2	25	
DAD09160	9/16-12 x 5	25	
DAD09176	9/16-12 x 5 1/2	25	
DAD09192	9/16-12 x 6	25	
DAD09208	9/16-12 x 6 1/2	25	
DAD09224	9/16-12 x 7	25	
DAD09240	9/16-12 x 7 1/2	25	
DAD09256	9/16-12 x 8	25	
DAD10032	5/8-11 x 1	25	
DAD10040	5/8-11 x 1 1/4	25	
DAD10048	5/8-11 x 1 1/2	25	
DAD10056	5/8-11 x 1 3/4	25	
DAD10064	5/8-11 x 2	25	
DAD10072	5/8-11 x 2 1/4	25	
DAD10080	5/8-11 x 2 1/2	25	
DAD10088	5/8-11 x 2 3/4	25	
DAD10096	5/8-11 x 3	25	
DAD10104	5/8-11 x 3 1/4	25	

(continued...)

**GRADE 8 HEX CAP SCREW (cont.)**

ZINC YELLOW, UNC - MADE IN THE USA

Line: 147-00

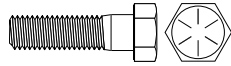

PART NUMBER	SIZE	QTY/BX	LIST PRICE
DAD10112	5/8-11 x 3 1/2	25	
DAD10120	5/8-11 x 3 3/4	25	
DAD10128	5/8-11 x 4	25	
DAD10144	5/8-11 x 4 1/2	25	
DAD10152	5/8-11 x 4 3/4	25	
DAD10160	5/8-11 x 5	25	
DAD10176	5/8-11 x 5 1/2	25	
DAD10192	5/8-11 x 6	25	
DAD10208	5/8-11 x 6 1/2	25	
DAD10224	5/8-11 x 7	25	
DAD10240	5/8-11 x 7 1/2	25	
DAD10256	5/8-11 x 8	25	
DAD10272	5/8-11 x 8 1/2	25	
DAD10288	5/8-11 x 9	25	
DAD10320	5/8-11 x 10	10	
DAD12032	3/4-10 x 1	25	
DAD12040	3/4-10 x 1 1/4	25	
DAD12048	3/4-10 x 1 1/2	25	
DAD12056	3/4-10 x 1 3/4	25	
DAD12064	3/4-10 x 2	25	
DAD12072	3/4-10 x 2 1/4	25	
DAD12080	3/4-10 x 2 1/2	25	
DAD12088	3/4-10 x 2 3/4	25	
DAD12096	3/4-10 x 3	25	
DAD12104	3/4-10 x 3 1/4	25	
DAD12112	3/4-10 x 3 1/2	25	
DAD12128	3/4-10 x 4	25	
DAD12136X	3/4-10 x 4 1/4	10	
DAD12144	3/4-10 x 4 1/2	10	
DAD12160	3/4-10 x 5	10	
DAD12176	3/4-10 x 5 1/2	10	
DAD12192	3/4-10 x 6	10	
DAD12208	3/4-10 x 6 1/2	10	
DAD12224	3/4-10 x 7	10	
DAD12240	3/4-10 x 7 1/2	10	
DAD12256	3/4-10 x 8	10	
DAD12272	3/4-10 x 8 1/2	10	
DAD12288	3/4-10 x 9	10	
DAD12304	3/4-10 x 9 1/2	10	
DAD12320	3/4-10 x 10	10	
DAD14048	7/8-9 x 1 1/2	15	
DAD14056	7/8-9 x 1 3/4	15	
DAD14064	7/8-9 x 2	15	
DAD14072	7/8-9 x 2 1/4	15	

(continued...)

**GRADE 8 HEX CAP SCREW (cont.)**

ZINC YELLOW, UNC - MADE IN THE USA

Line: 147-00

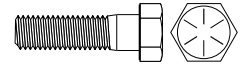

PART NUMBER	SIZE	QTY/BX	LIST PRICE
DAD14080	7/8-9 x 2 1/2	15	
DAD14088	7/8-9 x 2 3/4	15	
DAD14096	7/8-9 x 3	15	
DAD14104	7/8-9 x 3 1/4	15	
DAD14112	7/8-9 x 3 1/2	15	
DAD14120	7/8-9 x 3 3/4	15	
DAD14128	7/8-9 x 4	15	
DAD14144	7/8-9 x 4 1/2	10	
DAD14160	7/8-9 x 5	10	
DAD14176	7/8-9 x 5 1/2	10	
DAD14192	7/8-9 x 6	10	
DAD14208	7/8-9 x 6 1/2	10	
DAD14224	7/8-9 x 7	10	
DAD14240	7/8-9 x 7 1/2	10	
DAD14256	7/8-9 x 8	10	
DAD14272	7/8-9 x 8 1/2	10	
DAD14288	7/8-9 x 9	10	
DAD14304	7/8-9 x 9 1/2	10	
DAD14320	7/8-9 x 10	10	
DAD16048	1-8 x 1 1/2	10	
DAD16056	1-8 x 1 3/4	10	
DAD16064	1-8 x 2	10	
DAD16072	1-8 x 2 1/4	10	
DAD16080	1-8 x 2 1/2	10	
DAD16088	1-8 x 2 3/4	10	
DAD16096	1-8 x 3	10	
DAD16104	1-8 x 3 1/4	10	
DAD16112	1-8 x 3 1/2	10	
DAD16128	1-8 x 4	10	
DAD16136	1-8 x 4 1/4	10	
DAD16144	1-8 x 4 1/2	10	
DAD16160	1-8 x 5	10	
DAD16176	1-8 x 5 1/2	10	
DAD16192	1-8 x 6	10	
DAD16208	1-8 x 6 1/2	10	
DAD16224	1-8 x 7	10	
DAD16240	1-8 x 7 1/2	5	
DAD16256	1-8 x 8	5	
DAD16272	1-8 x 8 1/2	5	
DAD16288	1-8 x 9	5	
DAD16304	1-8 x 9 1/2	5	
DAD16320	1-8 x 10	5	
DAD18064	1 1/8-7 x 2	5	
DAD18072	1 1/8-7 x 2 1/4	5	

(continued...)

**GRADE 8 HEX CAP SCREW (cont.)**ZINC YELLOW, UNC - **MADE IN THE USA**

Line: 147-00

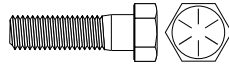

PART NUMBER	SIZE	QTY/BX	LIST PRICE
DAD18080	1 1/8-7 x 2 1/2	5	
DAD18088	1 1/8-7 x 2 3/4	5	
DAD18096	1 1/8-7 x 3	5	
DAD18104	1 1/8-7 x 3 1/4	5	
DAD18112	1 1/8-7 x 3 1/2	5	
DAD18120	1 1/8-7 x 3 3/4	5	
DAD18128	1 1/8-7 x 4	5	
DAD18144	1 1/8-7 x 4 1/2	5	
DAD18160	1 1/8-7 x 5	5	
DAD18176	1 1/8-7 x 5 1/2	5	
DAD18192	1 1/8-7 x 6	5	
DAD18208	1 1/8-7 x 6 1/2	5	
DAD18224	1 1/8-7 x 7	5	
DAD18240	1 1/8-7 x 7 1/2	5	
DAD18256	1 1/8-7 x 8	5	
DAD18272	1 1/8-7 x 8 1/2	5	
DAD18288	1 1/8-7 x 9	5	
DAD18304	1 1/8-7 x 9 1/2	5	
DAD18320	1 1/8-7 x 10	5	
DAD20064	1 1/4-7 x 2	5	
DAD20072	1 1/4-7 x 2 1/4	5	
DAD20080	1 1/4-7 x 2 1/2	5	
DAD20088	1 1/4-7 x 2 3/4	5	
DAD20096	1 1/4-7 x 3	5	
DAD20104	1 1/4-7 x 3 1/4	5	
DAD20112	1 1/4-7 x 3 1/2	5	
DAD20120	1 1/4-7 x 3 3/4	5	
DAD20128	1 1/4-7 x 4	5	
DAD20144	1 1/4-7 x 4 1/2	5	
DAD20160	1 1/4-7 x 5	5	
DAD20176	1 1/4-7 x 5 1/2	5	
DAD20192	1 1/4-7 x 6	5	
DAD20208	1 1/4-7 x 6 1/2	5	
DAD20224	1 1/4-7 x 7	5	
DAD20240	1 1/4-7 x 7 1/2	5	
DAD20256	1 1/4-7 x 8	5	
DAD20272	1 1/4-7 x 8 1/2	5	
DAD20288	1 1/4-7 x 9	5	
DAD20304	1 1/4-7 x 9 1/2	5	
DAD20320	1 1/4-7 x 10	5	

**GRADE 8 HEX CAP SCREW**ZINC YELLOW, UNF - **MADE IN THE USA**

Line: 148-00

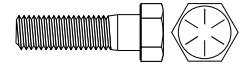

PART NUMBER	SIZE	QTY/BX	LIST PRICE
DBD04016	1/4-28 x 1/2	100	
DBD04020	1/4-28 x 5/8	100	
DBD04024	1/4-28 x 3/4	100	
DBD04028	1/4-28 x 7/8	100	
DBD04032	1/4-28 x 1 (USA)	100	
DBD04040	1/4-28 x 1 1/4	100	
DBD04048	1/4-28 x 1 1/2	100	
DBD04056	1/4-28 x 1 3/4	100	
DBD04064	1/4-28 x 2	100	
DBD04072	1/4-28 x 2 1/4	50	
DBD04080	1/4-28 x 2 1/2	50	
DBD04088	1/4-28 x 2 3/4	50	
DBD04096	1/4-28 x 3	50	
DBD04104	1/4-28 x 3 1/4	50	
DBD04112	1/4-28 x 3 1/2	50	
DBD04120	1/4-28 x 3 3/4	50	
DBD04128	1/4-28 x 4	50	
DBD04144	1/4-28 x 4 1/2	50	
DBD04160	1/4-28 x 5	50	
DBD04176	1/4-28 x 5 1/2	50	
DBD04192	1/4-28 x 6	50	
DBD04208	1/4-28 x 6 1/2	25	
DBD04224	1/4-28 x 7	25	
DBD04240	1/4-28 x 7 1/2	25	
DBD04256	1/4-28 x 8	25	
DBD05016	5/16-24 x 1/2	100	
DBD05020	5/16-24 x 5/8	100	
DBD05024	5/16-24 x 3/4	100	
DBD05028	5/16-24 x 7/8	100	
DBD05032	5/16-24 x 1	100	
DBD05040	5/16-24 x 1 1/4	100	
DBD05048	5/16-24 x 1 1/2	100	
DBD05056	5/16-24 x 1 3/4	100	
DBD05064	5/16-24 x 2	100	
DBD05072	5/16-24 x 2 1/4	50	
DBD05080	5/16-24 x 2 1/2	50	
DBD05088	5/16-24 x 2 3/4	50	
DBD05096	5/16-24 x 3	50	
DBD05104	5/16-24 x 3 1/4	50	
DBD05112	5/16-24 x 3 1/2	50	
DBD05120	5/16-24 x 3 3/4	50	
DBD05128	5/16-24 x 4	50	
DBD05144	5/16-24 x 4 1/2	50	
DBD05160	5/16-24 x 5	25	

(continued...)

**GRADE 8 HEX CAP SCREW (cont.)**

ZINC YELLOW, UNF - MADE IN THE USA

Line: 148-00

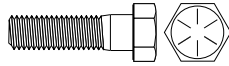
**GRADE 8 HEX CAP SCREW (cont.)**

ZINC YELLOW, UNF - MADE IN THE USA

Line: 148-00

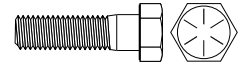

PAGE 3-22

CAP SCREWS - SECTION 03

PART NUMBER	SIZE	QTY/BX	LIST PRICE
DBD05176	5/16-24 x 5 1/2	25	
DBD05192	5/16-24 x 6	25	
DBD05208	5/16-24 x 6 1/2	25	
DBD05224	5/16-24 x 7	25	
DBD05240	5/16-24 x 7 1/2	25	
DBD05256	5/16-24 x 8	25	
DBD06016	3/8-24 x 1/2	100	
DBD06020	3/8-24 x 5/8	100	
DBD06024	3/8-24 x 3/4	100	
DBD06028	3/8-24 x 7/8	100	
DBD06032	3/8-24 x 1	100	
DBD06040	3/8-24 x 1 1/4	100	
DBD06048	3/8-24 x 1 1/2	100	
DBD06056	3/8-24 x 1 3/4	50	
DBD06064	3/8-24 x 2	50	
DBD06072	3/8-24 x 2 1/4	50	
DBD06080	3/8-24 x 2 1/2	50	
DBD06088	3/8-24 x 2 3/4	50	
DBD06096	3/8-24 x 3	50	
DBD06104	3/8-24 x 3 1/4	25	
DBD06112	3/8-24 x 3 1/2	25	
DBD06120	3/8-24 x 3 3/4	25	
DBD06128	3/8-24 x 4	25	
DBD06144	3/8-24 x 4 1/2	25	
DBD06152	3/8-24 x 4 3/4	25	
DBD06160	3/8-24 x 5	25	
DBD06176	3/8-24 x 5 1/2	25	
DBD06192	3/8-24 x 6	25	
DBD06208	3/8-24 x 6 1/2	25	
DBD06224	3/8-24 x 7	25	
DBD06240	3/8-24 x 7 1/2	25	
DBD06256	3/8-24 x 8	25	
DBD07024	7/16-20 x 3/4	50	
DBD07028	7/16-20 x 7/8	50	
DBD07032	7/16-20 x 1	50	
DBD07040	7/16-20 x 1 1/4	50	
DBD07048	7/16-20 x 1 1/2	50	
DBD07056	7/16-20 x 1 3/4	50	
DBD07064	7/16-20 x 2	50	
DBD07072	7/16-20 x 2 1/4	25	
DBD07080	7/16-20 x 2 1/2	25	
DBD07088	7/16-20 x 2 3/4	25	
DBD07096	7/16-20 x 3	25	
DBD07104	7/16-20 x 3 1/4	25	

(continued...)

PART NUMBER	SIZE	QTY/BX	LIST PRICE
DBD07112	7/16-20 x 3 1/2	25	
DBD07120	7/16-20 x 3 3/4	25	
DBD07128	7/16-20 x 4	25	
DBD07144	7/16-20 x 4 1/2	25	
DBD07160	7/16-20 x 5	25	
DBD07176	7/16-20 x 5 1/2	25	
DBD07192	7/16-20 x 6	25	
DBD07208	7/16-20 x 6 1/2	25	
DBD07224	7/16-20 x 7	25	
DBD07240	7/16-20 x 7 1/2	25	
DBD07256	7/16-20 x 8	25	
DBD08024	1/2-20 x 3/4	50	
DBD08028	1/2-20 x 7/8	50	
DBD08032	1/2-20 x 1	50	
DBD08040	1/2-20 x 1 1/4	50	
DBD08044	1/2-20 x 1 3/8	50	
DBD08048	1/2-20 x 1 1/2	50	
DBD08056	1/2-20 x 1 3/4	50	
DBD08064	1/2-20 x 2	50	
DBD08072	1/2-20 x 2 1/4	25	
DBD08080	1/2-20 x 2 1/2	25	
DBD08088	1/2-20 x 2 3/4	25	
DBD08096	1/2-20 x 3	25	
DBD08104	1/2-20 x 3 1/4	25	
DBD08112	1/2-20 x 3 1/2	25	
DBD08120	1/2-20 x 3 3/4	25	
DBD08128	1/2-20 x 4	25	
DBD08144	1/2-20 x 4 1/2	25	
DBD08160	1/2-20 x 5	25	
DBD08176	1/2-20 x 5 1/2	25	
DBD08192	1/2-20 x 6	25	
DBD08208	1/2-20 x 6 1/2	25	
DBD08224	1/2-20 x 7	25	
DBD08240	1/2-20 x 7 1/2	25	
DBD08256	1/2-20 x 8	25	
DBD09032	9/16-18 x 1	25	
DBD09040	9/16-18 x 1 1/4	25	
DBD09048	9/16-18 x 1 1/2	25	
DBD09056	9/16-18 x 1 3/4	25	
DBD09064	9/16-18 x 2	25	
DBD09072	9/16-18 x 2 1/4	25	
DBD09080	9/16-18 x 2 1/2	25	
DBD09088	9/16-18 x 2 3/4	25	
DBD09096	9/16-18 x 3	25	

(continued...)

**GRADE 8 HEX CAP SCREW (cont.)**

ZINC YELLOW, UNF - MADE IN THE USA

Line: 148-00

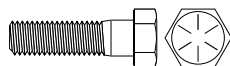

PART NUMBER	SIZE	QTY/BX	LIST PRICE
DBD09104	9/16-18 x 3 1/4	25	
DBD09112	9/16-18 x 3 1/2	25	
DBD09120	9/16-18 x 3 3/4	25	
DBD09128	9/16-18 x 4	25	
DBD09144	9/16-18 x 4 1/2	25	
DBD09160	9/16-18 x 5	25	
DBD09176	9/16-18 x 5 1/2	25	
DBD09192	9/16-18 x 6	25	
DBD09208	9/16-18 x 6 1/2	25	
DBD09224	9/16-18 x 7	25	
DBD09240	9/16-18 x 7 1/2	25	
DBD09256	9/16-18 x 8	25	
DBD10032	5/8-18 x 1	25	
DBD10040	5/8-18 x 1 1/4	25	
DBD10048	5/8-18 x 1 1/2	25	
DBD10056	5/8-18 x 1 3/4	25	
DBD10064	5/8-18 x 2	25	
DBD10072	5/8-18 x 2 1/4	25	
DBD10080	5/8-18 x 2 1/2	25	
DBD10088	5/8-18 x 2 3/4	25	
DBD10096	5/8-18 x 3	25	
DBD10104	5/8-18 x 3 1/4	25	
DBD10112	5/8-18 x 3 1/2	25	
DBD10120	5/8-18 x 3 3/4	25	
DBD10128	5/8-18 x 4	25	
DBD10144	5/8-18 x 4 1/2	25	
DBD10160	5/8-18 x 5	25	
DBD10176	5/8-18 x 5 1/2	25	
DBD10184X	5/8-18 x 5 3/4	25	
DBD10192	5/8-18 x 6	25	
DBD10208	5/8-18 x 6 1/2	25	
DBD10224	5/8-18 x 7	25	
DBD10240	5/8-18 x 7 1/2	25	
DBD10256	5/8-18 x 8	25	
DBD10272	5/8-18 x 8 1/2	25	
DBD10288	5/8-18 x 9	25	
DBD10320	5/8-18 x 10	10	
DBD12032	3/4-16 x 1	25	
DBD12040	3/4-16 x 1 1/4	25	
DBD12048	3/4-16 x 1 1/2	25	
DBD12056	3/4-16 x 1 3/4	25	
DBD12064	3/4-16 x 2	25	
DBD12072	3/4-16 x 2 1/4	25	
DBD12080	3/4-16 x 2 1/2	25	

(continued...)

**GRADE 8 HEX CAP SCREW (cont.)**

ZINC YELLOW, UNF - MADE IN THE USA

Line: 148-00

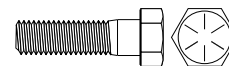

PART NUMBER	SIZE	QTY/BX	LIST PRICE
DBD12088	3/4-16 x 2 3/4	25	
DBD12096	3/4-16 x 3	25	
DBD12104	3/4-16 x 3 1/4	25	
DBD12112	3/4-16 x 3 1/2	25	
DBD12120	3/4-16 x 3 3/4	25	
DBD12128	3/4-16 x 4	25	
DBD12144	3/4-16 x 4 1/2	10	
DBD12160	3/4-16 x 5	10	
DBD12176	3/4-16 x 5 1/2	10	
DBD12192	3/4-16 x 6	10	
DBD12208	3/4-16 x 6 1/2	10	
DBD12224	3/4-16 x 7	10	
DBD12240	3/4-16 x 7 1/2	10	
DBD12256	3/4-16 x 8	10	
DBD12272	3/4-16 x 8 1/2	10	
DBD12288	3/4-16 x 9	10	
DBD12304	3/4-16 x 9 1/2	10	
DBD12320	3/4-16 x 10	10	
DBD14048	7/8-14 x 1 1/2	15	
DBD14056	7/8-14 x 1 3/4	15	
DBD14064	7/8-14 x 2	15	
DBD14072	7/8-14 x 2 1/4	15	
DBD14080	7/8-14 x 2 1/2	15	
DBD14088	7/8-14 x 2 3/4	15	
DBD14096	7/8-14 x 3	15	
DBD14104	7/8-14 x 3 1/4	15	
DBD14112	7/8-14 x 3 1/2	15	
DBD14120	7/8-14 x 3 3/4	15	
DBD14128	7/8-14 x 4	15	
DBD14144	7/8-14 x 4 1/2	10	
DBD14160	7/8-14 x 5	10	
DBD14176	7/8-14 x 5 1/2	10	
DBD14192	7/8-14 x 6	10	
DBD14208	7/8-14 x 6 1/2	10	
DBD14224	7/8-14 x 7	10	
DBD14240	7/8-14 x 7 1/2	10	
DBD14256	7/8-14 x 8	10	
DBD14272	7/8-14 x 8 1/2	10	
DBD14288	7/8-14 x 9	10	
DBD14304	7/8-14 x 9 1/2	10	
DBD14320	7/8-14 x 10	10	
DBD16048	1-14 x 1 1/2	10	
DBD16056	1-14 x 1 3/4	10	
DBD16064	1-14 x 2	10	

(continued...)

**GRADE 8 HEX CAP SCREW (cont.)**

ZINC YELLOW, UNF - MADE IN THE USA

Line: 148-00

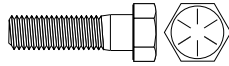

PART NUMBER	SIZE	QTY/BX	LIST PRICE
DBD16072	1-14 x 2 1/4	10	
DBD16080	1-14 x 2 1/2	10	
DBD16088	1-14 x 2 3/4	10	
DBD16096	1-14 x 3	10	
DBD16104	1-14 x 3 1/4	10	
DBD16112	1-14 x 3 1/2	10	
DBD16120	1-14 x 3 3/4	10	
DBD16128	1-14 x 4	10	
DBD16144	1-14 x 4 1/2	10	
DBD16160	1-14 x 5	10	
DBD16176	1-14 x 5 1/2	10	
DBD16192	1-14 x 6	10	
DBD16208	1-14 x 6 1/2	10	
DBD16224	1-14 x 7	10	
DBD16240	1-14 x 7 1/2	10	
DBD16256	1-14 x 8	5	
DBD16272	1-14 x 8 1/2	5	
DBD16288	1-14 x 9	5	
DBD16304	1-14 x 9 1/2	5	
DBD16320	1-14 x 10	5	
DBD18064	1 1/8-12 x 2	5	
DBD18072	1 1/8-12 x 2 1/4	5	
DBD18080	1 1/8-12 x 2 1/2	5	
DBD18088	1 1/8-12 x 2 3/4	5	
DBD18096	1 1/8-12 x 3	5	
DBD18104	1 1/8-12 x 3 1/4	5	
DBD18112	1 1/8-12 x 3 1/2	5	
DBD18120	1 1/8-12 x 3 3/4	5	
DBD18128	1 1/8-12 x 4	5	
DBD18144	1 1/8-12 x 4 1/2	5	
DBD18160	1 1/8-12 x 5	5	
DBD18176	1 1/8-12 x 5 1/2	5	
DBD18192	1 1/8-12 x 6	5	
DBD18208	1 1/8-12 x 6 1/2	5	
DBD18224	1 1/8-12 x 7	5	
DBD18240	1 1/8-12 x 7 1/2	5	
DBD18256	1 1/8-12 x 8	5	
DBD18272	1 1/8-12 x 8 1/2	5	
DBD18288	1 1/8-12 x 9	5	
DBD18304	1 1/8-12 x 9 1/2	5	
DBD18320	1 1/8-12 x 10	5	
DBD20064	1 1/4-12 x 2	5	
DBD20072	1 1/4-12 x 2 1/4	5	
DBD20080	1 1/4-12 x 2 1/2	5	

(continued...)

**GRADE 8 HEX CAP SCREW (cont.)**

ZINC YELLOW, UNF - MADE IN THE USA

Line: 148-00

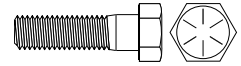

PART NUMBER	SIZE	QTY/BX	LIST PRICE
DBD20088	1 1/4-12 x 2 3/4	5	
DBD20096	1 1/4-12 x 3	5	
DBD20104	1 1/4-12 x 3 1/4	5	
DBD20112	1 1/4-12 x 3 1/2	5	
DBD20120	1 1/4-12 x 3 3/4	5	
DBD20128	1 1/4-12 x 4	5	
DBD20144	1 1/4-12 x 4 1/2	5	
DBD20160	1 1/4-12 x 5	5	
DBD20176	1 1/4-12 x 5 1/2	5	
DBD20192	1 1/4-12 x 6	5	
DBD20208	1 1/4-12 x 6 1/2	5	
DBD20224	1 1/4-12 x 7	5	
DBD20240	1 1/4-12 x 7 1/2	5	
DBD20256	1 1/4-12 x 8	5	
DBD20272	1 1/4-12 x 8 1/2	1	
DBD20288	1 1/4-12 x 9	5	
DBD20304	1 1/4-12 x 9 1/2	1	
DBD20320	1 1/4-12 x 10	5	

**GRADE 5 HEX CAP SCREW**

ZINC PLATED, UNC - NORTH AMERICAN

Line: 148-01

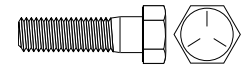

PART NUMBER	SIZE	QTY/BX	LIST PRICE
JJM04012	1/4-20 x 3/8	100	
JJM04016	1/4-20 x 1/2	100	
JJM04020	1/4-20 x 5/8	100	
JJM04024	1/4-20 x 3/4	100	
JJM04028	1/4-20 x 7/8	100	
JJM04032	1/4-20 x 1	100	
JJM04040	1/4-20 x 1 1/4	100	
JJM04048	1/4-20 x 1 1/2	100	
JJM04056	1/4-20 x 1 3/4	100	
JJM04064	1/4-20 x 2	100	
JJM04072	1/4-20 x 2 1/4	50	
JJM04080	1/4-20 x 2 1/2	50	
JJM04088	1/4-20 x 2 3/4	50	
JJM04096	1/4-20 x 3	50	
JJM04104	1/4-20 x 3 1/4	50	
JJM04112	1/4-20 x 3 1/2	50	
JJM04120	1/4-20 x 3 3/4	50	
JJM04128	1/4-20 x 4	50	
JJM04144	1/4-20 x 4 1/2	50	
JJM04160	1/4-20 x 5	50	
JJM04176	1/4-20 x 5 1/2	50	
JJM04192	1/4-20 x 6	50	

(continued...)



**GRADE 5 HEX CAP SCREW (cont.)**

ZINC PLATED, UNC - NORTH AMERICAN

Line: 148-01

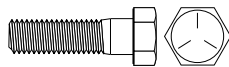

PART NUMBER	SIZE	QTY/BX	LIST PRICE
JJM04208	1/4-20 x 6 1/2	25	
JJM04224	1/4-20 x 7	25	
JJM04240	1/4-20 x 7 1/2	25	
JJM04256	1/4-20 x 8	25	
JJM05016	5/16-18 x 1/2	100	
JJM05020	5/16-18 x 5/8	100	
JJM05024	5/16-18 x 3/4	100	
JJM05028	5/16-18 x 7/8	100	
JJM05032	5/16-18 x 1	100	
JJM05040	5/16-18 x 1 1/4	100	
JJM05044	5/16-18 x 1 3/8	100	
JJM05048	5/16-18 x 1 1/2	100	
JJM05056	5/16-18 x 1 3/4	100	
JJM05064	5/16-18 x 2	100	
JJM05072X	5/16-18 x 2 1/4	50	
JJM05080	5/16-18 x 2 1/2	50	
JJM05088X	5/16-18 x 2 3/4	50	
JJM05096	5/16-18 x 3	50	
JJM05104X	5/16-18 x 3 1/4	50	
JJM05112	5/16-18 x 3 1/2	50	
JJM05120	5/16-18 x 3 3/4	50	
JJM05128	5/16-18 x 4	50	
JJM05144	5/16-18 x 4 1/2	50	
JJM05160	5/16-18 x 5	50	
JJM05176	5/16-18 x 5 1/2	25	
JJM05192	5/16-18 x 6	25	
JJM05208	5/16-18 x 6 1/2	25	
JJM05224	5/16-18 x 7	25	
JJM05240	5/16-18 x 7 1/2	25	
JJM05256	5/16-18 x 8	25	
JJM06016	3/8-16 x 1/2	100	
JJM06020	3/8-16 x 5/8	100	
JJM06024	3/8-16 x 3/4	100	
JJM06028	3/8-16 x 7/8	100	
JJM06032	3/8-16 x 1	100	
JJM06040	3/8-16 x 1 1/4	100	
JJM06048	3/8-16 x 1 1/2	100	
JJM06056	3/8-16 x 1 3/4	50	
JJM06064	3/8-16 x 2	50	
JJM06072	3/8-16 x 2 1/4	50	
JJM06080	3/8-16 x 2 1/2	50	
JJM06088	3/8-16 x 2 3/4	50	
JJM06096	3/8-16 x 3	50	
JJM06104	3/8-16 x 3 1/4	25	

(continued...)

**GRADE 5 HEX CAP SCREW (cont.)**

ZINC PLATED, UNC - NORTH AMERICAN

Line: 148-01

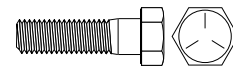

PART NUMBER	SIZE	QTY/BX	LIST PRICE
JJM10120	5/8-11 x 3 3/4	25	
JJM10128	5/8-11 x 4	25	
JJM10144	5/8-11 x 4 1/2	25	
JJM10160	5/8-11 x 5	25	
JJM10176	5/8-11 x 5 1/2	25	
JJM10192	5/8-11 x 6	25	
JJM10208	5/8-11 x 6 1/2	25	
JJM10224	5/8-11 x 7	25	
JJM10240	5/8-11 x 7 1/2	25	
JJM10256	5/8-11 x 8	25	
JJM10272	5/8-11 x 8 1/2	10	
JJM10288	5/8-11 x 9	25	
JJM10320	5/8-11 x 10	10	
JJM10352	5/8-11 x 11	10	
JJM10384	5/8-11 x 12	10	
JJM12032	3/4-10 x 1	25	
JJM12040X	3/4-10 x 1 1/4	25	
JJM12048	3/4-10 x 1 1/2	25	
JJM12056	3/4-10 x 1 3/4	25	
JJM12064	3/4-10 x 2	25	
JJM12072	3/4-10 x 2 1/4	25	
JJM12080	3/4-10 x 2 1/2	25	
JJM12088	3/4-10 x 2 3/4	25	
JJM12096	3/4-10 x 3	25	
JJM12104	3/4-10 x 3 1/4	25	
JJM12112	3/4-10 x 3 1/2	25	
JJM12120	3/4-10 x 3 3/4	25	
JJM12128	3/4-10 x 4	25	
JJM12144	3/4-10 x 4 1/2	10	
JJM12160	3/4-10 x 5	10	
JJM12176	3/4-10 x 5 1/2	10	
JJM12192	3/4-10 x 6	10	
JJM12208	3/4-10 x 6 1/2	10	
JJM12224	3/4-10 x 7	10	
JJM12240	3/4-10 x 7 1/2	10	
JJM12256	3/4-10 x 8	10	
JJM12272	3/4-10 x 8 1/2	10	
JJM12288	3/4-10 x 9	10	
JJM12304	3/4-10 x 9 1/2	10	
JJM12320	3/4-10 x 10	10	
JJM12384	3/4-10 x 12	10	
JJM14048	7/8-9 x 1 1/2	15	
JJM14056	7/8-9 x 1 3/4	15	
JJM14064	7/8-9 x 2	15	

(continued...)

**GRADE 5 HEX CAP SCREW (cont.)**

ZINC PLATED, UNC - NORTH AMERICAN

Line: 148-01

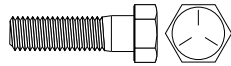

**GRADE 5 HEX CAP SCREW (cont.)**

ZINC PLATED, UNC - NORTH AMERICAN

Line: 148-01

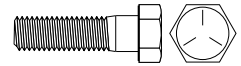

PAGE 3-26

CAP SCREWS - SECTION 03

PART NUMBER	SIZE	QTY/BX	LIST PRICE
JJM06112	3/8-16 x 3 1/2	25	
JJM06120	3/8-16 x 3 3/4	25	
JJM06128	3/8-16 x 4	25	
JJM06144	3/8-16 x 4 1/2	25	
JJM06160	3/8-16 x 5	25	
JJM06176	3/8-16 x 5 1/2	25	
JJM06192	3/8-16 x 6	25	
JJM06208	3/8-16 x 6 1/2	25	
JJM06224	3/8-16 x 7	25	
JJM06240	3/8-16 x 7 1/2	25	
JJM06256	3/8-16 x 8	25	
JJM07024	7/16-14 x 3/4	50	
JJM07028	7/16-14 x 7/8	50	
JJM07032	7/16-14 x 1	50	
JJM07040	7/16-14 x 1 1/4	50	
JJM07048	7/16-14 x 1 1/2	50	
JJM07056X	7/16-14 x 1 3/4	50	
JJM07064	7/16-14 x 2	50	
JJM07072X	7/16-14 x 2 1/4	25	
JJM07080	7/16-14 x 2 1/2	25	
JJM07088X	7/16-14 x 2 3/4	25	
JJM07096	7/16-14 x 3	25	
JJM07104	7/16-14 x 3 1/4	25	
JJM07112X	7/16-14 x 3 1/2	25	
JJM07120	7/16-14 x 3 3/4	25	
JJM07128X	7/16-14 x 4	25	
JJM07144	7/16-14 x 4 1/2	25	
JJM07160	7/16-14 x 5	25	
JJM07176	7/16-14 x 5 1/2	25	
JJM07192	7/16-14 x 6	25	
JJM07208	7/16-14 x 6 1/2	25	
JJM07224	7/16-14 x 7	25	
JJM07256	7/16-14 x 8	25	
JJM08024	1/2-13 x 3/4	50	
JJM08028	1/2-13 x 7/8	50	
JJM08032	1/2-13 x 1	50	
JJM08040	1/2-13 x 1 1/4	50	
JJM08048	1/2-13 x 1 1/2	50	
JJM08056	1/2-13 x 1 3/4	50	
JJM08064	1/2-13 x 2	50	
JJM08072	1/2-13 x 2 1/4	25	
JJM08080	1/2-13 x 2 1/2	25	
JJM08088	1/2-13 x 2 3/4	25	
JJM08096	1/2-13 x 3	25	

(continued...)

PART NUMBER	SIZE	QTY/BX	LIST PRICE
JJM08104	1/2-13 x 3 1/4	25	
JJM08112	1/2-13 x 3 1/2	25	
JJM08120	1/2-13 x 3 3/4	25	
JJM08128	1/2-13 x 4	25	
JJM08144	1/2-13 x 4 1/2	25	
JJM08160	1/2-13 x 5	25	
JJM08176	1/2-13 x 5 1/2	25	
JJM08192	1/2-13 x 6	25	
JJM08208	1/2-13 x 6 1/2	25	
JJM08224	1/2-13 x 7	25	
JJM08240	1/2-13 x 7 1/2	25	
JJM08256	1/2-13 x 8	25	
JJM08272	1/2-13 x 8 1/2	25	
JJM08288	1/2-13 x 9	25	
JJM08320	1/2-13 x 10	25	
JJM08384	1/2-13 x 12	10	
JJM09032	9/16-12 x 1	25	
JJM09040	9/16-12 x 1 1/4	25	
JJM09048	9/16-12 x 1 1/2	25	
JJM09056	9/16-12 x 1 3/4	25	
JJM09064	9/16-12 x 2	25	
JJM09072	9/16-12 x 2 1/4	25	
JJM09080	9/16-12 x 2 1/2	25	
JJM09088	9/16-12 x 2 3/4	25	
JJM09096	9/16-12 x 3	25	
JJM09104	9/16-12 x 3 1/4	25	
JJM09112	9/16-12 x 3 1/2	25	
JJM09120	9/16-12 x 3 3/4	25	
JJM09128	9/16-12 x 4	25	
JJM09144	9/16-12 x 4 1/2	25	
JJM09160	9/16-12 x 5	25	
JJM09176	9/16-12 x 5 1/2	25	
JJM09192	9/16-12 x 6	25	
JJM10032	5/8-11 x 1	25	
JJM10040	5/8-11 x 1 1/4	25	
JJM10048	5/8-11 x 1 1/2	25	
JJM10056	5/8-11 x 1 3/4	25	
JJM10064	5/8-11 x 2	25	
JJM10072	5/8-11 x 2 1/4	25	
JJM10080	5/8-11 x 2 1/2	25	
JJM10088	5/8-11 x 2 3/4	25	
JJM10096	5/8-11 x 3	25	
JJM10104	5/8-11 x 3 1/4	25	
JJM10112	5/8-11 x 3 1/2	25	

(continued...)

**GRADE 5 HEX CAP SCREW (cont.)**

ZINC PLATED, UNC - NORTH AMERICAN

Line: 148-01

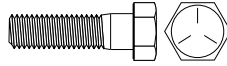

PART NUMBER	SIZE	QTY/BX	LIST PRICE
JJM14072	7/8-9 x 2 1/4	15	
JJM14080	7/8-9 x 2 1/2	15	
JJM14088	7/8-9 x 2 3/4	15	
JJM14096	7/8-9 x 3	15	
JJM14104	7/8-9 x 3 1/4	15	
JJM14112	7/8-9 x 3 1/2	15	
JJM14120	7/8-9 x 3 3/4	15	
JJM14128	7/8-9 x 4	15	
JJM14144	7/8-9 x 4 1/2	10	
JJM14160	7/8-9 x 5	10	
JJM14176	7/8-9 x 5 1/2	10	
JJM14192	7/8-9 x 6	10	
JJM14208	7/8-9 x 6 1/2	10	
JJM14224	7/8-9 x 7	10	
JJM14240	7/8-9 x 7 1/2	10	
JJM14256	7/8-9 x 8	10	
JJM14272	7/8-9 x 8 1/2	10	
JJM14288	7/8-9 x 9	10	
JJM14320	7/8-9 x 10	10	
JJM16048	1-8 x 1 1/2	10	
JJM16056	1-8 x 1 3/4	10	
JJM16064	1-8 x 2	10	
JJM16072	1-8 x 2 1/4	10	
JJM16080	1-8 x 2 1/2	10	
JJM16088	1-8 x 2 3/4	10	
JJM16096	1-8 x 3	10	
JJM16104	1-8 x 3 1/4	10	
JJM16112	1-8 x 3 1/2	10	
JJM16120	1-8 x 3 3/4	10	
JJM16128	1-8 x 4	10	
JJM16144	1-8 x 4 1/2	10	
JJM16160	1-8 x 5	10	
JJM16176	1-8 x 5 1/2	10	
JJM16192	1-8 x 6	10	
JJM16208	1-8 x 6 1/2	10	
JJM16224	1-8 x 7	5	
JJM16240	1-8 x 7 1/2	5	
JJM16256	1-8 x 8	5	
JJM16288	1-8 x 9	5	
JJM16320	1-8 x 10	5	
JJM18080	1 1/8-7 x 2 1/2	5	
JJM18096	1 1/8-7 x 3	5	
JJM18112	1 1/8-7 x 3 1/2	5	
JJM18128	1 1/8-7 x 4	5	

(continued...)

**GRADE 5 HEX CAP SCREW (cont.)**

ZINC PLATED, UNC - NORTH AMERICAN

Line: 148-01

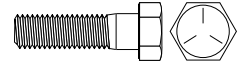

PART NUMBER	SIZE	QTY/BX	LIST PRICE
JJM18144	1 1/8-7 x 4 1/2	5	
JJM18160	1 1/8-7 x 5	5	
JJM18176	1 1/8-7 x 5 1/2	5	
JJM18192	1 1/8-7 x 6	5	
JJM18208	1 1/8-7 x 6 1/2	5	
JJM18224	1 1/8-7 x 7	5	
JJM18240	1 1/8-7 x 7 1/2	5	
JJM18256	1 1/8-7 x 8	5	
JJM18288	1 1/8-7 x 9	5	
JJM18320	1 1/8-7 x 10	5	
JJM20080	1 1/4-7 x 2 1/2	5	
JJM20096	1 1/4-7 x 3	5	
JJM20112	1 1/4-7 x 3 1/2	5	
JJM20128	1 1/4-7 x 4	5	
JJM20144	1 1/4-7 x 4 1/2	5	
JJM20160	1 1/4-7 x 5	5	
JJM20176	1 1/4-7 x 5 1/2	5	
JJM20192	1 1/4-7 x 6	5	
JJM20208	1 1/4-7 x 6 1/2	5	
JJM20224	1 1/4-7 x 7	5	
JJM20240	1 1/4-7 x 7 1/2	5	
JJM20256	1 1/4-7 x 8	5	
JJM20288	1 1/4-7 x 9	5	
JJM20320	1 1/4-7 x 10	5	

(continued...)

## GRADE 5 HEX CAP SCREW

PLAIN STEEL, UNC - NORTH AMERICAN

Line: 148-02

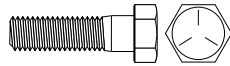

## GRADE 5 HEX CAP SCREW (cont.)

PLAIN STEEL, UNC - NORTH AMERICAN

Line: 148-02

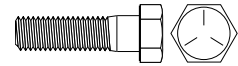

PART NUMBER	SIZE	QTY/BX	LIST PRICE
JJN04012	1/4-20 x 3/8	100	
JJN04016	1/4-20 x 1/2	100	
JJN04020	1/4-20 x 5/8	100	
JJN04024	1/4-20 x 3/4	100	
JJN04028	1/4-20 x 7/8	100	
JJN04032	1/4-20 x 1	100	
JJN04040	1/4-20 x 1 1/4	100	
JJN04048	1/4-20 x 1 1/2	100	
JJN04056	1/4-20 x 1 3/4	100	
JJN04064	1/4-20 x 2	100	
JJN04072	1/4-20 x 2 1/4	50	
JJN04080	1/4-20 x 2 1/2	100	
JJN04088	1/4-20 x 2 3/4	50	
JJN04096	1/4-20 x 3	50	
JJN04104	1/4-20 x 3 1/4	50	
JJN04112	1/4-20 x 3 1/2	50	
JJN04120	1/4-20 x 3 3/4	50	
JJN04128	1/4-20 x 4	50	
JJN04144	1/4-20 x 4 1/2	25	
JJN04160	1/4-20 x 5	50	
JJN04176	1/4-20 x 5 1/2	25	
JJN04192	1/4-20 x 6	25	
JJN05016	5/16-18 x 1/2	100	
JJN05020	5/16-18 x 5/8	100	
JJN05024	5/16-18 x 3/4	100	
JJN05028	5/16-18 x 7/8	100	
JJN05032	5/16-18 x 1	100	
JJN05040	5/16-18 x 1 1/4	100	
JJN05048	5/16-18 x 1 1/2	100	
JJN05056	5/16-18 x 1 3/4	100	
JJN05064	5/16-18 x 2	100	
JJN05072X	5/16-18 x 2 1/4	50	
JJN05080	5/16-18 x 2 1/2	50	
JJN05088X	5/16-18 x 2 3/4	50	
JJN05096	5/16-18 x 3	100	
JJN05104X	5/16-18 x 3 1/4	50	
JJN05112	5/16-18 x 3 1/2	50	
JJN05128	5/16-18 x 4	50	
JJN05144	5/16-18 x 4 1/2	50	
JJN05160	5/16-18 x 5	100	
JJN05176	5/16-18 x 5 1/2	50	
JJN05192	5/16-18 x 6	50	
JJN06020	3/8-16 x 5/8	100	
JJN06024	3/8-16 x 3/4	100	

(continued...)

PART NUMBER	SIZE	QTY/BX	LIST PRICE
JJN06028	3/8-16 x 7/8	100	
JJN06032	3/8-16 x 1	100	
JJN06040	3/8-16 x 1 1/4	100	
JJN06048	3/8-16 x 1 1/2	50	
JJN06056	3/8-16 x 1 3/4	50	
JJN06064	3/8-16 x 2	50	
JJN06072	3/8-16 x 2 1/4	50	
JJN06080	3/8-16 x 2 1/2	50	
JJN06088	3/8-16 x 2 3/4	50	
JJN06096	3/8-16 x 3	50	
JJN06104	3/8-16 x 3 1/4	25	
JJN06112	3/8-16 x 3 1/2	25	
JJN06120	3/8-16 x 3 3/4	25	
JJN06128	3/8-16 x 4	25	
JJN06144	3/8-16 x 4 1/2	25	
JJN06160	3/8-16 x 5	25	
JJN06176	3/8-16 x 5 1/2	25	
JJN06192	3/8-16 x 6	25	
JJN07024	7/16-14 x 3/4	50	
JJN07032	7/16-14 x 1	50	
JJN07040	7/16-14 x 1 1/4	50	
JJN07048	7/16-14 x 1 1/2	50	
JJN07056X	7/16-14 x 1 3/4	50	
JJN07064	7/16-14 x 2	50	
JJN07072X	7/16-14 x 2 1/4	25	
JJN07080	7/16-14 x 2 1/2	50	
JJN07088X	7/16-14 x 2 3/4	25	
JJN07096	7/16-14 x 3	50	
JJN07104	7/16-14 x 3 1/4	25	
JJN07112X	7/16-14 x 3 1/2	25	
JJN07128X	7/16-14 x 4	25	
JJN07144	7/16-14 x 4 1/2	25	
JJN07160	7/16-14 x 5	25	
JJN07176	7/16-14 x 5 1/2	25	
JJN07192	7/16-14 x 6	25	
JJN08024	1/2-13 x 3/4	50	
JJN08032	1/2-13 x 1	50	
JJN08040	1/2-13 x 1 1/4	50	
JJN08048	1/2-13 x 1 1/2	50	
JJN08056	1/2-13 x 1 3/4	50	
JJN08064	1/2-13 x 2	50	
JJN08072	1/2-13 x 2 1/4	25	
JJN08080	1/2-13 x 2 1/2	50	
JJN08088	1/2-13 x 2 3/4	25	

(continued...)

**GRADE 5 HEX CAP SCREW (cont.)**

PLAIN STEEL, UNC - NORTH AMERICAN

Line: 148-02

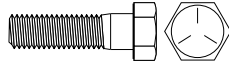

PART NUMBER	SIZE	QTY/BX	LIST PRICE
JJN08096	1/2-13 x 3	50	
JJN08104	1/2-13 x 3 1/4	25	
JJN08112	1/2-13 x 3 1/2	25	
JJN08120	1/2-13 x 3 3/4	25	
JJN08128	1/2-13 x 4	25	
JJN08144	1/2-13 x 4 1/2	25	
JJN08160	1/2-13 x 5	25	
JJN08176	1/2-13 x 5 1/2	25	
JJN08192	1/2-13 x 6	25	
JJN08224	1/2-13 x 7	25	
JJN08256	1/2-13 x 8	25	
JJN09032	9/16-12 x 1	25	
JJN09040	9/16-12 x 1 1/4	25	
JJN09048	9/16-12 x 1 1/2	25	
JJN09056	9/16-12 x 1 3/4	25	
JJN09064	9/16-12 x 2	25	
JJN09072	9/16-12 x 2 1/4	25	
JJN09080	9/16-12 x 2 1/2	25	
JJN09088	9/16-12 x 2 3/4	25	
JJN09096	9/16-12 x 3	25	
JJN09112	9/16-12 x 3 1/2	25	
JJN09128	9/16-12 x 4	25	
JJN10032	5/8-11 x 1	25	
JJN10040	5/8-11 x 1 1/4	25	
JJN10048	5/8-11 x 1 1/2	25	
JJN10056	5/8-11 x 1 3/4	25	
JJN10064	5/8-11 x 2	25	
JJN10072	5/8-11 x 2 1/4	25	
JJN10080	5/8-11 x 2 1/2	25	
JJN10088	5/8-11 x 2 3/4	25	
JJN10096	5/8-11 x 3	25	
JJN10104	5/8-11 x 3 1/4	25	
JJN10112	5/8-11 x 3 1/2	25	
JJN10120	5/8-11 x 3 3/4	25	
JJN10128	5/8-11 x 4	25	
JJN10144	5/8-11 x 4 1/2	25	
JJN10160	5/8-11 x 5	25	
JJN10176	5/8-11 x 5 1/2	25	
JJN10192	5/8-11 x 6	25	
JJN10208	5/8-11 x 6 1/2	25	
JJN10224	5/8-11 x 7	25	
JJN10240	5/8-11 x 7 1/2	25	
JJN10256	5/8-11 x 8	25	
JJN12040X	3/4-10 x 1 1/4	25	

(continued...)

**GRADE 5 HEX CAP SCREW (cont.)**

PLAIN STEEL, UNC - NORTH AMERICAN

Line: 148-02

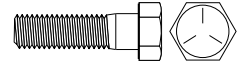

PART NUMBER	SIZE	QTY/BX	LIST PRICE
JJN12048	3/4-10 x 1 1/2	20	
JJN12056	3/4-10 x 1 3/4	25	
JJN12064	3/4-10 x 2	20	
JJN12072	3/4-10 x 2 1/4	25	
JJN12080	3/4-10 x 2 1/2	20	
JJN12088	3/4-10 x 2 3/4	25	
JJN12096	3/4-10 x 3	20	
JJN12104	3/4-10 x 3 1/4	25	
JJN12112	3/4-10 x 3 1/2	25	
JJN12120	3/4-10 x 3 3/4	25	
JJN12128	3/4-10 x 4	20	
JJN12144	3/4-10 x 4 1/2	20	
JJN12160	3/4-10 x 5	20	
JJN12176	3/4-10 x 5 1/2	20	
JJN12192	3/4-10 x 6	20	
JJN12208	3/4-10 x 6 1/2	10	
JJN12224	3/4-10 x 7	10	
JJN12240	3/4-10 x 7 1/2	10	
JJN12256	3/4-10 x 8	10	
JJN14048	7/8-9 x 1 1/2	15	
JJN14056	7/8-9 x 1 3/4	15	
JJN14064	7/8-9 x 2	15	
JJN14072	7/8-9 x 2 1/4	15	
JJN14080	7/8-9 x 2 1/2	15	
JJN14088	7/8-9 x 2 3/4	15	
JJN14096	7/8-9 x 3	20	
JJN14112	7/8-9 x 3 1/2	15	
JJN14128	7/8-9 x 4	20	
JJN14144	7/8-9 x 4 1/2	10	
JJN14160	7/8-9 x 5	10	
JJN14176	7/8-9 x 5 1/2	10	
JJN14192	7/8-9 x 6	10	
JJN14208	7/8-9 x 6 1/2	10	
JJN14224	7/8-9 x 7	10	
JJN14240	7/8-9 x 7 1/2	10	
JJN14256	7/8-9 x 8	10	
JJN16048	1-8 x 1 1/2	10	
JJN16056	1-8 x 1 3/4	10	
JJN16064	1-8 x 2	10	
JJN16072	1-8 x 2 1/4	10	
JJN16080	1-8 x 2 1/2	10	
JJN16088	1-8 x 2 3/4	10	
JJN16096	1-8 x 3	10	
JJN16104	1-8 x 3 1/4	10	

(continued...)

**GRADE 5 HEX CAP SCREW (cont.)**

PLAIN STEEL, UNC - NORTH AMERICAN

Line: 148-02

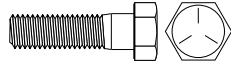
**GRADE 5 HEX CAP SCREW**

PLAIN STEEL, UNF - NORTH AMERICAN

Line: 148-03

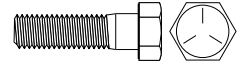

PAGE 3-30

CAP SCREWS - SECTION 03

PART NUMBER	SIZE	QTY/BX	LIST PRICE
JJN16112	1-8 x 3 1/2	10	
JJN16128	1-8 x 4	10	
JJN16144	1-8 x 4 1/2	10	
JJN16160	1-8 x 5	10	
JJN16176	1-8 x 5 1/2	10	
JJN16192	1-8 x 6	10	
JJN16208	1-8 x 6 1/2	10	
JJN16224	1-8 x 7	10	
JJN16240	1-8 x 7 1/2	1	
JJN16256	1-8 x 8	5	
JJN16272B	1-8 x 8 1/2	1	
JJN16288	1-8 x 9	5	
JJN16320	1-8 x 10	5	
JJN18080	1 1/8-7 x 2 1/2	5	
JJN18096	1 1/8-7 x 3	5	
JJN18112	1 1/8-7 x 3 1/2	5	
JJN18128	1 1/8-7 x 4	5	
JJN18144	1 1/8-7 x 4 1/2	5	
JJN18160	1 1/8-7 x 5	5	
JJN18176	1 1/8-7 x 5 1/2	5	
JJN18192	1 1/8-7 x 6	5	
JJN18208	1 1/8-7 x 6 1/2	5	
JJN18224	1 1/8-7 x 7	5	
JJN18240	1 1/8-7 x 7 1/2	5	
JJN18256	1 1/8-7 x 8	5	
JJN18288	1 1/8-7 x 9	1	
JJN18320	1 1/8-7 x 10	5	
JJN20080	1 1/4-7 x 2 1/2	5	
JJN20096	1 1/4-7 x 3	5	
JJN20112	1 1/4-7 x 3 1/2	5	
JJN20128	1 1/4-7 x 4	5	
JJN20144	1 1/4-7 x 4 1/2	5	
JJN20160	1 1/4-7 x 5	5	
JJN20176	1 1/4-7 x 5 1/2	5	
JJN20192	1 1/4-7 x 6	5	
JJN20208	1 1/4-7 x 6 1/2	5	
JJN20224	1 1/4-7 x 7	5	
JJN20240	1 1/4-7 x 7 1/2	5	
JJN20256	1 1/4-7 x 8	5	

PART NUMBER	SIZE	QTY/BX	LIST PRICE
JTR04016	1/4-28 x 1/2	100	
JTR04020	1/4-28 x 5/8	100	
JTR04024	1/4-28 x 3/4	100	
JTR04028	1/4-28 x 7/8	100	
JTR04032	1/4-28 x 1	100	
JTR04040	1/4-28 x 1 1/4	100	
JTR04048	1/4-28 x 1 1/2	100	
JTR04056	1/4-28 x 1 3/4	100	
JTR04064	1/4-28 x 2	100	
JTR04072	1/4-28 x 2 1/4	50	
JTR04080	1/4-28 x 2 1/2	50	
JTR04088	1/4-28 x 2 3/4	50	
JTR04096	1/4-28 x 3	50	
JTR04104	1/4-28 x 3 1/4	50	
JTR04112	1/4-28 x 3 1/2	50	
JTR04120	1/4-28 x 3 3/4	50	
JTR04128	1/4-28 x 4	50	
JTR04144	1/4-28 x 4 1/2	50	
JTR04160	1/4-28 x 5	50	
JTR04176	1/4-28 x 5 1/2	50	
JTR04192	1/4-28 x 6	50	
JTR05016	5/16-24 x 1/2	100	
JTR05020	5/16-24 x 5/8	100	
JTR05024	5/16-24 x 3/4	100	
JTR05028	5/16-24 x 7/8	100	
JTR05032	5/16-24 x 1	100	
JTR05040	5/16-24 x 1 1/4	100	
JTR05048	5/16-24 x 1 1/2	100	
JTR05056	5/16-24 x 1 3/4	100	
JTR05064	5/16-24 x 2	100	
JTR05072	5/16-24 x 2 1/4	50	
JTR05080	5/16-24 x 2 1/2	50	
JTR05088	5/16-24 x 2 3/4	50	
JTR05096	5/16-24 x 3	50	
JTR05104	5/16-24 x 3 1/4	50	
JTR05112	5/16-24 x 3 1/2	50	
JTR05120	5/16-24 x 3 3/4	50	
JTR05128	5/16-24 x 4	50	
JTR05144	5/16-24 x 4 1/2	50	
JTR05160	5/16-24 x 5	50	
JTR05176	5/16-24 x 5 1/2	25	
JTR05192	5/16-24 x 6	25	
JTR06016	3/8-24 x 1/2	100	

(continued...)

**GRADE 5 HEX CAP SCREW (cont.)**

PLAIN STEEL, UNF - NORTH AMERICAN

Line: 148-03

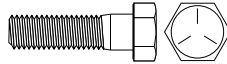

PART NUMBER	SIZE	QTY/BX	LIST PRICE
JTR06020	3/8-24 x 5/8	100	
JTR06024	3/8-24 x 3/4	100	
JTR06028	3/8-24 x 7/8	100	
JTR06032	3/8-24 x 1	100	
JTR06040	3/8-24 x 1 1/4	100	
JTR06048	3/8-24 x 1 1/2	100	
JTR06056	3/8-24 x 1 3/4	50	
JTR06064	3/8-24 x 2	50	
JTR06072	3/8-24 x 2 1/4	50	
JTR06080	3/8-24 x 2 1/2	50	
JTR06088	3/8-24 x 2 3/4	50	
JTR06096	3/8-24 x 3	50	
JTR06104	3/8-24 x 3 1/4	25	
JTR06112	3/8-24 x 3 1/2	25	
JTR06120	3/8-24 x 3 3/4	25	
JTR06128	3/8-24 x 4	25	
JTR06144	3/8-24 x 4 1/2	25	
JTR06160	3/8-24 x 5	25	
JTR06176	3/8-24 x 5 1/2	25	
JTR06192	3/8-24 x 6	25	
JTR06224	3/8-24 x 7	25	
JTR06256	3/8-24 x 8	25	
JTR07024	7/16-20 x 3/4	50	
JTR07032	7/16-20 x 1	50	
JTR07040	7/16-20 x 1 1/4	50	
JTR07048	7/16-20 x 1 1/2	50	
JTR07056	7/16-20 x 1 3/4	50	
JTR07064	7/16-20 x 2	50	
JTR07072	7/16-20 x 2 1/4	25	
JTR07080	7/16-20 x 2 1/2	25	
JTR07088	7/16-20 x 2 3/4	25	
JTR07096	7/16-20 x 3	25	
JTR07104	7/16-20 x 3 1/4	25	
JTR07112	7/16-20 x 3 1/2	25	
JTR07120	7/16-20 x 3 3/4	25	
JTR07128	7/16-20 x 4	25	
JTR07144	7/16-20 x 4 1/2	25	
JTR07160	7/16-20 x 5	25	
JTR07176	7/16-20 x 5 1/2	25	
JTR07192	7/16-20 x 6	25	
JTR07224	7/16-20 x 7	25	
JTR07256	7/16-20 x 8	25	
JTR08024	1/2-20 x 3/4	50	
JTR08028	1/2-20 x 7/8	50	

(continued...)

**GRADE 5 HEX CAP SCREW (cont.)**

PLAIN STEEL, UNF - NORTH AMERICAN

Line: 148-03

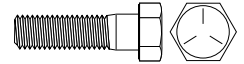

PART NUMBER	SIZE	QTY/BX	LIST PRICE
JTR08032	1/2-20 x 1	50	
JTR08040	1/2-20 x 1 1/4	50	
JTR08048	1/2-20 x 1 1/2	50	
JTR08056	1/2-20 x 1 3/4	50	
JTR08064	1/2-20 x 2	50	
JTR08072	1/2-20 x 2 1/4	25	
JTR08080	1/2-20 x 2 1/2	25	
JTR08088	1/2-20 x 2 3/4	25	
JTR08096	1/2-20 x 3	25	
JTR08104	1/2-20 x 3 1/4	25	
JTR08112	1/2-20 x 3 1/2	25	
JTR08120	1/2-20 x 3 3/4	25	
JTR08128	1/2-20 x 4	25	
JTR08144	1/2-20 x 4 1/2	25	
JTR08160	1/2-20 x 5	25	
JTR08176	1/2-20 x 5 1/2	25	
JTR08192	1/2-20 x 6	25	
JTR08208	1/2-20 x 6 1/2	25	
JTR08224	1/2-20 x 7	25	
JTR08240	1/2-20 x 7 1/2	25	
JTR08256	1/2-20 x 8	25	
JTR09032	9/16-18 x 1	25	
JTR09040	9/16-18 x 1 1/4	25	
JTR09048	9/16-18 x 1 1/2	25	
JTR09056	9/16-18 x 1 3/4	25	
JTR09064	9/16-18 x 2	25	
JTR09072	9/16-18 x 2 1/4	25	
JTR09080	9/16-18 x 2 1/2	25	
JTR09088	9/16-18 x 2 3/4	25	
JTR09096	9/16-18 x 3	25	
JTR09104	9/16-18 x 3 1/4	25	
JTR09112	9/16-18 x 3 1/2	25	
JTR09120	9/16-18 x 3 3/4	25	
JTR09128	9/16-18 x 4	25	
JTR09144	9/16-18 x 4 1/2	25	
JTR09160	9/16-18 x 5	25	
JTR09176	9/16-18 x 5 1/2	25	
JTR09192	9/16-18 x 6	25	
JTR09240	9/16-18 x 7 1/2	25	
JTR10032	5/8-18 x 1	25	
JTR10040	5/8-18 x 1 1/4	25	
JTR10048	5/8-18 x 1 1/2	25	
JTR10056	5/8-18 x 1 3/4	25	
JTR10064	5/8-18 x 2	25	

(continued...)

**GRADE 5 HEX CAP SCREW (cont.)**

PLAIN STEEL, UNF - NORTH AMERICAN

Line: 148-03

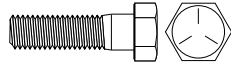
**GRADE 5 HEX CAP SCREW (cont.)**

PLAIN STEEL, UNF - NORTH AMERICAN

Line: 148-03

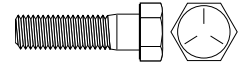

PAGE 3-32

CAP SCREWS - SECTION 03

PART NUMBER	SIZE	QTY/BX	LIST PRICE
JTR10072	5/8-18 x 2 1/4	25	
JTR10080	5/8-18 x 2 1/2	25	
JTR10088	5/8-18 x 2 3/4	25	
JTR10096	5/8-18 x 3	25	
JTR10104	5/8-18 x 3 1/4	25	
JTR10112	5/8-18 x 3 1/2	25	
JTR10120	5/8-18 x 3 3/4	25	
JTR10128	5/8-18 x 4	25	
JTR10144	5/8-18 x 4 1/2	25	
JTR10160	5/8-18 x 5	25	
JTR10176	5/8-18 x 5 1/2	25	
JTR10192	5/8-18 x 6	25	
JTR10208	5/8-18 x 6 1/2	25	
JTR10224	5/8-18 x 7	25	
JTR10240	5/8-18 x 7 1/2	25	
JTR10256	5/8-18 x 8	25	
JTR10288	5/8-18 x 9	10	
JTR10320	5/8-18 x 10	10	
JTR12032	3/4-16 x 1	25	
JTR12040	3/4-16 x 1 1/4	25	
JTR12048	3/4-16 x 1 1/2	25	
JTR12056	3/4-16 x 1 3/4	25	
JTR12064	3/4-16 x 2	25	
JTR12072	3/4-16 x 2 1/4	25	
JTR12080	3/4-16 x 2 1/2	25	
JTR12088	3/4-16 x 2 3/4	25	
JTR12096	3/4-16 x 3	25	
JTR12104	3/4-16 x 3 1/4	25	
JTR12112	3/4-16 x 3 1/2	25	
JTR12120	3/4-16 x 3 3/4	25	
JTR12128	3/4-16 x 4	10	
JTR12144	3/4-16 x 4 1/2	10	
JTR12160	3/4-16 x 5	10	
JTR12176	3/4-16 x 5 1/2	10	
JTR12192	3/4-16 x 6	10	
JTR12208	3/4-16 x 6 1/2	10	
JTR12224	3/4-16 x 7	10	
JTR12240	3/4-16 x 7 1/2	10	
JTR12256	3/4-16 x 8	10	
JTR12288	3/4-16 x 9	10	
JTR12320	3/4-16 x 10	10	
JTR14048	7/8-14 x 1 1/2	15	
JTR14056	7/8-14 x 1 3/4	15	
JTR14064	7/8-14 x 2	15	

(continued...)

PART NUMBER	SIZE	QTY/BX	LIST PRICE
JTR14072	7/8-14 x 2 1/4	15	
JTR14080	7/8-14 x 2 1/2	15	
JTR14088	7/8-14 x 2 3/4	15	
JTR14096	7/8-14 x 3	15	
JTR14104	7/8-14 x 3 1/4	15	
JTR14112	7/8-14 x 3 1/2	15	
JTR14120	7/8-14 x 3 3/4	15	
JTR14128	7/8-14 x 4	15	
JTR14144	7/8-14 x 4 1/2	10	
JTR14160	7/8-14 x 5	10	
JTR14176	7/8-14 x 5 1/2	10	
JTR14192	7/8-14 x 6	10	
JTR14208	7/8-14 x 6 1/2	10	
JTR14224	7/8-14 x 7	10	
JTR14240	7/8-14 x 7 1/2	10	
JTR14256	7/8-14 x 8	10	
JTR16048	1-14 x 1 1/2	10	
JTR16056	1-14 x 1 3/4	10	
JTR16064	1-14 x 2	10	
JTR16072	1-14 x 2 1/4	10	
JTR16080	1-14 x 2 1/2	10	
JTR16088	1-14 x 2 3/4	10	
JTR16096	1-14 x 3	10	
JTR16104	1-14 x 3 1/4	10	
JTR16112	1-14 x 3 1/2	10	
JTR16120	1-14 x 3 3/4	10	
JTR16128	1-14 x 4	10	
JTR16144	1-14 x 4 1/2	10	
JTR16160	1-14 x 5	10	
JTR16176	1-14 x 5 1/2	10	
JTR16192	1-14 x 6	10	
JTR16208	1-14 x 6 1/2	10	
JTR16224	1-14 x 7	10	
JTR16240	1-14 x 7 1/2	10	
JTR16256	1-14 x 8	10	
JTR16288	1-14 x 9	5	
JTR16320	1-14 x 10	5	



## GRADE 8 HEX CAP SCREW

ZINC YELLOW, UNC - NORTH AMERICAN

Line: 148-05

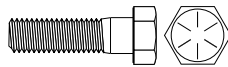

PART NUMBER	SIZE	QTY/BX	LIST PRICE
JKR04016	1/4-20 x 1/2	100	
JKR04020	1/4-20 x 5/8	100	
JKR04024	1/4-20 x 3/4	100	
JKR04028	1/4-20 x 7/8	100	
JKR04032	1/4-20 x 1	100	
JKR04040	1/4-20 x 1 1/4	100	
JKR04048	1/4-20 x 1 1/2	100	
JKR04056	1/4-20 x 1 3/4	100	
JKR04064	1/4-20 x 2	100	
JKR04072	1/4-20 x 2 1/4	50	
JKR04080	1/4-20 x 2 1/2	50	
JKR04088	1/4-20 x 2 3/4	50	
JKR04096	1/4-20 x 3	50	
JKR04112	1/4-20 x 3 1/2	50	
JKR04120	1/4-20 x 3 3/4	50	
JKR04128	1/4-20 x 4	50	
JKR04144	1/4-20 x 4 1/2	50	
JKR04160	1/4-20 x 5	50	
JKR04176	1/4-20 x 5 1/2	50	
JKR04192	1/4-20 x 6	50	
JKR05016	5/16-18 x 1/2	100	
JKR05020	5/16-18 x 5/8	100	
JKR05024	5/16-18 x 3/4	100	
JKR05028	5/16-18 x 7/8	100	
JKR05032	5/16-18 x 1	100	
JKR05040	5/16-18 x 1 1/4	100	
JKR05048	5/16-18 x 1 1/2	100	
JKR05056	5/16-18 x 1 3/4	100	
JKR05064	5/16-18 x 2	100	
JKR05072	5/16-18 x 2 1/4	50	
JKR05080	5/16-18 x 2 1/2	50	
JKR05088	5/16-18 x 2 3/4	50	
JKR05096	5/16-18 x 3	50	
JKR05104	5/16-18 x 3 1/4	50	
JKR05112	5/16-18 x 3 1/2	50	
JKR05120	5/16-18 x 3 3/4	25	
JKR05128	5/16-18 x 4	50	
JKR05144	5/16-18 x 4 1/2	50	
JKR05160	5/16-18 x 5	50	
JKR05176	5/16-18 x 5 1/2	25	
JKR05192	5/16-18 x 6	25	
JKR06016	3/8-16 x 1/2	100	
JKR06020	3/8-16 x 5/8	100	
JKR06024	3/8-16 x 3/4	100	

(continued...)

## GRADE 8 HEX CAP SCREW (cont.)

ZINC YELLOW, UNC - NORTH AMERICAN

Line: 148-05

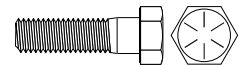

PART NUMBER	SIZE	QTY/BX	LIST PRICE
JKR06028	3/8-16 x 7/8	100	
JKR06032	3/8-16 x 1	100	
JKR06040	3/8-16 x 1 1/4	100	
JKR06048	3/8-16 x 1 1/2	100	
JKR06052	3/8-16 x 1 5/8	50	
JKR06056	3/8-16 x 1 3/4	50	
JKR06064	3/8-16 x 2	50	
JKR06072	3/8-16 x 2 1/4	50	
JKR06080	3/8-16 x 2 1/2	50	
JKR06088	3/8-16 x 2 3/4	50	
JKR06096	3/8-16 x 3	50	
JKR06104	3/8-16 x 3 1/4	25	
JKR06112	3/8-16 x 3 1/2	25	
JKR06120	3/8-16 x 3 3/4	25	
JKR06128	3/8-16 x 4	25	
JKR06144	3/8-16 x 4 1/2	25	
JKR06160	3/8-16 x 5	25	
JKR06176	3/8-16 x 5 1/2	25	
JKR06192	3/8-16 x 6	25	
JKR06208	3/8-16 x 6 1/2	25	
JKR06224	3/8-16 x 7	25	
JKR06256	3/8-16 x 8	25	
JKR07024	7/16-14 x 3/4	50	
JKR07028	7/16-14 x 7/8	50	
JKR07032	7/16-14 x 1	50	
JKR07040	7/16-14 x 1 1/4	50	
JKR07048	7/16-14 x 1 1/2	50	
JKR07056	7/16-14 x 1 3/4	50	
JKR07064	7/16-14 x 2	50	
JKR07072	7/16-14 x 2 1/4	25	
JKR07080	7/16-14 x 2 1/2	25	
JKR07088	7/16-14 x 2 3/4	25	
JKR07096	7/16-14 x 3	25	
JKR07104	7/16-14 x 3 1/4	25	
JKR07112	7/16-14 x 3 1/2	25	
JKR07120	7/16-14 x 3 3/4	25	
JKR07128	7/16-14 x 4	25	
JKR07144	7/16-14 x 4 1/2	25	
JKR07160	7/16-14 x 5	25	
JKR07176	7/16-14 x 5 1/2	25	
JKR07192	7/16-14 x 6	25	
JKR07224	7/16-14 x 7	25	
JKR08024	1/2-13 x 3/4	50	
JKR08028	1/2-13 x 7/8	50	

(continued...)

**GRADE 8 HEX CAP SCREW (cont.)**

ZINC YELLOW, UNC - NORTH AMERICAN

Line: 148-05

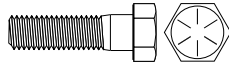
**GRADE 8 HEX CAP SCREW (cont.)**

ZINC YELLOW, UNC - NORTH AMERICAN

Line: 148-05

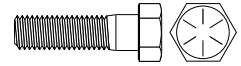

PAGE 3-34

CAP SCREWS - SECTION 03

PART NUMBER	SIZE	QTY/BX	LIST PRICE
JKR08032	1/2-13 x 1	50	
JKR08040	1/2-13 x 1 1/4	50	
JKR08048	1/2-13 x 1 1/2	50	
JKR08056	1/2-13 x 1 3/4	50	
JKR08064	1/2-13 x 2	50	
JKR08072	1/2-13 x 2 1/4	25	
JKR08080	1/2-13 x 2 1/2	25	
JKR08088	1/2-13 x 2 3/4	25	
JKR08096	1/2-13 x 3	25	
JKR08104	1/2-13 x 3 1/4	25	
JKR08112	1/2-13 x 3 1/2	25	
JKR08120	1/2-13 x 3 3/4	25	
JKR08128	1/2-13 x 4	25	
JKR08144	1/2-13 x 4 1/2	25	
JKR08160	1/2-13 x 5	25	
JKR08176	1/2-13 x 5 1/2	25	
JKR08192	1/2-13 x 6	25	
JKR08208	1/2-13 x 6 1/2	25	
JKR08224	1/2-13 x 7	25	
JKR08256	1/2-13 x 8	25	
JKR08288	1/2-13 x 9	25	
JKR09032	9/16-12 x 1	25	
JKR09040	9/16-12 x 1 1/4	25	
JKR09048	9/16-12 x 1 1/2	25	
JKR09056	9/16-12 x 1 3/4	25	
JKR09064	9/16-12 x 2	25	
JKR09072	9/16-12 x 2 1/4	25	
JKR09080	9/16-12 x 2 1/2	25	
JKR09088	9/16-12 x 2 3/4	25	
JKR09096	9/16-12 x 3	25	
JKR09104	9/16-12 x 3 1/4	25	
JKR09112	9/16-12 x 3 1/2	25	
JKR09120	9/16-12 x 3 3/4	25	
JKR09128	9/16-12 x 4	25	
JKR09144	9/16-12 x 4 1/2	25	
JKR09160	9/16-12 x 5	25	
JKR09176	9/16-12 x 5 1/2	25	
JKR09192	9/16-12 x 6	25	
JKR10032	5/8-11 x 1	25	
JKR10040	5/8-11 x 1 1/4	25	
JKR10048	5/8-11 x 1 1/2	25	
JKR10056	5/8-11 x 1 3/4	25	
JKR10064	5/8-11 x 2	25	
JKR10072	5/8-11 x 2 1/4	25	

(continued...)

PART NUMBER	SIZE	QTY/BX	LIST PRICE
JKR10080	5/8-11 x 2 1/2	25	
JKR10088	5/8-11 x 2 3/4	25	
JKR10096	5/8-11 x 3	25	
JKR10104	5/8-11 x 3 1/4	25	
JKR10112	5/8-11 x 3 1/2	25	
JKR10120	5/8-11 x 3 3/4	25	
JKR10128	5/8-11 x 4	25	
JKR10144	5/8-11 x 4 1/2	25	
JKR10160	5/8-11 x 5	25	
JKR10176	5/8-11 x 5 1/2	25	
JKR10192	5/8-11 x 6	25	
JKR10208	5/8-11 x 6 1/2	25	
JKR10224	5/8-11 x 7	25	
JKR10240	5/8-11 x 7 1/2	25	
JKR10256	5/8-11 x 8	25	
JKR10272	5/8-11 x 8 1/2	10	
JKR10320	5/8-11 x 10	10	
JKR12032	3/4-10 x 1	25	
JKR12040	3/4-10 x 1 1/4	25	
JKR12048	3/4-10 x 1 1/2	25	
JKR12056	3/4-10 x 1 3/4	25	
JKR12064	3/4-10 x 2	25	
JKR12072	3/4-10 x 2 1/4	25	
JKR12080	3/4-10 x 2 1/2	25	
JKR12088	3/4-10 x 2 3/4	25	
JKR12096	3/4-10 x 3	25	
JKR12104	3/4-10 x 3 1/4	25	
JKR12112	3/4-10 x 3 1/2	25	
JKR12120	3/4-10 x 3 3/4	25	
JKR12128	3/4-10 x 4	25	
JKR12144	3/4-10 x 4 1/2	10	
JKR12160	3/4-10 x 5	10	
JKR12176	3/4-10 x 5 1/2	10	
JKR12192	3/4-10 x 6	10	
JKR12208	3/4-10 x 6 1/2	10	
JKR12224	3/4-10 x 7	10	
JKR12240	3/4-10 x 7 1/2	10	
JKR12256	3/4-10 x 8	10	
JKR12288	3/4-10 x 9	10	
JKR12320	3/4-10 x 10	10	
JKR14048	7/8-9 x 1 1/2	15	
JKR14056	7/8-9 x 1 3/4	15	
JKR14064	7/8-9 x 2	15	
JKR14072	7/8-9 x 2 1/4	15	

(continued...)

**GRADE 8 HEX CAP SCREW (cont.)**

ZINC YELLOW, UNC - NORTH AMERICAN

Line: 148-05

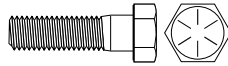

PART NUMBER	SIZE	QTY/BX	LIST PRICE
JKR14080	7/8-9 x 2 1/2	15	
JKR14088	7/8-9 x 2 3/4	15	
JKR14096	7/8-9 x 3	15	
JKR14104	7/8-9 x 3 1/4	15	
JKR14112	7/8-9 x 3 1/2	15	
JKR14120	7/8-9 x 3 3/4	15	
JKR14128	7/8-9 x 4	15	
JKR14144	7/8-9 x 4 1/2	10	
JKR14160	7/8-9 x 5	10	
JKR14176	7/8-9 x 5 1/2	10	
JKR14192	7/8-9 x 6	10	
JKR14208	7/8-9 x 6 1/2	10	
JKR14224	7/8-9 x 7	10	
JKR14240	7/8-9 x 7 1/2	10	
JKR14256	7/8-9 x 8	10	
JKR14288	7/8-9 x 9	10	
JKR14320	7/8-9 x 10	10	
JKR16048	1-8 x 1 1/2	10	
JKR16056	1-8 x 1 3/4	10	
JKR16064	1-8 x 2	10	
JKR16072	1-8 x 2 1/4	10	
JKR16080	1-8 x 2 1/2	10	
JKR16088	1-8 x 2 3/4	10	
JKR16096	1-8 x 3	10	
JKR16104	1-8 x 3 1/4	10	
JKR16112	1-8 x 3 1/2	10	
JKR16120	1-8 x 3 3/4	10	
JKR16128	1-8 x 4	10	
JKR16144	1-8 x 4 1/2	10	
JKR16160	1-8 x 5	10	
JKR16176	1-8 x 5 1/2	10	
JKR16192	1-8 x 6	10	
JKR16208	1-8 x 6 1/2	10	
JKR16224	1-8 x 7	10	
JKR16240	1-8 x 7 1/2	5	
JKR16256	1-8 x 8	5	
JKR16288	1-8 x 9	5	
JKR16304	1-8 x 9 1/2	5	
JKR16320	1-8 x 10	5	
JKR18080	1 1/8-7 x 2 1/2	5	
JKR18096	1 1/8-7 x 3	5	
JKR18112	1 1/8-7 x 3 1/2	5	
JKR18128	1 1/8-7 x 4	5	
JKR18144	1 1/8-7 x 4 1/2	5	

(continued...)

**GRADE 8 HEX CAP SCREW (cont.)**

ZINC YELLOW, UNC - NORTH AMERICAN

Line: 148-05

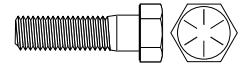

PART NUMBER	SIZE	QTY/BX	LIST PRICE
JKR18160	1 1/8-7 x 5	5	
JKR18176	1 1/8-7 x 5 1/2	5	
JKR18192	1 1/8-7 x 6	5	
JKR18208	1 1/8-7 x 6 1/2	5	
JKR18224	1 1/8-7 x 7	5	
JKR18240	1 1/8-7 x 7 1/2	5	
JKR18256	1 1/8-7 x 8	5	
JKR18288	1 1/8-7 x 9	5	
JKR18320	1 1/8-7 x 10	5	
JKR20080	1 1/4-7 x 2 1/2	5	
JKR20096	1 1/4-7 x 3	5	
JKR20112	1 1/4-7 x 3 1/2	5	
JKR20128	1 1/4-7 x 4	5	
JKR20144	1 1/4-7 x 4 1/2	5	
JKR20160	1 1/4-7 x 5	5	
JKR20176	1 1/4-7 x 5 1/2	5	
JKR20192	1 1/4-7 x 6	5	
JKR20208	1 1/4-7 x 6 1/2	5	
JKR20224	1 1/4-7 x 7	5	
JKR20240	1 1/4-7 x 7 1/2	5	
JKR20256	1 1/4-7 x 8	5	
JKR20288	1 1/4-7 x 9	5	
JKR20320	1 1/4-7 x 10	5	

# GRADE 8 HEX CAP SCREW

ZINC YELLOW, UNF - NORTH AMERICAN

Line: 148-07

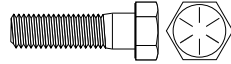

# GRADE 8 HEX CAP SCREW (cont.)

ZINC YELLOW, UNF - NORTH AMERICAN

Line: 148-07

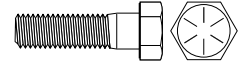

PAGE 3-36

CAP SCREWS - SECTION 03

PART NUMBER	SIZE	QTY/BX	LIST PRICE
JAS04016	1/4-28 x 1/2	100	
JAS04020	1/4-28 x 5/8	100	
JAS04024	1/4-28 x 3/4	100	
JAS04028	1/4-28 x 7/8	100	
JAS04032	1/4-28 x 1	100	
JAS04040	1/4-28 x 1 1/4	100	
JAS04048	1/4-28 x 1 1/2	100	
JAS04056	1/4-28 x 1 3/4	100	
JAS04064	1/4-28 x 2	100	
JAS04072	1/4-28 x 2 1/4	50	
JAS04080	1/4-28 x 2 1/2	50	
JAS04088	1/4-28 x 2 3/4	50	
JAS04096	1/4-28 x 3	50	
JAS04104	1/4-28 x 3 1/4	50	
JAS04112	1/4-28 x 3 1/2	50	
JAS04120	1/4-28 x 3 3/4	50	
JAS04128	1/4-28 x 4	50	
JAS04144	1/4-28 x 4 1/2	50	
JAS04160	1/4-28 x 5	50	
JAS04176	1/4-28 x 5 1/2	50	
JAS04192	1/4-28 x 6	50	
JAS04208	1/4-28 x 6 1/2	25	
JAS04240	1/4-28 x 7 1/2	25	
JAS05016	5/16-24 x 1/2	100	
JAS05020	5/16-24 x 5/8	100	
JAS05024	5/16-24 x 3/4	100	
JAS05028	5/16-24 x 7/8	100	
JAS05032	5/16-24 x 1	100	
JAS05040	5/16-24 x 1 1/4	100	
JAS05048	5/16-24 x 1 1/2	100	
JAS05056	5/16-24 x 1 3/4	100	
JAS05064	5/16-24 x 2	100	
JAS05072	5/16-24 x 2 1/4	50	
JAS05080	5/16-24 x 2 1/2	50	
JAS05088	5/16-24 x 2 3/4	50	
JAS05096	5/16-24 x 3	50	
JAS05104	5/16-24 x 3 1/4	50	
JAS05112	5/16-24 x 3 1/2	50	
JAS05120	5/16-24 x 3 3/4	50	
JAS05128	5/16-24 x 4	50	
JAS05144	5/16-24 x 4 1/2	50	
JAS05160	5/16-24 x 5	50	
JAS05176	5/16-24 x 5 1/2	50	
JAS05192	5/16-24 x 6	50	

(continued...)

PART NUMBER	SIZE	QTY/BX	LIST PRICE
JAS06016	3/8-24 x 1/2	100	
JAS06020	3/8-24 x 5/8	100	
JAS06024	3/8-24 x 3/4	100	
JAS06028	3/8-24 x 7/8	100	
JAS06032	3/8-24 x 1	100	
JAS06040	3/8-24 x 1 1/4	100	
JAS06048	3/8-24 x 1 1/2	100	
JAS06056	3/8-24 x 1 3/4	50	
JAS06064	3/8-24 x 2	50	
JAS06072	3/8-24 x 2 1/4	50	
JAS06080	3/8-24 x 2 1/2	50	
JAS06088	3/8-24 x 2 3/4	50	
JAS06096	3/8-24 x 3	50	
JAS06104	3/8-24 x 3 1/4	25	
JAS06112	3/8-24 x 3 1/2	25	
JAS06120	3/8-24 x 3 3/4	25	
JAS06128	3/8-24 x 4	25	
JAS06144	3/8-24 x 4 1/2	25	
JAS06160	3/8-24 x 5	25	
JAS06176	3/8-24 x 5 1/2	25	
JAS06192	3/8-24 x 6	25	
JAS06208	3/8-24 x 6 1/2	25	
JAS06256	3/8-24 x 8	25	
JAS07024	7/16-20 x 3/4	50	
JAS07032	7/16-20 x 1	50	
JAS07040	7/16-20 x 1 1/4	50	
JAS07048	7/16-20 x 1 1/2	50	
JAS07056	7/16-20 x 1 3/4	50	
JAS07064	7/16-20 x 2	50	
JAS07072	7/16-20 x 2 1/4	25	
JAS07080	7/16-20 x 2 1/2	25	
JAS07088	7/16-20 x 2 3/4	25	
JAS07096	7/16-20 x 3	25	
JAS07104	7/16-20 x 3 1/4	25	
JAS07112	7/16-20 x 3 1/2	25	
JAS07120	7/16-20 x 3 3/4	25	
JAS07128	7/16-20 x 4	25	
JAS07144	7/16-20 x 4 1/2	25	
JAS07160	7/16-20 x 5	25	
JAS07176	7/16-20 x 5 1/2	25	
JAS07192	7/16-20 x 6	25	
JAS07320	7/16-20 x 10	25	
JAS08024	1/2-20 x 3/4	50	
JAS08028	1/2-20 x 7/8	50	

(continued...)

**GRADE 8 HEX CAP SCREW (cont.)**

ZINC YELLOW, UNF - NORTH AMERICAN

Line: 148-07

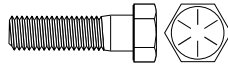

PART NUMBER	SIZE	QTY/BX	LIST PRICE
JAS08032	1/2-20 x 1	50	
JAS08040	1/2-20 x 1 1/4	50	
JAS08048	1/2-20 x 1 1/2	50	
JAS08056	1/2-20 x 1 3/4	50	
JAS08064	1/2-20 x 2	50	
JAS08072	1/2-20 x 2 1/4	25	
JAS08080	1/2-20 x 2 1/2	25	
JAS08088	1/2-20 x 2 3/4	25	
JAS08096	1/2-20 x 3	25	
JAS08104	1/2-20 x 3 1/4	25	
JAS08112	1/2-20 x 3 1/2	25	
JAS08120	1/2-20 x 3 3/4	25	
JAS08128	1/2-20 x 4	25	
JAS08144	1/2-20 x 4 1/2	25	
JAS08160	1/2-20 x 5	25	
JAS08176	1/2-20 x 5 1/2	25	
JAS08192	1/2-20 x 6	25	
JAS08208	1/2-20 x 6 1/2	25	
JAS08224	1/2-20 x 7	25	
JAS08240	1/2-20 x 7 1/2	25	
JAS08256	1/2-20 x 8	25	
JAS09032	9/16-18 x 1	25	
JAS09040	9/16-18 x 1 1/4	25	
JAS09048	9/16-18 x 1 1/2	25	
JAS09056	9/16-18 x 1 3/4	25	
JAS09064	9/16-18 x 2	25	
JAS09072	9/16-18 x 2 1/4	25	
JAS09080	9/16-18 x 2 1/2	25	
JAS09088	9/16-18 x 2 3/4	25	
JAS09096	9/16-18 x 3	25	
JAS09112	9/16-18 x 3 1/2	25	
JAS09120	9/16-18 x 3 3/4	25	
JAS09128	9/16-18 x 4	25	
JAS09144	9/16-18 x 4 1/2	25	
JAS09160	9/16-18 x 5	25	
JAS09176	9/16-18 x 5 1/2	25	
JAS09192	9/16-18 x 6	25	
JAS10032	5/8-18 x 1	25	
JAS10040	5/8-18 x 1 1/4	25	
JAS10048	5/8-18 x 1 1/2	25	
JAS10056	5/8-18 x 1 3/4	25	
JAS10064	5/8-18 x 2	25	
JAS10072	5/8-18 x 2 1/4	25	
JAS10080	5/8-18 x 2 1/2	25	

(continued...)

**GRADE 8 HEX CAP SCREW (cont.)**

ZINC YELLOW, UNF - NORTH AMERICAN

Line: 148-07

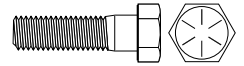

PART NUMBER	SIZE	QTY/BX	LIST PRICE
JAS10088	5/8-18 x 2 3/4	25	
JAS10096	5/8-18 x 3	25	
JAS10104	5/8-18 x 3 1/4	25	
JAS10112	5/8-18 x 3 1/2	25	
JAS10120	5/8-18 x 3 3/4	25	
JAS10128	5/8-18 x 4	25	
JAS10144	5/8-18 x 4 1/2	25	
JAS10160	5/8-18 x 5	25	
JAS10176	5/8-18 x 5 1/2	25	
JAS10192	5/8-18 x 6	25	
JAS10208	5/8-18 x 6 1/2	25	
JAS10224	5/8-18 x 7	25	
JAS10240	5/8-18 x 7 1/2	25	
JAS10256	5/8-18 x 8	25	
JAS10288	5/8-18 x 9	25	
JAS10320	5/8-18 x 10	10	
JAS12032	3/4-16 x 1	25	
JAS12040	3/4-16 x 1 1/4	25	
JAS12048	3/4-16 x 1 1/2	25	
JAS12056	3/4-16 x 1 3/4	25	
JAS12064	3/4-16 x 2	25	
JAS12072	3/4-16 x 2 1/4	25	
JAS12080	3/4-16 x 2 1/2	25	
JAS12088	3/4-16 x 2 3/4	25	
JAS12096	3/4-16 x 3	25	
JAS12104	3/4-16 x 3 1/4	25	
JAS12112	3/4-16 x 3 1/2	25	
JAS12120	3/4-16 x 3 3/4	25	
JAS12128	3/4-16 x 4	25	
JAS12144	3/4-16 x 4 1/2	10	
JAS12160	3/4-16 x 5	10	
JAS12176	3/4-16 x 5 1/2	10	
JAS12192	3/4-16 x 6	10	
JAS12208	3/4-16 x 6 1/2	10	
JAS12224	3/4-16 x 7	10	
JAS12240	3/4-16 x 7 1/2	10	
JAS12256	3/4-16 x 8	10	
JAS12288	3/4-16 x 9	10	
JAS12320	3/4-16 x 10	10	
JAS14056	7/8-14 x 1 3/4	15	
JAS14064	7/8-14 x 2	15	
JAS14072	7/8-14 x 2 1/4	15	
JAS14080	7/8-14 x 2 1/2	15	
JAS14088	7/8-14 x 2 3/4	15	

(continued...)

**GRADE 8 HEX CAP SCREW (cont.)**

ZINC YELLOW, UNF -NORTH AMERICAN

Line: 148-07

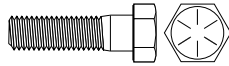
**T9 HEX CAP SCREW**

ZINC YELLOW, UNC - 180M PSI -MADE IN USA

Line: 148-09

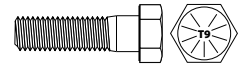

PART NUMBER	SIZE	QTY/BX	LIST PRICE
JAS14096	7/8-14 x 3	15	
JAS14104	7/8-14 x 3 1/4	15	
JAS14112	7/8-14 x 3 1/2	15	
JAS14120	7/8-14 x 3 3/4	15	
JAS14128	7/8-14 x 4	15	
JAS14144	7/8-14 x 4 1/2	10	
JAS14160	7/8-14 x 5	10	
JAS14176	7/8-14 x 5 1/2	10	
JAS14192	7/8-14 x 6	10	
JAS14208	7/8-14 x 6 1/2	10	
JAS14224	7/8-14 x 7	10	
JAS14240	7/8-14 x 7 1/2	10	
JAS14256	7/8-14 x 8	10	
JAS14272	7/8-14 x 8 1/2	10	
JAS14288	7/8-14 x 9	10	
JAS14320	7/8-14 x 10	10	
JAS16064	1-14 x 2	10	
JAS16072	1-14 x 2 1/4	10	
JAS16080	1-14 x 2 1/2	10	
JAS16088	1-14 x 2 3/4	10	
JAS16096	1-14 x 3	10	
JAS16104	1-14 x 3 1/4	10	
JAS16112	1-14 x 3 1/2	10	
JAS16128	1-14 x 4	10	
JAS16144	1-14 x 4 1/2	10	
JAS16160	1-14 x 5	10	
JAS16176	1-14 x 5 1/2	10	
JAS16192	1-14 x 6	10	
JAS16208	1-14 x 6 1/2	10	
JAS16224	1-14 x 7	10	
JAS16240	1-14 x 7 1/2	5	
JAS16256	1-14 x 8	5	
JAS16288	1-14 x 9	5	
JAS16320	1-14 x 10	5	

PART NUMBER	SIZE	QTY/BX	LIST PRICE
ACD04016	1/4-20 x 1/2	100	
ACD04024	1/4-20 x 3/4	100	
ACD04032	1/4-20 x 1	100	
ACD04040	1/4-20 x 1 1/4	100	
ACD04048	1/4-20 x 1 1/2	100	
ACD04056	1/4-20 x 1 3/4	100	
ACD04064	1/4-20 x 2	100	
ACD04072	1/4-20 x 2 1/4	50	
ACD04080	1/4-20 x 2 1/2	50	
ACD04088	1/4-20 x 2 3/4	50	
ACD04096	1/4-20 x 3	50	
ACD04112	1/4-20 x 3 1/2	50	
ACD04128	1/4-20 x 4	50	
ACD04160	1/4-20 x 5	50	
ACD04192	1/4-20 x 6	50	
ACD05016	5/16-18 x 1/2	100	
ACD05020	5/16-18 x 5/8	100	
ACD05024	5/16-18 x 3/4	100	
ACD05032	5/16-18 x 1	100	
ACD05040	5/16-18 x 1 1/4	100	
ACD05048	5/16-18 x 1 1/2	100	
ACD05056	5/16-18 x 1 3/4	100	
ACD05064	5/16-18 x 2	100	
ACD05072	5/16-18 x 2 1/4	50	
ACD05080	5/16-18 x 2 1/2	50	
ACD05088	5/16-18 x 2 3/4	50	
ACD05096	5/16-18 x 3	50	
ACD05112	5/16-18 x 3 1/2	50	
ACD05128	5/16-18 x 4	50	
ACD05160	5/16-18 x 5	50	
ACD06024	3/8-16 x 3/4	100	
ACD06032	3/8-16 x 1	100	
ACD06040	3/8-16 x 1 1/4	100	
ACD06048	3/8-16 x 1 1/2	100	
ACD06056	3/8-16 x 1 3/4	50	
ACD06064	3/8-16 x 2	50	
ACD06072	3/8-16 x 2 1/4	50	
ACD06080	3/8-16 x 2 1/2	50	
ACD06088	3/8-16 x 2 3/4	50	
ACD06096	3/8-16 x 3	50	
ACD06104	3/8-16 x 3 1/4	25	
ACD06112	3/8-16 x 3 1/2	25	
ACD06128	3/8-16 x 4	25	
ACD06144	3/8-16 x 4 1/2	25	

(continued...)

**T9 HEX CAP SCREW (cont.)**

ZINC YELLOW, UNC - 180M PSI-MADE IN USA

Line: 148-09

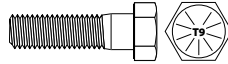

PART NUMBER	SIZE	QTY/BX	LIST PRICE
ACD06160	3/8-16 x 5	25	
ACD06176	3/8-16 x 5 1/2	25	
ACD06192	3/8-16 x 6	25	
ACD07024	7/16-14 x 3/4	50	
ACD07032	7/16-14 x 1	50	
ACD07040	7/16-14 x 1 1/4	50	
ACD07048	7/16-14 x 1 1/2	50	
ACD07056	7/16-14 x 1 3/4	50	
ACD07064	7/16-14 x 2	50	
ACD07072	7/16-14 x 2 1/4	25	
ACD07080	7/16-14 x 2 1/2	25	
ACD07088	7/16-14 x 2 3/4	25	
ACD07096	7/16-14 x 3	25	
ACD07104	7/16-14 x 3 1/4	25	
ACD07112	7/16-14 x 3 1/2	25	
ACD07128	7/16-14 x 4	25	
ACD07144	7/16-14 x 4 1/2	25	
ACD07160	7/16-14 x 5	25	
ACD07176	7/16-14 x 5 1/2	25	
ACD07192	7/16-14 x 6	25	
ACD08024	1/2-13 x 3/4	50	
ACD08032	1/2-13 x 1	50	
ACD08040	1/2-13 x 1 1/4	50	
ACD08048	1/2-13 x 1 1/2	50	
ACD08056	1/2-13 x 1 3/4	50	
ACD08064	1/2-13 x 2	50	
ACD08072	1/2-13 x 2 1/4	25	
ACD08080	1/2-13 x 2 1/2	25	
ACD08088	1/2-13 x 2 3/4	25	
ACD08096	1/2-13 x 3	25	
ACD08104	1/2-13 x 3 1/4	25	
ACD08112	1/2-13 x 3 1/2	25	
ACD08128	1/2-13 x 4	25	
ACD08144	1/2-13 x 4 1/2	25	
ACD08160	1/2-13 x 5	25	
ACD08176	1/2-13 x 5 1/2	25	
ACD08192	1/2-13 x 6	25	
ACD08208	1/2-13 x 6 1/2	25	
ACD08224	1/2-13 x 7	25	
ACD08256	1/2-13 x 8	25	
ACD09040	9/16-12 x 1 1/4	25	
ACD09048	9/16-12 x 1 1/2	25	
ACD09056	9/16-12 x 1 3/4	25	
ACD09064	9/16-12 x 2	25	

**T9 HEX CAP SCREW (cont.)**

ZINC YELLOW, UNC - 180M PSI-MADE IN USA

Line: 148-09

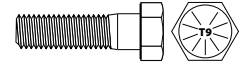

PART NUMBER	SIZE	QTY/BX	LIST PRICE
ACD09080	9/16-12 x 2 1/2	25	
ACD09096	9/16-12 x 3	25	
ACD09112	9/16-12 x 3 1/2	25	
ACD09128	9/16-12 x 4	25	
ACD10040	5/8-11 x 1 1/4	25	
ACD10048	5/8-11 x 1 1/2	25	
ACD10056	5/8-11 x 1 3/4	25	
ACD10064	5/8-11 x 2	25	
ACD10072	5/8-11 x 2 1/4	25	
ACD10080	5/8-11 x 2 1/2	25	
ACD10088	5/8-11 x 2 3/4	25	
ACD10096	5/8-11 x 3	25	
ACD10104	5/8-11 x 3 1/4	25	
ACD10112	5/8-11 x 3 1/2	25	
ACD10128	5/8-11 x 4	25	
ACD10144	5/8-11 x 4 1/2	25	
ACD10160	5/8-11 x 5	25	
ACD10176	5/8-11 x 5 1/2	25	
ACD10192	5/8-11 x 6	25	
ACD10208	5/8-11 x 6 1/2	25	
ACD10224	5/8-11 x 7	25	
ACD10256	5/8-11 x 8	25	
ACD10288	5/8-11 x 9	10	
ACD10320	5/8-11 x 10	10	
ACD12048	3/4-10 x 1 1/2	25	
ACD12056	3/4-10 x 1 3/4	25	
ACD12064	3/4-10 x 2	25	
ACD12072	3/4-10 x 2 1/4	25	
ACD12080	3/4-10 x 2 1/2	25	
ACD12088	3/4-10 x 2 3/4	25	
ACD12096	3/4-10 x 3	25	
ACD12112	3/4-10 x 3 1/2	25	
ACD12128	3/4-10 x 4	25	
ACD12144	3/4-10 x 4 1/2	10	
ACD12160	3/4-10 x 5	10	
ACD12176	3/4-10 x 5 1/2	10	
ACD12192	3/4-10 x 6	10	
ACD12208	3/4-10 x 6 1/2	10	
ACD12224	3/4-10 x 7	10	
ACD12240	3/4-10 x 7 1/2	10	
ACD12256	3/4-10 x 8	10	
ACD12288	3/4-10 x 9	10	
ACD12320	3/4-10 x 10	10	
ACD12384	3/4-10 x 12	10	

(continued...)

**T9 HEX CAP SCREW (cont.)**

ZINC YELLOW, UNC - 180M PSI -MADE IN USA

Line: 148-09

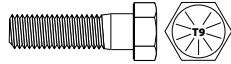
**T9 HEX CAP SCREW**

ZINC YELLOW, UNF - 180M PSI -MADE IN USA

Line: 148-10

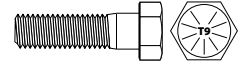

PAGE 3-40

CAP SCREWS - SECTION 03

PART NUMBER	SIZE	QTY/BX	LIST PRICE
ACD14064	7/8-9 x 2	15	
ACD14080	7/8-9 x 2 1/2	15	
ACD14096	7/8-9 x 3	15	
ACD14112	7/8-9 x 3 1/2	15	
ACD14128	7/8-9 x 4	15	
ACD14144	7/8-9 x 4 1/2	10	
ACD14160	7/8-9 x 5	10	
ACD14176	7/8-9 x 5 1/2	10	
ACD14192	7/8-9 x 6	10	
ACD14224	7/8-9 x 7	10	
ACD14256	7/8-9 x 8	10	
ACD14288	7/8-9 x 9	10	
ACD14320	7/8-9 x 10	10	
ACD14384	7/8-9 x 12	10	
ACD16064	1-8 x 2	10	
ACD16080	1-8 x 2 1/2	10	
ACD16096	1-8 x 3	10	
ACD16112	1-8 x 3 1/2	10	
ACD16128	1-8 x 4	10	
ACD16144	1-8 x 4 1/2	10	
ACD16160	1-8 x 5	10	
ACD16176	1-8 x 5 1/2	10	
ACD16192	1-8 x 6	10	
ACD16224	1-8 x 7	10	
ACD16256	1-8 x 8	5	
ACD16288	1-8 x 9	5	
ACD16320	1-8 x 10	5	
ACD18096	1 1/8-7 x 3	5	
ACD18112	1 1/8-7 x 3 1/2	5	
ACD18128	1 1/8-7 x 4	5	
ACD18144	1 1/8-7 x 4 1/2	5	
ACD18160	1 1/8-7 x 5	5	
ACD18176	1 1/8-7 x 5 1/2	5	
ACD18192	1 1/8-7 x 6	5	
ACD18256	1 1/8-7 x 8	5	
ACD18288	1 1/8-7 x 9	5	
ACD18320	1 1/8-7 x 10	5	
ACD20112	1 1/4-7 x 3 1/2	5	
ACD20128	1 1/4-7 x 4	5	
ACD20160	1 1/4-7 x 5	5	
ACD20192	1 1/4-7 x 6	5	
ACD20224	1 1/4-7 x 7	5	
ACD20256	1 1/4-7 x 8	5	
ACD20288	1 1/4-7 x 9	5	
ACD20320	1 1/4-7 x 10	5	

PART NUMBER	SIZE	QTY/BX	LIST PRICE
ACE04016	1/4-28 x 1/2	100	
ACE04024	1/4-28 x 3/4	100	
ACE04032	1/4-28 x 1	100	
ACE04040	1/4-28 x 1 1/4	100	
ACE04048	1/4-28 x 1 1/2	100	
ACE04064	1/4-28 x 2	100	
ACE04080	1/4-28 x 2 1/2	50	
ACE04096	1/4-28 x 3	50	
ACE05024	5/16-24 x 3/4	100	
ACE05032	5/16-24 x 1	100	
ACE05040	5/16-24 x 1-1/4	100	
ACE05048	5/16-24 x 1 1/2	100	
ACE05056	5/16-24 x 1 3/4	100	
ACE05064	5/16-24 x 2	100	
ACE05080	5/16-24 x 2 1/2	50	
ACE05096	5/16-24 x 3	50	
ACE05112	5/16-24 x 3 1/2	50	
ACE05128	5/16-24 x 4	50	
ACE06024	3/8-24 x 3/4	100	
ACE06032	3/8-24 x 1	100	
ACE06040	3/8-24 x 1 1/4	100	
ACE06048	3/8-24 x 1 1/2	100	
ACE06056	3/8-24 x 1 3/4	50	
ACE06064	3/8-24 x 2	50	
ACE06072	3/8-24 x 2 1/4	50	
ACE06080	3/8-24 x 2 1/2	50	
ACE06096	3/8-24 x 3	50	
ACE06112	3/8-24 x 3 1/2	25	
ACE06128	3/8-24 x 4	25	
ACE07032	7/16-20 x 1	50	
ACE07040	7/16-20 x 1 1/4	50	
ACE07048	7/16-20 x 1 1/2	50	
ACE07056	7/16-20 x 1 3/4	50	
ACE07064	7/16-20 x 2	50	
ACE07080	7/16-20 x 2 1/2	25	
ACE07096	7/16-20 x 3	25	
ACE07112	7/16-20 x 3 1/2	25	
ACE07128	7/16-20 x 4	25	
ACE08032	1/2-20 x 1	50	
ACE08040	1/2-20 x 1 1/4	50	
ACE08048	1/2-20 x 1 1/2	50	
ACE08056	1/2-20 x 1 3/4	50	
ACE08064	1/2-20 x 2	50	
ACE08072	1/2-20 x 2 1/4	25	

(continued...)



**T9 HEX CAP SCREW (cont.)**

ZINC YELLOW, UNF - 180M PSI-MADE IN USA

Line: 148-10

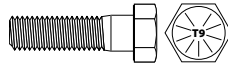

PART NUMBER	SIZE	QTY/BX	LIST PRICE
ACE08080	1/2-20 x 2 1/2	25	
ACE08088	1/2-20 x 2 3/4	25	
ACE08096	1/2-20 x 3	25	
ACE08112	1/2-20 x 3 1/2	25	
ACE08128	1/2-20 x 4	25	
ACE08144	1/2-20 x 4 1/2	25	
ACE08160	1/2-20 x 5	25	
ACE08192	1/2-20 x 6	25	
ACE08224	1/2-20 x 7	25	
ACE08256	1/2-20 x 8	25	
ACE09048	9/16-18 x 1 1/2	25	
ACE09056	9/16-18 x 1 3/4	25	
ACE09064	9/16-18 x 2	25	
ACE09080	9/16-18 x 2 1/2	25	
ACE09096	9/16-18 x 3	25	
ACE09112	9/16-18 x 3 1/2	25	
ACE09128	9/16-18 x 4	25	
ACE09160	9/16-18 x 5	25	
ACE09192	9/16-18 x 6	25	
ACE10040	5/8-18 x 1 1/4	25	
ACE10048	5/8-18 x 1 1/2	25	
ACE10056	5/8-18 x 1 3/4	25	
ACE10064	5/8-18 x 2	25	
ACE10072	5/8-18 x 2 1/4	25	
ACE10080	5/8-18 x 2 1/2	25	
ACE10088	5/8-18 x 2 3/4	25	
ACE10096	5/8-18 x 3	25	
ACE10104	5/8-18 x 3 1/4	25	
ACE10112	5/8-18 x 3 1/2	25	
ACE10128	5/8-18 x 4	25	
ACE10144	5/8-18 x 4 1/2	25	
ACE10160	5/8-18 x 5	25	
ACE10176	5/8-18 x 5 1/2	25	
ACE10192	5/8-18 x 6	25	
ACE10224	5/8-18 x 7	25	
ACE10256	5/8-18 x 8	25	
ACE12048	3/4-16 x 1 1/2	25	
ACE12056	3/4-16 x 1 3/4	25	
ACE12064	3/4-16 x 2	25	
ACE12072	3/4-16 x 2 1/4	25	
ACE12080	3/4-16 x 2 1/2	25	
ACE12088	3/4-16 x 2 3/4	25	
ACE12096	3/4-16 x 3	25	
ACE12112	3/4-16 x 3 1/2	25	

(continued...)

**T9 HEX CAP SCREW (cont.)**

ZINC YELLOW, UNF - 180M PSI-MADE IN USA

Line: 148-10

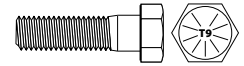

PART NUMBER	SIZE	QTY/BX	LIST PRICE
ACE12128	3/4-16 x 4	25	
ACE12144	3/4-16 x 4 1/2	10	
ACE12160	3/4-16 x 5	10	
ACE12176	3/4-16 x 5 1/2	10	
ACE12192	3/4-16 x 6	10	
ACE12224	3/4-16 x 7	10	
ACE12256	3/4-16 x 8	10	
ACE12288	3/4-16 x 9	10	
ACE14048	7/8-14 x 1 1/2	15	
ACE14064	7/8-14 x 2	15	
ACE14088	7/8-14 x 2 3/4	15	
ACE14096	7/8-14 x 3	15	
ACE14112	7/8-14 x 3 1/2	15	
ACE14128	7/8-14 x 4	15	
ACE14144	7/8-14 x 4 1/2	10	
ACE14160	7/8-14 x 5	10	
ACE14176	7/8-14 x 5 1/2	10	
ACE14192	7/8-14 x 6	10	
ACE14208	7/8-14 x 6 1/2	10	
ACE14224	7/8-14 x 7	10	
ACE14256	7/8-14 x 8	10	
ACE14288	7/8-14 x 9	10	
ACE14320	7/8-14 x 10	10	
ACE16064	1-14 x 2	10	
ACE16080	1-14 x 2 1/2	10	
ACE16096	1-14 x 3	10	
ACE16112	1-14 x 3 1/2	10	
ACE16128	1-14 x 4	10	
ACE16144	1-14 x 4 1/2	10	
ACE16160	1-14 x 5	10	
ACE16176	1-14 x 5 1/2	10	
ACE16192	1-14 x 6	10	
ACE16208	1-14 x 6 1/2	10	
ACE16224	1-14 x 7	10	
ACE16256	1-14 x 8	5	
ACE16288	1-14 x 9	5	
ACE16320	1-14 x 10	5	
ACE18096	1 1/8-12 x 3	5	
ACE18112	1 1/8-12 x 3 1/2	5	
ACE18128	1 1/8-12 x 4	5	
ACE18144	1 1/8-12 x 4 1/2	5	
ACE18160	1 1/8-12 x 5	5	
ACE18176	1 1/8-12 x 5 1/2	5	
ACE18192	1 1/8-12 x 6	5	

(continued...)

**T9 HEX CAP SCREW (cont.)**

ZINC YELLOW, UNF - 180M PSI -MADE IN USA

Line: 148-10

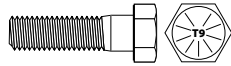

PART NUMBER	SIZE	QTY/BX	LIST PRICE
ACE18224	1 1/8-12 x 7	5	
ACE18256	1 1/8-12 x 8	5	
ACE18288	1 1/8-12 x 9	5	
ACE18320	1 1/8-12 x 10	5	
ACE20096	1 1/4-12 x 3	5	
ACE20112	1 1/4-12 x 3 1/2	5	
ACE20128	1 1/4-12 x 4	5	
ACE20144	1 1/4-12 x 4 1/2	5	
ACE20160	1 1/4-12 x 5	5	
ACE20176	1 1/4-12 x 5 1/2	5	
ACE20192	1 1/4-12 x 6	5	
ACE20224	1 1/4-12 x 7	5	
ACE20256	1 1/4-12 x 8	5	
ACE20288	1 1/4-12 x 9	5	
ACE20320	1 1/4-12 x 10	5	

**HEX MACHINE BOLT**

PLAIN STEEL, UNC

Line: 149-00

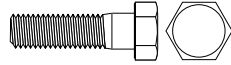

PART NUMBER	SIZE	QTY/BX	LIST PRICE
CRA06272	3/8-16 x 8 1/2	25	
CRA06288	3/8-16 x 9	25	
CRA06320	3/8-16 x 10	25	
CRA06336X	3/8-16 x 10 1/2	25	
CRA06384	3/8-16 x 12	25	
CRA08272	1/2-13 x 8 1/2	25	
CRA08288	1/2-13 x 9	25	
CRA08304	1/2-13 x 9 1/2	25	
CRA08320	1/2-13 x 10	25	
CRA08352	1/2-13 x 11	25	
CRA08384	1/2-13 x 12	25	
CRA08416	1/2-13 x 13	10	
CRA08448	1/2-13 x 14	10	
CRA08480	1/2-13 x 15	10	
CRA08512	1/2-13 x 16	10	
CRA08576	1/2-13 x 18	10	
CRA08640	1/2-13 x 20	10	
CRA10208	5/8-11 x 6 1/2	25	
CRA10272	5/8-11 x 8 1/2	25	
CRA10288	5/8-11 x 9	25	
CRA10304	5/8-11 x 9 1/2	20	
CRA10320	5/8-11 x 10	1	
CRA10336	5/8-11 x 10 1/2	20	
CRA10352	5/8-11 x 11	20	
CRA10384	5/8-11 x 12	50	

(continued...)

**HEX MACHINE BOLT (cont.)**

PLAIN STEEL, UNC

Line: 149-00

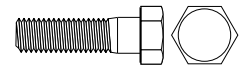

PART NUMBER	SIZE	QTY/BX	LIST PRICE
CRA10416	5/8-11 x 13	1	
CRA10448	5/8-11 x 14	10	
CRA10480	5/8-11 x 15	5	
CRA10512	5/8-11 x 16	1	
CRA10576	5/8-11 x 18	1	
CRA10640	5/8-11 x 20	1	
CRA12272	3/4-10 x 8 1/2	20	
CRA12288	3/4-10 x 9	10	
CRA12304	3/4-10 x 9 1/2	10	
CRA12320	3/4-10 x 10	10	
CRA12352	3/4-10 x 11	10	
CRA12384	3/4-10 x 12	10	
CRA12416	3/4-10 x 13	1	
CRA12448	3/4-10 x 14	1	
CRA12480	3/4-10 x 15	1	
CRA12512	3/4-10 x 16	10	
CRA12576	3/4-10 x 18	1	
CRA12608	3/4-10 x 19	1	
CRA12640	3/4-10 x 20	1	
CRA12768	3/4-10 x 24	1	
CRA14272	7/8-9 x 8 1/2	10	
CRA14288	7/8-9 x 9	1	
CRA14320	7/8-9 x 10	10	
CRA14352	7/8-9 x 11	10	
CRA14384	7/8-9 x 12	10	
CRA14416	7/8-9 x 13	1	
CRA14448	7/8-9 x 14	1	
CRA14512	7/8-9 x 16	1	
CRA14576	7/8-9 x 18	1	
CRA14640	7/8-9 x 20	1	
CRA16288	1-8 x 9	10	
CRA16320	1-8 x 10	10	
CRA16352	1-8 x 11	10	
CRA16384	1-8 x 12	10	
CRA16416	1-8 x 13	1	
CRA16448	1-8 x 14	5	
CRA16480	1-8 x 15	1	
CRA16512	1-8 x 16	1	
CRA16576	1-8 x 18	1	
CRA18112	1 1/8-7 x 3 1/2	15	
CRA18128	1 1/8-7 x 4	15	
CRA18144	1 1/8-7 x 4 1/2	15	
CRA18160	1 1/8-7 x 5	15	
CRA18176	1 1/8-7 x 5 1/2	15	

(continued...)

**HEX MACHINE BOLT** (cont.)

PLAIN STEEL, UNC

Line: 149-00

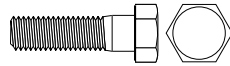

PART NUMBER	SIZE	QTY/BX	LIST PRICE
CRA18192	1 1/8-7 x 6	15	
CRA18224	1 1/8-7 x 7	10	
CRA18256	1 1/8-7 x 8	10	
CRA18288	1 1/8-7 x 9	10	
CRA18320	1 1/8-7 x 10	10	
CRA18352	1 1/8-7 x 11	1	
CRA18384	1 1/8-7 x 12	10	
CRA18512	1 1/8-7 x 16	1	
CRA20096	1 1/4-7 x 3	10	
CRA20112	1 1/4-7 x 3 1/2	10	
CRA20128	1 1/4-7 x 4	10	
CRA20144	1 1/4-7 x 4 1/2	10	
CRA20160	1 1/4-7 x 5	10	
CRA20176	1 1/4-7 x 5 1/2	10	
CRA20192	1 1/4-7 x 6	10	
CRA20208X	1 1/4-7 x 6 1/2	1	
CRA20224	1 1/4-7 x 7	1	
CRA20240	1 1/4-7 x 7 1/2	1	
CRA20256	1 1/4-7 x 8	1	
CRA20272	1 1/4-7 x 8 1/2	1	
CRA20288	1 1/4-7 x 9	1	
CRA20320	1 1/4-7 x 10	1	
CRA20352	1 1/4-7 x 11	1	
CRA20384	1 1/4-7 x 12	1	
CRA20448	1 1/4-7 x 14	1	
CRA20480	1 1/4-7 x 15	1	
CRA20512	1 1/4-7 x 16	1	
CRA24128	1 1/2-6 x 4	1	
CRA24144	1 1/2-6 x 4 1/2	1	
CRA24160	1 1/2-6 x 5	1	
CRA24176	1 1/2-6 x 5 1/2	1	
CRA24192	1 1/2-6 x 6	1	
CRA24224	1 1/2-6 x 7	1	
CRA24240	1 1/2-6 x 7 1/2	1	
CRA24256	1 1/2-6 x 8	1	
CRA24288	1 1/2-6 x 9	1	
CRA24320	1 1/2-6 x 10	1	
CRA24344X	1 1/2-6 x 10 3/4	1	
CRA24352	1 1/2-6 x 11	1	
CRA24384	1 1/2-6 x 12	1	
CRA24408X	1 1/2-6 x 12 3/4	1	
CRA28128	1 3/4-5 x 4	1	
CRA28144	1 3/4-5 x 4 1/2	1	
CRA28160X	1 3/4-5 x 5	1	
CRA28192	1 3/4-5 x 6	1	

**GRADE 5 HEX CAP SCREW**

PLAIN STEEL, UNC - HOT FORGED

Line: 150-00

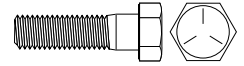

PART NUMBER	SIZE	QTY/BX	LIST PRICE
DEA10384	5/8-11 x 12	1	
DEA10416	5/8-11 x 13	1	
DEA10448	5/8-11 x 14	1	
DEA10480	5/8-11 x 15	1	
DEA12416	3/4-10 x 13	1	
DEA12512	3/4-10 x 16	1	
DEA14352	7/8-9 x 11	1	
DEA14416	7/8-9 x 13	1	
DEA16384	1-8 x 12	1	
DEA16512	1-8 x 16	1	
DEA20384	1 1/4-7 x 12	1	
DEA22096	1 3/8-6 x 3	1	
DEA22128	1 3/8-6 x 4	1	
DEA22160	1 3/8-6 x 5	1	
DEA22192	1 3/8-6 x 6	1	
DEA24080	1 1/2-6 x 2 1/2	1	
DEA24112	1 1/2-6 x 3 1/2	1	
DEA24128	1 1/2-6 x 4	1	
DEA24144	1 1/2-6 x 4 1/2	1	
DEA24160	1 1/2-6 x 5	1	
DEA24176	1 1/2-6 x 5 1/2	1	
DEA24192	1 1/2-6 x 6	1	
DEA24208	1 1/2-6 x 6 1/2	1	
DEA24224	1 1/2-6 x 7	1	
DEA24240	1 1/2-6 x 7 1/2	1	
DEA24256	1 1/2-6 x 8	1	
DEA24320	1 1/2-6 x 10	1	
DEA28160	1 3/4-5 x 5	1	
DEA32288	2-4 1/2 x 9	1	

## GRADE 8 HEX CAP SCREW (cont.)

PLAIN STEEL, UNC - HOT FORGED

Line: 151-00

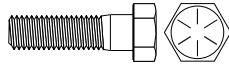

PART NUMBER	SIZE	QTY/BX	LIST PRICE
DFA14448	7/8-9 x 14	1	
DFA16480	1-8 x 15	1	
DFA18352	1 1/8-7 x 11	1	
DFA18384	1 1/8-7 x 12	1	
DFA20352	1 1/4-7 x 11	1	
DFA22128	1 3/8-6 x 4	1	
DFA22160	1 3/8-6 x 5	1	
DFA22192	1 3/8-6 x 6	1	
DFA22208	1 3/8-6 x 6 1/2	1	
DFA22224	1 3/8-6 x 7	1	
DFA22256	1 3/8-6 x 8	1	
DFA22384	1 3/8-6 x 12	1	
DFA24112	1 1/2-6 x 3 1/2	1	
DFA24128	1 1/2-6 x 4	1	
DFA24144	1 1/2-6 x 4 1/2	1	
DFA24160	1 1/2-6 x 5	1	
DFA24192	1 1/2-6 x 6	1	
DFA24224	1 1/2-6 x 7	1	
DFA24256	1 1/2-6 x 8	1	
DFA24320	1 1/2-6 x 10	1	
DFA24352	1 1/2-6 x 11	1	
DFA28128X	1 3/4-5 x 4	1	
DFA28160	1 3/4-5 x 5	1	
DFA28192	1 3/4-5 x 6	1	
DFA28256	1 3/4-5 x 8	1	
DFA28512	1 3/4-5 x 16	1	
DFA28704	1 3/4-5 x 22	1	
DFA32240	2-4 1/2 x 7 1/2	1	
DFA32256	2-4 1/2 x 8	1	

## A325 STRUCTURAL BOLT

PLAIN STEEL, UNC - INCLUDES NUTS

Line: 152-00

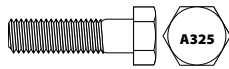

PART NUMBER	SIZE	QTY/BX	LIST PRICE
DJA08048	1/2-13 x 1 1/2	1	
DJA08064	1/2-13 x 2	1	
DJA08112X	1/2-13 x 3 1/2	1	
DJA08128	1/2-13 x 4	1	
DJA10040	5/8-11 x 1 1/4	1	
DJA10048	5/8-11 x 1 1/2	1	
DJA10056	5/8-11 x 1 3/4	1	
DJA10064	5/8-11 x 2	1	
DJA10072	5/8-11 x 2 1/4	1	
DJA10080	5/8-11 x 2 1/2	1	
DJA10088	5/8-11 x 2 3/4	1	

(continued...)

## A325 STRUCTURAL BOLT (cont.)

PLAIN STEEL, UNC - INCLUDES NUTS

Line: 152-00

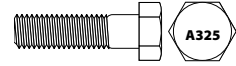

PART NUMBER	SIZE	QTY/BX	LIST PRICE
DJA10096	5/8-11 x 3	1	
DJA10104	5/8-11 x 3 1/4	1	
DJA10112	5/8-11 x 3 1/2	1	
DJA10120	5/8-11 x 3 3/4	1	
DJA10128	5/8-11 x 4	1	
DJA10144	5/8-11 x 4 1/2	1	
DJA10160	5/8-11 x 5	1	
DJA10176	5/8-11 x 5 1/2	1	
DJA10192	5/8-11 x 6	1	
DJA10384	5/8-11 x 12	1	
DJA12048	3/4-10 x 1 1/2	1	
DJA12056	3/4-10 x 1 3/4	1	
DJA12064	3/4-10 x 2	1	
DJA12072	3/4-10 x 2 1/4	1	
DJA12080	3/4-10 x 2 1/2	1	
DJA12088	3/4-10 x 2 3/4	1	
DJA12096	3/4-10 x 3	1	
DJA12104	3/4-10 x 3 1/4	1	
DJA12112	3/4-10 x 3 1/2	1	
DJA12120	3/4-10 x 3 3/4	1	
DJA12128	3/4-10 x 4	1	
DJA12136	3/4-10 x 4 1/4	1	
DJA12144	3/4-10 x 4 1/2	1	
DJA12160	3/4-10 x 5	1	
DJA12176	3/4-10 x 5 1/2	1	
DJA12192	3/4-10 x 6	1	
DJA12208	3/4-10 x 6 1/2	1	
DJA12224	3/4-10 x 7	1	
DJA12240	3/4-10 x 7 1/2	1	
DJA12256	3/4-10 x 8	1	
DJA14064	7/8-9 x 2	1	
DJA14072	7/8-9 x 2 1/4	1	
DJA14080	7/8-9 x 2 1/2	1	
DJA14088	7/8-9 x 2 3/4	1	
DJA14096	7/8-9 x 3	1	
DJA14104	7/8-9 x 3 1/4	1	
DJA14112	7/8-9 x 3 1/2	1	
DJA14120	7/8-9 x 3 3/4	1	
DJA14128	7/8-9 x 4	1	
DJA14136	7/8-9 x 4 1/4	1	
DJA14144	7/8-9 x 4 1/2	1	
DJA14152	7/8-9 x 4 3/4	1	
DJA14160	7/8-9 x 5	1	
DJA14176	7/8-9 x 5 1/2	1	

(continued...)

**A325 STRUCTURAL BOLT (cont.)**PLAIN STEEL, UNC - **INCLUDES NUTS**

Line: 152-00

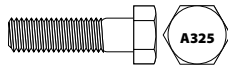

PART NUMBER	SIZE	QTY/BX	LIST PRICE
DJA14184X	7/8-9 x 5 3/4	1	
DJA14192	7/8-9 x 6	1	
DJA14208	7/8-9 x 6 1/2	1	
DJA14224	7/8-9 x 7	1	
DJA14240	7/8-9 x 7 1/2	1	
DJA14256	7/8-9 x 8	1	
DJA14272X	7/8-9 x 8 1/2	1	
DJA16096	1-8 x 3	1	
DJA16112	1-8 x 3 1/2	1	
DJA16120	1-8 x 3 3/4	1	
DJA16128	1-8 x 4	1	
DJA16136	1-8 x 4 1/4	1	
DJA16144	1-8 x 4 1/2	1	
DJA16152	1-8 x 4 3/4	1	
DJA16160	1-8 x 5	1	
DJA16168	1-8 x 5 1/4	1	
DJA16176	1-8 x 5 1/2	1	
DJA16192	1-8 x 6	1	
DJA16208	1-8 x 6 1/2	1	
DJA16224	1-8 x 7	1	
DJA16240	1-8 x 7 1/2	1	
DJA16256	1-8 x 8	1	
DJA16384	1-8 x 12	1	
DJA18096	1 1/8-7 x 3	1	
DJA18104	1 1/8-7 x 3 1/4	1	
DJA18112	1 1/8-7 x 3 1/2	1	
DJA18120	1 1/8-7 x 3 3/4	1	
DJA18128	1 1/8-7 x 4	1	
DJA18136	1 1/8-7 x 4 1/4	1	
DJA18144	1 1/8-7 x 4 1/2	1	
DJA18152	1 1/8-7 x 4 3/4	1	
DJA18160	1 1/8-7 x 5	1	
DJA18176	1 1/8-7 x 5 1/2	1	
DJA18192	1 1/8-7 x 6	1	
DJA18208	1 1/8-7 x 6 1/2	1	
DJA18224	1 1/8-7 x 7	1	
DJA18240	1 1/8-7 x 7 1/2	1	
DJA18256	1 1/8-7 x 8	1	
DJA18312	1 1/8-7 x 9 3/4	1	
DJA20096	1 1/4-7 x 3	1	
DJA20104	1 1/4-7 x 3 1/4	1	
DJA20112	1 1/4-7 x 3 1/2	1	
DJA20120	1 1/4-7 x 3 3/4	1	
DJA20128	1 1/4-7 x 4	1	

(continued...)

**A325 STRUCTURAL BOLT (cont.)**PLAIN STEEL, UNC - **INCLUDES NUTS**

Line: 152-00

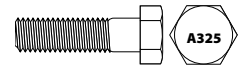

PART NUMBER	SIZE	QTY/BX	LIST PRICE
DJA20136	1 1/4-7 x 4 1/4	1	
DJA20144	1 1/4-7 x 4 1/2	1	
DJA20152	1 1/4-7 x 4 3/4	1	
DJA20160	1 1/4-7 x 5	1	
DJA20176	1 1/4-7 x 5 1/2	1	
DJA20192	1 1/4-7 x 6	1	
DJA20208	1 1/4-7 x 6 1/2	1	
DJA20224	1 1/4-7 x 7	1	
DJA20240	1 1/4-7 x 7 1/2	1	
DJA20256	1 1/4-7 x 8	1	
DJA20288	1 1/4-7 x 9	1	
DJA20320	1 1/4-7 x 10	1	

## A325 STRUCTURAL BOLT

PLAIN STEEL, UNC - BOLT ONLY

Line: 153-00

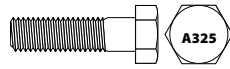

PART NUMBER	SIZE	QTY/BX	LIST PRICE
DLA08040	1/2-13 x 1 1/4	1	
DLA08048	1/2-13 x 1 1/2	1	
DLA08056	1/2-13 x 1 3/4	1	
DLA08064	1/2-13 x 2	1	
DLA08080	1/2-13 x 2 1/2	1	
DLA10048	5/8-11 x 1 1/2	1	
DLA10056	5/8-11 x 1 3/4	1	
DLA10064	5/8-11 x 2	1	
DLA10080	5/8-11 x 2 1/2	1	
DLA10112	5/8-11 x 3 1/2	1	
DLA10128	5/8-11 x 4	1	
DLA10160	5/8-11 x 5	1	
DLA10192	5/8-11 x 6	1	
DLA12048	3/4-10 x 1 1/2	1	
DLA12056	3/4-10 x 1 3/4	1	
DLA12064	3/4-10 x 2	1	
DLA12072	3/4-10 x 2 1/4	1	
DLA12080	3/4-10 x 2 1/2	1	
DLA12088	3/4-10 x 2 3/4	1	
DLA12096	3/4-10 x 3	1	
DLA12112	3/4-10 x 3 1/2	1	
DLA12120	3/4-10 x 3 3/4	1	
DLA12128	3/4-10 x 4	1	
DLA12160	3/4-10 x 5	1	
DLA12176	3/4-10 x 5 1/2	1	
DLA12192	3/4-10 x 6	1	
DLA12256	3/4-10 x 8	1	
DLA14056	7/8-9 x 1 3/4	1	
DLA14088	7/8-9 x 2 3/4	1	
DLA14096	7/8-9 x 3	1	
DLA14112	7/8-9 x 3 1/2	1	
DLA14120	7/8-9 x 3 3/4	1	
DLA14256	7/8-9 x 8	1	
DLA16072	1-8 x 2 1/4	1	
DLA16080	1-8 x 2 1/2	1	
DLA16096	1-8 x 3	1	
DLA16104	1-8 x 3 1/4	1	
DLA16112	1-8 x 3 1/2	1	
DLA16128	1-8 x 4	1	
DLA16144	1-8 x 4 1/2	1	
DLA16160	1-8 x 5	1	
DLA16168	1-8 x 5 1/4	1	
DLA16176	1-8 x 5 1/2	1	
DLA16224	1-8 x 7	1	

## A325 STRUCTURAL BOLT

PLAIN STEEL, UNC - BOLT ONLY

Line: 153-00

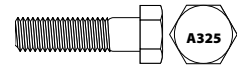

PART NUMBER	SIZE	QTY/BX	LIST PRICE
DLA16384	1-8 x 12	1	
DLA18136	1 1/8-7 x 4 1/4	1	
DLA18144	1 1/8-7 x 4 1/2	1	
DLA18224	1 1/8-7 x 7	1	
DLA20104	1 1/4-7 x 3 1/4	1	
DLA20112	1 1/4-7 x 3 1/2	1	
DLA20120	1 1/4-7 x 3 3/4	1	
DLA20144	1 1/4-7 x 4 1/2	1	
DLA20176	1 1/4-7 x 5 1/2	1	
DLA20192	1 1/4-7 x 6	1	
DLA20208	1 1/4-7 x 6 1/2	1	
DLA20256	1 1/4-7 x 8	1	
DLA20288	1 1/4-7 x 9	1	
DLA20320	1 1/4-7 x 10	1	

## A325 STRUCTURAL BOLT

HOT DIPPED GALVANIZED - BOLT ONLY

Line: 153-01

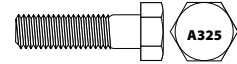

PART NUMBER	SIZE	QTY/BX	LIST PRICE
BBT08048	1/2-13 x 1 1/2	50	
BBT08064	1/2-13 x 2	50	
BBT08080	1/2-13 x 2 1/2	25	
BBT10056	5/8-11 x 1 3/4	25	
BBT10064	5/8-11 x 2	25	
BBT10072	5/8-11 x 2 1/4	25	
BBT10080	5/8-11 x 2 1/2	25	
BBT12064	3/4-10 x 2	25	
BBT12072	3/4-10 x 2 1/4	25	
BBT12080	3/4-10 x 2 1/2	25	
BBT12088	3/4-10 x 2 3/4	25	
BBT12096	3/4-10 x 3	25	
BBT12104	3/4-10 x 3 1/4	25	
BBT12144	3/4-10 x 4 1/2	25	
BBT12192	3/4-10 x 6	10	
BBT12208	3/4-10 x 6 1/2	10	
BBT12224	3/4-10 x 7	10	
BBT12832	3/4-10 x 26 (STHD)	1	
BBT14080	7/8-9 x 2 1/2	1	
BBT14096	7/8-9 x 3	1	
BBT14104	7/8-9 x 3 1/4	1	
BBT16128	1-8 x 4	1	
BBT16144	1-8 x 4 1/2	1	

## A490 STRUCTURAL BOLT

PLAIN STEEL, UNC - INCLUDES NUTS

Line: 154-00

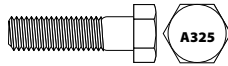

PART NUMBER	SIZE	QTY/BX	LIST PRICE
DKA12064	3/4-10 x 2	1	
DKA12192	3/4-10 x 6	1	
DKA14080	7/8-9 x 2 1/2	1	
DKA14112	7/8-9 x 3 1/2	1	
DKA16104	1-8 x 3 1/4	1	
DKA16112	1-8 x 3 1/2	1	
DKA16120	1-8 x 3 3/4	1	
DKA16128	1-8 x 4	1	
DKA16136	1-8 x 4 1/4	1	
DKA16160	1-8 x 5	1	
DKA18176	1 1/8-7 x 5 1/2	1	

## A193 HEX BOLT (B7)

PLAIN STEEL, UNC

Line: 154-01

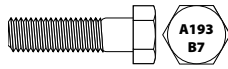

PART NUMBER	SIZE	QTY/BX	LIST PRICE
JBG08040	1/2-13 x 1 1/4	50	
JBG08064X	1/2-13 x 2	50	
JBG08072	1/2-13 x 2 1/4	25	
JBG08080	1/2-13 x 2 1/2	25	
JBG08088	1/2-13 x 2 3/4	25	
JBG08096	1/2-13 x 3	25	
JBG08112	1/2-13 x 3 1/2	25	
JBG08128	1/2-13 x 4	25	
JBG09064	9/16-12 x 2	50	
JBG10040	5/8-11 x 1 1/4	25	
JBG10064	5/8-11 x 2	25	
JBG10080	5/8-11 x 2 1/2	25	
JBG10088X	5/8-11 x 2 3/4	25	
JBG10096	5/8-11 x 3	25	
JBG10112	5/8-11 x 3 1/2	25	
JBG10128	5/8-11 x 4	25	
JBG10144	5/8-11 x 4 1/2	25	
JBG12048	3/4-10 x 1 1/2	25	
JBG12064X	3/4-10 x 2	25	
JBG12072	3/4-10 x 2 1/4	25	
JBG12112	3/4-10 x 3 1/2	25	
JBG12112X	3/4-10 x 3 1/2	25	
JBG12144	3/4-10 x 4 1/2	25	
JBG12160	3/4-10 x 5	25	
JBG14112	7/8-9 x 3 1/2	25	
JBG14120X	7/8-9 x 3-3/4	25	
JBG18104UN8	1 1/8-8 x 3 1/4	5	
JBG20224X	1 1/4-7 x 7	5	
JBG28208	1 3/4-5 x 6 1/2	1	

# SECTION 4 PRODUCT INDEX

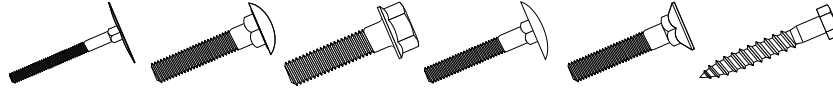

Line Description	Alpha	Line#	Page#
CARRIAGE BOLTS - GRADE 2 - ZINC - UNC	<b>CTA</b>	<b>156-00</b>	4-2
CARRIAGE BOLTS - GRADE 5 - ZINC - UNC	<b>DBA</b>	<b>157-00</b>	4-4
RIBBED NECK CARRIAGE BOLTS - ZINC - UNC	<b>JHK</b>	<b>157-01</b>	4-4
CARRIAGE BOLTS - GRADE 2 - HOT DIPPED GALVANIZED - UNC	<b>ANS</b>	<b>157-03</b>	4-5
TIMBER BOLTS - HOT DIPPED GALVANIZED - UNC	<b>BMM</b>	<b>157-04</b>	4-6
SQUARE MACHINE BOLTS - GRADE 2 - PLAIN FINISH - UNC	<b>CWA</b>	<b>158-00</b>	4-6
STEP BOLTS - GRADE 2 - ZINC PLATED - UNC	<b>CUA</b>	<b>160-00</b>	4-8
ELEVATOR BOLTS - GRADE 2 - ZINC PLATED - UNC	<b>CVA</b>	<b>162-00</b>	4-9
PLOW BOLTS - GRADE 8 - #3 DOME HD YELLOW/ZINC - UNC	<b>DCA</b>	<b>165-00</b>	4-9
PLOW BOLTS - GRADE 5 - #3 FLAT HD ZINC - UNC	<b>EHD</b>	<b>166-00</b>	4-10
HEX FRAME FLANGE BOLT 150K PSI - PLAIN - UNC	<b>JHS</b>	<b>167-05</b>	4-10
HEX FRAME FLANGE BOLT 150K PSI - PLAIN - UNF	<b>JJS</b>	<b>167-06</b>	4-11
HEX FLANGE SERRATED SCREW - GRADE 5 - ZINC - UNC	<b>CAV</b>	<b>167-10</b>	4-11
HANGER BOLTS PLAIN CENTER - PLAIN FINISH	<b>CHB</b>	<b>170-99</b>	4-12
HANGER BOLTS CLOSED CENTER - ZINC	<b>HXA</b>	<b>171-00</b>	4-12
DOWEL SCREW - PLAIN FINISH	<b>ALW</b>	<b>171-01</b>	4-12
ACOUSTICAL SPADE LAG SCREW - ZINC	<b>ALY</b>	<b>171-02</b>	4-13
HEX LAG SCREWS - GRADE 2 - ZINC	<b>HUA</b>	<b>172-00</b>	4-13
HEX LAG SCREWS - GRADE 2 - HOT DIPPED GALVANIZED	<b>ANT</b>	<b>173-01</b>	4-14
A307B HEAVY HEX BOLTS - GRADE 2 - PLAIN	<b>JCD</b>	<b>174-00</b>	4-15



**CALL - 1 (800) 723-2826**



# GRADE 2 CARRIAGE BOLT

ZINC PLATED, UNC

Line: 156-00

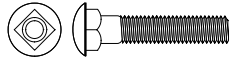

# GRADE 2 CARRIAGE BOLT (cont.)

ZINC PLATED, UNC

Line: 156-00

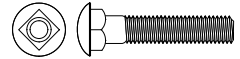

PART NUMBER	SIZE	QTY/BX	LIST PRICE
CTA03016	#10-24 x 1/2	100	
CTA03020X	#10-24 x 5/8	100	
CTA03024	#10-24 x 3/4	100	
CTA03032	#10-24 x 1	100	
CTA03040	#10-24 x 1 1/4	100	
CTA03048	#10-24 x 1 1/2	100	
CTA03056	#10-24 x 1 3/4	100	
CTA03064	#10-24 x 2	100	
CTA03072	#10-24 x 2 1/4	100	
CTA03080	#10-24 x 2 1/2	100	
CTA03096	#10-24 x 3	100	
CTA03112	#10-24 x 3 1/2	100	
CTA03128	#10-24 x 4	100	
CTA04016	1/4-20 x 1/2	100	
CTA04020X	1/4-20 x 5/8	100	
CTA04024	1/4-20 x 3/4	100	
CTA04032	1/4-20 x 1	100	
CTA04040	1/4-20 x 1 1/4	100	
CTA04048	1/4-20 x 1 1/2	100	
CTA04056	1/4-20 x 1 3/4	100	
CTA04064	1/4-20 x 2	100	
CTA04072	1/4-20 x 2 1/4	100	
CTA04080	1/4-20 x 2 1/2	100	
CTA04088	1/4-20 x 2 3/4	100	
CTA04096	1/4-20 x 3	100	
CTA04104	1/4-20 x 3 1/4	50	
CTA04112	1/4-20 x 3 1/2	50	
CTA04120	1/4-20 x 3 3/4	50	
CTA04128	1/4-20 x 4	50	
CTA04144	1/4-20 x 4 1/2	50	
CTA04160	1/4-20 x 5	50	
CTA04176	1/4-20 x 5 1/2	50	
CTA04192	1/4-20 x 6	50	
CTA04208	1/4-20 x 6 1/2	50	
CTA04224	1/4-20 x 7	50	
CTA04240C	1/4-20 x 7 1/2	100	
CTA04256	1/4-20 x 8	50	
CTA05016	5/16-18 x 1/2	100	
CTA05020	5/16-18 x 5/8	100	
CTA05024	5/16-18 x 3/4	100	
CTA05032	5/16-18 x 1	100	
CTA05040	5/16-18 x 1 1/4	100	
CTA05048	5/16-18 x 1 1/2	100	
CTA05056	5/16-18 x 1 3/4	100	

(continued...)

PART NUMBER	SIZE	QTY/BX	LIST PRICE
CTA05064	5/16-18 x 2	100	
CTA05072	5/16-18 x 2 1/4	50	
CTA05080	5/16-18 x 2 1/2	50	
CTA05088	5/16-18 x 2 3/4	50	
CTA05096	5/16-18 x 3	50	
CTA05104	5/16-18 x 3 1/4	50	
CTA05112	5/16-18 x 3 1/2	50	
CTA05120X	5/16-18 x 3 3/4	50	
CTA05128	5/16-18 x 4	50	
CTA05144	5/16-18 x 4 1/2	50	
CTA05160	5/16-18 x 5	50	
CTA05176	5/16-18 x 5 1/2	50	
CTA05192	5/16-18 x 6	50	
CTA05208	5/16-18 x 6 1/2	50	
CTA05224	5/16-18 x 7	50	
CTA05240	5/16-18 x 7 1/2	25	
CTA05256	5/16-18 x 8	50	
CTA05288X	5/16-18 x 9	50	
CTA05320X	5/16-18 x 10	50	
CTA06024	3/8-16 x 3/4	100	
CTA06032	3/8-16 x 1	100	
CTA06040	3/8-16 x 1 1/4	100	
CTA06048	3/8-16 x 1 1/2	100	
CTA06056	3/8-16 x 1 3/4	50	
CTA06064	3/8-16 x 2	50	
CTA06072	3/8-16 x 2 1/4	50	
CTA06080	3/8-16 x 2 1/2	50	
CTA06088	3/8-16 x 2 3/4	50	
CTA06096	3/8-16 x 3	50	
CTA06104	3/8-16 x 3 1/4	50	
CTA06112	3/8-16 x 3 1/2	50	
CTA06120	3/8-16 x 3 3/4	50	
CTA06128	3/8-16 x 4	50	
CTA06144	3/8-16 x 4 1/2	25	
CTA06160	3/8-16 x 5	25	
CTA06176	3/8-16 x 5 1/2	25	
CTA06192	3/8-16 x 6	25	
CTA06208	3/8-16 x 6 1/2	25	
CTA06224	3/8-16 x 7	25	
CTA06240	3/8-16 x 7 1/2	25	
CTA06256	3/8-16 x 8	25	
CTA06272	3/8-16 x 8 1/2	25	
CTA06288	3/8-16 x 9	25	
CTA06304	3/8-16 x 9 1/2	25	

(continued...)

## GRADE 2 CARRIAGE BOLT (cont.)

ZINC PLATED, UNC

Line: 156-00

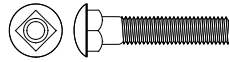

PART NUMBER	SIZE	QTY/BX	LIST PRICE
CTA06320	3/8-16 x 10	25	
CTA06352	3/8-16 x 11	25	
CTA06384	3/8-16 x 12	25	
CTA07032	7/16-14 x 1	50	
CTA07040	7/16-14 x 1 1/4	50	
CTA07048	7/16-14 x 1 1/2	50	
CTA07056	7/16-14 x 1 3/4	50	
CTA07064	7/16-14 x 2	50	
CTA07072	7/16-14 x 2 1/4	25	
CTA07080	7/16-14 x 2 1/2	25	
CTA07088	7/16-14 x 2 3/4	25	
CTA07096	7/16-14 x 3	25	
CTA07112	7/16-14 x 3 1/2	25	
CTA07128	7/16-14 x 4	25	
CTA07144	7/16-14 x 4 1/2	25	
CTA07160	7/16-14 x 5	25	
CTA07176	7/16-14 x 5 1/2	25	
CTA07192	7/16-14 x 6	25	
CTA08032	1/2-13 x 1	50	
CTA08040	1/2-13 x 1 1/4	50	
CTA08048	1/2-13 x 1 1/2	50	
CTA08056	1/2-13 x 1 3/4	50	
CTA08064	1/2-13 x 2	50	
CTA08072	1/2-13 x 2 1/4	50	
CTA08080	1/2-13 x 2 1/2	25	
CTA08088	1/2-13 x 2 3/4	25	
CTA08096	1/2-13 x 3	25	
CTA08104X	1/2-13 x 3 1/4	25	
CTA08112	1/2-13 x 3 1/2	25	
CTA08128	1/2-13 x 4	25	
CTA08144	1/2-13 x 4 1/2	25	
CTA08160	1/2-13 x 5	25	
CTA08176	1/2-13 x 5 1/2	25	
CTA08192	1/2-13 x 6	25	
CTA08208	1/2-13 x 6 1/2	25	
CTA08224	1/2-13 x 7	25	
CTA08240	1/2-13 x 7 1/2	25	
CTA08256	1/2-13 x 8	25	
CTA08272	1/2-13 x 8 1/2	25	
CTA08288	1/2-13 x 9	25	
CTA08304	1/2-13 x 9 1/2	25	
CTA08320	1/2-13 x 10	25	
CTA08352	1/2-13 x 11	25	
CTA08384	1/2-13 x 12	25	

(continued...)

## GRADE 2 CARRIAGE BOLT (cont.)

ZINC PLATED, UNC

Line: 156-00

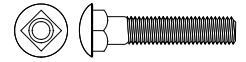

PART NUMBER	SIZE	QTY/BX	LIST PRICE
CTA08416	1/2-13 x 13	25	
CTA08448	1/2-13 x 14	10	
CTA10048	5/8-11 x 1 1/2	25	
CTA10056	5/8-11 x 1 3/4	25	
CTA10064	5/8-11 x 2	25	
CTA10072	5/8-11 x 2 1/4	25	
CTA10080	5/8-11 x 2 1/2	25	
CTA10088	5/8-11 x 2 3/4	25	
CTA10096	5/8-11 x 3	25	
CTA10112	5/8-11 x 3 1/2	25	
CTA10128	5/8-11 x 4	25	
CTA10144	5/8-11 x 4 1/2	25	
CTA10160	5/8-11 x 5	25	
CTA10176	5/8-11 x 5 1/2	25	
CTA10192	5/8-11 x 6	25	
CTA10208	5/8-11 x 6 1/2	25	
CTA10224	5/8-11 x 7	25	
CTA10240	5/8-11 x 7 1/2	25	
CTA10256	5/8-11 x 8	15	
CTA10272	5/8-11 x 8 1/2	15	
CTA10288	5/8-11 x 9	15	
CTA10320	5/8-11 x 10	15	
CTA10352	5/8-11 x 11	15	
CTA10384	5/8-11 x 12	15	
CTA12064	3/4-10 x 2	25	
CTA12080	3/4-10 x 2 1/2	25	
CTA12096	3/4-10 x 3	25	
CTA12112	3/4-10 x 3 1/2	15	
CTA12128	3/4-10 x 4	15	
CTA12144	3/4-10 x 4 1/2	15	
CTA12160	3/4-10 x 5	10	
CTA12176	3/4-10 x 5 1/2	10	
CTA12192	3/4-10 x 6	10	
CTA12208	3/4-10 x 6 1/2	10	
CTA12224	3/4-10 x 7	10	
CTA12240	3/4-10 x 7 1/2	10	
CTA12256	3/4-10 x 8	10	
CTA12288	3/4-10 x 9	10	
CTA12320	3/4-10 x 10	10	
CTA12384	3/4-10 x 12	5	

## GRADE 5 CARRIAGE BOLT

ZINC PLATED, UNC

Line: 157-00

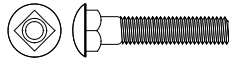

PART NUMBER	SIZE	QTY/BX	LIST PRICE
DBA04024	1/4-20 x 3/4	100	
DBA04032	1/4-20 x 1	100	
DBA04040	1/4-20 x 1 1/4	100	
DBA04048	1/4-20 x 1 1/2	100	
DBA04064	1/4-20 x 2	100	
DBA04080	1/4-20 x 2 1/2	100	
DBA04096	1/4-20 x 3	50	
DBA04112	1/4-20 x 3 1/2	50	
DBA04128	1/4-20 x 4	50	
DBA05024	5/16-18 x 3/4	100	
DBA05032	5/16-18 x 1	100	
DBA05040	5/16-18 x 1 1/4	100	
DBA05048	5/16-18 x 1 1/2	100	
DBA05064	5/16-18 x 2	100	
DBA05072	5/16-18 x 2 1/4	50	
DBA05080	5/16-18 x 2 1/2	50	
DBA05096	5/16-18 x 3	50	
DBA05128	5/16-18 x 4	50	
DBA05192	5/16-18 x 6	50	
DBA06024	3/8-16 x 3/4	100	
DBA06032X	3/8-16 x 1	100	
DBA06040	3/8-16 x 1 1/4	100	
DBA06048X	3/8-16 x 1 1/2	100	
DBA06064	3/8-16 x 2	50	
DBA06072	3/8-16 x 2 1/4	50	
DBA06080	3/8-16 x 2 1/2	50	
DBA06096	3/8-16 x 3	50	
DBA06112	3/8-16 x 3 1/2	50	
DBA06128	3/8-16 x 4	25	
DBA06144	3/8-16 x 4 1/2	25	
DBA06160	3/8-16 x 5	25	
DBA06192	3/8-16 x 6	25	
DBA07040X	7/16-14 x 1 1/4	50	
DBA07048	7/16-14 x 1 1/2	50	
DBA07056	7/16-14 x 1 3/4	50	
DBA07064	7/16-14 x 2	50	
DBA07080	7/16-14 x 2 1/2	50	
DBA07096	7/16-14 x 3	50	
DBA08032	1/2-13 x 1	50	
DBA08040RX	1/2-13 x 1 1/4	50	
DBA08048	1/2-13 x 1 1/2	50	
DBA08056	1/2-13 x 1 3/4	50	
DBA08064	1/2-13 x 2	50	
DBA08080	1/2-13 x 2 1/2	25	

(continued...)

## GRADE 5 CARRIAGE BOLT (cont.)

ZINC PLATED, UNC

Line: 157-00

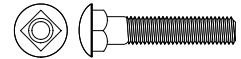

PART NUMBER	SIZE	QTY/BX	LIST PRICE
DBA08096	1/2-13 x 3	25	
DBA08112	1/2-13 x 3 1/2	25	
DBA08128	1/2-13 x 4	25	
DBA08144	1/2-13 x 4 1/2	25	
DBA08160	1/2-13 x 5	25	
DBA08176	1/2-13 x 5 1/2	25	
DBA08192	1/2-13 x 6	25	
DBA10048	5/8-11 x 1 1/2	25	
DBA10064	5/8-11 x 2	25	
DBA10080	5/8-11 x 2 1/2	25	
DBA10096	5/8-11 x 3	25	
DBA10112	5/8-11 x 3 1/2	25	
DBA10128	5/8-11 x 4	25	
DBA10144	5/8-11 x 4 1/2	25	
DBA10160	5/8-11 x 5	25	
DBA10192	5/8-11 x 6	10	
DBA12064	3/4-10 x 2	25	
DBA12080	3/4-10 x 2 1/2	20	
DBA12096	3/4-10 x 3	25	
DBA12112	3/4-10 x 3 1/2	25	
DBA12128	3/4-10 x 4	10	
DBA12144	3/4-10 x 4 1/2	10	
DBA12160	3/4-10 x 5	10	
DBA12176	3/4-10 x 5 1/2	10	
DBA12192	3/4-10 x 6	10	

## RIBBED NECK CARRIAGE BOLT

ZINC PLATED, UNC

Line: 157-01

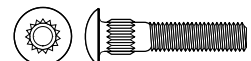

PART NUMBER	SIZE	QTY/BX	LIST PRICE
JHK04032	1/4-20 x 1	100	
JHK04040	1/4-20 x 1 1/4	100	
JHK04048	1/4-20 x 1 1/2	100	
JHK04056	1/4-20 x 1 3/4	100	
JHK04064	1/4-20 x 2	100	
JHK05032X	5/16-18 x 1	100	
JHK05040	5/16-18 x 1 1/4	100	
JHK05048	5/16-18 x 1 1/2	100	
JHK06032GR5	3/8-16 x 1 (Grade 5)	100	
JHK06040	3/8-16 x 1 1/4	100	
JHK06048	3/8-16 x 1 1/2	100	
JHK06064	3/8-16 x 2	50	
JHK06080	3/8-16 x 2 1/2	50	

## GRADE 2 CARRIAGE BOLT

HOT-DIP GALVANIZED, UNC

Line: 157-03

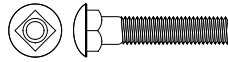

PART NUMBER	SIZE	QTY/BX	LIST PRICE
ANS04024	1/4-20 x 3/4	100	
ANS04032	1/4-20 x 1	100	
ANS04040	1/4-20 x 1 1/4	100	
ANS04048	1/4-20 x 1 1/2	100	
ANS04064	1/4-20 x 2	100	
ANS04072	1/4-20 x 2 1/4	100	
ANS04080	1/4-20 x 2 1/2	100	
ANS04096	1/4-20 x 3	100	
ANS04112	1/4-20 x 3 1/2	50	
ANS04128	1/4-20 x 4	50	
ANS04144	1/4-20 x 4 1/2	50	
ANS04160	1/4-20 x 5	50	
ANS04176	1/4-20 x 5 1/2	50	
ANS04192	1/4-20 x 6	50	
ANS04208C	1/4-20 x 6 1/2	100	
ANS04224	1/4-20 x 7	50	
ANS04256	1/4-20 x 8	50	
ANS05024	5/16-18 x 3/4	100	
ANS05032	5/16-18 x 1	100	
ANS05040	5/16-18 x 1 1/4	100	
ANS05048	5/16-18 x 1 1/2	100	
ANS05064	5/16-18 x 2	100	
ANS05080	5/16-18 x 2 1/2	50	
ANS05096	5/16-18 x 3	50	
ANS05112	5/16-18 x 3 1/2	50	
ANS05128	5/16-18 x 4	50	
ANS05144	5/16-18 x 4 1/2	50	
ANS05160	5/16-18 x 5	50	
ANS05176	5/16-18 x 5 1/2	50	
ANS05192	5/16-18 x 6	50	
ANS05208	5/16-18 x 6 1/2	50	
ANS05224	5/16-18 x 7	50	
ANS05256	5/16-18 x 8	50	
ANS06032	3/8-16 x 1	100	
ANS06040	3/8-16 x 1 1/4	100	
ANS06048	3/8-16 x 1 1/2	100	
ANS06064	3/8-16 x 2	50	
ANS06080	3/8-16 x 2 1/2	50	
ANS06096	3/8-16 x 3	50	
ANS06112	3/8-16 x 3 1/2	50	
ANS06128	3/8-16 x 4	50	
ANS06144	3/8-16 x 4 1/2	25	
ANS06160	3/8-16 x 5	25	
ANS06176	3/8-16 x 5 1/2	25	

(continued...)

## GRADE 2 CARRIAGE BOLT (cont.)

HOT-DIP GALVANIZED, UNC

Line: 157-03

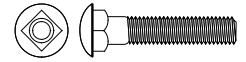

PART NUMBER	SIZE	QTY/BX	LIST PRICE
ANS06192	3/8-16 x 6	25	
ANS06208	3/8-16 x 6 1/2	25	
ANS06224	3/8-16 x 7	25	
ANS06256	3/8-16 x 8	25	
ANS06272	3/8-16 x 8 1/2	25	
ANS06288	3/8-16 x 9	25	
ANS06320	3/8-16 x 10	25	
ANS06352	3/8-16 x 11	25	
ANS06384	3/8-16 x 12	25	
ANS08032	1/2-13 x 1	50	
ANS08048	1/2-13 x 1 1/2	50	
ANS08064	1/2-13 x 2	50	
ANS08080	1/2-13 x 2 1/2	25	
ANS08096	1/2-13 x 3	25	
ANS08112	1/2-13 x 3 1/2	25	
ANS08128	1/2-13 x 4	25	
ANS08144	1/2-13 x 4 1/2	25	
ANS08160	1/2-13 x 5	25	
ANS08176	1/2-13 x 5 1/2	25	
ANS08192	1/2-13 x 6	25	
ANS08208	1/2-13 x 6 1/2	25	
ANS08224	1/2-13 x 7	25	
ANS08256	1/2-13 x 8	25	
ANS08288	1/2-13 x 9	25	
ANS08320	1/2-13 x 10	25	
ANS08352	1/2-13 x 11	25	
ANS08384	1/2-13 x 12	25	
ANS08416	1/2-13 x 13	1	
ANS08448	1/2-13 x 14	25	
ANS08480	1/2-13 x 15	1	
ANS08512	1/2-13 x 16	25	
ANS08576	1/2-13 x 18	1	
ANS08640	1/2-13 x 20	1	
ANS10048	5/8-11 x 1 1/2	25	
ANS10064	5/8-11 x 2	25	
ANS10080	5/8-11 x 2 1/2	25	
ANS10096	5/8-11 x 3	25	
ANS10112	5/8-11 x 3 1/2	25	
ANS10128	5/8-11 x 4	25	
ANS10144	5/8-11 x 4 1/2	25	
ANS10160	5/8-11 x 5	25	
ANS10176	5/8-11 x 5 1/2	25	
ANS10192	5/8-11 x 6	25	
ANS10224	5/8-11 x 7	25	

(continued...)

**GRADE 2 CARRIAGE BOLT** (cont.)

HOT-DIP GALVANIZED, UNC

Line: 157-03

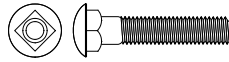

PART NUMBER	SIZE	QTY/BX	LIST PRICE
ANS10240	5/8-11 x 7 1/2	25	
ANS10256	5/8-11 x 8	25	
ANS10288	5/8-11 x 9	25	
ANS10320	5/8-11 x 10	15	
ANS10352	5/8-11 x 11	15	
ANS10384	5/8-11 x 12	15	
ANS10416	5/8-11 x 13	1	
ANS10448	5/8-11 x 14	10	
ANS10480	5/8-11 x 15	1	
ANS10512	5/8-11 x 16	1	
ANS10576	5/8-11 x 18	1	
ANS10640	5/8-11 x 20	1	
ANS12064	3/4-10 x 2	25	
ANS12080	3/4-10 x 2 1/2	25	
ANS12096	3/4-10 x 3	25	
ANS12112	3/4-10 x 3 1/2	15	
ANS12128	3/4-10 x 4	15	
ANS12144	3/4-10 x 4 1/2	15	
ANS12160	3/4-10 x 5	10	
ANS12176	3/4-10 x 5 1/2	10	
ANS12192	3/4-10 x 6	10	
ANS12224	3/4-10 x 7	10	
ANS12256	3/4-10 x 8	10	
ANS12288	3/4-10 x 9	10	
ANS12320	3/4-10 x 10	10	
ANS12352	3/4-10 x 11	10	
ANS12384	3/4-10 x 12	10	
ANS12448	3/4-10 x 14	1	
ANS12512	3/4-10 x 16	1	
ANS12576	3/4-10 x 18 (8" Thread)	1	

**TIMBER BOLT**

HOT-DIP GALVANIZED, UNC

Line: 157-04

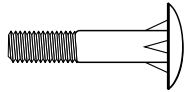

PART NUMBER	SIZE	QTY/BX	LIST PRICE
BMM08448	1/2-13 x 14	1	
BMM10640	5/8-11 x 20	1	
BMM12832	3/4 x 26	1	

**CALL - 1 (800) 723-2826****GRADE 2 SQUARE MACHINE BOLT**

PLAIN STEEL, UNC

Line: 158-00

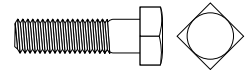

PART NUMBER	SIZE	QTY/BX	LIST PRICE
CWA04024	1/4-20 x 3/4	100	
CWA04032	1/4-20 x 1	100	
CWA04040	1/4-20 x 1 1/4	100	
CWA04048	1/4-20 x 1 1/2	100	
CWA04056	1/4-20 x 1 3/4	100	
CWA04064	1/4-20 x 2	100	
CWA04072	1/4-20 x 2 1/4	50	
CWA04080	1/4-20 x 2 1/2	50	
CWA04096	1/4-20 x 3	50	
CWA04104C	1/4-20 x 3 1/4	100	
CWA04112	1/4-20 x 3 1/2	50	
CWA04128	1/4-20 x 4	50	
CWA04144	1/4-20 x 4 1/2	50	
CWA04160	1/4-20 x 5	50	
CWA04192	1/4-20 x 6	50	
CWA04208	1/4-20 x 6 1/2	50	
CWA05024	5/16-18 x 3/4	100	
CWA05032	5/16-18 x 1	100	
CWA05040	5/16-18 x 1 1/4	100	
CWA05048	5/16-18 x 1 1/2	100	
CWA05056	5/16-18 x 1 3/4	100	
CWA05064	5/16-18 x 2	100	
CWA05080	5/16-18 x 2 1/2	50	
CWA05088	5/16-18 x 2 3/4	50	
CWA05096	5/16-18 x 3	50	
CWA05104	5/16-18 x 3 1/4	50	
CWA05112	5/16-18 x 3 1/2	50	
CWA05128	5/16-18 x 4	50	
CWA05144	5/16-18 x 4 1/2	50	
CWA05160	5/16-18 x 5	50	
CWA05176	5/16-18 x 5 1/2	50	
CWA05192	5/16-18 x 6	50	
CWA05224	5/16-18 x 7	25	
CWA06016	3/8-16 x 1/2	100	
CWA06024	3/8-16 x 3/4	100	
CWA06032	3/8-16 x 1	100	
CWA06040	3/8-16 x 1 1/4	100	
CWA06048	3/8-16 x 1 1/2	100	
CWA06056	3/8-16 x 1 3/4	50	
CWA06064	3/8-16 x 2	50	
CWA06072	3/8-16 x 2 1/4	50	
CWA06080	3/8-16 x 2 1/2	50	
CWA06088	3/8-16 x 2 3/4	50	
CWA06096	3/8-16 x 3	50	

(continued...)

**GRADE 2 SQUARE MACHINE BOLT (cont.)**

PLAIN STEEL, UNC

Line: 158-00

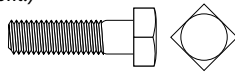

PART NUMBER	SIZE	QTY/BX	LIST PRICE
CWA06104	3/8-16 x 3 1/4	50	
CWA06112	3/8-16 x 3 1/2	50	
CWA06128	3/8-16 x 4	50	
CWA06144	3/8-16 x 4 1/2	50	
CWA06160	3/8-16 x 5	50	
CWA06176	3/8-16 x 5 1/2	50	
CWA06192	3/8-16 x 6	50	
CWA06208	3/8-16 x 6 1/2	25	
CWA06224	3/8-16 x 7	25	
CWA06240	3/8-16 x 7 1/2	25	
CWA06256	3/8-16 x 8	25	
CWA06320	3/8-16 x 10	1	
CWA08032	1/2-13 x 1	50	
CWA08040	1/2-13 x 1 1/4	50	
CWA08048	1/2-13 x 1 1/2	50	
CWA08056	1/2-13 x 1 3/4	50	
CWA08064	1/2-13 x 2	50	
CWA08072	1/2-13 x 2 1/4	25	
CWA08080	1/2-13 x 2 1/2	25	
CWA08088	1/2-13 x 2 3/4	25	
CWA08096	1/2-13 x 3	25	
CWA08112	1/2-13 x 3 1/2	25	
CWA08120	1/2-13 x 3 3/4	25	
CWA08128	1/2-13 x 4	25	
CWA08144	1/2-13 x 4 1/2	25	
CWA08160	1/2-13 x 5	25	
CWA08176	1/2-13 x 5 1/2	25	
CWA08192	1/2-13 x 6	25	
CWA08208	1/2-13 x 6 1/2	25	
CWA08224	1/2-13 x 7	25	
CWA08240	1/2-13 x 7 1/2	25	
CWA08256	1/2-13 x 8	25	
CWA08320	1/2-13 x 10	25	
CWA08384	1/2-13 x 12	25	
CWA10040	5/8-11 x 1 1/4	25	
CWA10048	5/8-11 x 1 1/2	25	
CWA10056	5/8-11 x 1 3/4	25	
CWA10064	5/8-11 x 2	25	
CWA10072	5/8-11 x 2 1/4	25	
CWA10080	5/8-11 x 2 1/2	25	
CWA10088	5/8-11 x 2 3/4	25	
CWA10096	5/8-11 x 3	25	
CWA10104	5/8-11 x 3 1/4	25	
CWA10112	5/8-11 x 3 1/2	25	

(continued...)

**GRADE 2 SQUARE MACHINE BOLT (cont.)**

PLAIN STEEL, UNC

Line: 158-00

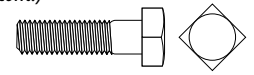

PART NUMBER	SIZE	QTY/BX	LIST PRICE
CWA10120X	5/8-11 x 3 3/4	25	
CWA10128	5/8-11 x 4	25	
CWA10144	5/8-11 x 4 1/2	25	
CWA10160	5/8-11 x 5	25	
CWA10176	5/8-11 x 5 1/2	25	
CWA10192	5/8-11 x 6	25	
CWA10208	5/8-11 x 6 1/2	25	
CWA10224	5/8-11 x 7	25	
CWA10240	5/8-11 x 7 1/2	10	
CWA10256	5/8-11 x 8	10	
CWA10272	5/8-11 x 8 1/2	10	
CWA10288	5/8-11 x 9	10	
CWA10304	5/8-11 x 9 1/2	10	
CWA10320	5/8-11 x 10	10	
CWA10384	5/8-11 x 12	10	
CWA12040	3/4-10 x 1 1/4	25	
CWA12048	3/4-10 x 1 1/2	25	
CWA12056	3/4-10 x 1 3/4	25	
CWA12064	3/4-10 x 2	25	
CWA12072	3/4-10 x 2 1/4	25	
CWA12080	3/4-10 x 2 1/2	25	
CWA12088	3/4-10 x 2 3/4	25	
CWA12096	3/4-10 x 3	25	
CWA12104	3/4-10 x 3 1/4	25	
CWA12112	3/4-10 x 3 1/2	25	
CWA12120	3/4-10 x 3 3/4	25	
CWA12128	3/4-10 x 4	25	
CWA12144	3/4-10 x 4 1/2	10	
CWA12160	3/4-10 x 5	10	
CWA12176	3/4-10 x 5 1/2	10	
CWA12192	3/4-10 x 6	10	
CWA12208	3/4-10 x 6 1/2	10	
CWA12224	3/4-10 x 7	10	
CWA12240	3/4-10 x 7 1/2	10	
CWA12256	3/4-10 x 8	10	
CWA12288	3/4-10 x 9	10	
CWA12320	3/4-10 x 10	10	
CWA12384	3/4-10 x 12	10	
CWA12480	3/4-10 x 15	1	
CWA12512	3/4-10 x 16	1	
CWA12576	3/4-10 x 18	1	
CWA14048	7/8-9 x 1 1/2	15	
CWA14056	7/8-9 x 1 3/4	15	
CWA14064	7/8-9 x 2	15	

(continued...)

**GRADE 2 SQUARE MACHINE BOLT (cont.)**

PLAIN STEEL, UNC

Line: 158-00

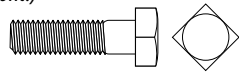

PART NUMBER	SIZE	QTY/BX	LIST PRICE
CWA14072	7/8-9 x 2 1/4	15	
CWA14080	7/8-9 x 2 1/2	15	
CWA14088	7/8-9 x 2 3/4	15	
CWA14096	7/8-9 x 3	15	
CWA14104	7/8-9 x 3 1/4	15	
CWA14112	7/8-9 x 3 1/2	15	
CWA14120X	7/8-9 x 3 3/4	15	
CWA14128	7/8-9 x 4	15	
CWA14144	7/8-9 x 4 1/2	10	
CWA14160	7/8-9 x 5	10	
CWA14176	7/8-9 x 5 1/2	10	
CWA14192	7/8-9 x 6	10	
CWA14224	7/8-9 x 7	10	
CWA14256	7/8-9 x 8	10	
CWA14288	7/8-9 x 9	1	
CWA14320	7/8-9 x 10	1	
CWA14384	7/8-9 x 12	10	
CWA16064	1-8 x 2	10	
CWA16072	1-8 x 2 1/4	10	
CWA16080	1-8 x 2 1/2	10	
CWA16096	1-8 x 3	10	
CWA16112	1-8 x 3 1/2	10	
CWA16120	1-8 x 3 3/4	10	
CWA16128	1-8 x 4	10	
CWA16144	1-8 x 4 1/2	10	
CWA16160	1-8 x 5	10	
CWA16176	1-8 x 5 1/2	10	
CWA16192	1-8 x 6	10	
CWA16208	1-8 x 6 1/2	10	
CWA16224	1-8 x 7	10	
CWA16256	1-8 x 8	5	
CWA16288	1-8 x 9	5	
CWA16320	1-8 x 10	5	
CWA16352	1-8 x 11	5	
CWA16384	1-8 x 12	5	
CWA18160X	1 1/8-7 x 5	5	
CWA18176	1 1/8-7 x 5 1/2	5	
CWA18192	1 1/8-7 x 6	5	
CWA18224	1 1/8-7 x 7	5	
CWA18256	1 1/8-7 x 8	5	
CWA18320	1 1/8-7 x 10	5	
CWA18384	1 1/8-7 x 12	5	
CWA20128	1 1/4-7 x 4	5	
CWA20144	1 1/4-7 x 4 1/2	5	

(continued...)

**GRADE 2 SQUARE MACHINE BOLT (cont.)**

PLAIN STEEL, UNC

Line: 158-00

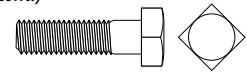

PART NUMBER	SIZE	QTY/BX	LIST PRICE
CWA20160	1 1/4-7 x 5	5	
CWA20176	1 1/4-7 x 5 1/2	1	
CWA20192	1 1/4-7 x 6	1	
CWA20224	1 1/4-7 x 7	5	
CWA20256	1 1/4-7 x 8	1	

**STEP BOLT**

ZINC PLATED, UNC - GRADE 2

Line: 160-00

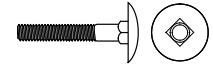

PART NUMBER	SIZE	QTY/BX	LIST PRICE
CUA04024	1/4-20 x 3/4	100	
CUA04032	1/4-20 x 1	100	
CUA04040	1/4-20 x 1 1/4	100	
CUA04048	1/4-20 x 1 1/2	100	
CUA04056	1/4-20 x 1 3/4	100	
CUA04064	1/4-20 x 2	100	
CUA04080	1/4-20 x 2 1/2	50	
CUA04096	1/4-20 x 3	50	
CUA04112X	1/4-20 x 3 1/2	50	
CUA04128X	1/4-20 x 4	50	
CUA05032	5/16-18 x 1	100	
CUA05040	5/16-18 x 1 1/4	100	
CUA05048	5/16-18 x 1 1/2	100	
CUA05056	5/16-18 x 1 3/4	50	
CUA05064	5/16-18 x 2	50	
CUA05080	5/16-18 x 2 1/2	50	
CUA05096	5/16-18 x 3	50	
CUA05160X	5/16-18 x 5	25	
CUA06032	3/8-16 x 1	100	
CUA06040	3/8-16 x 1 1/4	100	
CUA06048	3/8-16 x 1 1/2	100	
CUA06056	3/8-16 x 1 3/4	50	
CUA06064	3/8-16 x 2	50	
CUA06080	3/8-16 x 2 1/2	50	
CUA06096	3/8-16 x 3	50	



**CALL - 1 (800) 723-2826**

## GRADE 2 ELEVATOR BOLT

ZINC PLATED, UNC

Line: 162-00

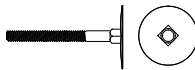

PART NUMBER	SIZE	QTY/BX	LIST PRICE
CVA04024	1/4-20 x 3/4	100	
CVA04032	1/4-20 x 1	100	
CVA04040	1/4-20 x 1 1/4	100	
CVA04048	1/4-20 x 1 1/2	100	
CVA04056	1/4-20 x 1 3/4	100	
CVA04064	1/4-20 x 2	100	
CVA04080	1/4-20 x 2 1/2	50	
CVA04096	1/4-20 x 3	50	
CVA05024	5/16-18 x 3/4	100	
CVA05032	5/16-18 x 1	100	
CVA05040	5/16-18 x 1 1/4	100	
CVA05048	5/16-18 x 1 1/2	100	
CVA05056	5/16-18 x 1 3/4	50	
CVA05064	5/16-18 x 2	50	
CVA05080	5/16-18 x 2 1/2	50	
CVA05096	5/16-18 x 3	50	
CVA06032	3/8-16 x 1	100	
CVA06040	3/8-16 x 1 1/4	100	
CVA06048	3/8-16 x 1 1/2	100	
CVA06056	3/8-16 x 1 3/4	50	
CVA06064	3/8-16 x 2	50	
CVA06080	3/8-16 x 2 1/2	50	
CVA06096	3/8-16 x 3	50	

## GRADE 8 PLOW BOLT

ZINC/YELLOW, UNC - #3 DOME HEAD

Line: 165-00

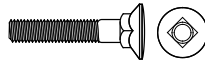

PART NUMBER	SIZE	QTY/BX	LIST PRICE
DCA10048	5/8-11 x 1 1/2	25	
DCA10056	5/8-11 x 1 3/4	25	
DCA10064	5/8-11 x 2	25	
DCA10064FLT	5/8-11 x 2 (Flat Head)	25	
DCA10072	5/8-11 x 2 1/4	25	
DCA10072FLT	5/8-11 x 2 1/4 (Flat Head)	25	
DCA10080	5/8-11 x 2 1/2	25	
DCA10080FLT	5/8-11 x 2 1/2 (Flat Head)	25	
DCA10088	5/8-11 x 2 3/4	25	
DCA10096	5/8-11 x 3	25	
DCA10096FLT	5/8-11 x 3 (Flat Head)	25	
DCA10112	5/8-11 x 3 1/2	25	
DCA10112FLT	5/8-11 x 3 1/2 (Flat Head)	25	
DCA10128	5/8-11 x 4	25	
DCA10144X	5/8-11 x 4 1/2	25	
DCA10160	5/8-11 x 5	25	
DCA10192	5/8-11 x 6	25	

(continued...)

## GRADE 8 PLOW BOLT (cont.)

ZINC/YELLOW, UNC - #3 DOME HEAD

Line: 165-00

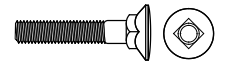

PART NUMBER	SIZE	QTY/BX	LIST PRICE
DCA12064	3/4-10 x 2	25	
DCA12072X	3/4-10 x 2 1/4	25	
DCA12080	3/4-10 x 2 1/2	25	
DCA12080FLT	3/4-10 x 2 1/2 (Flat Head)	25	
DCA12088	3/4-10 x 2 3/4	25	
DCA12088FLT	3/4-10 x 2 3/4 (Flat Head)	25	
DCA12096	3/4-10 x 3	25	
DCA12096FLT	3/4-10 x 3 (Flat Head)	25	
DCA12104X	3/4-10 x 3 1/4	25	
DCA12112	3/4-10 x 3 1/2	25	
DCA12112FLT	3/4-10 x 3 1/2 (Flat Head)	25	
DCA12128	3/4-10 x 4	25	
DCA12144	3/4-10 x 4 1/2	10	
DCA12160	3/4-10 x 5	10	
DCA12176X	3/4-10 x 5 1/2	10	
DCA12192	3/4-10 x 6	10	
DCA14080	7/8-9 x 2 1/2	15	
DCA14088	7/8-9 x 2 3/4	15	
DCA14096	7/8-9 x 3	15	
DCA14104	7/8-9 x 3 1/4	15	
DCA14112	7/8-9 x 3 1/2	15	
DCA14120X	7/8-9 x 3 3/4	10	
DCA14128	7/8-9 x 4	10	
DCA14144	7/8-9 x 4 1/2	10	
DCA14160	7/8-9 x 5	10	
DCA14192	7/8-9 x 6	10	
DCA16080X	1-8 x 2 1/2	10	
DCA16088	1-8 x 2 3/4	10	
DCA16096	1-8 x 3	10	
DCA16104	1-8 x 3 1/4	10	
DCA16112	1-8 x 3 1/2	10	
DCA16128	1-8 x 4	10	
DCA16144	1-8 x 4 1/2	10	
DCA16160	1-8 x 5	10	
DCA16176	1-8 x 5 1/2	10	
DCA16192	1-8 x 6	10	
DCA16224	1-8 x 7	10	
DCA18128	1 1/8-7 x 4	5	
DCA18160	1 1/8-7 x 5	5	
DCA18192	1 1/8-7 x 6	5	
DCA18224	1 1/8-7 x 7	5	
DCA20128	1 1/4-7 x 4 (Plain)	5	
DCA20144	1 1/4-7 x 4 1/2	5	
DCA20160	1 1/4-7 x 5	5	

(continued...)



**GRADE 8 PLOW BOLT (cont.)**

ZINC/YELLOW, UNC - #3 DOME HEAD

Line: 165-00

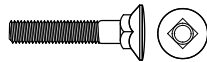

PART NUMBER	SIZE	QTY/BX	LIST PRICE
DCA20192	1 1/4-7 x 6	5	
DCA20224	1 1/4-7 x 7	5	
DCA20256	1 1/4-7 x 8	5	

**GR. 5 PLOW BOLT - FLAT HEAD**

ZINC PLATED, UNC - #3 HEAD

Line: 166-00

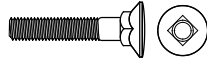

PART NUMBER	SIZE	QTY/BX	LIST PRICE
EHD06032	3/8-16 x 1	100	
EHD06040	3/8-16 x 1 1/4	100	
EHD06048	3/8-16 x 1 1/2	100	
EHD06056	3/8-16 x 1 3/4	50	
EHD06064	3/8-16 x 2	50	
EHD06080	3/8-16 x 2 1/2	50	
EHD06096	3/8-16 x 3	50	
EHD07032	7/16-14 x 1	50	
EHD07040	7/16-14 x 1 1/4	50	
EHD07040CLIP	7/16-14 x 1 1/4 (C/HD)	50	
EHD07048	7/16-14 x 1 1/2	50	
EHD07048CLIP	7/16-14 x 1 1/2 (C/HD)	50	
EHD07056	7/16-14 x 1 3/4	50	
EHD07064	7/16-14 x 2	50	
EHD07072	7/16-14 x 2 1/4	25	
EHD07080	7/16-14 x 2 1/2	25	
EHD07088	7/16-14 x 2 3/4	25	
EHD07096	7/16-14 x 3	25	
EHD08040	1/2-13 x 1 1/4	50	
EHD08048	1/2-13 x 1 1/2	50	
EHD08056	1/2-13 x 1 3/4	50	
EHD08064	1/2-13 x 2	50	
EHD08072	1/2-13 x 2 1/4	25	
EHD08080	1/2-13 x 2 1/2	25	
EHD08088	1/2-13 x 2 3/4	25	
EHD08096	1/2-13 x 3	25	
EHD08112	1/2-13 x 3 1/2	25	
EHD08128	1/2-13 x 4	25	
EHD10048	5/8-11 x 1 1/2	25	
EHD10056	5/8-11 x 1 3/4	25	
EHD10064	5/8-11 x 2	25	
EHD10072	5/8-11 x 2 1/4	25	
EHD10080	5/8-11 x 2 1/2	25	
EHD10088	5/8-11 x 2 3/4	25	
EHD10096	5/8-11 x 3	25	
EHD10112	5/8-11 x 3 1/2	25	
EHD10128	5/8-11 x 4	25	
EHD12096	3/4-10 x 3	25	

**HEX FLANGE BOLT**

PLAIN STEEL, UNC - 150M PSI (GR. 8)

Line: 167-05

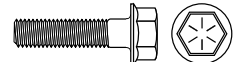

PART NUMBER	SIZE	QTY/BX	LIST PRICE
JHS06032	3/8-16 x 1	100	
JHS06040	3/8-16 x 1 1/4	100	
JHS06048	3/8-16 x 1 1/2	100	
JHS06056	3/8-16 x 1 3/4	50	
JHS06064	3/8-16 x 2	50	
JHS06080	3/8-16 x 2 1/2	50	
JHS08032	1/2-13 x 1	50	
JHS08040	1/2-13 x 1 1/4	50	
JHS08048	1/2-13 x 1 1/2	50	
JHS08056	1/2-13 x 1 3/4	50	
JHS08064	1/2-13 x 2	50	
JHS08072	1/2-13 x 2 1/4	50	
JHS08080	1/2-13 x 2 1/2	25	
JHS08088	1/2-13 x 2 3/4	25	
JHS08096	1/2-13 x 3	25	
JHS08104	1/2-13 x 3 1/4	25	
JHS08112	1/2-13 x 3 1/2	25	
JHS08128	1/2-13 x 4	25	
JHS08160	1/2-13 x 5	25	
JHS10040	5/8-11 x 1 1/4	25	
JHS10048	5/8-11 x 1 1/2	25	
JHS10056	5/8-11 x 1 3/4	25	
JHS10064	5/8-11 x 2	25	
JHS10072	5/8-11 x 2 1/4	25	
JHS10080	5/8-11 x 2 1/2	25	
JHS10088	5/8-11 x 2 3/4	25	
JHS10096	5/8-11 x 3	25	
JHS10104	5/8-11 x 3 1/4	25	
JHS10112	5/8-11 x 3 1/2	25	
JHS10128	5/8-11 x 4	25	
JHS10144	5/8-11 x 4 1/2	25	
JHS10160	5/8-11 x 5	25	
JHS12056	3/4-10 x 1 3/4	25	
JHS12064	3/4-10 x 2	25	
JHS12072	3/4-10 x 2 1/4	25	
JHS12080	3/4-10 x 2 1/2	25	
JHS12088	3/4-10 x 2 3/4	25	
JHS12096	3/4-10 x 3	25	
JHS12104	3/4-10 x 3 1/4	25	
JHS12112	3/4-10 x 3 1/2	25	
JHS12128	3/4-10 x 4	25	

## HEX FLANGE BOLT

PLAIN STEEL, UNF - 150M PSI (GRADE 8)

Line: 167-06

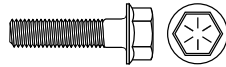

PART NUMBER	SIZE	QTY/BX	LIST PRICE
JJS08032	1/2-20 x 1	50	
JJS08040	1/2-20 x 1 1/4	50	
JJS08048	1/2-20 x 1 1/2	50	
JJS08056	1/2-20 x 1 3/4	50	
JJS08064	1/2-20 x 2	50	
JJS08080	1/2-20 x 2 1/2	25	
JJS08096	1/2-20 x 3	25	
JJS10040	5/8-18 x 1 1/4	25	
JJS10048	5/8-18 x 1 1/2	25	
JJS10056	5/8-18 x 1 3/4	25	
JJS10064	5/8-18 x 2	25	
JJS10072	5/8-18 x 2 1/4	25	
JJS10080	5/8-18 x 2 1/2	25	
JJS10088	5/8-18 x 2 3/4	25	
JJS10096	5/8-18 x 3	25	
JJS10112X	5/8-18 x 3 1/2	25	
JJS10128	5/8-18 x 4	25	
JJS10160	5/8-18 x 5	25	
JJS12056	3/4-16 x 1 3/4	25	
JJS12064	3/4-16 x 2	25	
JJS12072	3/4-16 x 2 1/4	25	
JJS12080	3/4-16 x 2 1/2	25	
JJS12096	3/4-16 x 3	25	

## GRADE 5 SERRATED HEX FLANGE BOLT

ZINC PLATED

Line: 167-10

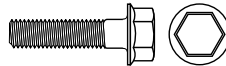

PART NUMBER	SIZE	QTY/BX	LIST PRICE
CAVS03012	#10-32 x 3/8	100	
CAVS03016	#10-32 x 1/2	100	
CAVS03020	#10-32 x 5/8	100	
CAVS03024	#10-32 x 3/4	100	
CAVS03032	#10-32 x 1	100	
CAV03012	#10-24 x 3/8	100	
CAV03016	#10-24 x 1/2	100	
CAV03020	#10-24 x 5/8	100	
CAV03024	#10-24 x 3/4	100	
CAV03032	#10-24 x 1	100	
CAV04016	1/4-20 x 1/2	100	
CAV04020	1/4-20 x 5/8	100	
CAV04024	1/4-20 x 3/4	100	
CAV04032	1/4-20 x 1	100	
CAV04040	1/4-20 x 1 1/4	100	
CAV04048	1/4-20 x 1 1/2	100	
CAV04080	1/4-20 x 2 1/2	50	

(continued...)

## GRADE 5 SERRATED HEX FLANGE BOLT (cont.)

ZINC PLATED

Line: 167-10

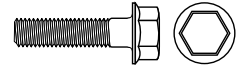

PART NUMBER	SIZE	QTY/BX	LIST PRICE
CAV05016	5/16-18 x 1/2	100	
CAV05024	5/16-18 x 3/4	100	
CAV05032	5/16-18 x 1	100	
CAV05040	5/16-18 x 1 1/4	100	
CAV05048	5/16-18 x 1 1/2	100	
CAV05056	5/16-18 x 1 3/4	100	
CAV05064	5/16-18 x 2	100	
CAV06024	3/8-16 x 3/4	100	
CAV06032	3/8-16 x 1	100	
CAV06040	3/8-16 x 1 1/4	100	
CAV06048	3/8-16 x 1 1/2	100	
CAV06056	3/8-16 x 1 3/4	50	
CAV06064	3/8-16 x 2	50	
CAV06080	3/8-16 x 2 1/2	50	
CAV08048MC	1/2-13 x 1 1/2	10	
CAV08056	1/2-13 x 1 3/4	50	

## HANGER BOLT - PLAIN CENTER

PLAIN STEEL

Line: 170-99



PART NUMBER	SIZE	QTY/BX	LIST PRICE
CHB03048	#10-24 x 1 1/2	100	
CHB03064	#10-24 x 2	100	
CHB03080	#10-24 x 2 1/2	100	
CHB03096	#10-24 x 3	100	
CHB04048	1/4-20 x 1 1/2	100	
CHB04056	1/4-20 x 1 3/4	100	
CHB04064	1/4-20 x 2	100	
CHB04080	1/4-20 x 2 1/2	100	
CHB04096	1/4-20 x 3	100	
CHB04112	1/4-20 x 3 1/2	100	
CHB04128	1/4-20 x 4	100	
CHB05048	5/16-18 x 1 1/2	100	
CHB05056	5/16-18 x 1 3/4	100	
CHB05064	5/16-18 x 2	100	
CHB05080	5/16-18 x 2 1/2	100	
CHB05096	5/16-18 x 3	100	
CHB05112	5/16-18 x 3 1/2	50	
CHB05128	5/16-18 x 4	50	
CHB05144	5/16-18 x 4 1/2	50	
CHB06064	3/8-16 x 2	100	
CHB06080	3/8-16 x 2 1/2	100	
CHB06096	3/8-16 x 3	50	
CHB06112	3/8-16 x 3 1/2	100	
CHB06128	3/8-16 x 4	50	
CHB06144	3/8-16 x 4 1/2	50	

## HANGER BOLT - CLOSED CENTER

ZINC PLATED

Line: 171-00



PART NUMBER	SIZE	QTY/BX	LIST PRICE
HXA88024	#8-32 x 3/4	100	
HXA88032	#8-32 x 1	100	
HXA88048	#8-32 x 1 1/2	100	
HXA03048	#10-24 x 1 1/2	100	
HXA03064	#10-24 x 2	100	
HXA03080MC	#10-24 x 2 1/2	100	
HXA03096	#10-24 x 3	100	
HXA04048	1/4-20 x 1 1/2	100	
HXA04056	1/4-20 x 1 3/4	100	
HXA04064	1/4-20 x 2	100	
HXA04080	1/4-20 x 2 1/2	50	
HXA04096	1/4-20 x 3	50	
HXA04112	1/4-20 x 3 1/2	50	
HXA04128	1/4-20 x 4	50	
HXA04160	1/4-20 x 5	50	

(continued...)

## HANGER BOLT - CLOSED CENTER (cont.)

ZINC PLATED

Line: 171-00



PART NUMBER	SIZE	QTY/BX	LIST PRICE
HXA04192	1/4-20 x 6	50	
HXA05048	5/16-18 x 1 1/2	50	
HXA05056	5/16-18 x 1 3/4	50	
HXA05064	5/16-18 x 2	50	
HXA05080	5/16-18 x 2 1/2	50	
HXA05096	5/16-18 x 3	50	
HXA05112MC	5/16-18 x 3 1/2	50	
HXA05128	5/16-18 x 4	50	
HXA05160	5/16-18 x 5	50	
HXA05192	5/16-18 x 6 (P/C)	50	
HXA06080	3/8-16 x 2 1/2	50	
HXA06096	3/8-16 x 3	50	
HXA06112	3/8-16 x 3 1/2	25	
HXA06128	3/8-16 x 4	25	
HXA06144X	3/8-16 x 4 1/2	25	
HXA06160	3/8-16 x 5	25	
HXA06176	3/8-16 x 5 1/2	25	
HXA06192X	3/8-16 x 6	25	

## DOWEL SCREW

PLAIN STEEL

Line: 171-01

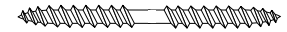

PART NUMBER	SIZE	QTY/BX	LIST PRICE
ALW03048	3/16 x 1 1/2	100	
ALW03056	3/16 x 1 3/4	100	
ALW03064	3/16 x 2	100	
ALW03080	3/16 x 2 1/2	100	
ALW03096	3/16 x 3	100	
ALW04048	1/4-20 x 1 1/2	100	
ALW04064	1/4-20 x 2	100	
ALW04080	1/4-20 x 2 1/2	50	
ALW04096	1/4-20 x 3	50	
ALW04112	1/4-20 x 3 1/2	50	
ALW05048	5/16-18 x 1 1/2	100	
ALW05064	5/16-18 x 2	50	
ALW05080	5/16-18 x 2 1/2	50	
ALW05096	5/16-18 x 3	50	
ALW05112	5/16-18 x 3 1/2	50	
ALW05128	5/16-18 x 4	50	
ALW06080	3/8-16 x 2 1/2	50	
ALW06096	3/8-16 x 3	50	
ALW06112	3/8-16 x 3 1/2	50	
ALW06128	3/8-16 x 4	50	
ALW06192Z	3/8-16 x 6 (Zinc)	50	

## ACOUSTICAL SPADE LAG SCREW

ZINC PLATED

Line: 171-02



PART NUMBER	SIZE	QTY/BX	LIST PRICE
ALY04096	1/4 x 3	50	
ALY04128	1/4 x 4	50	
ALY04160	1/4 x 5	50	

## GRADE 2 HEX HEAD LAG BOLT

ZINC PLATED

Line: 172-00



PART NUMBER	SIZE	QTY/BX	LIST PRICE
HUA04032	1/4 x 1	100	
HUA04040	1/4 x 1 1/4	100	
HUA04048	1/4 x 1 1/2	100	
HUA04056	1/4 x 1 3/4	100	
HUA04064	1/4 x 2	100	
HUA04072X	1/4 x 2 1/4	50	
HUA04080	1/4 x 2 1/2	50	
HUA04096	1/4 x 3	50	
HUA04112	1/4 x 3 1/2	50	
HUA04128	1/4 x 4	50	
HUA04144	1/4 x 4 1/2	50	
HUA04160	1/4 x 5	50	
HUA04176	1/4 x 5 1/2	50	
HUA04192	1/4 x 6	50	
HUA05032	5/16 x 1	100	
HUA05040	5/16 x 1 1/4	100	
HUA05048	5/16 x 1 1/2	100	
HUA05056	5/16 x 1 3/4	100	
HUA05064	5/16 x 2	100	
HUA05080	5/16 x 2 1/2	50	
HUA05096	5/16 x 3	50	
HUA05112	5/16 x 3 1/2	50	
HUA05128	5/16 x 4	50	
HUA05144	5/16 x 4 1/2	50	
HUA05160	5/16 x 5	50	
HUA05176	5/16 x 5 1/2	50	
HUA05192	5/16 x 6	50	
HUA06032	3/8 x 1	100	
HUA06040	3/8 x 1 1/4	100	
HUA06048	3/8 x 1 1/2	100	
HUA06056	3/8 x 1 3/4	50	
HUA06064	3/8 x 2	50	
HUA06080	3/8 x 2 1/2	50	
HUA06096	3/8 x 3	50	
HUA06112	3/8 x 3 1/2	50	
HUA06128	3/8 x 4	25	
HUA06144	3/8 x 4 1/2	25	

(continued...)

## GRADE 2 HEX HEAD LAG BOLT (cont.)

ZINC PLATED

Line: 172-00



PART NUMBER	SIZE	QTY/BX	LIST PRICE
HUA06160	3/8 x 5	25	
HUA06176	3/8 x 5 1/2	25	
HUA06192	3/8 x 6	25	
HUA06208	3/8 x 6 1/2	25	
HUA06224	3/8 x 7	25	
HUA06256	3/8 x 8	25	
HUA06320	3/8 x 10	25	
HUA08048	1/2 x 1 1/2	50	
HUA08056	1/2 x 1 3/4	50	
HUA08064	1/2 x 2	50	
HUA08080	1/2 x 2 1/2	25	
HUA08096	1/2 x 3	25	
HUA08112	1/2 x 3 1/2	25	
HUA08128	1/2 x 4	25	
HUA08144	1/2 x 4 1/2	25	
HUA08160	1/2 x 5	25	
HUA08176	1/2 x 5 1/2	25	
HUA08192	1/2 x 6	25	
HUA08208	1/2 x 6 1/2	25	
HUA08224	1/2 x 7	25	
HUA08256	1/2 x 8	25	
HUA08288	1/2 x 9	25	
HUA08320	1/2 x 10	25	
HUA08384	1/2 x 12	25	
HUA10064X	5/8 x 2	25	
HUA10080	5/8 x 2 1/2	25	
HUA10096	5/8 x 3	25	
HUA10112	5/8 x 3 1/2	25	
HUA10128	5/8 x 4	25	
HUA10144	5/8 x 4 1/2	25	
HUA10160	5/8 x 5	25	
HUA10176	5/8 x 5 1/2	25	
HUA10192	5/8 x 6	25	
HUA10224	5/8 x 7	25	
HUA10256	5/8 x 8	25	
HUA10288	5/8 x 9	10	
HUA10320	5/8 x 10	10	
HUA10384	5/8 x 12	10	
HUA12080	3/4 x 2 1/2	25	
HUA12096	3/4 x 3	25	
HUA12112	3/4 x 3 1/2	25	
HUA12128	3/4 x 4	25	
HUA12144	3/4 x 4 1/2	10	
HUA12160	3/4 x 5	10	

(continued...)

**GRADE 2 HEX HEAD LAG BOLT (cont.)**

ZINC PLATED

Line: 172-00



PART NUMBER	SIZE	QTY/BX	LIST PRICE
HUA12192	3/4 x 6	10	
HUA12224	3/4 x 7	10	
HUA12256	3/4 x 8	10	
HUA12320	3/4 x 10	10	
HUA12352	3/4 x 11	1	
HUA12384	3/4 x 12	10	

**GRADE 2 HEX HEAD LAG BOLT**

HOT-DIP GALVANIZED

Line: 173-01



PART NUMBER	SIZE	QTY/BX	LIST PRICE
ANT04032	1/4 x 1	100	
ANT04040	1/4 x 1 1/4	100	
ANT04048	1/4 x 1 1/2	100	
ANT04056	1/4 x 1 3/4	100	
ANT04064	1/4 x 2	100	
ANT04080	1/4 x 2 1/2	50	
ANT04096	1/4 x 3	50	
ANT04112	1/4 x 3 1/2	50	
ANT04128	1/4 x 4	50	
ANT04144	1/4 x 4 1/2	50	
ANT04160	1/4 x 5	50	
ANT04176	1/4 x 5 1/2	50	
ANT04192	1/4 x 6	50	
ANT05032	5/16 x 1	100	
ANT05040	5/16 x 1 1/4	100	
ANT05048	5/16 x 1 1/2	100	
ANT05064	5/16 x 2	100	
ANT05080	5/16 x 2 1/2	50	
ANT05096	5/16 x 3	50	
ANT05112	5/16 x 3 1/2	50	
ANT05128	5/16 x 4	50	
ANT05144	5/16 x 4 1/2	50	
ANT05160	5/16 x 5	50	
ANT05176	5/16 x 5 1/2	50	
ANT05192	5/16 x 6	50	
ANT06032	3/8 x 1	100	
ANT06040	3/8 x 1 1/4	100	
ANT06048	3/8 x 1 1/2	100	
ANT06064	3/8 x 2	50	
ANT06080	3/8 x 2 1/2	50	
ANT06096	3/8 x 3	50	
ANT06112	3/8 x 3 1/2	50	
ANT06128	3/8 x 4	25	
ANT06144	3/8 x 4 1/2	25	

(continued...)

**GRADE 2 HEX HEAD LAG BOLT (cont.)**

HOT-DIP GALVANIZED

Line: 173-01

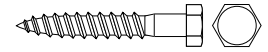

PART NUMBER	SIZE	QTY/BX	LIST PRICE
ANT06160	3/8 x 5	25	
ANT06176	3/8 x 5 1/2	25	
ANT06192	3/8 x 6	25	
ANT06224	3/8 x 7	25	
ANT06256	3/8 x 8	25	
ANT06320	3/8 x 10	25	
ANT08048	1/2 x 1 1/2	50	
ANT08064	1/2 x 2	50	
ANT08080	1/2 x 2 1/2	25	
ANT08096	1/2 x 3	25	
ANT08112	1/2 x 3 1/2	25	
ANT08128	1/2 x 4	25	
ANT08144	1/2 x 4 1/2	25	
ANT08160	1/2 x 5	25	
ANT08176	1/2 x 5 1/2	25	
ANT08192	1/2 x 6	25	
ANT08224	1/2 x 7	25	
ANT08256	1/2 x 8	25	
ANT08288	1/2 x 9	25	
ANT08320	1/2 x 10	25	
ANT08384	1/2 x 12	25	
ANT08448	1/2 x 14	1	
ANT08512	1/2 x 16	1	
ANT10064	5/8 x 2	25	
ANT10080	5/8 x 2 1/2	25	
ANT10096	5/8 x 3	25	
ANT10112	5/8 x 3 1/2	25	
ANT10128	5/8 x 4	25	
ANT10144	5/8 x 4 1/2	25	
ANT10160	5/8 x 5	25	
ANT10192	5/8 x 6	25	
ANT10224	5/8 x 7	25	
ANT10256	5/8 x 8	25	
ANT10288	5/8 x 9	15	
ANT10320	5/8 x 10	15	
ANT10384	5/8 x 12	10	
ANT12080	3/4 x 2 1/2	10	
ANT12096	3/4 x 3	10	
ANT12112	3/4 x 3 1/2	10	
ANT12128	3/4 x 4	10	
ANT12144	3/4 x 4 1/2	10	
ANT12160	3/4 x 5	10	
ANT12192	3/4 x 6	10	
ANT12224	3/4 x 7	10	

(continued...)

**GRADE 2 HEX HEAD LAG BOLT (cont.)**

HOT-DIP GALVANIZED

Line: 173-01



PART NUMBER	SIZE	QTY/BX	LIST PRICE
ANT12256	3/4 x 8	10	
ANT12288	3/4 x 9	10	
ANT12320	3/4 x 10	10	
ANT12384	3/4 x 12	10	

**GRADE 2 A307B HVY HX HD BOLT**

PLAIN STEEL, UNC

Line: 174-00

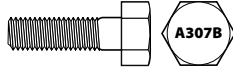

PART NUMBER	SIZE	QTY/BX	LIST PRICE
JCD08048	1/2-13 x 1 1/2	1	
JCD08064	1/2-13 x 2	1	
JCD08080	1/2-13 x 2 1/2	1	
JCD08088	1/2-13 x 2 3/4	1	
JCD08096	1/2-13 x 3	1	
JCD10056	5/8-11 x 1 3/4	1	
JCD10064	5/8-11 x 2	1	
JCD10072	5/8-11 x 2 1/4	1	
JCD10080	5/8-11 x 2 1/2	1	
JCD10088	5/8-11 x 2 3/4	1	
JCD10096	5/8-11 x 3	1	
JCD10112	5/8-11 x 3 1/2	1	
JCD10128	5/8-11 x 4	1	
JCD12048	3/4-10 x 1 1/2	1	
JCD12056	3/4-10 x 1 3/4	1	
JCD12064	3/4-10 x 2	1	
JCD12080	3/4-10 x 2 1/2	1	
JCD12088	3/4-10 x 2 3/4	1	
JCD12096	3/4-10 x 3	1	
JCD12104	3/4-10 x 3 1/4	1	
JCD12112	3/4-10 x 3 1/2	1	
JCD12128	3/4-10 x 4	1	
JCD12144	3/4-10 x 4 1/2	1	
JCD12160	3/4-10 x 5	1	
JCD12176	3/4-10 x 5 1/2	1	
JCD12192	3/4-10 x 6	1	
JCD14080	7/8-9 x 2 1/2	1	
JCD14096	7/8-9 x 3	1	
JCD14112	7/8-9 x 3 1/2	1	
JCD14120	7/8-9 x 3 3/4	1	
JCD14128	7/8-9 x 4	1	
JCD14144	7/8-9 x 4 1/2	1	
JCD14192	7/8-9 x 6	1	
JCD16080	1-8 x 2 1/2	1	
JCD16096	1-8 x 3	1	
JCD16112	1-8 x 3 1/2	1	

(continued...)

**GRADE 2 A307B HVY HX HD BOLT (cont.)**

PLAIN STEEL, UNC

Line: 174-00

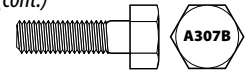

PART NUMBER	SIZE	QTY/BX	LIST PRICE
JCD16120	1-8 x 3 3/4	1	
JCD16128	1-8 x 4	1	
JCD16144	1-8 x 4 1/2	1	
JCD16160	1-8 x 5	1	
JCD16176	1-8 x 5 1/2	1	
JCD16192	1-8 x 6	1	
JCD16256	1-8 x 8	1	
JCD18096	1 1/8-7 x 3	1	
JCD18112	1 1/8-7 x 3 1/2	1	
JCD18128	1 1/8-7 x 4	1	
JCD18144	1 1/8-7 x 4 1/2	1	
JCD18160	1 1/8-7 x 5	1	
JCD18176	1 1/8-7 x 5 1/2	1	
JCD18192	1 1/8-7 x 6	1	
JCD18224	1 1/8-7 x 7	1	
JCD20096	1 1/4-7 x 3	1	
JCD20112	1 1/4-7 x 3 1/2	1	
JCD20128	1 1/4-7 x 4	1	
JCD20144	1 1/4-7 x 4 1/2	1	
JCD20160	1 1/4-7 x 5	1	
JCD20192X	1 1/4-7 x 6	1	

**CALL - 1 (800) 723-2826**

# SECTION 5 PRODUCT INDEX

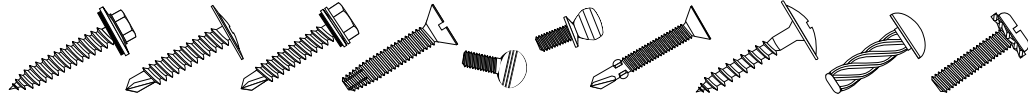

Line Description	Alpha	Line#	Page#
ROUND SLOTTED MACHINE SCREWS - ZINC	<b>DMA</b>	<b>176-00</b>	5-5
FLAT SLOTTED MACHINE SCREWS - ZINC	<b>DNA</b>	<b>177-00</b>	5-8
TRUSS SLOTTED MACHINE SCREWS - ZINC	<b>DPA</b>	<b>178-00</b>	5-12
INDENTED HEX UNSLOTTED MACHINE SCREWS - ZINC	<b>DRA</b>	<b>179-00</b>	5-13
SLOTTED/INDENTED HEX WASHER HEAD MACHINE SCREWS - ZINC PLATED	<b>CCP</b>	<b>179-01</b>	5-14
PAN SLOTTED MACHINE SCREWS - ZINC	<b>DSA</b>	<b>180-00</b>	5-15
OVAL SLOTTED MACHINE SCREWS - ZINC	<b>DTA</b>	<b>181-00</b>	5-16
WALL PLATE SLOTTED OVAL MACHINE SCREWS IN COLORS	<b>DTC</b>	<b>181-05</b>	5-17
FILLISTER SLOTTED MACHINE SCREWS - ZINC	<b>DUA</b>	<b>182-00</b>	5-17
BINDING SLOTTED MACHINE SCREWS - ZINC	<b>JVZ</b>	<b>182-01</b>	5-19
STOVE BOLTS - ROUND HEAD W/HEX NUTS - ZINC	<b>JDS</b>	<b>184-01</b>	5-20
STOVE BOLTS - FLAT HEAD W/HEX NUTS - ZINC	<b>JES</b>	<b>184-02</b>	5-21
ROUND COMBO SLOT MACHINE SCREWS - ZINC	<b>BZL</b>	<b>184-10</b>	5-22
TRUSS COMBO SLOT MACHINE SCREWS - ZINC	<b>CCX</b>	<b>184-12</b>	5-23
ROUND PHILLIPS MACHINE SCREWS - ZINC	<b>DVA</b>	<b>185-00</b>	5-23
FLAT PHILLIPS MACHINE SCREWS - ZINC	<b>DWA</b>	<b>186-00</b>	5-24
100° DEGREE PHILLIPS MACHINE SCREWS - ZINC	<b>CFD</b>	<b>186-01</b>	5-26
TRUSS PHILLIPS MACHINE SCREWS - ZINC	<b>DXA</b>	<b>187-00</b>	5-26
PAN PHILLIPS MACHINE SCREWS - ZINC	<b>DYA</b>	<b>188-00</b>	5-27
OVAL PHILLIPS MACHINE SCREWS - ZINC	<b>DZA</b>	<b>189-00</b>	5-29
FILLISTER PHILLIPS MACHINE SCREWS - ZINC	<b>EAA</b>	<b>190-00</b>	5-30
TAMPER PROOF ONE WAY MACHINE SCREWS - STAINLESS/STEEL	<b>BDZ</b>	<b>190-01</b>	5-30
TAMPER PROOF ONE WAY TAPPING SCREWS - STAINLESS/STEEL	<b>BDZ</b>	<b>190-02</b>	5-30
TAMPER PROOF SPANNER TAPPING SCREWS - STAINLESS/STEEL	<b>BED</b>	<b>190-03</b>	5-31
TAMPER PROOF SPANNER MACHINE SCREWS - STAINLESS/STEEL	<b>BED</b>	<b>190-04</b>	5-31
TAMPER PROOF PIN TORX MACHINE SCREWS - STAINLESS/STEEL	<b>BPK</b>	<b>190-05</b>	5-31
TAMPER PROOF PIN TORX TAPPING SCREWS - STAINLESS/STEEL	<b>CDF</b>	<b>190-08</b>	5-31
TORX DRIVE FLAT MACHINE SCREWS - ZINC	<b>CFG</b>	<b>190-15</b>	5-32
SLOTTED PAN EXTERNAL SEMS MACHINE SCREWS - ZINC	<b>DEU</b>	<b>190-20</b>	5-32
SLOTTED PAN INTERNAL SEMS MACHINE SCREWS - ZINC	<b>DGU</b>	<b>190-21</b>	5-32
PHILLIPS PAN EXTERNAL SEMS MACHINE SCREWS - ZINC	<b>DBU</b>	<b>190-22</b>	5-32
PHILLIPS PAN INTERNAL SEMS MACHINE SCREWS - ZINC	<b>DCU</b>	<b>190-23</b>	5-33
HEX EXTERNAL SEMS MACHINE SCREWS - ZINC	<b>DHU</b>	<b>190-24</b>	5-33
FLAT SLOTTED THREAD CUT MACHINE SCREW TYPE F - ZINC	<b>EPA</b>	<b>192-00</b>	5-33
PAN SLOTTED THREAD CUT MACHINE SCREW TYPE F - ZINC	<b>ERA</b>	<b>193-00</b>	5-33
FLOOR BOARD SCREWS SLOTTED FLAT THREAD/CUT - ZINC	<b>ESA</b>	<b>194-00</b>	5-34
HEX WASHER HD MACHINE SCREWS THREAD/CUT - ZINC	<b>ETA</b>	<b>196-00</b>	5-34
HEX SLOT WASHER HD MACHINE SCREWS THREAD/CUT - ZINC	<b>EYD</b>	<b>197-00</b>	5-35
ROUND PHILLIPS MACHINE SCREWS - THREAD/CUT(F) - ZINC	<b>EXA</b>	<b>201-00</b>	5-36
FLAT PHILLIPS MACHINE SCREWS - THREAD/CUT(F) - ZINC	<b>EYA</b>	<b>202-00</b>	5-36

(CONTINUED...)

# SECTION 5 PRODUCT INDEX

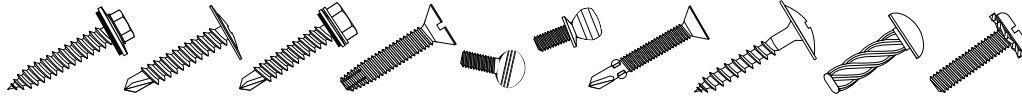

Line Description	Alpha	Line#	Page#
PAN PHILLIPS MACHINE SCREWS - THREAD/CUT(F) - ZINC	<b>EZA</b>	<b>203-00</b>	5-36
FLOOR BOARD SCREWS PHILIPS FLAT THREAD/CUT - ZINC	<b>FAA</b>	<b>204-00</b>	5-37
FLAT PHILLIPS MACHINE SCREWS - THREAD/CUT(F) - ZINC	<b>FAA</b>	<b>205-00</b>	5-37
FLOOR BOARD SCREWS TORX DRIVE THREAD/FORM - PHOS/OIL	<b>HFD</b>	<b>206-00</b>	5-37
PAN PHILLIPS TRI-LOBE THREAD ROLL SCREWS ZINC/WAX	<b>CFE</b>	<b>207-02</b>	5-37
HEX WASHER TRI-LOBE THREAD ROLL SCREWS ZINC/WAX	<b>CFF</b>	<b>207-03</b>	5-38
HEX HEAD MACHINE SCREW (TYPE F) - EXT. TOOTH LOCKWASHER - ZINC	<b>FCA</b>	<b>208-00</b>	5-38
PHILLIPS PAN MACHINE SCREW (TYPE F) - EXT. TOOTH LOCKWASHER - ZINC	<b>FGA</b>	<b>212-00</b>	5-38
PAN SLOT SHEET METAL SCREWS - A/AB - ZINC	<b>FJA</b>	<b>214-00</b>	5-38
ROUND SLOT SHEET METAL SCREWS - A/AB - ZINC	<b>FKA</b>	<b>215-00</b>	5-39
FLAT SLOT SHEET METAL SCREWS - A/AB - ZINC	<b>FLA</b>	<b>216-00</b>	5-40
TRUSS SLOT SHEET METAL SCREWS - A/AB - ZINC	<b>FMA</b>	<b>217-00</b>	5-41
HEX HD SHEET METAL SCREWS - A/AB - ZINC	<b>FNA</b>	<b>218-00</b>	5-41
UNSLOTTED HEX WASHER HEAD SHEET METAL SCREW - ZINC	<b>FNA</b>	<b>218-01</b>	5-42
HEX SLOT WASHER HD - SHEET METAL SCREWS A/AB - ZINC	<b>FNA</b>	<b>219-00</b>	5-42
HEX SLOT WASHER HD - TAPPING SCREWS - NEEDLE POINT - ZINC	<b>FNA</b>	<b>219-01</b>	5-43
OVAL SLOT SHEET METAL SCREWS - A/AB - ZINC	<b>FPA</b>	<b>220-00</b>	5-44
PAN PHILLIPS SHEET METAL SCREWS - A/AB - ZINC	<b>FRA</b>	<b>221-00</b>	5-44
PAN PHILLIPS SHEET METAL SCREWS - A/AB - BLACK/OXIDE	<b>FRA</b>	<b>221-01</b>	5-45
ROUND PHILLIPS SHEET METAL SCREWS - A/AB - ZINC	<b>FSA</b>	<b>222-00</b>	5-46
FLAT PHILLIPS SHEET METAL SCREWS - A/AB - ZINC	<b>FTA</b>	<b>223-00</b>	5-46
FLAT PHILLIPS SHEET METAL SCREWS - A/AB - BLACK/OXIDE	<b>FTA</b>	<b>223-01</b>	5-47
TRUSS PHILLIPS SHEET METAL SCREWS - A/AB - ZINC	<b>FUA</b>	<b>224-00</b>	5-48
OVAL PHILLIPS SHEET METAL SCREWS - A/AB - ZINC - BLACK/OXIDE	<b>FVA</b>	<b>225-00</b>	5-48
PAN SQUARE DRIVE TAPPING SCREWS - ZINC	<b>BBL</b>	<b>225-03</b>	5-49
PAN COMBO DRIVE TAPPING SCREWS - ZINC	<b>APD</b>	<b>226-01</b>	5-50
OVAL PHILIPS #4 TRIM HEAD TAPPING SCREWS - ZINC	<b>FWA</b>	<b>227-00</b>	5-50
OVAL PHILIPS #6 TRIM HEAD TAPPING SCREWS - ZINC	<b>FXA</b>	<b>228-00</b>	5-51
OVAL PHILIPS #10 TRIM HEAD TAPPING SCREWS - ZINC	<b>FYA</b>	<b>229-00</b>	5-51
OVAL PHILIPS #08 TRIM HEAD TAPPING SCREWS - ZINC	<b>FYA</b>	<b>230-00</b>	5-51
OVAL PHILIPS #6 TRIM HEAD TAPPING SCREWS - CHROME	<b>FAD</b>	<b>231-00</b>	5-51
OVAL PHILIPS #8 TRIM HEAD TAPPING SCREWS - CHROME	<b>FAD</b>	<b>232-00</b>	5-51
OVAL PHILIPS STD HEAD TAPPING SCREWS - CHROME	<b>FAD</b>	<b>234-00</b>	5-52
HEX SELF SEALING SHEET METAL SCREWS - ZINC	<b>GUA</b>	<b>236-00</b>	5-52
HEX SELF SEALING SHEET METAL SCREWS - 410 S/S	<b>ARW</b>	<b>236-01</b>	5-52
HEX SELF SEALING SHEET METAL SCREWS - 316 S/S	<b>AZV</b>	<b>236-02</b>	5-53
HEX SELF SEALING SHEET METAL SCREWS - 18-8 S/S	<b>BEE</b>	<b>236-03</b>	5-53
HEX SELF SEALING TEKS SCREWS - ZINC	<b>GVA</b>	<b>237-00</b>	5-53
WASHER METAL BACKED NEOPRENE SELF SEAL	<b>JZX</b>	<b>237-01</b>	5-54
HEX TEK SELF SEAL W/BONDED WASHER - 410 S/S	<b>ARX</b>	<b>237-02</b>	5-54

(CONTINUED...)



# SECTION 5 PRODUCT INDEX

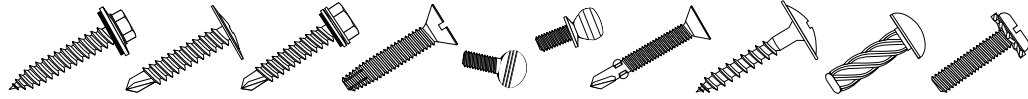

Line Description	Alpha	Line#	Page#
HEX WASHER HD #2 SELF DRILL (TEK) - ZINC (BULK PACK)	<b>GZA</b>	<b>237-95</b>	5-54
HEX WASHER HD #2 SELF DRILL (TEK) - ZINC	<b>GZA</b>	<b>238-00</b>	5-54
HEX WASHER HD #2 PT SELF DRILL (TEK) - 410 S/S	<b>ARY</b>	<b>238-01</b>	5-55
HEX WASHER HD #2 PT DRIL-KWICK P-K SCREWS - ZINC - DOMESTIC	<b>BZM</b>	<b>238-02</b>	5-55
HEX WASHER HD #3 PT SELF DRILL (TEK) - ZINC (BULK PACK)	<b>HAA</b>	<b>238-95</b>	5-55
HEX WASHER HD #3 PT SELF DRILL (TEK) - ZINC	<b>HAA</b>	<b>239-00</b>	5-56
HEX WASHER HD #3 PT SELF DRILL (TEK) - 410 S/S	<b>ARZ</b>	<b>239-01</b>	5-56
HEX WASHER HD #3 PT DRIL-KWICK P-K SCREWS - ZINC - DOMESTIC	<b>BZN</b>	<b>239-02</b>	5-56
HEX WASHER HD LONG #4/5 PT DRIL-KWICK SDS - ZINC - DOMESTIC	<b>BZP</b>	<b>239-03</b>	5-57
PHIL WAFER #3 PT DRIL-KWICK P-K SDS - ZINC - DOMESTIC	<b>BZR</b>	<b>239-10</b>	5-57
PHILLIP FLAT WOOD TO STEEL DRIL-KWICK P-K SDS - ZINC - DOMESTIC	<b>BZT</b>	<b>239-11</b>	5-57
PAN PHILLIPS #2 PT. DRIL-KWICK P-K SDS - ZINC - DOMESTIC	<b>BZV</b>	<b>239-12</b>	5-57
PAN PHILLIPS #2 PT. SDS (TEK) - 410 STAINLESS STEEL	<b>BSD</b>	<b>239-50</b>	5-57
METAL TO WOOD HEX SELF SEAL DRILL PT. IN/COLORS	<b>CDE</b>	<b>239-75</b>	5-58
PAN PHILLIPS #2 PT SDS (TEK) SCREWS - ZINC	<b>HBA</b>	<b>240-00</b>	5-58
FLAT PHILLIPS THIN WAFER HEAD SDS (TEK) - ZINC	<b>JPD</b>	<b>240-01</b>	5-59
PHILLIPS BUGEL DRYWALL SCREW FINE THREAD - BLACK	<b>AWB</b>	<b>240-02</b>	5-59
PHILLIPS BUGEL DRYWALL SCREW COARSE THREAD - BLACK	<b>ABX</b>	<b>240-03</b>	5-60
PHILLIPS BUGEL DRYWALL SCREW DRILL POINT - BLACK	<b>ABY</b>	<b>240-04</b>	5-60
PHILLIPS BUGEL DRYWALL SCREW HI-LOW THREAD - BLACK	<b>ABZ</b>	<b>240-05</b>	5-61
PHILLIPS BUGEL DECKING SCREWS WEATHER COAT	<b>ATL</b>	<b>240-06</b>	5-61
TRIM HEAD DRYWALL SCREWS PHILLIPS & SQUARE DRIVE	<b>BBR</b>	<b>240-07</b>	5-62
SQUARE DRIVE BUGLE HEAD DECKING SCREWS - STAINLESS/STEEL	<b>CAX</b>	<b>240-08</b>	5-62
PHILLIPS BUGLE HEAD DECKING SCREWS - STAINLESS/STEEL	<b>ATL</b>	<b>240-09</b>	5-62
COMBO DRIVE SUPER WOODIE TYPE 17 AUGER PT. SCREWS BLK HARD	<b>AUB</b>	<b>240-10</b>	5-62
PHILLIPS DRIVE STANDARD WOODIE A POINT HARDEND BLACK	<b>AUD</b>	<b>240-11</b>	5-62
SQUARE DRIVE STANDARD WOODIE A POINT HARDEND BLACK	<b>AUE</b>	<b>240-12</b>	5-63
SQUARE DRIVE WOODIE ALL WEATHER DECK SCREWS	<b>AUH</b>	<b>240-13</b>	5-63
PHILLIPS ROUND WASHER LATH SCREW DRILL POINT	<b>CCN</b>	<b>240-15</b>	5-63
PHILLIPS ROUND WASHER LATH SCREW NEEDLE POINT	<b>CBT</b>	<b>240-16</b>	5-63
SQUARE DRIVE BUGLE HEAD DECKING SCREWS - ALL WEATHER	<b>CCZ</b>	<b>240-23</b>	5-63
SQUARE DRIVE BUGLE HEAD DECKING SCREWS - YELLOW ZINC	<b>CCY</b>	<b>240-24</b>	5-64
PHILLIPS BUGLE HEAD DECKING SCREWS - YELLOW ZINC	<b>ATL</b>	<b>240-25</b>	5-64
FLAT SLOTTED WOOD SCREWS - ZINC PLATED	<b>HAD</b>	<b>241-00</b>	5-65
ROUND SLOTTED WOOD SCREWS - ZINC PLATED	<b>HFA</b>	<b>243-00</b>	5-67
OVAL SLOTTED WOOD SCREWS - ZINC PLATED	<b>HGA</b>	<b>244-00</b>	5-68
FLAT PHILLIPS WOOD SCREWS - ZINC PLATED	<b>HHA</b>	<b>245-00</b>	5-69
ROUND PHILLIPS WOOD SCREWS - ZINC PLATED	<b>JPG</b>	<b>245-01</b>	5-71
OVAL PHILLIPS WOOD SCREWS - ZINC PLATED	<b>JEK</b>	<b>245-02</b>	5-71
SQUARE DRIVE FLAT WOOD SCREWS - ZINC PLATED	<b>CAW</b>	<b>245-06</b>	5-72

(CONTINUED...)

# SECTION 5 PRODUCT INDEX

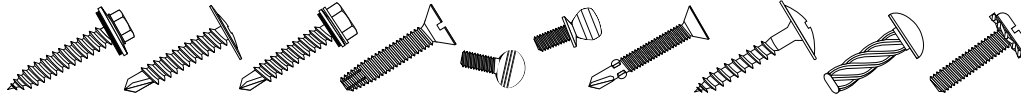

Line Description	Alpha	Line#	Page#
QUADREX DRIVE FLAT WOOD SCREWS - ZINC PLATED	<b>CET</b>	<b>245-07</b>	5-72
GARAGE DOOR SCREW PRODUCTS	<b>CCV</b>	<b>245-10</b>	5-72
SCREW COVERS FOR FLAT SQUARE OR PHILLIPS DRIVE - VAR. COLORS	<b>CCW</b>	<b>245-11</b>	5-73
PHILLIPS TRUSS DEEP THREAD PAINTED HEAD SCREWS - VAR COLORS	<b>CCW</b>	<b>245-12</b>	5-73
SQUARE DRIVE ROUND WASHER DEEP THREAD CABINET SCREWS - ZINC	<b>CCW</b>	<b>245-13</b>	5-73
PHILLIPS MODIFIED TRUSS WASHER HEAD CABINET SCREWS - ZINC	<b>CCW</b>	<b>245-14</b>	5-73
HINGE & DOOR SLIDE SCREWS - ASSORTED FINISHES	<b>CCW</b>	<b>245-15</b>	5-73
SQUARE & PHILLIPS PAN FRAMING SCREWS TYPE 17 PT - BLACK	<b>CCW</b>	<b>245-16</b>	5-74
CABINET DRAWER BOLT ASSEMBLY	<b>CCW</b>	<b>245-17</b>	5-74
PHILLIPS FLAT EURO DRAWER SLIDE CABINET SCREWS - NICKEL	<b>CCW</b>	<b>245-18</b>	5-74
THUMB SCREWS TYPE P (NO SHOULDER) ZINC	<b>KEA</b>	<b>246-00</b>	5-74
THUMB SCREWS TYPE S (WITH SHOULDER) ZINC	<b>KFA</b>	<b>247-00</b>	5-75
THUMB SCREW SOCKET HEAD - PRESS ON KNOBS	<b>CDL</b>	<b>247-01</b>	5-76
U-DRIVE ROUND HEAD DRIVE SCREWS - ZINC	<b>ZUB</b>	<b>250-00</b>	5-76



**CALL - 1 (800) 723-2826**

# SLOTTED ROUND MACHINE SCREW

ZINC PLATED

Line: 176-00

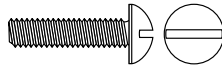

PART NUMBER	SIZE	QTY/BX	LIST PRICE
DMA00004	#0-80 x 1/8	100	
DMA00006	#0-80 x 3/16	100	
DMA00008	#0-80 x 1/4	100	
DMA00010	#0-80 x 5/16	100	
DMA00012	#0-80 x 3/8	100	
DMA00016	#0-80 x 1/2	100	
DMA00020	#0-80 x 5/8	100	
DMA00024	#0-80 x 3/4	100	
DMA11006	#1-72 x 3/16	100	
DMA11008	#1-72 x 1/4	100	
DMA11010	#1-72 x 5/16	100	
DMA11012	#1-72 x 3/8	100	
DMA11016	#1-72 x 1/2	100	
DMA11020	#1-72 x 5/8	100	
DMA11024	#1-72 x 3/4	100	
DMA22004	#2-56 x 1/8	100	
DMA22006	#2-56 x 3/16	100	
DMA22008	#2-56 x 1/4	100	
DMA22010	#2-56 x 5/16	100	
DMA22012	#2-56 x 3/8	100	
DMA22014	#2-56 x 7/16	100	
DMA22016	#2-56 x 1/2	100	
DMA22020	#2-56 x 5/8	100	
DMA22024	#2-56 x 3/4	100	
DMA22028	#2-56 x 7/8	100	
DMA22032	#2-56 x 1	100	
DMA22048	#2-56 x 1 1/2	100	
DMA522004X	#2-64 x 1/8	100	
DMA522006X	#2-64 x 3/16	100	
DMA522008X	#2-64 x 1/4	100	
DMA522012	#2-64 x 3/8	100	
DMA33004	#3-48 x 1/8	100	
DMA33006	#3-48 x 3/16	100	
DMA33008	#3-48 x 1/4	100	
DMA33010	#3-48 x 5/16	100	
DMA33012	#3-48 x 3/8	100	
DMA33014	#3-48 x 7/16	100	
DMA33016	#3-48 x 1/2	100	
DMA33020	#3-48 x 5/8	100	
DMA33024	#3-48 x 3/4	100	
DMA33028	#3-48 x 7/8	100	
DMA33032	#3-48 x 1	100	
DMA33048X	#3-48 x 1 1/2	100	
DMA533008	#3-56 x 1/4	100	

(continued...)

# SLOTTED ROUND MACHINE SCREW (cont.)

ZINC PLATED

Line: 176-00

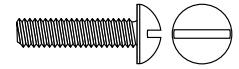

PART NUMBER	SIZE	QTY/BX	LIST PRICE
DMA533010	#3-56 x 5/16	100	
DMA533012	#3-56 x 3/8	100	
DMA533016	#3-56 x 1/2	100	
DMAU44004	#4-36 x 1/8	100	
DMAU44008	#4-36 x 1/4	100	
DMAU44010	#4-36 x 5/16	100	
DMAU44012	#4-36 x 3/8	100	
DMAU44016	#4-36 x 1/2	100	
DMAU44020	#4-36 x 5/8	100	
DMAU44024	#4-36 x 3/4	100	
DMAU44028	#4-36 x 7/8	100	
DMAU44032	#4-36 x 1	100	
DMA44004	#4-40 x 1/8	100	
DMA44006	#4-40 x 3/16	100	
DMA44008	#4-40 x 1/4	100	
DMA44010	#4-40 x 5/16	100	
DMA44012	#4-40 x 3/8	100	
DMA44014	#4-40 x 7/16	100	
DMA44016	#4-40 x 1/2	100	
DMA44018	#4-40 x 9/16	100	
DMA44020	#4-40 x 5/8	100	
DMA44024	#4-40 x 3/4	100	
DMA44028	#4-40 x 7/8	100	
DMA44032	#4-40 x 1	100	
DMA44040	#4-40 x 1 1/4	100	
DMA44048	#4-40 x 1 1/2	100	
DMA44056	#4-40 x 1 3/4	100	
DMA544004	#4-48 x 1/8	100	
DMA544006	#4-48 x 3/16	100	
DMA544008	#4-48 x 1/4	100	
DMA544010	#4-48 x 5/16	100	
DMA544012	#4-48 x 3/8	100	
DMA544016	#4-48 x 1/2	100	
DMA544024	#4-48 x 3/4	100	
DMA544032	#4-48 x 1	100	
DMA55006	#5-40 x 3/16	100	
DMA55008	#5-40 x 1/4	100	
DMA55010	#5-40 x 5/16	100	
DMA55012	#5-40 x 3/8	100	
DMA55014	#5-40 x 7/16	100	
DMA55016	#5-40 x 1/2	100	
DMA55020	#5-40 x 5/8	100	
DMA55024	#5-40 x 3/4	100	
DMA55028	#5-40 x 7/8	100	

(continued...)

# SLOTTED ROUND MACHINE SCREW (cont.)

ZINC PLATED

Line: 176-00

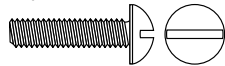

# SLOTTED ROUND MACHINE SCREW (cont.)

ZINC PLATED

Line: 176-00

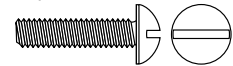

PART NUMBER	SIZE	QTY/BX	LIST PRICE
DMA55032	#5-40 x 1	100	
DMA55040	#5-40 x 1 1/4	100	
DMA55048	#5-40 x 1 1/2	100	
DMA55064	#5-40 x 2	100	
DMA55012X	#5-44 x 3/8	100	
DMA66004	#6-32 x 1/8	100	
DMA66006	#6-32 x 3/16	100	
DMA66008	#6-32 x 1/4	100	
DMA66010	#6-32 x 5/16	100	
DMA66012	#6-32 x 3/8	100	
DMA66014	#6-32 x 7/16	100	
DMA66016	#6-32 x 1/2	100	
DMA66020	#6-32 x 5/8	100	
DMA66024	#6-32 x 3/4	100	
DMA66028	#6-32 x 7/8	100	
DMA66032	#6-32 x 1	100	
DMA66036	#6-32 x 1 1/8	100	
DMA66040	#6-32 x 1 1/4	100	
DMA66048	#6-32 x 1 1/2	100	
DMA66056	#6-32 x 1 3/4	100	
DMA66064	#6-32 x 2	100	
DMA66072	#6-32 x 2 1/4	100	
DMA66080	#6-32 x 2 1/2	100	
DMA66088X	#6-32 x 2 3/4	100	
DMA66096	#6-32 x 3	100	
DMA66112	#6-32 x 3 1/2	100	
DMA66128	#6-32 x 4	100	
DMA66160	#6-32 x 5	100	
DMA66192	#6-32 x 6 (2 Thread)	100	
DMA566004X	#6-40 x 1/8	100	
DMA566008X	#6-40 x 1/4	100	
DMA566010	#6-40 x 5/16	100	
DMA566012X	#6-40 x 3/8	100	
DMA566014	#6-40 x 7/16	100	
DMA566016	#6-40 x 1/2	100	
DMA566020	#6-40 x 5/8	100	
DMA566024	#6-40 x 3/4	100	
DMA566032	#6-40 x 1	100	
DMA88004	#8-32 x 1/8	100	
DMA88006	#8-32 x 3/16	100	
DMA88008	#8-32 x 1/4	100	
DMA88010	#8-32 x 5/16	100	
DMA88012	#8-32 x 3/8	100	
DMA88014	#8-32 x 7/16	100	

(continued...)

PART NUMBER	SIZE	QTY/BX	LIST PRICE
DMA88016	#8-32 x 1/2	100	
DMA88020	#8-32 x 5/8	100	
DMA88024	#8-32 x 3/4	100	
DMA88028	#8-32 x 7/8	100	
DMA88032	#8-32 x 1	100	
DMA88036	#8-32 x 1 1/8	100	
DMA88040	#8-32 x 1 1/4	100	
DMA88048	#8-32 x 1 1/2	100	
DMA88056	#8-32 x 1 3/4	100	
DMA88064	#8-32 x 2	100	
DMA88072	#8-32 x 2 1/4	100	
DMA88080	#8-32 x 2 1/2	100	
DMA88088X	#8-32 x 2 3/4	100	
DMA88096	#8-32 x 3	100	
DMA88112	#8-32 x 3 1/2	100	
DMA88128	#8-32 x 4	100	
DMA88144	#8-32 x 4 1/2	100	
DMA88160	#8-32 x 5	100	
DMA88192	#8-32 x 6	100	
DMA588008	#8-36 x 1/4	100	
DMA588010	#8-36 x 5/16	100	
DMA588012	#8-36 x 3/8	100	
DMA588016	#8-36 x 1/2	100	
DMA588020	#8-36 x 5/8	100	
DMA588024	#8-36 x 3/4	100	
DMA588064	#8-36 x 2	100	
DMA03006	#10-24 x 3/16	100	
DMA03008	#10-24 x 1/4	100	
DMA03010	#10-24 x 5/16	100	
DMA03012	#10-24 x 3/8	100	
DMA03014	#10-24 x 7/16	100	
DMA03016	#10-24 x 1/2	100	
DMA03020	#10-24 x 5/8	100	
DMA03024	#10-24 x 3/4	100	
DMA03028	#10-24 x 7/8	100	
DMA03032	#10-24 x 1	100	
DMA03036	#10-24 x 1 1/8	100	
DMA03040	#10-24 x 1 1/4	100	
DMA03048	#10-24 x 1 1/2	100	
DMA03056	#10-24 x 1 3/4	100	
DMA03064	#10-24 x 2	100	
DMA03072	#10-24 x 2 1/4	100	
DMA03080	#10-24 x 2 1/2	100	
DMA03088	#10-24 x 2 3/4	100	

(continued...)

**SLOTTED ROUND MACHINE SCREW (cont.)**

ZINC PLATED  
Line: 176-00

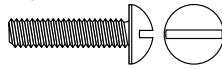

PART NUMBER	SIZE	QTY/BX	LIST PRICE
DMA03096	#10-24 x 3	100	
DMA03104	#10-24 x 3 1/4	100	
DMA03112	#10-24 x 3 1/2	100	
DMA03128	#10-24 x 4	100	
DMA03144	#10-24 x 4 1/2	100	
DMA03160	#10-24 x 5	100	
DMA03176X	#10-24 x 5 1/2	100	
DMA03192	#10-24 x 6	100	
DMAS03006	#10-32 x 3/16	100	
DMAS03008	#10-32 x 1/4	100	
DMAS03010	#10-32 x 5/16	100	
DMAS03012	#10-32 x 3/8	100	
DMAS03014	#10-32 x 7/16	100	
DMAS03016	#10-32 x 1/2	100	
DMAS03018X	#10-32 x 9/16	100	
DMAS03020	#10-32 x 5/8	100	
DMAS03024	#10-32 x 3/4	100	
DMAS03028	#10-32 x 7/8	100	
DMAS03032	#10-32 x 1	100	
DMAS03036	#10-32 x 1 1/8	100	
DMAS03040	#10-32 x 1 1/4	100	
DMAS03048	#10-32 x 1 1/2	100	
DMAS03056	#10-32 x 1 3/4	100	
DMAS03064	#10-32 x 2	100	
DMAS03072	#10-32 x 2 1/4	100	
DMAS03080	#10-32 x 2 1/2	100	
DMAS03088	#10-32 x 2 3/4	100	
DMAS03096	#10-32 x 3	100	
DMAS03104	#10-32 x 3 1/4	100	
DMAS03112	#10-32 x 3 1/2	100	
DMAS03128	#10-32 x 4	100	
DMAS03144	#10-32 x 4 1/2	100	
DMAS03160	#10-32 x 5	100	
DMAS03192	#10-32 x 6	100	
DMA21008	#12-24 x 1/4	100	
DMA21010	#12-24 x 5/16	100	
DMA21012	#12-24 x 3/8	100	
DMA21016	#12-24 x 1/2	100	
DMA21020	#12-24 x 5/8	100	
DMA21024	#12-24 x 3/4	100	
DMA21028	#12-24 x 7/8	100	
DMA21032	#12-24 x 1	100	
DMA21040	#12-24 x 1 1/4	100	
DMA21048	#12-24 x 1 1/2	100	

(continued...)

**SLOTTED ROUND MACHINE SCREW (cont.)**

ZINC PLATED  
Line: 176-00

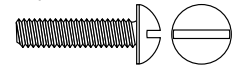

PART NUMBER	SIZE	QTY/BX	LIST PRICE
DMA21056	#12-24 x 1 3/4	100	
DMA21064	#12-24 x 2	100	
DMA21072	#12-24 x 2 1/4	100	
DMA21080	#12-24 x 2 1/2	100	
DMA21096	#12-24 x 3	100	
DMAS21012X	#12-28 x 3/8	50	
DMA04008	1/4-20 x 1/4	100	
DMA04010	1/4-20 x 5/16	100	
DMA04012	1/4-20 x 3/8	100	
DMA04014	1/4-20 x 7/16	100	
DMA04016	1/4-20 x 1/2	100	
DMA04020	1/4-20 x 5/8	100	
DMA04024	1/4-20 x 3/4	100	
DMA04028	1/4-20 x 7/8	100	
DMA04032	1/4-20 x 1	100	
DMA04036	1/4-20 x 1 1/8	100	
DMA04040	1/4-20 x 1 1/4	100	
DMA04048	1/4-20 x 1 1/2	100	
DMA04056	1/4-20 x 1 3/4	100	
DMA04064	1/4-20 x 2	100	
DMA04072	1/4-20 x 2 1/4	100	
DMA04080	1/4-20 x 2 1/2	100	
DMA04088	1/4-20 x 2 3/4	100	
DMA04096	1/4-20 x 3	100	
DMA04112	1/4-20 x 3 1/2	100	
DMA04128	1/4-20 x 4	100	
DMA04144	1/4-20 x 4 1/2	50	
DMA04160	1/4-20 x 5	50	
DMA04176	1/4-20 x 5 1/2	50	
DMA04192	1/4-20 x 6	50	
DMAS04010	1/4-28 x 5/16	100	
DMAS04012	1/4-28 x 3/8	100	
DMAS04016	1/4-28 x 1/2	100	
DMAS04020	1/4-28 x 5/8	100	
DMAS04024	1/4-28 x 3/4	100	
DMAS04028X	1/4-28 x 7/8	100	
DMAS04032	1/4-28 x 1	100	
DMAS04040	1/4-28 x 1 1/4	100	
DMAS04048	1/4-28 x 1 1/2	100	
DMAS04056	1/4-28 x 1 3/4	100	
DMAS04064	1/4-28 x 2	100	
DMAS04072X	1/4-28 x 2 1/4	50	
DMAS04080X	1/4-28 x 2 1/2	50	
DMAS04112	1/4-28 x 3 1/2	50	

(continued...)

## SLOTTED ROUND MACHINE SCREW (cont.)

ZINC PLATED

Line: 176-00

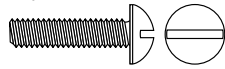

PART NUMBER	SIZE	QTY/BX	LIST PRICE
DMA054112PT	1/4-28 x 3 1/2 (2 Thread)	50	
DMA05012	5/16-18 x 3/8	100	
DMA05016	5/16-18 x 1/2	100	
DMA05020	5/16-18 x 5/8	100	
DMA05024	5/16-18 x 3/4	100	
DMA05028	5/16-18 x 7/8	100	
DMA05032	5/16-18 x 1	100	
DMA05036	5/16-18 x 1 1/8	100	
DMA05040	5/16-18 x 1 1/4	100	
DMA05048	5/16-18 x 1 1/2	100	
DMA05056	5/16-18 x 1 3/4	100	
DMA05064	5/16-18 x 2	100	
DMA05072	5/16-18 x 2 1/4	100	
DMA05080	5/16-18 x 2 1/2	100	
DMA05088	5/16-18 x 2 3/4	100	
DMA05096	5/16-18 x 3	100	
DMA05112	5/16-18 x 3 1/2	50	
DMA05128	5/16-18 x 4	50	
DMA05144	5/16-18 x 4 1/2	50	
DMA05160	5/16-18 x 5	50	
DMA05176	5/16-18 x 5 1/2	50	
DMA05192	5/16-18 x 6	50	
DMA05016	5/16-24 x 1/2	100	
DMA05032	5/16-24 x 1	100	
DMA05040X	5/16-24 x 1 1/4	100	
DMA05048	5/16-24 x 1 1/2	100	
DMA06016	3/8-16 x 1/2	50	
DMA06020	3/8-16 x 5/8	50	
DMA06024	3/8-16 x 3/4	50	
DMA06028	3/8-16 x 7/8	50	
DMA06032	3/8-16 x 1	50	
DMA06040	3/8-16 x 1 1/4	50	
DMA06048	3/8-16 x 1 1/2	50	
DMA06056	3/8-16 x 1 3/4	50	
DMA06064	3/8-16 x 2	50	
DMA06072	3/8-16 x 2 1/4	50	
DMA06080	3/8-16 x 2 1/2	50	
DMA06088	3/8-16 x 2 3/4	50	
DMA06096	3/8-16 x 3	50	
DMA06112	3/8-16 x 3 1/2	25	
DMA06128	3/8-16 x 4	25	
DMA06144	3/8-16 x 4 1/2	25	
DMA06160	3/8-16 x 5	25	
DMA06176	3/8-16 x 5 1/2	25	

(continued...)

## SLOTTED ROUND MACHINE SCREW (cont.)

ZINC PLATED

Line: 176-00

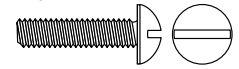

PART NUMBER	SIZE	QTY/BX	LIST PRICE
DMA06192	3/8-16 x 6	25	
DMA06032	3/8-24 x 1	100	
DMA06112X	3/8-24 x 3 1/2	25	
DMA08024	1/2-13 x 3/4	50	
DMA08032	1/2-13 x 1	50	
DMA08040	1/2-13 x 1 1/4	50	
DMA08048	1/2-13 x 1 1/2	50	
DMA08064	1/2-13 x 2	50	
DMA08072	1/2-13 x 2 1/4	50	
DMA08080	1/2-13 x 2 1/2	50	
DMA08096	1/2-13 x 3	50	
DMA08112X	1/2-13 x 3 1/2	25	
DMA08128	1/2-13 x 4	25	
DMA08160	1/2-13 x 5	25	
DMA08192	1/2-13 x 6	25	

## SLOTTED FLAT MACHINE SCREW

ZINC PLATED

Line: 177-00

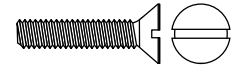

PART NUMBER	SIZE	QTY/BX	LIST PRICE
DNA00004	#0-80 x 1/8	100	
DNA00006X	#0-80 x 3/16	100	
DNA00008	#0-80 x 1/4	100	
DNA00010	#0-80 x 5/16	100	
DNA00012	#0-80 x 3/8	100	
DNA00016	#0-80 x 1/2	100	
DNA00020	#0-80 x 5/8	100	
DNA00024	#0-80 x 3/4	100	
DNA11004	#1-72 x 1/8	100	
DNA11006	#1-72 x 3/16	100	
DNA11008	#1-72 x 1/4	100	
DNA11010	#1-72 x 5/16	100	
DNA11012	#1-72 x 3/8	100	
DNA11016	#1-72 x 1/2	100	
DNA11020	#1-72 x 5/8	100	
DNA11024	#1-72 x 3/4	100	
DNA22004	#2-56 x 1/8	100	
DNA22006	#2-56 x 3/16	100	
DNA22008	#2-56 x 1/4 (Undercut)	100	
DNA22010	#2-56 x 5/16	100	
DNA22012	#2-56 x 3/8	100	
DNA22014	#2-56 x 7/16	100	
DNA22016	#2-56 x 1/2	100	
DNA22020	#2-56 x 5/8	100	
DNA22024	#2-56 x 3/4	100	

(continued...)

**SLOTTED FLAT MACHINE SCREW (cont.)**

ZINC PLATED  
Line: 177-00

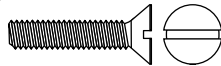

PART NUMBER	SIZE	QTY/BX	LIST PRICE
DNA22028X	#2-56 x 7/8	100	
DNA22032	#2-56 x 1	100	
DNA22040X	#2-56 x 1 1/4	100	
DNA33004	#3-48 x 1/8 (Undercut)	100	
DNA33006	#3-48 x 3/16	100	
DNA33008	#3-48 x 1/4	100	
DNA33010	#3-48 x 5/16	100	
DNA33012	#3-48 x 3/8	100	
DNA33014	#3-48 x 7/16	100	
DNA33016	#3-48 x 1/2	100	
DNA33020	#3-48 x 5/8	100	
DNA33024	#3-48 x 3/4	100	
DNA33028	#3-48 x 7/8	100	
DNA33032	#3-48 x 1	100	
DNA533008	#3-56 x 1/4	100	
DNA533010	#3-56 x 5/16	100	
DNAU44006X	#4-36 x 3/16	100	
DNAU44008	#4-36 x 1/4	100	
DNAU44010	#4-36 x 5/16	100	
DNAU44012	#4-36 x 3/8	100	
DNAU44016	#4-36 x 1/2	100	
DNAU44020	#4-36 x 5/8	100	
DNAU44024	#4-36 x 3/4	100	
DNAU44032	#4-36 x 1	100	
DNA44004	#4-40 x 1/8 (Undercut)	100	
DNA44006	#4-40 x 3/16	100	
DNA44008	#4-40 x 1/4	100	
DNA44010	#4-40 x 5/16	100	
DNA44012	#4-40 x 3/8	100	
DNA44014	#4-40 x 7/16	100	
DNA44016	#4-40 x 1/2	100	
DNA44020	#4-40 x 5/8	100	
DNA44024	#4-40 x 3/4	100	
DNA44028	#4-40 x 7/8	100	
DNA44032	#4-40 x 1	100	
DNA44040	#4-40 x 1 1/4	100	
DNA44048	#4-40 x 1 1/2	100	
DNA55008	#5-40 x 1/4	100	
DNA55010	#5-40 x 5/16	100	
DNA55012	#5-40 x 3/8	100	
DNA55014	#5-40 x 7/16	100	
DNA55016	#5-40 x 1/2	100	
DNA55018X	#5-40 x 9/16	100	
DNA55020	#5-40 x 5/8	100	

(continued...)

**SLOTTED FLAT MACHINE SCREW (cont.)**

ZINC PLATED  
Line: 177-00

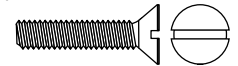

PART NUMBER	SIZE	QTY/BX	LIST PRICE
DNA55024	#5-40 x 3/4	100	
DNA55028	#5-40 x 7/8	100	
DNA55032	#5-40 x 1	100	
DNA55036X	#5-40 x 1 1/8	100	
DNA55040	#5-40 x 1 1/4	100	
DNA55048	#5-40 x 1 1/2	100	
DNA55056X	#5-40 x 1 3/4	100	
DNA55064X	#5-40 x 2	100	
DNA66006	#6-32 x 3/16 (Undercut)	100	
DNA66008	#6-32 x 1/4	100	
DNA66010	#6-32 x 5/16	100	
DNA66012	#6-32 x 3/8	100	
DNA66014	#6-32 x 7/16	100	
DNA66016	#6-32 x 1/2	100	
DNA66020	#6-32 x 5/8	100	
DNA66024	#6-32 x 3/4	100	
DNA66028	#6-32 x 7/8	100	
DNA66032	#6-32 x 1	100	
DNA66036	#6-32 x 1 1/8	100	
DNA66040	#6-32 x 1 1/4	100	
DNA66040YZ	#6-32 x 1 1/4 (Zinc/Yellow)	100	
DNA66048	#6-32 x 1 1/2	100	
DNA66056	#6-32 x 1 3/4	100	
DNA66064	#6-32 x 2	100	
DNA66072	#6-32 x 2 1/4	100	
DNA66080	#6-32 x 2 1/2	100	
DNA66088	#6-32 x 2 3/4	50	
DNA66096	#6-32 x 3	100	
DNA66128	#6-32 x 4	100	
DNA566010	#6-40 x 5/16	100	
DNA566012	#6-40 x 3/8	100	
DNA566016	#6-40 x 1/2	100	
DNA566020X	#6-40 x 5/8	100	
DNA566024	#6-40 x 3/4	100	
DNA566028	#6-40 x 7/8	100	
DNA566032	#6-40 x 1	100	
DNA566048	#6-40 x 1 1/2	100	
DNA88006	#8-32 x 3/16 (Undercut)	100	
DNA88008	#8-32 x 1/4	100	
DNA88010	#8-32 x 5/16	100	
DNA88012	#8-32 x 3/8	100	
DNA88014	#8-32 x 7/16	100	
DNA88016	#8-32 x 1/2	100	
DNA88018X	#8-32 x 9/16	100	

(continued...)

**SLOTTED FLAT MACHINE SCREW (cont.)**

ZINC PLATED

Line: 177-00

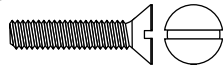

**SLOTTED FLAT MACHINE SCREW (cont.)**

ZINC PLATED

Line: 177-00

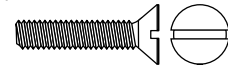

PART NUMBER	SIZE	QTY/BX	LIST PRICE
DNA88020	#8-32 x 5/8	100	
DNA88024	#8-32 x 3/4	100	
DNA88028	#8-32 x 7/8	100	
DNA88032	#8-32 x 1	100	
DNA88036	#8-32 x 1 1/8	100	
DNA88040	#8-32 x 1 1/4	100	
DNA88048	#8-32 x 1 1/2	100	
DNA88056	#8-32 x 1 3/4	100	
DNA88064	#8-32 x 2	100	
DNA88072	#8-32 x 2 1/4	100	
DNA88080	#8-32 x 2 1/2	100	
DNA88088	#8-32 x 2 3/4	100	
DNA88096	#8-32 x 3	100	
DNA88128	#8-32 x 4	100	
DNAS88010	#8-36 x 5/16	100	
DNAS88012	#8-36 x 3/8	100	
DNAS88016	#8-36 x 1/2	100	
DNAS88020	#8-36 x 5/8	100	
DNAS88024	#8-36 x 3/4	100	
DNAS88032	#8-36 x 1	100	
DNAS88064	#8-36 x 2	100	
DNA03006	#10-24 x 3/16	100	
DNA03008	#10-24 x 1/4	100	
DNA03010	#10-24 x 5/16 (Undercut)	100	
DNA03012	#10-24 x 3/8	100	
DNA03014	#10-24 x 7/16	100	
DNA03016	#10-24 x 1/2	100	
DNA03018	#10-24 x 9/16	100	
DNA03020	#10-24 x 5/8	100	
DNA03024	#10-24 x 3/4	100	
DNA03028	#10-24 x 7/8	100	
DNA03032	#10-24 x 1	100	
DNA03036	#10-24 x 1 1/8	100	
DNA03040	#10-24 x 1 1/4	100	
DNA03048	#10-24 x 1 1/2	100	
DNA03056	#10-24 x 1 3/4	100	
DNA03064	#10-24 x 2	100	
DNA03072	#10-24 x 2 1/4	100	
DNA03080	#10-24 x 2 1/2	100	
DNA03088	#10-24 x 2 3/4	100	
DNA03096	#10-24 x 3	100	
DNA03112	#10-24 x 3 1/2	100	
DNA03128	#10-24 x 4	100	
DNA03144	#10-24 x 4 1/2	100	

(continued...)

PART NUMBER	SIZE	QTY/BX	LIST PRICE
DNA03160	#10-24 x 5	100	
DNA03176	#10-24 x 5 1/2	100	
DNA03192	#10-24 x 6	100	
DNAS03008	#10-32 x 1/4 (Undercut)	100	
DNAS03010	#10-32 x 5/16	100	
DNAS03012	#10-32 x 3/8	100	
DNAS03014	#10-32 x 7/16	100	
DNAS03016	#10-32 x 1/2	100	
DNAS03020	#10-32 x 5/8	100	
DNAS03024	#10-32 x 3/4	100	
DNAS03028	#10-32 x 7/8	100	
DNAS03032	#10-32 x 1	100	
DNAS03036	#10-32 x 1 1/8	100	
DNAS03040	#10-32 x 1 1/4	100	
DNAS03048	#10-32 x 1 1/2	100	
DNAS03056	#10-32 x 1 3/4	100	
DNAS03064	#10-32 x 2	100	
DNAS03072	#10-32 x 2 1/4	100	
DNAS03080	#10-32 x 2 1/2	100	
DNAS03096	#10-32 x 3	100	
DNAS03112	#10-32 x 3 1/2	100	
DNAS03128	#10-32 x 4	100	
DNA21010	#12-24 x 5/16	100	
DNA21012	#12-24 x 3/8	100	
DNA21016	#12-24 x 1/2	100	
DNA21020	#12-24 x 5/8	100	
DNA21024	#12-24 x 3/4	100	
DNA21028	#12-24 x 7/8	100	
DNA21032	#12-24 x 1	100	
DNA21040	#12-24 x 1 1/4	100	
DNA21048	#12-24 x 1 1/2	100	
DNA21056	#12-24 x 1 3/4	100	
DNA21064	#12-24 x 2	100	
DNA21080	#12-24 x 2 1/2	100	
DNA21088	#12-24 x 2 3/4	100	
DNA21096X	#12-24 x 3	100	
DNAS21032	#12-28 x 1	50	
DNA04010	1/4-20 x 5/16	100	
DNA04012	1/4-20 x 3/8	100	
DNA04016	1/4-20 x 1/2	100	
DNA04020	1/4-20 x 5/8	100	
DNA04024	1/4-20 x 3/4	100	
DNA04028	1/4-20 x 7/8	100	
DNA04032	1/4-20 x 1	100	

(continued...)



**SLOTTED FLAT MACHINE SCREW (cont.)**

ZINC PLATED  
Line: 177-00

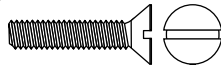

PART NUMBER	SIZE	QTY/BX	LIST PRICE
DNA04036	1/4-20 x 1 1/8	100	
DNA04040	1/4-20 x 1 1/4	100	
DNA04048	1/4-20 x 1 1/2	100	
DNA04056	1/4-20 x 1 3/4	100	
DNA04064	1/4-20 x 2	100	
DNA04072	1/4-20 x 2 1/4	100	
DNA04080	1/4-20 x 2 1/2	100	
DNA04088	1/4-20 x 2 3/4	100	
DNA04096	1/4-20 x 3	100	
DNA04112	1/4-20 x 3 1/2	100	
DNA04128	1/4-20 x 4	100	
DNA04144	1/4-20 x 4 1/2	100	
DNA04160	1/4-20 x 5	100	
DNA04176	1/4-20 x 5 1/2	100	
DNA04192	1/4-20 x 6	100	
DNAS04012	1/4-28 x 3/8	100	
DNAS04016	1/4-28 x 1/2	100	
DNAS04020	1/4-28 x 5/8	100	
DNAS04024	1/4-28 x 3/4	100	
DNAS04032	1/4-28 x 1	100	
DNAS04036X	1/4-28 x 1 1/8	100	
DNAS04040	1/4-28 x 1 1/4	100	
DNAS04048	1/4-28 x 1 1/2	50	
DNAS04064	1/4-28 x 2	50	
DNA05014	5/16-18 x 7/16	100	
DNA05016	5/16-18 x 1/2	100	
DNA05020	5/16-18 x 5/8	100	
DNA05024	5/16-18 x 3/4	100	
DNA05028	5/16-18 x 7/8	100	
DNA05032	5/16-18 x 1	100	
DNA05036	5/16-18 x 1 1/8	100	
DNA05040	5/16-18 x 1 1/4	100	
DNA05048	5/16-18 x 1 1/2	100	
DNA05056	5/16-18 x 1 3/4	100	
DNA05064	5/16-18 x 2	100	
DNA05072	5/16-18 x 2 1/4	100	
DNA05080	5/16-18 x 2 1/2	100	
DNA05088	5/16-18 x 2 3/4	100	
DNA05096	5/16-18 x 3	100	
DNA05112	5/16-18 x 3 1/2	100	
DNA05128	5/16-18 x 4	50	
DNA05144	5/16-18 x 4 1/2	50	
DNA05160	5/16-18 x 5	50	
DNA05176	5/16-18 x 5 1/2	50	

(continued...)

**SLOTTED FLAT MACHINE SCREW (cont.)**

ZINC PLATED  
Line: 177-00

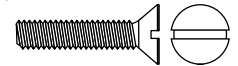

PART NUMBER	SIZE	QTY/BX	LIST PRICE
DNA05192	5/16-18 x 6	50	
DNAS05016	5/16-24 x 1/2	100	
DNAS05020	5/16-24 x 5/8	100	
DNAS05024	5/16-24 x 3/4	100	
DNAS05032	5/16-24 x 1	100	
DNAS05040	5/16-24 x 1 1/4	50	
DNAS05048	5/16-24 x 1 1/2	50	
DNAS05064	5/16-24 x 2	50	
DNA06016	3/8-16 x 1/2	50	
DNA06020	3/8-16 x 5/8	50	
DNA06024	3/8-16 x 3/4	50	
DNA06028	3/8-16 x 7/8	50	
DNA06032	3/8-16 x 1	50	
DNA06040	3/8-16 x 1 1/4	50	
DNA06048	3/8-16 x 1 1/2	50	
DNA06056	3/8-16 x 1 3/4	50	
DNA06064	3/8-16 x 2	50	
DNA06072	3/8-16 x 2 1/4	50	
DNA06080	3/8-16 x 2 1/2	50	
DNA06088	3/8-16 x 2 3/4	50	
DNA06096	3/8-16 x 3	50	
DNA06112	3/8-16 x 3 1/2	50	
DNA06128	3/8-16 x 4	50	
DNA06144	3/8-16 x 4 1/2	50	
DNA06160	3/8-16 x 5	50	
DNA06176	3/8-16 x 5 1/2	50	
DNA06192	3/8-16 x 6	50	
DNAS06016X	3/8-24 x 1/2	100	
DNA07096	7/16-14 x 3	25	
DNA08024	1/2-13 x 3/4	50	
DNA08032	1/2-13 x 1	50	
DNA08040	1/2-13 x 1 1/4	50	
DNA08048	1/2-13 x 1 1/2	50	
DNA08056	1/2-13 x 1 3/4	50	
DNA08064	1/2-13 x 2	50	
DNA08072	1/2-13 x 2 1/4	50	
DNA08080	1/2-13 x 2 1/2	50	
DNA08088	1/2-13 x 2 3/4	50	
DNA08096	1/2-13 x 3	50	
DNA08112	1/2-13 x 3 1/2	25	
DNA08128	1/2-13 x 4	25	
DNA08160	1/2-13 x 5	25	
DNA08192	1/2-13 x 6	25	

# SLOTTED TRUSS MACHINE SCREW

ZINC PLATED

Line: 178-00

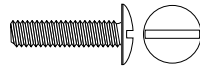

# SLOTTED TRUSS MACHINE SCREW (cont.)

ZINC PLATED

Line: 178-00

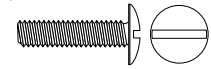

PART NUMBER	SIZE	QTY/BX	LIST PRICE
DPA44008	#4-40 x 1/4	100	
DPA44010	#4-40 x 5/16	100	
DPA44012	#4-40 x 3/8	100	
DPA44016	#4-40 x 1/2	100	
DPA44020	#4-40 x 5/8	100	
DPA44024	#4-40 x 3/4	100	
DPA44028	#4-40 x 7/8	100	
DPA44032	#4-40 x 1	100	
DPA55010	#5-40 x 5/16	100	
DPA55012	#5-40 x 3/8	100	
DPA55014	#5-40 x 7/16	100	
DPA55016	#5-40 x 1/2	100	
DPA55020	#5-40 x 5/8	100	
DPA55032	#5-40 x 1	100	
DPA66004	#6-32 x 1/8	100	
DPA66006	#6-32 x 3/16	100	
DPA66008	#6-32 x 1/4	100	
DPA66010	#6-32 x 5/16	100	
DPA66012	#6-32 x 3/8	100	
DPA66014	#6-32 x 7/16	100	
DPA66016	#6-32 x 1/2	100	
DPA66020	#6-32 x 5/8	100	
DPA66024	#6-32 x 3/4	100	
DPA66028	#6-32 x 7/8	100	
DPA66032	#6-32 x 1	100	
DPA66040	#6-32 x 1 1/4	100	
DPA66048	#6-32 x 1 1/2	100	
DPA66064	#6-32 x 2	100	
DPA66096	#6-32 x 3	50	
DPA66128	#6-32 x 4	50	
DPA88008	#8-32 x 1/4	100	
DPA88010	#8-32 x 5/16	100	
DPA88012	#8-32 x 3/8	100	
DPA88014	#8-32 x 7/16	100	
DPA88016	#8-32 x 1/2	100	
DPA88020	#8-32 x 5/8	100	
DPA88024	#8-32 x 3/4	100	
DPA88028	#8-32 x 7/8	100	
DPA88032	#8-32 x 1	100	
DPA88040	#8-32 x 1 1/4	100	
DPA88048	#8-32 x 1 1/2	100	
DPA88052	#8-32 x 1 5/8	100	
DPA88056	#8-32 x 1 3/4	100	
DPA88064	#8-32 x 2	100	

(continued...)

PART NUMBER	SIZE	QTY/BX	LIST PRICE
DPAS88010	#8-36 x 5/16	100	
DPA03008	#10-24 x 1/4	100	
DPA03010	#10-24 x 5/16	100	
DPA03012	#10-24 x 3/8	100	
DPA03014	#10-24 x 7/16	100	
DPA03016	#10-24 x 1/2	100	
DPA03020	#10-24 x 5/8	100	
DPA03024	#10-24 x 3/4	100	
DPA03028	#10-24 x 7/8	100	
DPA03032	#10-24 x 1	100	
DPA03040	#10-24 x 1 1/4	100	
DPA03048	#10-24 x 1 1/2	100	
DPA03056	#10-24 x 1 3/4	100	
DPA03064	#10-24 x 2	100	
DPA03080	#10-24 x 2 1/2	50	
DPA03096	#10-24 x 3	50	
DPA03128	#10-24 x 4	50	
DPA03160	#10-24 x 5	100	
DPA03192	#10-24 x 6	100	
DPAS03006	#10-32 x 3/16	100	
DPAS03008	#10-32 x 1/4	100	
DPAS03010	#10-32 x 5/16	100	
DPAS03012	#10-32 x 3/8	100	
DPAS03016	#10-32 x 1/2	100	
DPAS03020	#10-32 x 5/8	100	
DPAS03024	#10-32 x 3/4	100	
DPAS03032	#10-32 x 1	100	
DPAS03044	#10-32 x 1 3/8	100	
DPAS03040	#10-32 x 1 1/4	100	
DPAS03048	#10-32 x 1 1/2	100	
DPAS03064	#10-32 x 2	100	
DPA21012	#12-24 x 3/8	100	
DPA21016	#12-24 x 1/2	100	
DPA21020	#12-24 x 5/8	100	
DPA21024	#12-24 x 3/4	100	
DPA04012	1/4-20 x 3/8	100	
DPA04016	1/4-20 x 1/2	100	
DPA04020	1/4-20 x 5/8	100	
DPA04024	1/4-20 x 3/4	100	
DPA04028	1/4-20 x 7/8	100	
DPA04032	1/4-20 x 1	100	
DPA04040	1/4-20 x 1 1/4	100	
DPA04048	1/4-20 x 1 1/2	100	
DPA04056	1/4-20 x 1 3/4	100	

(continued...)

## SLOTTED TRUSS MACHINE SCREW (cont.)

ZINC PLATED

Line: 178-00

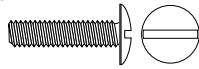

PART NUMBER	SIZE	QTY/BX	LIST PRICE
DPA04064	1/4-20 x 2	100	
DPA04072	1/4-20 x 2 1/4	50	
DPA04080	1/4-20 x 2 1/2	50	
DPA04088	1/4-20 x 2 3/4	50	
DPA04096	1/4-20 x 3	50	
DPA04112X	1/4-20 x 3 1/2	50	
DPA04128	1/4-20 x 4	50	
DPA04160	1/4-20 x 5	100	
DPA04192	1/4-20 x 6	100	
DPA05016	5/16-18 x 1/2	100	
DPA05020	5/16-18 x 5/8	100	
DPA05024	5/16-18 x 3/4	100	
DPA05032	5/16-18 x 1	100	
DPA05040	5/16-18 x 1 1/4	100	
DPA05048	5/16-18 x 1 1/2	100	
DPA05056	5/16-18 x 1 3/4	50	
DPA05064	5/16-18 x 2	50	
DPA05080	5/16-18 x 2 1/2	50	
DPA05096	5/16-18 x 3	50	
DPA06016	3/8-16 x 1/2	50	
DPA06024	3/8-16 x 3/4	50	
DPA06032	3/8-16 x 1	50	
DPA06040	3/8-16 x 1 1/4	50	
DPA06048	3/8-16 x 1 1/2	50	
DPA06064	3/8-16 x 2	50	
DPA06080	3/8-16 x 2 1/2	50	
DPA06096	3/8-16 x 3	50	
DPA06128	3/8-16 x 4	50	
DPA08024X	1/2-13 x 3/4	50	

## HEX HEAD MACHINE SCREW

UNSLOTTED/INDENTED HEAD, ZINC PLATED

Line: 179-00

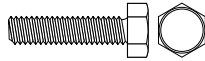

PART NUMBER	SIZE	QTY/BX	LIST PRICE
DRA44006	#4-40 x 3/16	100	
DRA44008	#4-40 x 1/4	100	
DRA44010	#4-40 x 5/16	100	
DRA44012	#4-40 x 3/8	100	
DRA44016	#4-40 x 1/2	100	
DRA44020	#4-40 x 5/8	100	
DRA44024	#4-40 x 3/4	100	
DRA44028	#4-40 x 7/8	100	
DRA44032	#4-40 x 1	100	
DRA55008	#5-40 x 1/4	100	
DRA55012	#5-40 x 3/8	100	

(continued...)

## HEX HEAD MACHINE SCREW (cont.)

UNSLOTTED/INDENTED HEAD, ZINC PLATED

Line: 179-00

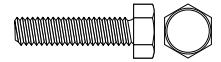

PART NUMBER	SIZE	QTY/BX	LIST PRICE
DRA55016	#5-40 x 1/2	100	
DRA55020	#5-40 x 5/8	100	
DRA55024	#5-40 x 3/4	100	
DRA55032	#5-40 x 1	100	
DRA66006	#6-32 x 3/16	100	
DRA66008	#6-32 x 1/4	100	
DRA66010	#6-32 x 5/16	100	
DRA66012	#6-32 x 3/8	100	
DRA66016	#6-32 x 1/2	100	
DRA66020	#6-32 x 5/8	100	
DRA66024	#6-32 x 3/4	100	
DRA66028	#6-32 x 7/8	100	
DRA66032	#6-32 x 1	100	
DRA66040	#6-32 x 1 1/4	100	
DRA66048	#6-32 x 1 1/2	100	
DRA66064	#6-32 x 2	100	
DRA88008	#8-32 x 1/4	100	
DRA88010	#8-32 x 5/16	100	
DRA88012	#8-32 x 3/8	100	
DRA88016	#8-32 x 1/2	100	
DRA88020	#8-32 x 5/8	100	
DRA88024	#8-32 x 3/4	100	
DRA88028	#8-32 x 7/8	100	
DRA88032	#8-32 x 1	100	
DRA88040	#8-32 x 1 1/4	100	
DRA88048	#8-32 x 1 1/2	100	
DRA88056	#8-32 x 1 3/4	50	
DRA88064	#8-32 x 2	50	
DRA03008	#10-24 x 1/4	100	
DRA03010	#10-24 x 5/16	100	
DRA03012	#10-24 x 3/8	100	
DRA03016	#10-24 x 1/2	100	
DRA03020	#10-24 x 5/8	100	
DRA03024	#10-24 x 3/4	100	
DRA03028	#10-24 x 7/8	100	
DRA03032	#10-24 x 1	100	
DRA03040	#10-24 x 1 1/4	100	
DRA03048	#10-24 x 1 1/2	100	
DRA03056	#10-24 x 1 3/4	100	
DRA03064	#10-24 x 2	100	
DRA03080	#10-24 x 2 1/2	50	
DRA03096	#10-24 x 3	50	
DRAS03008	#10-32 x 1/4	100	
DRAS03010	#10-32 x 5/16	100	

(continued...)

## HEX HEAD MACHINE SCREW (cont.)

UNSLOTTED/INDENTED HEAD, ZINC PLATED

Line: 179-00

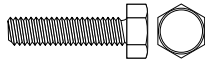

## SLOTTED/INDENTED HEX HEAD MACHINE SCREW

ZINC PLATED

Line: 179-01

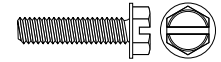

PART NUMBER	SIZE	QTY/BX	LIST PRICE
DRAS03012	#10-32 x 3/8	100	
DRAS03012GS	#10-32 x 3/8 (Green Grnd Scr.)	100	
DRAS03014	#10-32 x 7/16 (Slotted)	100	
DRAS03016	#10-32 x 1/2	100	
DRAS03020	#10-32 x 5/8	100	
DRAS03024	#10-32 x 3/4	100	
DRAS03028	#10-32 x 7/8	100	
DRAS03032	#10-32 x 1	100	
DRAS03040	#10-32 x 1 1/4	100	
DRAS03048	#10-32 x 1 1/2	100	
DRAS03056	#10-32 x 1 3/4	50	
DRAS03064	#10-32 x 2	50	
DRA21012	#12-24 x 3/8	100	
DRA21016	#12-24 x 1/2	100	
DRA21020	#12-24 x 5/8	100	
DRA21024	#12-24 x 3/4	100	
DRA21028	#12-24 x 7/8	100	
DRA21032	#12-24 x 1	100	
DRA21040	#12-24 x 1 1/4	100	
DRA21048	#12-24 x 1 1/2	50	
DRA21064	#12-24 x 2	100	
DRA04008	1/4-20 x 1/4	100	
DRA04012	1/4-20 x 3/8	100	
DRA04016	1/4-20 x 1/2	100	
DRA04020	1/4-20 x 5/8	100	
DRA04024	1/4-20 x 3/4	100	
DRA04028	1/4-20 x 7/8	100	
DRA04032	1/4-20 x 1	100	
DRA04040	1/4-20 x 1 1/4	100	
DRA04048	1/4-20 x 1 1/2	100	
DRA04056	1/4-20 x 1 3/4	100	
DRA04064	1/4-20 x 2	100	
DRA04080	1/4-20 x 2 1/2	50	
DRA04096X	1/4-20 x 3	50	
DRA05016	5/16-18 x 1/2	100	
DRA05020	5/16-18 x 5/8	100	
DRA05024	5/16-18 x 3/4	100	
DRA05032	5/16-18 x 1	100	
DRA05040	5/16-18 x 1 1/4	100	
DRA05048	5/16-18 x 1 1/2	100	
DRA05056	5/16-18 x 1 3/4	50	
DRA05064	5/16-18 x 2	50	
DRA05096	5/16-18 x 3	50	

PART NUMBER	SIZE	QTY/BX	LIST PRICE
CCP44008	#4-40 x 1/4	100	
CCP66008	#6-32 x 1/4	100	
CCP66010	#6-32 x 5/16	100	
CCP66012	#6-32 x 3/8	100	
CCP66016	#6-32 x 1/2	100	
CCP66020	#6-32 x 5/8	100	
CCP66024	#6-32 x 3/4	100	
CCP66032	#6-32 x 1	100	
CCP88008	#8-32 x 1/4	100	
CCP88010	#8-32 x 5/16	100	
CCP88012	#8-32 x 3/8	100	
CCP88016	#8-32 x 1/2	100	
CCP88020	#8-32 x 5/8	100	
CCP88024	#8-32 x 3/4	100	
CCP88032	#8-32 x 1	100	
CCP88040	#8-32 x 1 1/4	100	
CCP88048	#8-32 x 1 1/2	100	
CCP03008	#10-24 x 1/4	100	
CCP03012	#10-24 x 3/8	100	
CCP03016	#10-24 x 1/2	100	
CCP03020	#10-24 x 5/8	100	
CCP03024	#10-24 x 3/4	100	
CCP03032	#10-24 x 1	100	
CCP03040	#10-24 x 1 1/4	100	
CCP03048	#10-24 x 1 1/2	100	
CCP03064	#10-24 x 2	100	
CCPS03008	#10-32 x 1/4	100	
CCPS03012	#10-32 x 3/8	100	
CCPS03016	#10-32 x 1/2	100	
CCPS03020	#10-32 x 5/8	100	
CCPS03024	#10-32 x 3/4	100	
CCPS03032	#10-32 x 1	100	
CCPS03040	#10-32 x 1 1/4	100	
CCPS03048	#10-32 x 1 1/2	100	
CCP04010	1/4-20 x 5/16	100	
CCP04012	1/4-20 x 3/8	100	
CCP04016	1/4-20 x 1/2	100	
CCP04020	1/4-20 x 5/8	100	
CCP04024	1/4-20 x 3/4	100	
CCP04032	1/4-20 x 1	100	
CCP04040	1/4-20 x 1 1/4	100	
CCP04048	1/4-20 x 1 1/2	100	
CCP04064	1/4-20 x 2	100	

# SLOTTED PAN MACHINE SCREW

ZINC PLATED

Line: 180-00

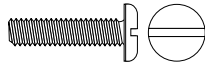

PART NUMBER	SIZE	QTY/BX	LIST PRICE
DSA22004	#2-56 x 1/8	100	
DSA22006	#2-56 x 3/16	100	
DSA22008	#2-56 x 1/4	100	
DSA22010	#2-56 x 5/16	100	
DSA22012	#2-56 x 3/8	100	
DSA22014	#2-56 x 7/16	100	
DSA22016	#2-56 x 1/2	100	
DSA22020	#2-56 x 5/8	100	
DSA22024	#2-56 x 3/4	100	
DSA22032	#2-56 x 1	100	
DSA33006	#3-48 x 3/16	100	
DSA33008	#3-48 x 1/4	100	
DSA33010	#3-48 x 5/16	100	
DSA33012	#3-48 x 3/8	100	
DSA33016	#3-48 x 1/2	100	
DSA33020	#3-48 x 5/8	100	
DSA33024	#3-48 x 3/4	100	
DSA33028	#3-48 x 7/8	100	
DSA33032	#3-48 x 1	100	
DSA44004	#4-40 x 1/8	100	
DSA44006	#4-40 x 3/16	100	
DSA44008	#4-40 x 1/4	100	
DSA44010	#4-40 x 5/16	100	
DSA44012	#4-40 x 3/8	100	
DSA44014X	#4-40 x 7/16	100	
DSA44016	#4-40 x 1/2	100	
DSA44018	#4-40 x 9/16	100	
DSA44020	#4-40 x 5/8	100	
DSA44024	#4-40 x 3/4	100	
DSA44028	#4-40 x 7/8	100	
DSA44032	#4-40 x 1	100	
DSA44040	#4-40 x 1 1/4	100	
DSA44048	#4-40 x 1 1/2	100	
DSA55006	#5-40 x 3/16	100	
DSA55008	#5-40 x 1/4	100	
DSA55010	#5-40 x 5/16	100	
DSA55012	#5-40 x 3/8	100	
DSA55016	#5-40 x 1/2	100	
DSA55020	#5-40 x 5/8	100	
DSA55024	#5-40 x 3/4	100	
DSA55032	#5-40 x 1	100	
DSA55040	#5-40 x 1 1/4	100	
DSA55048	#5-40 x 1 1/2	100	
DSA66004	#6-32 x 1/8	100	

(continued...)

# SLOTTED PAN MACHINE SCREW (cont.)

ZINC PLATED

Line: 180-00

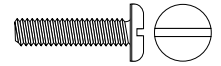

PART NUMBER	SIZE	QTY/BX	LIST PRICE
DSA66006	#6-32 x 3/16	100	
DSA66008	#6-32 x 1/4	100	
DSA66010	#6-32 x 5/16	100	
DSA66012	#6-32 x 3/8	100	
DSA66014	#6-32 x 7/16	100	
DSA66016	#6-32 x 1/2	100	
DSA66020	#6-32 x 5/8	100	
DSA66024	#6-32 x 3/4	100	
DSA66028	#6-32 x 7/8	100	
DSA66032	#6-32 x 1	100	
DSA66040	#6-32 x 1 1/4	100	
DSA66048	#6-32 x 1 1/2	100	
DSA66056	#6-32 x 1 3/4	100	
DSA66064	#6-32 x 2	100	
DSA66072X	#6-32 x 2 1/4	50	
DSA66080	#6-32 x 2 1/2	100	
DSA66096	#6-32 x 3	100	
DSA88006	#8-32 x 3/16	100	
DSA88008	#8-32 x 1/4	100	
DSA88010	#8-32 x 5/16	100	
DSA88012	#8-32 x 3/8	100	
DSA88014	#8-32 x 7/16	100	
DSA88016	#8-32 x 1/2	100	
DSA88020	#8-32 x 5/8	100	
DSA88024	#8-32 x 3/4	100	
DSA88028	#8-32 x 7/8	100	
DSA88032	#8-32 x 1	100	
DSA88040	#8-32 x 1 1/4	100	
DSA88048	#8-32 x 1 1/2	100	
DSA88056	#8-32 x 1 3/4	100	
DSA88064	#8-32 x 2	100	
DSA88072	#8-32 x 2 1/4	100	
DSA88080	#8-32 x 2 1/2	100	
DSA88096	#8-32 x 3	100	
DSA03006	#10-24 x 3/16	100	
DSA03008	#10-24 x 1/4	100	
DSA03010	#10-24 x 5/16	100	
DSA03012	#10-24 x 3/8	100	
DSA03014	#10-24 x 7/16	100	
DSA03016	#10-24 x 1/2	100	
DSA03018X	#10-24 x 9/16	100	
DSA03020	#10-24 x 5/8	100	
DSA03024	#10-24 x 3/4	100	
DSA03028	#10-24 x 7/8	100	

(continued...)

## SLOTTED PAN MACHINE SCREW (cont.)

ZINC PLATED

Line: 180-00

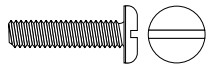

PART NUMBER	SIZE	QTY/BX	LIST PRICE
DSA03032	#10-24 x 1	100	
DSA03036	#10-24 x 1 1/8	100	
DSA03040	#10-24 x 1 1/4	100	
DSA03048	#10-24 x 1 1/2	100	
DSA03056	#10-24 x 1 3/4	100	
DSA03064	#10-24 x 2	100	
DSA03080	#10-24 x 2 1/2	100	
DSA03096X	#10-24 x 3	100	
DSAS03006	#10-32 x 3/16	100	
DSAS03008	#10-32 x 1/4	100	
DSAS03010	#10-32 x 5/16	100	
DSAS03012	#10-32 x 3/8	100	
DSAS03014	#10-32 x 7/16	100	
DSAS03016	#10-32 x 1/2	100	
DSAS03020	#10-32 x 5/8	100	
DSAS03024	#10-32 x 3/4	100	
DSAS03028	#10-32 x 7/8	100	
DSAS03032	#10-32 x 1	100	
DSAS03040	#10-32 x 1 1/4	100	
DSAS03048	#10-32 x 1 1/2	100	
DSAS03056	#10-32 x 1 3/4	100	
DSAS03064	#10-32 x 2	100	
DSAS03080	#10-32 x 2 1/2	100	
DSAS03096	#10-32 x 3	100	
DSA21008	#12-24 x 1/4	100	
DSA21010	#12-24 x 5/16	100	
DSA21012	#12-24 x 3/8	100	
DSA21016	#12-24 x 1/2	100	
DSA21020X	#12-24 x 5/8	100	
DSA21024	#12-24 x 3/4	100	
DSA21032	#12-24 x 1	100	
DSA21040	#12-24 x 1 1/4	100	
DSA21048	#12-24 x 1 1/2	100	
DSA21064	#12-24 x 2	50	
DSA04008	1/4-20 x 1/4	100	
DSA04010	1/4-20 x 5/16	100	
DSA04012	1/4-20 x 3/8	100	
DSA04014X	1/4-20 x 7/16	100	
DSA04016	1/4-20 x 1/2	100	
DSA04020	1/4-20 x 5/8	100	
DSA04024	1/4-20 x 3/4	100	
DSA04028	1/4-20 x 7/8	100	
DSA04032	1/4-20 x 1	100	
DSA04040	1/4-20 x 1 1/4	100	

(continued...)

## SLOTTED PAN MACHINE SCREW (cont.)

ZINC PLATED

Line: 180-00

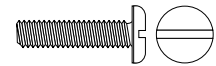

PART NUMBER	SIZE	QTY/BX	LIST PRICE
DSA04048	1/4-20 x 1 1/2	100	
DSA04056	1/4-20 x 1 3/4	100	
DSA04064	1/4-20 x 2	100	
DSA04072	1/4-20 x 2 1/4	100	
DSA04080	1/4-20 x 2 1/2	100	
DSA04096	1/4-20 x 3	100	
DSA04128	1/4-20 x 4	100	
DSAS04012	1/4-28 x 3/8	100	
DSAS04016	1/4-28 x 1/2	100	
DSAS04020	1/4-28 x 5/8	100	
DSAS04024	1/4-28 x 3/4	100	
DSAS04032	1/4-28 x 1	100	
DSAS04040	1/4-28 x 1 1/4	100	
DSAS04048	1/4-28 x 1 1/2	100	
DSA05016	5/16-18 x 1/2	100	
DSA05020	5/16-18 x 5/8	100	
DSA05024	5/16-18 x 3/4	100	
DSA05032	5/16-18 x 1	100	
DSA05040	5/16-18 x 1 1/4	100	
DSA05048	5/16-18 x 1 1/2	100	
DSA05064	5/16-18 x 2	100	

## SLOTTED OVAL MACHINE SCREW

ZINC PLATED

Line: 181-00

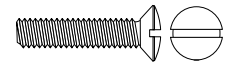

PART NUMBER	SIZE	QTY/BX	LIST PRICE
DTA44008	#4-40 x 1/4	100	
DTA44010	#4-40 x 5/16	100	
DTA44012	#4-40 x 3/8	100	
DTA44016	#4-40 x 1/2	100	
DTA44020	#4-40 x 5/8	100	
DTA44032	#4-40 x 1	100	
DTA44048	#4-40 x 1 1/2	100	
DTA55012	#5-40 x 3/8	100	
DTA55016	#5-40 x 1/2	100	
DTA66006	#6-32 x 3/16	100	
DTA66008	#6-32 x 1/4	100	
DTA66010	#6-32 x 5/16	100	
DTA66012	#6-32 x 3/8	100	
DTA66014	#6-32 x 7/16	100	
DTA66016	#6-32 x 1/2	100	
DTA66020	#6-32 x 5/8	100	
DTA66024	#6-32 x 3/4	100	
DTA66032	#6-32 x 1	100	
DTA66040	#6-32 x 1 1/4	100	

(continued...)

**SLOTTED OVAL MACHINE SCREW (cont.)**

ZINC PLATED  
Line: 181-00

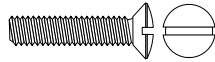

PART NUMBER	SIZE	QTY/BX	LIST PRICE
DTA66048	#6-32 x 1 1/2	100	
DTA66064	#6-32 x 2	100	
DTA88008	#8-32 x 1/4	100	
DTA88012	#8-32 x 3/8	100	
DTA88016	#8-32 x 1/2	100	
DTA88020	#8-32 x 5/8	100	
DTA88024	#8-32 x 3/4	100	
DTA88028	#8-32 x 7/8	100	
DTA88032	#8-32 x 1	100	
DTA88040	#8-32 x 1 1/4	100	
DTA88048	#8-32 x 1 1/2	100	
DTA88056	#8-32 x 1 3/4	100	
DTA88064	#8-32 x 2	100	
DTA03008	#10-24 x 1/4	100	
DTA03012	#10-24 x 3/8	100	
DTA03014	#10-24 x 7/16	100	
DTA03016	#10-24 x 1/2	100	
DTA03020	#10-24 x 5/8	100	
DTA03024	#10-24 x 3/4	100	
DTA03032	#10-24 x 1	100	
DTA03040	#10-24 x 1 1/4	100	
DTA03048	#10-24 x 1 1/2	100	
DTA03056	#10-24 x 1 3/4	100	
DTA03064	#10-24 x 2	100	
DTA03096	#10-24 x 3	100	
DTAS03010	#10-32 x 5/16	100	
DTAS03012	#10-32 x 3/8	100	
DTAS03016	#10-32 x 1/2	100	
DTAS03020	#10-32 x 5/8	100	
DTAS03024	#10-32 x 3/4	100	
DTAS03032	#10-32 x 1	100	
DTAS03040	#10-32 x 1 1/4	100	
DTAS03048	#10-32 x 1 1/2	100	
DTAS03064	#10-32 x 2	100	
DTA21012	#12-24 x 3/8	100	
DTA21016	#12-24 x 1/2	100	
DTA21024	#12-24 x 3/4	100	
DTA21032	#12-24 x 1	100	
DTA21040	#12-24 x 1 1/4	100	
DTA04012	1/4-20 x 3/8	100	
DTA04016	1/4-20 x 1/2	100	
DTA04020	1/4-20 x 5/8	100	
DTA04024	1/4-20 x 3/4	100	
DTA04032	1/4-20 x 1	100	

(continued...)

**SLOTTED OVAL MACHINE SCREW (cont.)**

ZINC PLATED  
Line: 181-00

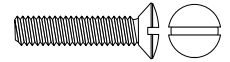

PART NUMBER	SIZE	QTY/BX	LIST PRICE
DTA04040	1/4-20 x 1 1/4	100	
DTA04048	1/4-20 x 1 1/2	100	
DTA04056	1/4-20 x 1 3/4	100	
DTA04064	1/4-20 x 2	100	
DTA04080	1/4-20 x 2 1/2	50	
DTA05024	5/16-18 x 3/4	100	
DTA05032	5/16-18 x 1	100	
DTA05040	5/16-18 x 1 1/4	100	
DTA05048	5/16-18 x 1 1/2	100	

**WALL PLATE SCREW**

ZINC PLATED, ASSORTED COLOR HEADS  
Line: 181-05

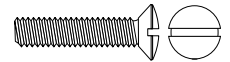

PART NUMBER	SIZE	QTY/BX	LIST PRICE
DTC66008WT	#6-32 x 1/4 (White)	100	
DTC66016BR	#6-32 x 1/2 (Brass)	100	
DTC66016BN	#6-32 x 1/2 (Brown)	100	
DTC66016IV	#6-32 x 1/2 (Ivory)	100	
DTC66016NK	#6-32 x 1/2 (Nickel)	100	
DTC66016WT	#6-32 x 1/2 (White)	100	

**SLOTTED FILLISTER MACHINE SCREW**

ZINC PLATED  
Line: 182-00

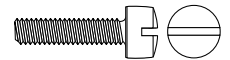

PART NUMBER	SIZE	QTY/BX	LIST PRICE
DUA22004	#2-56 x 1/8	100	
DUA22006	#2-56 x 3/16	100	
DUA22008	#2-56 x 1/4	100	
DUA22010	#2-56 x 5/16	100	
DUA22012	#2-56 x 3/8	100	
DUA22014	#2-56 x 7/16	100	
DUA22016	#2-56 x 1/2	100	
DUA22020	#2-56 x 5/8	100	
DUA22024	#2-56 x 3/4	100	
DUA522008	#2-64 x 1/4	100	
DUA33004	#3-48 x 1/8	100	
DUA33006	#3-48 x 3/16	100	
DUA33008	#3-48 x 1/4	100	
DUA33010	#3-48 x 5/16	100	
DUA33012	#3-48 x 3/8	100	
DUA33016	#3-48 x 1/2	100	
DUA33020	#3-48 x 5/8	100	
DUA33024	#3-48 x 3/4	100	
DUA33032	#3-48 x 1	100	
DUA533008	#3-56 x 1/4	100	
DUA44006	#4-40 x 3/16	100	

(continued...)

**SLOTTED FILLISTER MACHINE SCREW (cont.)**

ZINC PLATED

Line: 182-00

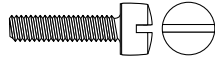

**SLOTTED FILLISTER MACHINE SCREW (cont.)**

ZINC PLATED

Line: 182-00

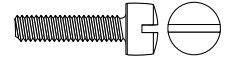

SCREWS - SECTION 05 PAGE 5-18

PART NUMBER	SIZE	QTY/BX	LIST PRICE
DUA44008	#4-40 x 1/4	100	
DUA44010	#4-40 x 5/16	100	
DUA44012	#4-40 x 3/8	100	
DUA44016	#4-40 x 1/2	100	
DUA44020	#4-40 x 5/8	100	
DUA44024	#4-40 x 3/4	100	
DUA44028	#4-40 x 7/8	100	
DUA44032	#4-40 x 1	100	
DUA44040	#4-40 x 1 1/4	100	
DUA44048	#4-40 x 1 1/2	100	
DUA5544006	#4-48 x 3/16	100	
DUA5544010	#4-48 x 5/16	100	
DUA5544012	#4-48 x 3/8	100	
DUA5544016	#4-48 x 1/2	100	
DUA5544032	#4-48 x 1	100	
DUA55004	#5-40 x 1/8	100	
DUA55006	#5-40 x 3/16	100	
DUA55008	#5-40 x 1/4	100	
DUA55010	#5-40 x 5/16	100	
DUA55012	#5-40 x 3/8	100	
DUA55014	#5-40 x 7/16	100	
DUA55016	#5-40 x 1/2	100	
DUA55020	#5-40 x 5/8	100	
DUA55024	#5-40 x 3/4	100	
DUA55028	#5-40 x 7/8	100	
DUA55032	#5-40 x 1	100	
DUA55040	#5-40 x 1 1/4	100	
DUA66006	#6-32 x 3/16	100	
DUA66008	#6-32 x 1/4	100	
DUA66010	#6-32 x 5/16	100	
DUA66012	#6-32 x 3/8	100	
DUA66014	#6-32 x 7/16	100	
DUA66016	#6-32 x 1/2	100	
DUA66020	#6-32 x 5/8	100	
DUA66024	#6-32 x 3/4	100	
DUA66028	#6-32 x 7/8	100	
DUA66032	#6-32 x 1	100	
DUA66040	#6-32 x 1 1/4	100	
DUA66048	#6-32 x 1 1/2	100	
DUA66064	#6-32 x 2	100	
DUA88006	#8-32 x 3/16	100	
DUA88008	#8-32 x 1/4	100	
DUA88010	#8-32 x 5/16	100	
DUA88012	#8-32 x 3/8	100	

(continued...)

PART NUMBER	SIZE	QTY/BX	LIST PRICE
DUA88014	#8-32 x 7/16	100	
DUA88016	#8-32 x 1/2	100	
DUA88020	#8-32 x 5/8	100	
DUA88024	#8-32 x 3/4	100	
DUA88028	#8-32 x 7/8	100	
DUA88032	#8-32 x 1	100	
DUA88040	#8-32 x 1 1/4	100	
DUA88048	#8-32 x 1 1/2	100	
DUA88056	#8-32 x 1 3/4	100	
DUA88064	#8-32 x 2	100	
DUA88072	#8-32 x 2 1/4	50	
DUA88080	#8-32 x 2 1/2	50	
DUA88012	#8-36 x 3/8	100	
DUA88016X	#8-36 x 1/2	100	
DUA88024	#8-36 x 3/4	100	
DUA88028X	#8-36 x 7/8	100	
DUA03008	#10-24 x 1/4	100	
DUA03010	#10-24 x 5/16	100	
DUA03012	#10-24 x 3/8	100	
DUA03016	#10-24 x 1/2	100	
DUA03020	#10-24 x 5/8	100	
DUA03024	#10-24 x 3/4	100	
DUA03028	#10-24 x 7/8	100	
DUA03032	#10-24 x 1	100	
DUA03036	#10-24 x 1 1/8	100	
DUA03040	#10-24 x 1 1/4	100	
DUA03048	#10-24 x 1 1/2	100	
DUA03056	#10-24 x 1 3/4	100	
DUA03064	#10-24 x 2	100	
DUA03072	#10-24 x 2 1/4	100	
DUA03080	#10-24 x 2 1/2	100	
DUA03088	#10-24 x 2 3/4	100	
DUA03096	#10-24 x 3	100	
DUA03008	#10-32 x 1/4	100	
DUA03010	#10-32 x 5/16	100	
DUA03012	#10-32 x 3/8	100	
DUA03014	#10-32 x 7/16	100	
DUA03016	#10-32 x 1/2	100	
DUA03018	#10-32 x 9/16	100	
DUA03020	#10-32 x 5/8	100	
DUA03024	#10-32 x 3/4	100	
DUA03028	#10-32 x 7/8	100	
DUA03032	#10-32 x 1	100	
DUA03040	#10-32 x 1 1/4	100	

(continued...)



**SLOTTED FILLISTER MACHINE SCREW (cont.)**

ZINC PLATED

Line: 182-00

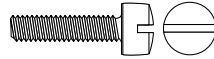

PART NUMBER	SIZE	QTY/BX	LIST PRICE
DUAS03048	#10-32 x 1 1/2	100	
DUAS03056	#10-32 x 1 3/4	100	
DUAS03064	#10-32 x 2	100	
DUAS03072	#10-32 x 2 1/4	100	
DUAS03080	#10-32 x 2 1/2	100	
DUAS03088	#10-32 x 2 3/4	100	
DUAS03096X	#10-32 x 3	100	
DUA21012	#12-24 x 3/8	100	
DUA21016	#12-24 x 1/2	100	
DUA21020	#12-24 x 5/8	100	
DUA21024	#12-24 x 3/4	100	
DUA21028	#12-24 x 7/8	100	
DUA21032	#12-24 x 1	100	
DUA21040	#12-24 x 1 1/4	100	
DUA21048	#12-24 x 1 1/2	100	
DUA21056	#12-24 x 1 3/4	100	
DUA21064	#12-24 x 2	100	
DUA21080	#12-24 x 2 1/2	100	
DUA21096	#12-24 x 3	100	
DUA04008	1/4-20 x 1/4	100	
DUA04012	1/4-20 x 3/8	100	
DUA04016	1/4-20 x 1/2	100	
DUA04020	1/4-20 x 5/8	100	
DUA04024	1/4-20 x 3/4	100	
DUA04028	1/4-20 x 7/8	100	
DUA04032	1/4-20 x 1	100	
DUA04036	1/4-20 x 1 1/8	100	
DUA04040	1/4-20 x 1 1/4	100	
DUA04048	1/4-20 x 1 1/2	100	
DUA04056	1/4-20 x 1 3/4	100	
DUA04064	1/4-20 x 2	100	
DUA04072	1/4-20 x 2 1/4	50	
DUA04080	1/4-20 x 2 1/2	50	
DUA04088	1/4-20 x 2 3/4	50	
DUA04096	1/4-20 x 3	50	
DUAS04032	1/4-28 x 1	100	
DUA05016	5/16-18 x 1/2	100	
DUA05020	5/16-18 x 5/8	100	
DUA05024	5/16-18 x 3/4	100	
DUA05032	5/16-18 x 1	100	
DUA05040	5/16-18 x 1 1/4	100	
DUA05048	5/16-18 x 1 1/2	100	
DUA05056	5/16-18 x 1 3/4	50	
DUA05064	5/16-18 x 2	50	

(continued...)

**SLOTTED FILLISTER MACHINE SCREW (cont.)**

ZINC PLATED

Line: 182-00

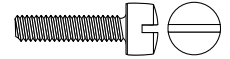

PART NUMBER	SIZE	QTY/BX	LIST PRICE
DUA06024	3/8-16 x 3/4	50	
DUA06032	3/8-16 x 1	50	
DUA06040	3/8-16 x 1 1/4	50	
DUA06048	3/8-16 x 1 1/2	50	
DUA06072X	3/8-16 x 2 1/4	50	
DUA06080X	3/8-16 x 2 1/2	50	

**SLOTTED BINDING MACHINE SCREW**

ZINC PLATED

Line: 182-01

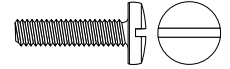

PART NUMBER	SIZE	QTY/BX	LIST PRICE
JVZ22006	#2-56 x 3/16	100	
JVZ22016	#2-56 x 1/2	100	
JVZ22024	#2-56 x 3/4	100	
JVZ44006	#4-40 x 3/16	100	
JVZ44008	#4-40 x 1/4	100	
JVZ44010	#4-40 x 5/16	100	
JVZ44012	#4-40 x 3/8	100	
JVZ44014	#4-40 x 7/16	100	
JVZ44016	#4-40 x 1/2 (Undercut)	100	
JVZ44020	#4-40 x 5/8	100	
JVZ44024	#4-40 x 3/4	100	
JVZ44032	#4-40 x 1	100	
JVZ55008	#5-40 x 1/4	100	
JVZ66006	#6-32 x 3/16	100	
JVZ66008	#6-32 x 1/4 (Undercut)	100	
JVZ66010	#6-32 x 5/16	100	
JVZ66012	#6-32 x 3/8	100	
JVZ66014	#6-32 x 7/16	100	
JVZ66016	#6-32 x 1/2	100	
JVZ66020	#6-32 x 5/8	100	
JVZ66024	#6-32 x 3/4 (Undercut)	100	
JVZ66028	#6-32 x 7/8	100	
JVZ66032	#6-32 x 1	100	
JVZ66040	#6-32 x 1 1/4	100	
JVZ66048	#6-32 x 1 1/2	100	
JVZ88006	#8-32 x 3/16	100	
JVZ88008	#8-32 x 1/4 (Undercut)	100	
JVZ88010	#8-32 x 5/16 (Undercut)	100	
JVZ88012	#8-32 x 3/8 (Undercut)	100	
JVZ88016	#8-32 x 1/2 (Undercut)	100	
JVZ88020	#8-32 x 5/8	100	
JVZ88024	#8-32 x 3/4 (Undercut)	100	
JVZ88028	#8-32 x 7/8	100	
JVZ88032	#8-32 x 1 (Undercut)	100	

(continued...)

## SLOTTED BINDING MACHINE SCREW (cont.)

ZINC PLATED

Line: 182-01

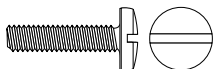

PART NUMBER	SIZE	QTY/BX	LIST PRICE
JVZ88040	#8-32 x 1 1/4	100	
JVZ88048	#8-32 x 1 1/2	100	
JVZ88064	#8-32 x 2	100	
JVZ03008	#10-24 x 1/4	100	
JVZ03010	#10-24 x 5/16	100	
JVZ03012	#10-24 x 3/8	100	
JVZ03016	#10-24 x 1/2	100	
JVZ03020	#10-24 x 5/8	100	
JVZ03024	#10-24 x 3/4	100	
JVZ03028	#10-24 x 7/8	100	
JVZ03032	#10-24 x 1	100	
JVZ03040	#10-24 x 1 1/4	100	
JVZ03048	#10-24 x 1 1/2	100	
JVZ03064	#10-24 x 2	100	
JVZS03008	#10-32 x 1/4	100	
JVZS03010	#10-32 x 5/16	100	
JVZS03012	#10-32 x 3/8	100	
JVZS03014	#10-32 x 7/16	100	
JVZS03016	#10-32 x 1/2 (Undercut)	100	
JVZS03020	#10-32 x 5/8	100	
JVZS03024	#10-32 x 3/4 (Undercut)	100	
JVZS03028	#10-32 x 7/8	100	
JVZS03032	#10-32 x 1	100	
JVZS03040	#10-32 x 1 1/4	100	
JVZS03048	#10-32 x 1 1/2	100	
JVZS03064	#10-32 x 2	100	
JVZ04012	1/4-20 x 3/8	100	
JVZ04016	1/4-20 x 1/2	100	
JVZ04020	1/4-20 x 5/8	100	
JVZ04024	1/4-20 x 3/4	100	
JVZ04028	1/4-20 x 7/8	100	
JVZ04032	1/4-20 x 1	100	
JVZ04040	1/4-20 x 1 1/4	100	
JVZ04048	1/4-20 x 1 1/2	100	

## SLOTTED ROUND STOVE BOLT

WITH NUTS INCLUDED, ZINC PLATED

Line: 184-01

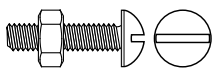

PART NUMBER	SIZE	QTY/BX	LIST PRICE
JDS55016	#5-40 x 1/2	100	
JDS55024	#5-40 x 3/4	100	
JDS55032	#5-40 x 1	100	
JDS55048	#5-40 x 1 1/2	100	
JDS66012	#6-32 x 3/8	100	
JDS66016	#6-32 x 1/2	100	

(continued...)

## SLOTTED ROUND STOVE BOLT (cont.)

WITH NUTS INCLUDED, ZINC PLATED

Line: 184-01

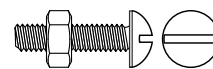

PART NUMBER	SIZE	QTY/BX	LIST PRICE
JDS66020	#6-32 x 5/8	100	
JDS66024	#6-32 x 3/4	100	
JDS66028	#6-32 x 7/8	100	
JDS66032	#6-32 x 1	100	
JDS66040	#6-32 x 1 1/4	100	
JDS66048	#6-32 x 1 1/2	100	
JDS66056	#6-32 x 1 3/4	100	
JDS66064	#6-32 x 2	100	
JDS66080	#6-32 x 2 1/2	100	
JDS66096	#6-32 x 3	100	
JDS88012	#8-32 x 3/8	100	
JDS88016	#8-32 x 1/2	100	
JDS88020	#8-32 x 5/8	100	
JDS88024	#8-32 x 3/4	100	
JDS88028	#8-32 x 7/8	100	
JDS88032	#8-32 x 1	100	
JDS88040	#8-32 x 1 1/4	100	
JDS88048	#8-32 x 1 1/2	100	
JDS88056	#8-32 x 1 3/4	100	
JDS88064	#8-32 x 2	100	
JDS88080	#8-32 x 2 1/2	100	
JDS88096	#8-32 x 3	100	
JDS03012	#10-24 x 3/8	100	
JDS03016	#10-24 x 1/2	100	
JDS03020	#10-24 x 5/8	100	
JDS03024	#10-24 x 3/4	100	
JDS03028	#10-24 x 7/8	100	
JDS03032	#10-24 x 1	100	
JDS03040	#10-24 x 1 1/4	100	
JDS03048	#10-24 x 1 1/2	100	
JDS03056	#10-24 x 1 3/4	100	
JDS03064	#10-24 x 2	100	
JDS03072	#10-24 x 2 1/4	100	
JDS03080	#10-24 x 2 1/2	50	
JDS03096	#10-24 x 3	50	
JDS03112	#10-24 x 3 1/2	50	
JDS03128	#10-24 x 4	50	
JDS03160	#10-24 x 5	50	
JDS03192	#10-24 x 6	50	
JDS04012	1/4-20 x 3/8	100	
JDS04016	1/4-20 x 1/2	100	
JDS04020	1/4-20 x 5/8	100	
JDS04024	1/4-20 x 3/4	100	
JDS04032	1/4-20 x 1	100	

(continued...)

**SLOTTED ROUND STOVE BOLT** (cont.)

WITH NUTS INCLUDED, ZINC PLATED

Line: 184-01

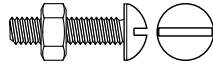

PART NUMBER	SIZE	QTY/BX	LIST PRICE
JDS04040	1/4-20 x 1 1/4	100	
JDS04048	1/4-20 x 1 1/2	100	
JDS04056	1/4-20 x 1 3/4	100	
JDS04064	1/4-20 x 2	100	
JDS04072	1/4-20 x 2 1/4	100	
JDS04080	1/4-20 x 2 1/2	50	
JDS04096	1/4-20 x 3	50	
JDS04112	1/4-20 x 3 1/2	50	
JDS04128	1/4-20 x 4	50	
JDS04144	1/4-20 x 4 1/2	50	
JDS04160	1/4-20 x 5	50	
JDS04192	1/4-20 x 6	50	
JDS05016	5/16-18 x 1/2	100	
JDS05024	5/16-18 x 3/4	100	
JDS05032	5/16-18 x 1	100	
JDS05040	5/16-18 x 1 1/4	100	
JDS05048	5/16-18 x 1 1/2	100	
JDS05056	5/16-18 x 1 3/4	100	
JDS05064	5/16-18 x 2	100	
JDS05072	5/16-18 x 2 1/4	100	
JDS05080	5/16-18 x 2 1/2	50	
JDS05096	5/16-18 x 3	50	
JDS05112	5/16-18 x 3 1/2	50	
JDS05128	5/16-18 x 4	50	
JDS05160	5/16-18 x 5	50	
JDS05192	5/16-18 x 6	50	
JDS06024	3/8-16 x 3/4	100	
JDS06032	3/8-16 x 1	100	
JDS06040	3/8-16 x 1 1/4	100	
JDS06048	3/8-16 x 1 1/2	100	
JDS06056	3/8-16 x 1 3/4	100	
JDS06064	3/8-16 x 2	50	
JDS06080	3/8-16 x 2 1/2	50	
JDS06096	3/8-16 x 3	50	
JDS06112	3/8-16 x 3 1/2	50	
JDS06128	3/8-16 x 4	50	
JDS06160	3/8-16 x 5	50	
JDS06192	3/8-16 x 6	50	
JDS08032	1/2-13 x 1	50	
JDS08064	1/2-13 x 2	50	

**SLOTTED FLAT STOVE BOLT**

WITH NUTS INCLUDED, ZINC PLATED

Line: 184-02

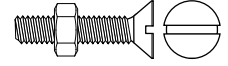

PART NUMBER	SIZE	QTY/BX	LIST PRICE
JES66024	#6-32 3/4	100	
JES66040	#6-32 1 1/4	100	
JES66012	#6-32 x 3/8	100	
JES66016	#6-32 x 1/2	100	
JES66020	#6-32 x 5/8	100	
JES66032	#6-32 x 1	100	
JES66048	#6-32 x 1 1/2	100	
JES66056	#6-32 x 1 3/4	100	
JES66064	#6-32 x 2	100	
JES88016	#8-32 x 1/2	100	
JES88020	#8-32 x 5/8	100	
JES88024	#8-32 x 3/4	100	
JES88032	#8-32 x 1	100	
JES88040	#8-32 x 1 1/4	100	
JES88048	#8-32 x 1 1/2	100	
JES88064	#8-32 x 2	100	
JES88080	#8-32 x 2 1/2	100	
JES88096	#8-32 x 3	100	
JES03012	#10-24 x 3/8	100	
JES03016	#10-24 x 1/2	100	
JES03020	#10-24 x 5/8	100	
JES03024	#10-24 x 3/4	100	
JES03028	#10-24 x 7/8	100	
JES03032	#10-24 x 1	100	
JES03040	#10-24 x 1 1/4	100	
JES03048	#10-24 x 1 1/2	100	
JES03056	#10-24 x 1 3/4	100	
JES03064	#10-24 x 2	100	
JES03072	#10-24 x 2 1/4	100	
JES03080	#10-24 x 2 1/2	50	
JES03088	#10-24 x 2 3/4	50	
JES03096	#10-24 x 3	50	
JES03112	#10-24 x 3 1/2	50	
JES03128	#10-24 x 4	50	
JES03144	#10-24 x 4 1/2	50	
JES03160	#10-24 x 5	50	
JES03192	#10-24 x 6	50	
JES04012	1/4-20 x 3/8	100	
JES04016	1/4-20 x 1/2	100	
JES04020	1/4-20 x 5/8	100	
JES04024	1/4-20 x 3/4	100	
JES04028	1/4-20 x 7/8	100	
JES04032	1/4-20 x 1	100	
JES04040	1/4-20 x 1 1/4	100	

(continued...)

**SLOTTED FLAT STOVE BOLT** (cont.)

WITH NUTS INCLUDED, ZINC PLATED

Line: 184-02

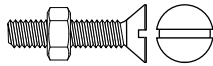

PART NUMBER	SIZE	QTY/BX	LIST PRICE
JES04048	1/4-20 x 1 1/2	100	
JES04056	1/4-20 x 1 3/4	100	
JES04064	1/4-20 x 2	100	
JES04072	1/4-20 x 2 1/4	100	
JES04080	1/4-20 x 2 1/2	50	
JES04088	1/4-20 x 2 3/4	100	
JES04096	1/4-20 x 3	50	
JES04112	1/4-20 x 3 1/2	50	
JES04128	1/4-20 x 4	50	
JES04144	1/4-20 x 4 1/2	100	
JES04160	1/4-20 x 5	50	
JES04176	1/4-20 x 5 1/2	50	
JES04192	1/4-20 x 6	50	
JES05024	5/16-18 x 3/4	100	
JES05032	5/16-18 x 1	100	
JES05040	5/16-18 x 1 1/4	100	
JES05048	5/16-18 x 1 1/2	100	
JES05056	5/16-18 x 1 3/4	100	
JES05064	5/16-18 x 2	100	
JES05080	5/16-18 x 2 1/2	50	
JES05096	5/16-18 x 3	50	
JES05112	5/16-18 x 3 1/2	50	
JES05128	5/16-18 x 4	50	
JES05160	5/16-18 x 5	50	
JES05192	5/16-18 x 6	50	
JES06032	3/8-16 x 1	100	
JES06040	3/8-16 x 1 1/4	100	
JES06048	3/8-16 x 1 1/2	100	
JES06064	3/8-16 x 2	50	
JES06080	3/8-16 x 2 1/2	50	
JES06096	3/8-16 x 3	50	
JES06112	3/8-16 x 3 1/2	50	
JES06128	3/8-16 x 4	50	
JES06160	3/8-16 x 5	50	
JES06192	3/8-16 x 6	50	
JES08032	1/2-13 x 1	50	
JES08048	1/2-13 x 1 1/2	50	
JES08064	1/2-13 x 2	50	
JES08080	1/2-13 x 2 1/2	50	
JES08096	1/2-13 x 3	25	

**COMBO ROUND MACHINE SCREW**

SLOTTED/PHILLIPS DRIVE, ZINC PLATED

Line: 184-10

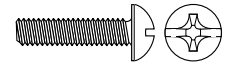

PART NUMBER	SIZE	QTY/BX	LIST PRICE
BZL66012	#6-32 x 3/8	100	
BZL66016	#6-32 x 1/2	100	
BZL66024	#6-32 x 3/4	100	
BZL66032	#6-32 x 1	100	
BZL66040	#6-32 x 1 1/4	100	
BZL66048	#6-32 x 1 1/2	100	
BZL66064	#6-32 x 2	100	
BZL66080	#6-32 x 2 1/2	100	
BZL66096	#6-32 x 3	100	
BZL66128	#6-32 x 4	100	
BZL88008	#8-32 x 1/4	100	
BZL88012	#8-32 x 3/8	100	
BZL88016	#8-32 x 1/2	100	
BZL88020	#8-32 x 5/8	100	
BZL88024	#8-32 x 3/4	100	
BZL88032	#8-32 x 1	100	
BZL88040	#8-32 x 1 1/4	100	
BZL88048	#8-32 x 1 1/2	100	
BZL88064	#8-32 x 2	100	
BZL88080	#8-32 x 2 1/2	100	
BZL88096	#8-32 x 3	100	
BZL88128	#8-32 x 4	100	
BZL03012	#10-24 x 3/8	100	
BZL03016	#10-24 x 1/2	100	
BZL03024	#10-24 x 3/4	100	
BZL03032	#10-24 x 1	100	
BZL03040	#10-24 x 1 1/4	100	
BZL03048	#10-24 x 1 1/2	100	
BZL03064	#10-24 x 2	100	
BZL03080	#10-24 x 2 1/2	100	
BZL03096	#10-24 x 3	100	
BZL03128	#10-24 x 4	100	
BZL03192	#10-24 x 6	100	
BZLS03012	#10-32 x 3/8	100	
BZLS03016	#10-32 x 1/2	100	
BZLS03020	#10-32 x 5/8	100	
BZLS03024	#10-32 x 3/4	100	
BZLS03032	#10-32 x 1	100	
BZLS03040	#10-32 x 1 1/4	100	
BZLS03048	#10-32 x 1 1/2	100	
BZLS03064	#10-32 x 2	100	
BZLS03096	#10-32 x 3	100	
BZL04012	1/4-20 x 3/8	100	
BZL04016	1/4-20 x 1/2	100	

(continued...)

**COMBO ROUND MACHINE SCREW (cont.)**

SLOTTED/PHILLIPS DRIVE, ZINC PLATED

Line: 184-10

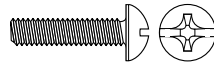

PART NUMBER	SIZE	QTY/BX	LIST PRICE
BZL04024	1/4-20 x 3/4	100	
BZL04032	1/4-20 x 1	100	
BZL04040	1/4-20 x 1 1/4	100	
BZL04048	1/4-20 x 1 1/2	100	
BZL04064	1/4-20 x 2	100	
BZL04080	1/4-20 x 2 1/2	100	
BZL04096	1/4-20 x 3	100	
BZL04128	1/4-20 x 4	100	
BZL04192	1/4-20 x 6	100	

**COMBO TRUSS MACHINE SCREW**

SLOTTED/PHILLIPS DRIVE, ZINC PLATED

Line: 184-12

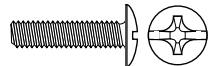

PART NUMBER	SIZE	QTY/BX	LIST PRICE
CCX88012	#8-32 x 3/8	200	
CCX88016	#8-32 x 1/2	200	
CCX88020	#8-32 x 5/8	200	
CCX88024	#8-32 x 3/4	200	
CCX88028	#8-32 x 7/8	200	
CCX88032	#8-32 x 1	200	
CCX88036	#8-32 x 1 1/8	200	
CCX88040	#8-32 x 1 1/4	200	
CCX88044	#8-32 x 1 3/8	200	
CCX88048	#8-32 x 1 1/2	200	
CCX88052	#8-32 x 1 5/8	200	
CCX88056	#8-32 x 1 3/4	200	
CCX88060	#8-32 x 1 7/8	200	
CCX88064	#8-32 x 2	200	

**COMBO TRUSS BREAKAWAY MACHINE SCREW**

SLOTTED/PHILLIPS DRIVE, ZINC PLATED

Line: 184-12

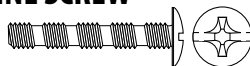

PART NUMBER	SIZE	QTY/BX	LIST PRICE
CCX04045MU	M4 x 45mm (4 Lengths)	200	
CCX88056U	#8-32 x 1 3/4 (4 Lengths)	200	

**PHILLIPS ROUND MACHINE SCREW**

ZINC PLATED

Line: 185-00

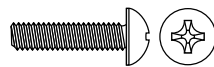

PART NUMBER	SIZE	QTY/BX	LIST PRICE
DVA22008	#2-56 x 1/4	100	
DVA22010	#2-56 x 5/16	100	
DVA22012	#2-56 x 3/8	100	
DVA22016	#2-56 x 1/2	100	
DVA22024	#2-56 x 3/4	100	
DVA33008	#3-48 x 1/4	100	
DVA33010	#3-48 x 5/16	100	

(continued...)

**PHILLIPS ROUND MACHINE SCREW (cont.)**

ZINC PLATED

Line: 185-00

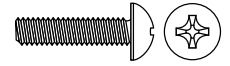

PART NUMBER	SIZE	QTY/BX	LIST PRICE
DVA33012	#3-48 x 3/8	100	
DVA33016	#3-48 x 1/2	100	
DVA33020	#3-48 x 5/8	100	
DVA33024	#3-48 x 3/4	100	
DVA44006	#4-40 x 3/16	100	
DVA44008	#4-40 x 1/4	100	
DVA44010	#4-40 x 5/16	100	
DVA44012	#4-40 x 3/8	100	
DVA44014	#4-40 x 7/16	100	
DVA44016	#4-40 x 1/2	100	
DVA44020	#4-40 x 5/8	100	
DVA44024	#4-40 x 3/4	100	
DVA44028	#4-40 x 7/8	100	
DVA44032	#4-40 x 1	100	
DVA44040	#4-40 x 1 1/4	100	
DVA55010	#5-40 x 5/16	100	
DVA55012	#5-40 x 3/8	100	
DVA55016	#5-40 x 1/2	100	
DVA55020	#5-40 x 5/8	100	
DVA66008	#6-32 x 1/4	100	
DVA66010	#6-32 x 5/16	100	
DVA66012	#6-32 x 3/8	100	
DVA66014	#6-32 x 7/16	100	
DVA66016	#6-32 x 1/2	100	
DVA66020	#6-32 x 5/8	100	
DVA66024	#6-32 x 3/4	100	
DVA66028	#6-32 x 7/8	100	
DVA66032	#6-32 x 1	100	
DVA66040	#6-32 x 1 1/4	100	
DVA66048	#6-32 x 1 1/2	100	
DVA66056	#6-32 x 1 3/4	100	
DVA66064	#6-32 x 2	100	
DVA88008	#8-32 x 1/4	100	
DVA88010	#8-32 x 5/16	100	
DVA88012	#8-32 x 3/8	100	
DVA88016	#8-32 x 1/2	100	
DVA88020	#8-32 x 5/8	100	
DVA88024	#8-32 x 3/4	100	
DVA88028	#8-32 x 7/8	100	
DVA88032	#8-32 x 1	100	
DVA88040	#8-32 x 1 1/4	100	
DVA88048	#8-32 x 1 1/2	100	
DVA88056	#8-32 x 1 3/4	100	
DVA88064	#8-32 x 2	100	

(continued...)

**PHILLIPS ROUND MACHINE SCREW (cont.)**

ZINC PLATED

Line: 185-00

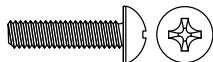

PART NUMBER	SIZE	QTY/BX	LIST PRICE
DVA03008	#10-24 x 1/4	100	
DVA03010	#10-24 x 5/16	100	
DVA03012	#10-24 x 3/8	100	
DVA03014	#10-24 x 7/16	100	
DVA03016	#10-24 x 1/2	100	
DVA03020	#10-24 x 5/8	100	
DVA03024	#10-24 x 3/4	100	
DVA03028	#10-24 x 7/8	100	
DVA03032	#10-24 x 1	100	
DVA03040	#10-24 x 1 1/4	100	
DVA03048	#10-24 x 1 1/2	100	
DVA03056	#10-24 x 1 3/4	100	
DVA03064	#10-24 x 2	100	
DVA03080	#10-24 x 2 1/2	100	
DVA03096	#10-24 x 3	100	
DVAS03008	#10-32 x 1/4	100	
DVAS03010	#10-32 x 5/16	100	
DVAS03012	#10-32 x 3/8	100	
DVAS03014	#10-32 x 7/16	100	
DVAS03016	#10-32 x 1/2	100	
DVAS03020	#10-32 x 5/8	100	
DVAS03024	#10-32 x 3/4	100	
DVAS03028	#10-32 x 7/8	100	
DVAS03032	#10-32 x 1	100	
DVAS03040	#10-32 x 1 1/4	100	
DVAS03048	#10-32 x 1 1/2	100	
DVAS03056	#10-32 x 1 3/4	100	
DVAS03064	#10-32 x 2	100	
DVAS03080	#10-32 x 2 1/2	100	
DVAS03096	#10-32 x 3	100	
DVA21012	#12-24 x 3/8	100	
DVA21016	#12-24 x 1/2	100	
DVA21020	#12-24 x 5/8	100	
DVA21024	#12-24 x 3/4	100	
DVA21032	#12-24 x 1	100	
DVA21040	#12-24 x 1 1/4	100	
DVA21048	#12-24 x 1 1/2	100	
DVA04008	1/4-20 x 1/4	100	
DVA04012	1/4-20 x 3/8	100	
DVA04014	1/4-20 x 7/16	100	
DVA04016	1/4-20 x 1/2	100	
DVA04020	1/4-20 x 5/8	100	
DVA04024	1/4-20 x 3/4	100	
DVA04028	1/4-20 x 7/8	100	

(continued...)

**PHILLIPS ROUND MACHINE SCREW (cont.)**

ZINC PLATED

Line: 185-00

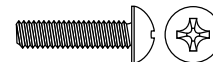

PART NUMBER	SIZE	QTY/BX	LIST PRICE
DVA04032	1/4-20 x 1	100	
DVA04040	1/4-20 x 1 1/4	100	
DVA04048	1/4-20 x 1 1/2	100	
DVA04056	1/4-20 x 1 3/4	100	
DVA04064	1/4-20 x 2	100	
DVA04072X	1/4-20 x 2 1/4	100	
DVA04080	1/4-20 x 2 1/2	100	
DVA04096	1/4-20 x 3	100	
DVA05024	5/16-18 x 3/4	100	
DVA05032	5/16-18 x 1	100	
DVA05040	5/16-18 x 1 1/4	100	
DVA05048	5/16-18 x 1 1/2	50	
DVA05064	5/16-18 x 2	50	

**PHILLIPS FLAT MACHINE SCREW**

ZINC PLATED

Line: 186-00

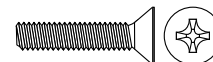

PART NUMBER	SIZE	QTY/BX	LIST PRICE
DWA22006	#2-56 x 3/16	100	
DWA22008	#2-56 x 1/4	100	
DWA22010	#2-56 x 5/16	100	
DWA22012	#2-56 x 3/8	100	
DWA22014	#2-56 x 7/16	100	
DWA22016	#2-56 x 1/2	100	
DWA22020	#2-56 x 5/8	100	
DWA22024	#2-56 x 3/4	100	
DWA33008	#3-48 x 1/4	100	
DWA33010	#3-48 x 5/16	100	
DWA33012	#3-48 x 3/8	100	
DWA33016	#3-48 x 1/2	100	
DWA33020	#3-48 x 5/8	100	
DWA33024	#3-48 x 3/4	100	
DWA44006	#4-40 x 3/16	100	
DWA44008	#4-40 x 1/4	100	
DWA44010	#4-40 x 5/16	100	
DWA44012	#4-40 x 3/8	100	
DWA44016	#4-40 x 1/2	100	
DWA44020	#4-40 x 5/8	100	
DWA44024	#4-40 x 3/4	100	
DWA44028	#4-40 x 7/8	100	
DWA44032	#4-40 x 1	100	
DWA44040	#4-40 x 1 1/4	100	
DWA44048	#4-40 x 1 1/2	100	
DWA544008	#4-48 x 1/4	100	
DWA55008	#5-40 x 1/4	100	

(continued...)

**PHILLIPS FLAT MACHINE SCREW (cont.)**

ZINC PLATED

Line: 186-00

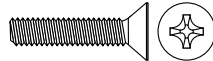

PART NUMBER	SIZE	QTY/BX	LIST PRICE
DWA55010	#5-40 x 5/16	100	
DWA55012	#5-40 x 3/8	100	
DWA55016	#5-40 x 1/2	100	
DWA55020	#5-40 x 5/8	100	
DWA55024	#5-40 x 3/4	100	
DWA55032	#5-40 x 1	100	
DWA66006	#6-32 x 3/16 (Undercut)	100	
DWA66008	#6-32 x 1/4	100	
DWA66010	#6-32 x 5/16	100	
DWA66012	#6-32 x 3/8	100	
DWA66014	#6-32 x 7/16	100	
DWA66016	#6-32 x 1/2	100	
DWA66018	#6-32 x 9/16	100	
DWA66020	#6-32 x 5/8	100	
DWA66024	#6-32 x 3/4	100	
DWA66028	#6-32 x 7/8	100	
DWA66032	#6-32 x 1	100	
DWA66040	#6-32 x 1 1/4	100	
DWA66048	#6-32 x 1 1/2	100	
DWA66064	#6-32 x 2	100	
DWA66080	#6-32 x 2 1/2	100	
DWA66096	#6-32 x 3	100	
DWA88008	#8-32 x 1/4	100	
DWA88010	#8-32 x 5/16	100	
DWA88012	#8-32 x 3/8	100	
DWA88014	#8-32 x 7/16	100	
DWA88016	#8-32 x 1/2	100	
DWA88020	#8-32 x 5/8	100	
DWA88024	#8-32 x 3/4	100	
DWA88028	#8-32 x 7/8	100	
DWA88032	#8-32 x 1	100	
DWA88040	#8-32 x 1 1/4	100	
DWA88048	#8-32 x 1 1/2	100	
DWA88064	#8-32 x 2	100	
DWA88080	#8-32 x 2 1/2	100	
DWA88096	#8-32 x 3	100	
DWA03010	#10-24 x 5/16	100	
DWA03012	#10-24 x 3/8	100	
DWA03014	#10-24 x 7/16	100	
DWA03016	#10-24 x 1/2	100	
DWA03018	#10-24 x 9/16	100	
DWA03020	#10-24 x 5/8	100	
DWA03024	#10-24 x 3/4	100	
DWA03028	#10-24 x 7/8	100	

(continued...)

**PHILLIPS FLAT MACHINE SCREW (cont.)**

ZINC PLATED

Line: 186-00

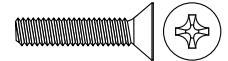

PART NUMBER	SIZE	QTY/BX	LIST PRICE
DWA03032	#10-24 x 1	100	
DWA03040	#10-24 x 1 1/4	100	
DWA03048	#10-24 x 1 1/2	100	
DWA03056	#10-24 x 1 3/4	100	
DWA03064	#10-24 x 2	100	
DWA03080	#10-24 x 2 1/2	100	
DWA03096	#10-24 x 3	100	
DWA03008X	#10-32 x 1/4	100	
DWA03010	#10-32 x 5/16	100	
DWA03012	#10-32 x 3/8	100	
DWA03014	#10-32 x 7/16	100	
DWA03016	#10-32 x 1/2	100	
DWA03020	#10-32 x 5/8	100	
DWA03024	#10-32 x 3/4	100	
DWA03028	#10-32 x 7/8	100	
DWA03032	#10-32 x 1	100	
DWA03040	#10-32 x 1 1/4	100	
DWA03048	#10-32 x 1 1/2	100	
DWA03056	#10-32 x 1 3/4	100	
DWA03064	#10-32 x 2	100	
DWA03080	#10-32 x 2 1/2	100	
DWA03096	#10-32 x 3	100	
DWA21012	#12-24 x 3/8	100	
DWA21016	#12-24 x 1/2	100	
DWA21020	#12-24 x 5/8	100	
DWA21024	#12-24 x 3/4	100	
DWA21028	#12-24 x 7/8	100	
DWA21032	#12-24 x 1	100	
DWA21040	#12-24 x 1 1/4	100	
DWA21048	#12-24 x 1 1/2	100	
DWA04012	1/4-20 x 3/8	100	
DWA04016	1/4-20 x 1/2	100	
DWA04020	1/4-20 x 5/8	100	
DWA04024	1/4-20 x 3/4	100	
DWA04028	1/4-20 x 7/8	100	
DWA04032	1/4-20 x 1	100	
DWA04040	1/4-20 x 1 1/4	100	
DWA04048	1/4-20 x 1 1/2	100	
DWA04056	1/4-20 x 1 3/4	100	
DWA04064	1/4-20 x 2	100	
DWA04072	1/4-20 x 2 1/4	100	
DWA04080	1/4-20 x 2 1/2	100	
DWA04096	1/4-20 x 3	100	
DWA04112X	1/4-20 x 3 1/2	50	

(continued...)

**PHILLIPS FLAT MACHINE SCREW (cont.)**

ZINC PLATED

Line: 186-00

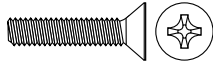

PART NUMBER	SIZE	QTY/BX	LIST PRICE
DWA504016	1/4-28 x 1/2	100	
DWA504024	1/4-28 x 3/4	100	
DWA504032	1/4-28 x 1	100	
DWA05016	5/16-18 x 1/2	100	
DWA05020X	5/16-18 x 5/8	100	
DWA05024	5/16-18 x 3/4	100	
DWA05032	5/16-18 x 1	100	
DWA05040X	5/16-18 x 1 1/4	100	
DWA05048	5/16-18 x 1 1/2	100	
DWA05056	5/16-18 x 1 3/4	100	
DWA05064	5/16-18 x 2	100	
DWA05080	5/16-18 x 2 1/2	50	
DWA05096	5/16-18 x 3	50	
DWA06032X	3/8-16 x 1	50	
DWA06040	3/8-16 x 1 1/4	50	
DWA06048	3/8-16 x 1 1/2	50	
DWA06064	3/8-16 x 2	100	
DWA06080	3/8-16 x 2 1/2	100	
DWA06096	3/8-16 x 3	50	

**PHILLIPS FLAT MACHINE SCREW**

100° HEAD, ZINC PLATED

Line: 186-01

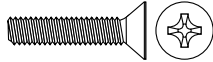

PART NUMBER	SIZE	QTY/BX	LIST PRICE
CFD44016	#4-40 x 1/2	100	
CFD66024	#6-32 x 3/4	100	
CFD66032	#6-32 x 1	100	
CFD88024	#8-32 x 3/4	100	
CFD88032	#8-32 x 1	100	
CFD03032	#10-24 x 1	50	
CFD503032	#10-32 x 1	50	
CFD04016	1/4-20 x 1/2	50	
CFD04024	1/4-20 x 3/4	50	
CFD04032	1/4-20 x 1	50	
CFD04040	1/4-20 x 1 1/4	25	
CFD04048	1/4-20 x 1 1/2	25	

**PHILLIPS TRUSS MACHINE SCREW**

ZINC PLATED

Line: 187-00

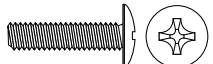

PART NUMBER	SIZE	QTY/BX	LIST PRICE
DXA22008	#2-56 x 1/4	100	
DXA22012	#2-56 x 3/8	100	
DXA22016	#2-56 x 1/2	100	
DXA33008	#3-48 x 1/4	100	
DXA33012	#3-48 x 3/8	100	

(continued...)

**PHILLIPS TRUSS MACHINE SCREW (cont.)**

ZINC PLATED

Line: 187-00

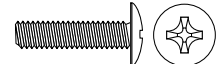

PART NUMBER	SIZE	QTY/BX	LIST PRICE
DXA33016	#3-48 x 1/2	100	
DXA44008	#4-40 x 1/4	100	
DXA44010	#4-40 x 5/16	100	
DXA44012	#4-40 x 3/8	100	
DXA44016	#4-40 x 1/2	100	
DXA44020	#4-40 x 5/8	100	
DXA44024	#4-40 x 3/4	100	
DXA44032	#4-40 x 1	100	
DXA55008	#5-40 x 1/4	100	
DXA55032	#5-40 x 1	100	
DXA66008	#6-32 x 1/4	100	
DXA66010	#6-32 x 5/16	100	
DXA66012	#6-32 x 3/8	100	
DXA66016	#6-32 x 1/2	100	
DXA66020	#6-32 x 5/8	100	
DXA66024	#6-32 x 3/4	100	
DXA66028	#6-32 x 7/8	100	
DXA66032	#6-32 x 1	100	
DXA66040	#6-32 x 1 1/4	100	
DXA66048	#6-32 x 1 1/2	100	
DXA88008	#8-32 x 1/4	100	
DXA88010	#8-32 x 5/16	100	
DXA88012	#8-32 x 3/8	100	
DXA88016	#8-32 x 1/2	100	
DXA88018	#8-32 x 9/16	100	
DXA88020	#8-32 x 5/8	100	
DXA88024	#8-32 x 3/4	100	
DXA88028	#8-32 x 7/8	100	
DXA88032	#8-32 x 1	100	
DXA88040	#8-32 x 1 1/4	100	
DXA88048	#8-32 x 1 1/2	100	
DXA88056	#8-32 x 1 3/4	100	
DXA03008	#10-24 x 1/4	100	
DXA03010	#10-24 x 5/16	100	
DXA03012	#10-24 x 3/8	100	
DXA03014	#10-24 x 7/16	100	
DXA03016	#10-24 x 1/2	100	
DXA03020	#10-24 x 5/8	100	
DXA03024	#10-24 x 3/4	100	
DXA03032	#10-24 x 1	100	
DXA03040	#10-24 x 1 1/4	100	
DXA03048	#10-24 x 1 1/2	100	
DXA03064	#10-24 x 2	100	
DXAS03008	#10-32 x 1/4	100	

(continued...)



## PHILLIPS TRUSS MACHINE SCREW (cont.)

ZINC PLATED

Line: 187-00

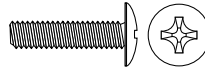

PART NUMBER	SIZE	QTY/BX	LIST PRICE
DXAS03010	#10-32 x 5/16	100	
DXAS03012	#10-32 x 3/8	100	
DXAS03016	#10-32 x 1/2	100	
DXAS03020	#10-32 x 5/8	100	
DXAS03024	#10-32 x 3/4	100	
DXAS03028	#10-32 x 7/8	100	
DXAS03032	#10-32 x 1	100	
DXAS03040	#10-32 x 1 1/4	100	
DXAS03048	#10-32 x 1 1/2	100	
DXA21012	#12-24 x 3/8	100	
DXA21016	#12-24 x 1/2	100	
DXA21024	#12-24 x 3/4	100	
DXA21032	#12-24 x 1	100	
DXA04008	1/4-20 x 1/4	100	
DXA04010X	1/4-20 x 5/16	100	
DXA04012	1/4-20 x 3/8	100	
DXA04016	1/4-20 x 1/2	100	
DXA04020	1/4-20 x 5/8	100	
DXA04024	1/4-20 x 3/4	100	
DXA04028	1/4-20 x 7/8	100	
DXA04032	1/4-20 x 1	100	
DXA04040	1/4-20 x 1 1/4	100	
DXA04048	1/4-20 x 1 1/2	100	
DXA04056	1/4-20 x 1 3/4	100	
DXA04064	1/4-20 x 2	100	
DXA04072	1/4-20 x 2 1/4	50	
DXA04080	1/4-20 x 2 1/2	50	
DXA04096	1/4-20 x 3	100	
DXA05020	5/16-18 x 5/8	100	
DXA05024	5/16-18 x 3/4	100	

## PHILLIPS PAN MACHINE SCREW

ZINC PLATED

Line: 188-00

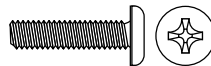

PART NUMBER	SIZE	QTY/BX	LIST PRICE
DYA22006	#2-56 x 3/16	100	
DYA22008	#2-56 x 1/4	100	
DYA22010	#2-56 x 5/16	100	
DYA22012	#2-56 x 3/8	100	
DYA22014	#2-56 x 7/16	100	
DYA22016	#2-56 x 1/2	100	
DYA22020	#2-56 x 5/8	100	
DYA22024	#2-56 x 3/4	100	
DYA22028	#2-56 x 7/8	100	
DYA22032	#2-56 x 1	100	

(continued...)

## PHILLIPS PAN MACHINE SCREW (cont.)

ZINC PLATED

Line: 188-00

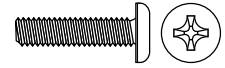

PART NUMBER	SIZE	QTY/BX	LIST PRICE
DYA33004	#3-48 x 1/8	100	
DYA33006	#3-48 x 3/16	100	
DYA33008	#3-48 x 1/4	100	
DYA33010	#3-48 x 5/16	100	
DYA33012	#3-48 x 3/8	100	
DYA33014	#3-48 x 7/16	100	
DYA33016	#3-48 x 1/2	100	
DYA33020	#3-48 x 5/8	100	
DYA33024	#3-48 x 3/4	100	
DYA44006	#4-40 x 3/16	100	
DYA44008	#4-40 x 1/4	100	
DYA44010	#4-40 x 5/16	100	
DYA44012	#4-40 x 3/8	100	
DYA44014X	#4-40 x 7/16	100	
DYA44016	#4-40 x 1/2	100	
DYA44020	#4-40 x 5/8	100	
DYA44024	#4-40 x 3/4	100	
DYA44028	#4-40 x 7/8	100	
DYA44032	#4-40 x 1	100	
DYA44040	#4-40 x 1 1/4	100	
DYA44048	#4-40 x 1 1/2	100	
DYA44056	#4-40 x 1 3/4	100	
DYA44064	#4-40 x 2	100	
DYA55008	#5-40 x 1/4	100	
DYA55010	#5-40 x 5/16	100	
DYA55012	#5-40 x 3/8	100	
DYA55016	#5-40 x 1/2	100	
DYA55020	#5-40 x 5/8	100	
DYA55024	#5-40 x 3/4	100	
DYA55032	#5-40 x 1	100	
DYA66006X	#6-32 x 3/16	100	
DYA66008	#6-32 x 1/4	100	
DYA66010	#6-32 x 5/16	100	
DYA66012	#6-32 x 3/8	100	
DYA66014	#6-32 x 7/16	100	
DYA66016	#6-32 x 1/2	100	
DYA66020	#6-32 x 5/8	100	
DYA66024	#6-32 x 3/4	100	
DYA66028	#6-32 x 7/8	100	
DYA66032	#6-32 x 1	100	
DYA66040	#6-32 x 1 1/4	100	
DYA66048	#6-32 x 1 1/2	100	
DYA66056	#6-32 x 1 3/4	100	
DYA66064	#6-32 x 2	100	

(continued...)

**PHILLIPS PAN MACHINE SCREW (cont.)**

ZINC PLATED

Line: 188-00

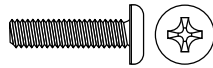

**PHILLIPS PAN MACHINE SCREW (cont.)**

ZINC PLATED

Line: 188-00

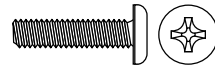

**SCREWS - SECTION 05**

**PAGE 5-28**

PART NUMBER	SIZE	QTY/BX	LIST PRICE
DYA66080	#6-32 x 2 1/2	100	
DYA66096	#6-32 x 3	100	
DYA66128	#6-32 x 4	100	
DYA88006	#8-32 x 3/16	100	
DYA88008	#8-32 x 1/4	100	
DYA88010	#8-32 x 5/16	100	
DYA88012	#8-32 x 3/8	100	
DYA88014	#8-32 x 7/16	100	
DYA88016	#8-32 x 1/2	100	
DYA88020	#8-32 x 5/8	100	
DYA88024	#8-32 x 3/4	100	
DYA88028	#8-32 x 7/8	100	
DYA88032	#8-32 x 1	100	
DYA88040	#8-32 x 1 1/4	100	
DYA88048	#8-32 x 1 1/2	100	
DYA88064	#8-32 x 2	100	
DYA88080	#8-32 x 2 1/2	100	
DYA88096	#8-32 x 3	100	
DYA88128	#8-32 x 4	100	
DYA03008	#10-24 x 1/4	100	
DYA03010	#10-24 x 5/16	100	
DYA03012	#10-24 x 3/8	100	
DYA03014	#10-24 x 7/16	100	
DYA03016	#10-24 x 1/2	100	
DYA03020	#10-24 x 5/8	100	
DYA03024	#10-24 x 3/4	100	
DYA03028	#10-24 x 7/8	100	
DYA03032	#10-24 x 1	100	
DYA03040	#10-24 x 1 1/4	100	
DYA03048	#10-24 x 1 1/2	100	
DYA03056	#10-24 x 1 3/4	100	
DYA03064	#10-24 x 2	100	
DYA03080	#10-24 x 2 1/2	100	
DYA03096	#10-24 x 3	100	
DYA03128	#10-24 x 4	100	
DYAS03008	#10-32 x 1/4	100	
DYAS03010	#10-32 x 5/16	100	
DYAS03012	#10-32 x 3/8	100	
DYAS03014	#10-32 x 7/16	100	
DYAS03016	#10-32 x 1/2	100	
DYAS03020	#10-32 x 5/8	100	
DYAS03024	#10-32 x 3/4	100	
DYAS03028	#10-32 x 7/8	100	
DYAS03032	#10-32 x 1	100	

(continued...)

PART NUMBER	SIZE	QTY/BX	LIST PRICE
DYAS03036	#10-32 x 1 1/8	100	
DYAS03040	#10-32 x 1 1/4	100	
DYAS03048	#10-32 x 1 1/2	100	
DYAS03056	#10-32 x 1 3/4	100	
DYAS03064	#10-32 x 2	100	
DYAS03080	#10-32 x 2 1/2	100	
DYAS03096	#10-32 x 3	100	
DYAS03128	#10-32 x 4	100	
DYA21012	#12-24 x 3/8	100	
DYA21016	#12-24 x 1/2	100	
DYA21020	#12-24 x 5/8	100	
DYA21024	#12-24 x 3/4	100	
DYA21028	#12-24 x 7/8	100	
DYA21032	#12-24 x 1	100	
DYA21040	#12-24 x 1 1/4	100	
DYA21048	#12-24 x 1 1/2	100	
DYA21064	#12-24 x 2	100	
DYA04012	1/4-20 x 3/8	100	
DYA04014	1/4-20 x 7/16	100	
DYA04016	1/4-20 x 1/2	100	
DYA04018X	1/4-20 x 9/16	100	
DYA04020	1/4-20 x 5/8	100	
DYA04024	1/4-20 x 3/4	100	
DYA04028	1/4-20 x 7/8	100	
DYA04032	1/4-20 x 1	100	
DYA04040	1/4-20 x 1 1/4	100	
DYA04048	1/4-20 x 1 1/2	100	
DYA04056	1/4-20 x 1 3/4	100	
DYA04064	1/4-20 x 2	100	
DYA04072	1/4-20 x 2 1/4	100	
DYA04080	1/4-20 x 2 1/2	100	
DYA04088	1/4-20 x 2 3/4	100	
DYA04096	1/4-20 x 3	100	
DYA04112	1/4-20 x 3 1/2	100	
DYA04128	1/4-20 x 4	100	
DYAS04020	1/4-28 x 5/8	100	
DYAS04024	1/4-28 x 3/4	100	
DYA05016	5/16-18 x 1/2	100	
DYA05020	5/16-18 x 5/8	100	
DYA05024	5/16-18 x 3/4	100	
DYA05028	5/16-18 x 7/8	100	
DYA05032	5/16-18 x 1	100	
DYA05040	5/16-18 x 1 1/4	100	
DYA05048	5/16-18 x 1 1/2	100	

(continued...)

## PHILLIPS PAN MACHINE SCREW (cont.)

ZINC PLATED

Line: 188-00

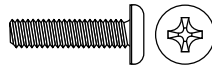

PART NUMBER	SIZE	QTY/BX	LIST PRICE
DYA05056	5/16-18 x 1 3/4	100	
DYA05064	5/16-18 x 2	100	
DYA05080	5/16-18 x 2 1/2	50	
DYA05088	5/16-18 x 2 3/4	50	
DYA05096	5/16-18 x 3	50	
DYA06032YZ	3/8-16 x 1	1	
DYA06064	3/8-16 x 2	50	
DYA06096	3/8-16 x 3	50	

## PHILLIPS OVAL MACHINE SCREW

ZINC PLATED

Line: 189-00

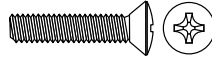

PART NUMBER	SIZE	QTY/BX	LIST PRICE
DZA44008	#4-40 x 1/4	100	
DZA44010	#4-40 x 5/16	100	
DZA44012	#4-40 x 3/8	100	
DZA44016	#4-40 x 1/2	100	
DZA44020	#4-40 x 5/8	100	
DZA44024	#4-40 x 3/4	100	
DZA44032	#4-40 x 1	100	
DZA66008	#6-32 x 1/4	100	
DZA66010	#6-32 x 5/16	100	
DZA66012	#6-32 x 3/8	100	
DZA66016	#6-32 x 1/2	100	
DZA66020	#6-32 x 5/8	100	
DZA66024	#6-32 x 3/4	100	
DZA66028	#6-32 x 7/8	100	
DZA66032	#6-32 x 1	100	
DZA66040	#6-32 x 1 1/4	100	
DZA66048	#6-32 x 1 1/2	100	
DZA88008	#8-32 x 1/4	100	
DZA88012	#8-32 x 3/8	100	
DZA88016	#8-32 x 1/2	100	
DZA88020	#8-32 x 5/8	100	
DZA88024	#8-32 x 3/4	100	
DZA88028	#8-32 x 7/8	100	
DZA88032	#8-32 x 1	100	
DZA88040	#8-32 x 1 1/4	100	
DZA88048	#8-32 x 1 1/2	100	
DZA88056	#8-32 x 1 3/4	100	
DZA88064	#8-32 x 2	100	
DZA03008X	#10-24 x 1/4	100	
DZA03012	#10-24 x 3/8	100	
DZA03016	#10-24 x 1/2	100	
DZA03020	#10-24 x 5/8	100	

(continued...)

## PHILLIPS OVAL MACHINE SCREW (cont.)

ZINC PLATED

Line: 189-00

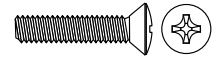

PART NUMBER	SIZE	QTY/BX	LIST PRICE
DZA03024	#10-24 x 3/4	100	
DZA03028	#10-24 x 7/8	100	
DZA03032	#10-24 x 1	100	
DZA03040	#10-24 x 1 1/4	100	
DZA03048	#10-24 x 1 1/2	100	
DZA03056	#10-24 x 1 3/4	100	
DZA03064	#10-24 x 2	100	
DZA03096	#10-24 x 3	100	
DZAS03012	#10-32 x 3/8	100	
DZAS03016	#10-32 x 1/2	100	
DZAS03020	#10-32 x 5/8	100	
DZAS03024	#10-32 x 3/4	100	
DZAS03032	#10-32 x 1	100	
DZAS03040	#10-32 x 1 1/4	100	
DZAS03048	#10-32 x 1 1/2	100	
DZAS03056	#10-32 x 1 3/4	100	
DZAS03064	#10-32 x 2	100	
DZA21012	#12-24 x 3/8	100	
DZA21016	#12-24 x 1/2	100	
DZA21020	#12-24 x 5/8	100	
DZA21024	#12-24 x 3/4	100	
DZA21032	#12-24 x 1	100	
DZA21040	#12-24 x 1 1/4	100	
DZA21048	#12-24 x 1 1/2	100	
DZA21056	#12-24 x 1 3/4	100	
DZA21064	#12-24 x 2	100	
DZA04016	1/4-20 x 1/2	100	
DZA04020	1/4-20 x 5/8	100	
DZA04024	1/4-20 x 3/4	100	
DZA04032	1/4-20 x 1	100	
DZA04040	1/4-20 x 1 1/4	100	
DZA04048	1/4-20 x 1 1/2	100	
DZA04056	1/4-20 x 1 3/4	100	
DZA04064	1/4-20 x 2	100	
DZA04080	1/4-20 x 2 1/2	100	
DZA05024	5/16-18 x 3/4	100	
DZA05032	5/16-18 x 1	100	
DZA05048	5/16-18 x 1 1/2	100	
DZA06032	3/8-16 x 1	50	
DZA06040	3/8-16 x 1 1/4	50	
DZA06048	3/8-16 x 1 1/2	50	

# PHILLIPS FILLISTER MACHINE SCREW

ZINC PLATED

Line: 190-00

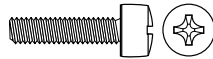

PART NUMBER	SIZE	QTY/BX	LIST PRICE
EAA44008	#4-40 x 1/4	100	
EAA44010	#4-40 x 5/16	100	
EAA44012	#4-40 x 3/8	100	
EAA44016	#4-40 x 1/2	100	
EAA44020	#4-40 x 5/8	100	
EAA44024	#4-40 x 3/4	100	
EAA44028	#4-40 x 7/8	100	
EAA44032	#4-40 x 1	100	
EAA55012	#5-40 x 3/8	100	
EAA55016	#5-40 x 1/2	100	
EAA55020	#5-40 x 5/8	100	
EAA66008	#6-32 x 1/4	100	
EAA66010	#6-32 x 5/16	100	
EAA66012	#6-32 x 3/8	100	
EAA66016	#6-32 x 1/2	100	
EAA66020	#6-32 x 5/8	100	
EAA66024	#6-32 x 3/4	100	
EAA66032	#6-32 x 1	100	
EAA88008	#8-32 x 1/4	100	
EAA88010	#8-32 x 5/16	100	
EAA88012	#8-32 x 3/8	100	
EAA88016	#8-32 x 1/2	100	
EAA88020	#8-32 x 5/8	100	
EAA88024	#8-32 x 3/4	100	
EAA88028	#8-32 x 7/8	100	
EAA88032	#8-32 x 1	100	
EAA88040	#8-32 x 1 1/4	100	
EAA88048	#8-32 x 1 1/2	100	
EAA03008	#10-24 x 1/4	100	
EAA03010	#10-24 x 5/16	100	
EAA03012	#10-24 x 3/8	100	
EAA03016	#10-24 x 1/2	100	
EAA03020	#10-24 x 5/8	100	
EAA03024	#10-24 x 3/4	100	
EAA03028	#10-24 x 7/8	100	
EAA03032	#10-24 x 1	100	
EAA03040	#10-24 x 1 1/4	100	
EAA03048	#10-24 x 1 1/2	100	
EAA03008	#10-32 x 1/4	100	
EAA03010	#10-32 x 5/16	100	
EAA03012	#10-32 x 3/8	100	
EAA03016	#10-32 x 1/2	100	
EAA03020	#10-32 x 5/8	100	
EAA03024	#10-32 x 3/4	100	

(continued...)

# PHILLIPS FILLISTER MACHINE SCREW (cont.)

ZINC PLATED

Line: 190-00

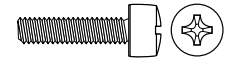

PART NUMBER	SIZE	QTY/BX	LIST PRICE
EAA03028	#10-32 x 7/8	100	
EAA03032	#10-32 x 1	100	
EAA03040	#10-32 x 1 1/4	100	
EAA03048	#10-32 x 1 1/2	100	
EAA21012	#12-24 x 3/8	100	
EAA21024	#12-24 x 3/4	100	
EAA04012	1/4-20 x 3/8	100	
EAA04016	1/4-20 x 1/2	100	
EAA04020	1/4-20 x 5/8	100	
EAA04024	1/4-20 x 3/4	100	
EAA04028	1/4-20 x 7/8	100	
EAA04032	1/4-20 x 1	100	
EAA04040	1/4-20 x 1 1/4	100	
EAA04048	1/4-20 x 1 1/2	100	
EAA05024	5/16-18 x 3/4	100	
EAA05032	5/16-18 x 1	100	

# ONE-WAY SECURITY MACHINE SCREW

TAMPERPROOF, 18-8 STAINLESS STEEL

Line: 190-01

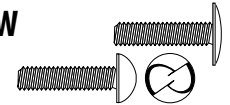

PART NUMBER	SIZE	QTY/BX	LIST PRICE
BDZ66016RMS	#6-32 x 1/2 (Round Hd.)	100	
BDZ88024RMS	#8-32 x 1/2 (Round Hd.)	100	
BDZ88024OMS	#8-32 x 3/4 (Oval Hd.)	100	
BDZ88048RMS	#8-32 x 1 1/2 (Round Hd.)	50	
JJG03016	#10 x 1/2 (Button Hd. - SMS)	100	
JJG03012	#10-24 x 3/8 (Button Hd.)	100	
JJG03024	#10-24 x 3/8 (Button Hd.)	100	
BDZ03016RMS	#10-24 x 1/2 (Round Hd.)	100	
BDZ03032RMS	#10-24 x 1 (Round Hd.)	100	
BDZ03040	#10-32 x 1 1/4 (Round Hd.)	100	
BDZ04048RMS	1/4-20 x 1 1/2 (Round Hd.)	50	
BDZ06064RMS	3/8-16 x 2 (Round Hd.)	100	

# ONE-WAY ROUND HD SECURITY TAPPING SCREW

TAMPERPROOF, 18-8 STAINLESS STEEL

Line: 190-02

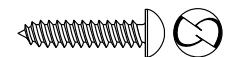

PART NUMBER	SIZE	QTY/BX	LIST PRICE
BDZ880240TS	#8 x 3/4 (Oval Hd.)	100	
BDZ88032RTS	#8 x 1	100	
BDZ03032RTS	#10 x 1	100	
BDZ03048RTS	#10 x 1 1/2	100	
BDZ03064RTS	#10 x 2	100	
BDZ04024RTS	#14 x 3/4	100	
BDZ04032RTS	#14 x 1	100	
BDZ04048RTS	#14 x 1 1/2	100	
BDZ04064RTS	#14 x 2	100	

## SNAKE EYE SPANNER SECURITY TAPPING SCREW

TAMPERPROOF, 18-8 STAINLESS STEEL

Line: 190-03

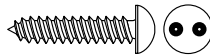

PART NUMBER	SIZE	QTY/BX	LIST PRICE
BED66016PTS	#6 x 1/2 (Pan Hd.)	100	
BED66024PTS	#6 x 3/4 (Pan Hd.)	100	
BED66032PTS	#6 x 1 (Pan Hd.)	100	
BED88016FTS	#8 x 1/2 (Flat Hd.)	100	
BED88024PTS	#8 x 3/4 (Pan Hd.)	100	
BED88032PTS	#8 x 1 (Pan Hd.)	100	
BED88032PTMS	#8-32 x 1 (Pan Hd.)	100	
BED03024PTS	#10 x 3/4 (Pan Hd.)	100	
BED03032PTS	#10 x 1 (Pan Hd.)	100	
BED03032TTS	#10 x 1 (Truss Hd.)	100	
BED030400TS	#10 x 1 1/4 (Oval Hd.)	100	
BED21024PTS	#12 x 3/4 (Pan Hd.)	100	
BED21032PTS	#12 x 1 (Pan Hd.)	100	
BED21040FTS	#12 x 1 1/4 (Flat Hd.)	100	

## SNAKE EYE SPANNER SECURITY MACHINE SCREW

TAMPERPROOF, 18-8 STAINLESS STEEL

Line: 190-04

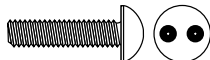

PART NUMBER	SIZE	QTY/BX	LIST PRICE
BED44016PTMS	#4-40 x 1/2 (Pan Hd.)	100	
BED80468YEL	#6/#8 (One-Way)	1	
BED66016	#6-32 x 1/2 (Oval Hd.)	100	
BED66024PTMS	#6-32 x 3/4 (Pan Hd.)	100	
BED66032PTMS	#6-32 x 1 (Pan Hd.)	100	
BED88024TMS	#8-32 x 3/4 (Truss Hd.)	100	
BED8071012RED	#10/#12 (One-Way)	1	
BED03024PMS	#10-24 x 3/4 (Pan Hd.)	100	
BED03032FMS	#10-24 x 1 (Flat Hd.)	100	
BED8104BLK	1/4 (One-Way)	1	
BED04048OMS	1/4-20 x 1 1/2 (Oval Hd.)	100	

## PIN TORX SECURITY TAPPING SCREW

TAMPERPROOF - STAINLESS STEEL

Line: 190-05

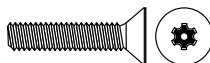

PART NUMBER	SIZE	QTY/BX	LIST PRICE
BPK66012F	#6-32 x 3/8 (Flat Hd.)	25	
BPK66016BU	#6-32 x 1/2 (Button Hd.)	25	
BPK66016F	#6-32 x 1/2 (Flat Hd.)	25	
BPK66024BU	#6-32 x 3/4 (Button Hd.)	25	
BPK66024F	#6-32 x 3/4 (Flat Hd.)	25	
BPK66032BU	#6-32 x 1 (Button Hd.)	25	
BPK66040BU	#6-32 x 1 1/4 (Button Hd.)	25	
BPK88016BU	#8-32 x 1/2 (Button Hd.)	25	
BPK88016F	#8-32 x 1/2 (Flat Hd.)	25	
BPK88024BU	#8-32 x 3/4 (Button Hd.)	25	
BPK88024F	#8-32 x 3/4 (Flat Hd.)	25	

(continued...)

## PIN TORX SECURITY TAPPING SCREW (cont.)

TAMPERPROOF, 18-8 STAINLESS STEEL

Line: 190-05

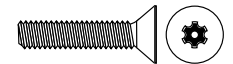

PART NUMBER	SIZE	QTY/BX	LIST PRICE
BPK88032BU	#8-32 x 1 (Button Hd.)	25	
BPK88032F	#8-32 x 1 (Flat Hd.)	25	
BPK03016BU	#10-24 x 1/2 (Button Hd.)	25	
BPK03016F	#10-24 x 1/2 (Flat Hd.)	25	
BPK03024BU	#10-24 x 3/4 (Button Hd.)	25	
BPK03024F	#10-24 x 3/4 (Flat Hd.)	25	
BPK03032BU	#10-24 x 1 (Button Hd.)	25	
BPK03032F	#10-24 x 1 (Flat Hd.)	25	
BPK03040BU	#10-24 x 1 1/4 (Button Hd.)	20	
BPK03040F	#10-24 x 1 1/4 (Flat Hd.)	20	
BPKS03016BU	#10-32 x 1/2 (Button Hd.)	25	
BPKS03016F	#10-32 x 1/2 (Flat Hd.)	25	
BPKS03024BU	#10-32 x 3/4 (Button Hd.)	25	
BPKS03024F	#10-32 x 3/4 (Flat Hd.)	25	
BPKS03032BU	#10-32 x 1 (Button Hd.)	25	
BPKS03032F	#10-32 x 1 (Flat Hd.)	25	
BPK21016UCF	#12-24 x 1/2 U/C (Flat Hd.)	25	
BPK21024F	#12-24 x 3/4 (Flat Hd.)	25	
BPK04016UCF	1/4-20 x 1/2 U/C (Flat Hd.)	20	
BPK04020F	1/4-20 x 5/8 (Flat Hd.)	20	
BPK04024BU	1/4-20 x 3/4 (Button Hd.)	20	
BPK04024F	1/4-20 x 3/4 (Flat Hd.)	20	
BPK04032BU	1/4-20 x 1 (Button Hd.)	20	
BPK04032F	1/4-20 x 1 (Flat Hd.)	20	
BPK04048BU	1/4-20 x 1 1/2 (Button Hd.)	20	
BPKS04024BU	1/4-28 x 3/4 (Button Hd.)	25	
BPK06024BU	3/8-16 x 3/4 (Button Hd.)	25	

## PIN TORX TAPPING SCREW

TAMPERPROOF SECURITY SCREW- STAINLESS STEEL

Line: 190-08

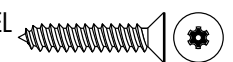

PART NUMBER	SIZE	QTY/BX	LIST PRICE
CDF66016BU	#6 x 1/2 (Button Hd.)	25	
CDF66024BU	#6 x 3/4 (Button Hd.)	25	
CDF66024F	#6 x 3/4 (Flat Hd.)	25	
CDF66032BU	#6 x 1 (Button Hd.)	25	
CDF66032F	#6 x 1 (Flat Hd.)	25	
CDF88016BU	#8 x 1/2 (Button Hd.)	25	
CDF88024BU	#8 x 3/4 (Button Hd.)	25	
CDF88024F	#8 x 3/4 (Flat Hd.)	25	
CDF88032BU	#8 x 1 (Button Hd.)	25	
CDF88032F	#8 x 1 (Flat Hd.)	25	
CDF88040BU	#8 x 1 1/4 (Button Hd.)	20	
CDF88040F	#8 x 1 1/4 (Flat Hd.)	20	
CDF88048BU	#8 x 1 1/2 (Button Hd.)	20	

(continued...)

## PIN TORX SECURITY TAPPING SCREW (cont.)

TAMPERPROO, 18-8 STAINLESS STEEL

Line: 190-08



PART NUMBER	SIZE	QTY/BX	LIST PRICE
CDF03016BU	10 x 1/2 (Button Hd.)	25	
CDF03024BU	10 x 3/4 (Button Hd.)	25	
CDF03024F	10 x 3/4 (Flat Hd.)	25	
CDF03032BU	10 x 1 (Button Hd.)	25	
CDF03032F	10 x 1 (Flat Hd.)	25	
CDF03040BU	10 x 1 1/4 (Button Hd.)	20	
CDF03040F	10 x 1 1/4 (Flat Hd.)	20	
CDF03048BU	10 x 1 1/2 (Button Hd.)	20	
CDF03048F	10 x 1 1/2 (Flat Hd.)	20	

## TORX DRIVE FLAT MACHINE SCREW

ZINC PLATED

Line: 190-15

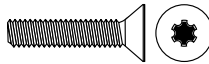

PART NUMBER	SIZE	QTY/BX	LIST PRICE
CFG44020	#4-40 x 5/8 (T8 Key)	100	
CFG66012	#6-32 x 3/8 (T10 Key)	100	
CFG66040	#6-32 x 1 1/4 (T10 Key)	50	
CFG66048	#6-32 x 1 1/2 (T10 Key)	50	
CFG66064	#6-32 x 2 (T10 Key)	50	
CFG88040	#8-32 x 1 1/4 (T15 Key)	50	
CFG88048	#8-32 x 1 1/2 (T15 Key)	50	
CFG03040	#10-24 x 1 1/4 (T20 Key)	50	
CFG03048	#10-24 x 1 1/2 (T20 Key)	50	
CFG03064	#10-24 x 2 (T20 Key)	50	
CFG03080	#10-24 x 2 1/2 (T20 Key)	50	
CFG04048	1/4-20 x 1 1/2 (T27 Key)	25	
CFG04064	1/4-20 x 2 (T27 Key)	25	
CFG04080	1/4-20 x 2 1/2 (T27 Key)	10	
CFG04096	1/4-20 x 3 (T27 Key)	10	

## SLOTTED PAN MACHINE SCREW

W/ EXTERNAL TOOTH LOCKWASHER, ZINC PLATED

Line: 190-20

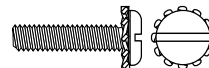

PART NUMBER	SIZE	QTY/BX	LIST PRICE
DEU44008	#4-40 x 1/4	100	
DEU44016	#4-40 x 1/2	100	
DEU88014	#8-32 x 7/16	100	
DEU03016	#10-24 x 1/2	100	
DEU503016	#10-32 x 1/2	100	
DEU503020	#10-32 x 5/8	100	
DEU04024	1/4-20 x 3/4	100	

## SLOTTED PAN MACHINE SCREW

W/ INTERNAL TOOTH LOCKWASHER, ZINC PLATED

Line: 190-21

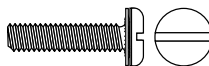

PART NUMBER	SIZE	QTY/BX	LIST PRICE
DGU66020	#6-32 x 5/8	100	
DGUS03008	#10-32 x 1/4	100	

## PHILLIPS PAN MACHINE SCREW

W/ EXTERNAL TOOTH LOCKWASHER, ZINC PLATED

Line: 190-22

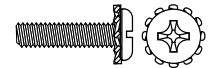

PART NUMBER	SIZE	QTY/BX	LIST PRICE
DBU44006	#4-40 x 3/16	100	
DBU44008	#4-40 x 1/4	100	
DBU44010	#4-40 x 5/16	100	
DBU44012	#4-40 x 3/8	100	
DBU44014	#4-40 x 7/16	100	
DBU44016	#4-40 x 1/2	100	
DBU44020	#4-40 x 5/8	100	
DBU44024	#4-40 x 3/4	100	
DBU66006	#6-32 x 3/16	100	
DBU66008	#6-32 x 1/4	100	
DBU66010	#6-32 x 5/16	100	
DBU66012	#6-32 x 3/8	100	
DBU66014	#6-32 x 7/16	100	
DBU66016	#6-32 x 1/2	100	
DBU66020	#6-32 x 5/8	100	
DBU66024	#6-32 x 3/4	100	
DBU66028	#6-32 x 7/8	100	
DBU66032	#6-32 x 1	100	
DBU66040	#6-32 x 1 1/4	100	
DBU88006	#8-32 x 3/16	100	
DBU88008	#8-32 x 1/4	100	
DBU88010	#8-32 x 5/16	100	
DBU88012	#8-32 x 3/8	100	
DBU88014	#8-32 x 7/16	100	
DBU88016	#8-32 x 1/2	100	
DBU88020	#8-32 x 5/8	100	
DBU88024	#8-32 x 3/4	100	
DBU88028	#8-32 x 7/8	100	
DBU88032	#8-32 x 1	100	
DBU88040	#8-32 x 1 1/4	100	
DBU88048	#8-32 x 1 1/2	100	
DBU03008	#10-24 x 1/4	100	
DBU03010	#10-24 x 5/16	100	
DBU03012	#10-24 x 3/8	100	
DBU03014	#10-24 x 7/16	100	
DBU03016	#10-24 x 1/2	100	
DBU03020	#10-24 x 5/8	100	
DBU03024	#10-24 x 3/4	100	
DBU03028	#10-24 x 7/8	100	
DBU03032	#10-24 x 1	100	
DBUS03008	#10-32 x 1/4	100	
DBUS03010	#10-32 x 5/16	100	
DBUS03012	#10-32 x 3/8	100	
DBUS03014	#10-32 x 7/16	100	

(continued...)

### PHILLIPS PAN MACHINE SCREW (cont.)

W/ EXTERNAL TOOTH LOCKWASHER, ZINC PLATED

Line: 190-22

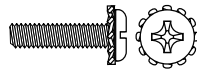

PART NUMBER	SIZE	QTY/BX	LIST PRICE
DBUS03016	#10-32 x 1/2	100	
DBUS03020	#10-32 x 5/8	100	
DBUS03024	#10-32 x 3/4	100	
DBUS03028	#10-32 x 7/8	100	
DBUS03032	#10-32 x 1	100	
DBUS03040	#10-32 x 1 1/4	100	
DBU04012	1/4-20 x 3/8	100	
DBU04016	1/4-20 x 1/2	100	
DBU04020	1/4-20 x 5/8	100	
DBU04024	1/4-20 x 3/4	100	
DBU04032	1/4-20 x 1	100	
DBU04040	1/4-20 x 1 1/4	100	

### PHILLIPS PAN MACHINE SCREW

W/ INTERNAL TOOTH LOCKWASHER, ZINC PLATED

Line: 190-23

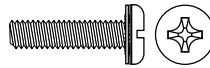

PART NUMBER	SIZE	QTY/BX	LIST PRICE
DCU22012	#2-56 x 3/8	100	
DCU44006	#4-40 x 3/16	100	
DCU66006	#6-32 x 3/16	100	
DCU66008LW	#6-32 x 1/4 (Split L/W)	100	
DCU66010	#6-32 x 5/16	100	
DCU66020	#6-32 x 5/8	100	
DCU88014	#8-32 x 7/16	100	

### HEX HEAD MACHINE SCREW

W/ EXTERNAL TOOTH LOCKWASHER, ZINC PLATED

Line: 190-24

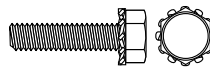

PART NUMBER	SIZE	QTY/BX	LIST PRICE
DHU66008	#6-32 x 1/4	100	
DHU66012	#6-32 x 3/8	100	
DHU66016	#6-32 x 1/2	100	
DHU66020	#6-32 x 5/8	100	
DHU66024	#6-32 x 3/4	100	
DHU88012	#8-32 x 3/8	100	
DHU88016	#8-32 x 1/2	100	
DHU88020	#8-32 x 5/8	100	
DHU88024	#8-32 x 3/4	100	
DHU03012	#10-24 x 3/8	100	
DHU03016	#10-24 x 1/2	100	
DHU03020	#10-24 x 5/8	100	
DHU03024	#10-24 x 3/4	100	
DHUS03008	#10-32 x 1/4	100	
DHUS03010	#10-32 x 5/16	100	
DHUS03012	#10-32 x 3/8	100	
DHUS03016	#10-32 x 1/2	100	

(continued...)

### HEX HEAD MACHINE SCREW (cont.)

W/ EXTERNAL TOOTH LOCKWASHER, ZINC PLATED

Line: 190-24

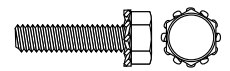

PART NUMBER	SIZE	QTY/BX	LIST PRICE
DHUS03020	#10-32 x 5/8	100	
DHUS03024	#10-32 x 3/4	100	
DHU04012	1/4-20 x 3/8	100	
DHU04016	1/4-20 x 1/2	100	
DHU04020	1/4-20 x 5/8	100	
DHU04024	1/4-20 x 3/4	100	
DHU04032	1/4-20 x 1	100	
DHU04040	1/4-20 x 1 1/4	100	
DHU04048	1/4-20 x 1 1/2	100	

### (TYPE F) SLOTTED FLAT MACHINE SCREW

THREAD CUTTING, ZINC PLATED

Line: 192-00

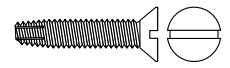

PART NUMBER	SIZE	QTY/BX	LIST PRICE
EPA44008	#4-40 x 1/4	100	
EPA44012	#4-40 x 3/8	100	
EPA66008	#6-32 x 1/4	100	
EPA66012	#6-32 x 3/8	100	
EPA66016	#6-32 x 1/2	100	
EPA66028	#6-32 x 7/8	100	
EPA88008	#8-32 x 1/4	100	
EPA88012	#8-32 x 3/8	100	
EPA88016	#8-32 x 1/2	100	
EPA88020	#8-32 x 5/8	100	
EPA88032	#8-32 x 1	100	
EPA88040	#8-32 x 1 1/4	100	
EPA88048	#8-32 x 1 1/2	100	
EPA03016	#10-24 x 1/2	100	
EPA03020	#10-24 x 5/8	100	
EPA03024	#10-24 x 3/4	100	
EPA03032	#10-24 x 1	100	

### (TYPE F) SLOTTED PAN MACHINE SCREW

THREAD CUTTING, ZINC PLATED

Line: 193-00

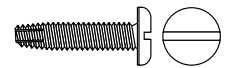

PART NUMBER	SIZE	QTY/BX	LIST PRICE
ERA22004X	#2-56 x 1/8	100	
ERA22006	#2-56 x 3/16	100	
ERA22008	#2-56 x 1/4	100	
ERA44008	#4-40 x 1/4	100	
ERA44010	#4-40 x 5/16	100	
ERA44012	#4-40 x 3/8	100	
ERA44016	#4-40 x 1/2	100	
ERA44020	#4-40 x 5/8	100	
ERA44024	#4-40 x 3/4	100	
ERA44032	#4-40 x 1	100	

(continued...)

**(TYPE F) SLOTTED PAN MACHINE SCREW (cont.)**

THREAD CUTTING, ZINC PLATED

Line: 193-00

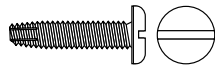

PART NUMBER	SIZE	QTY/BX	LIST PRICE
ERA66008	#6-32 x 1/4	100	
ERA66010	#6-32 x 5/16	100	
ERA66012	#6-32 x 3/8	100	
ERA66016	#6-32 x 1/2	100	
ERA66020	#6-32 x 5/8	100	
ERA66024	#6-32 x 3/4	100	
ERA66032	#6-32 x 1	100	
ERA88008	#8-32 x 1/4	100	
ERA88010	#8-32 x 5/16	100	
ERA88012	#8-32 x 3/8	100	
ERA88016	#8-32 x 1/2	100	
ERA88020	#8-32 x 5/8	100	
ERA88024	#8-32 x 3/4	100	
ERA88028X	#8-32 x 7/8	100	
ERA88032	#8-32 x 1	100	
ERA88040	#8-32 x 1 1/4	100	
ERA88048	#8-32 x 1 1/2	100	
ERA88064	#8-32 x 2	100	
ERA03012	#10-24 x 3/8	100	
ERA03016	#10-24 x 1/2	100	
ERA03020	#10-24 x 5/8	100	
ERA03024	#10-24 x 3/4	100	
ERA03032	#10-24 x 1	100	
ERA03040	#10-24 x 1 1/4	100	
ERA03048	#10-24 x 1 1/2	100	
ERA03064	#10-24 x 2	100	
ERAS03008	#10-32 x 1/4	100	
ERAS03010	#10-32 x 5/16	100	
ERAS03012	#10-32 x 3/8	100	
ERAS03016	#10-32 x 1/2	100	
ERAS03020	#10-32 x 5/8	100	
ERAS03024	#10-32 x 3/4	100	
ERAS03032	#10-32 x 1	100	
ERAS03040	#10-32 x 1 1/4	100	
ERAS03048	#10-32 x 1 1/2	100	
ERAS03064	#10-32 x 2	100	
ERA21016	#12-24 x 1/2	50	
ERA21024	#12-24 x 3/4	50	
ERA04012	1/4-20 x 3/8	100	
ERA04016	1/4-20 x 1/2	100	
ERA04020	1/4-20 x 5/8	100	
ERA04024	1/4-20 x 3/4	100	
ERA04032	1/4-20 x 1	100	
ERA04040	1/4-20 x 1 1/4	100	

(continued...)

**(TYPE F) SLOTTED PAN MACHINE SCREW (cont.)**

THREAD CUTTING, ZINC PLATED

Line: 193-00

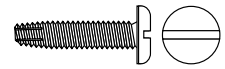

PART NUMBER	SIZE	QTY/BX	LIST PRICE
ERA04048	1/4-20 x 1 1/2	100	
ERA04064	1/4-20 x 2	100	

**(TYPE F) SLOTTED FLAT FLOORBOARD SCREW**

THREAD CUTTING, ZINC PLATED

Line: 194-00

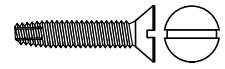

PART NUMBER	SIZE	QTY/BX	LIST PRICE
ESA04040	1/4-20 x 1 1/4	100	
ESA04048	1/4-20 x 1 1/2	100	
ESA04056	1/4-20 x 1 3/4	100	
ESA04064	1/4-20 x 2	100	
ESA04080	1/4-20 x 2 1/2	100	
ESA04096	1/4-20 x 3	100	
ESA04112	1/4-20 x 3 1/2	50	
ESA04128	1/4-20 x 4	50	
ESA05064	5/16-18 x 2	100	
ESA05080	5/16-18 x 2 1/2	50	

**(TYPE F) HEX WASH HEAD MACHINE SCREW**

THREAD CUTTING, ZINC PLATED

Line: 196-00

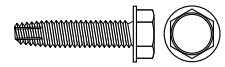

PART NUMBER	SIZE	QTY/BX	LIST PRICE
ETA66008	#6-32 x 1/4	100	
ETA66012	#6-32 x 3/8	100	
ETA66016	#6-32 x 1/2	100	
ETA66020	#6-32 x 5/8	100	
ETA66024	#6-32 x 3/4	100	
ETA66032	#6-32 x 1	100	
ETA88008	#8-32 x 1/4	100	
ETA88010X	#8-32 x 5/16	100	
ETA88012	#8-32 x 3/8	100	
ETA88016	#8-32 x 1/2	100	
ETA88020	#8-32 x 5/8	100	
ETA88024	#8-32 x 3/4	100	
ETA88032	#8-32 x 1	100	
ETA88040	#8-32 x 1 1/4	100	
ETA88048	#8-32 x 1 1/2	100	
ETA88064	#8-32 x 2	100	
ETA03012	#10-24 x 3/8	100	
ETA03016	#10-24 x 1/2	100	
ETA03020	#10-24 x 5/8	100	
ETA03024	#10-24 x 3/4	100	
ETA03032	#10-24 x 1	100	
ETA03040	#10-24 x 1 1/4	100	
ETA03048	#10-24 x 1 1/2	100	
ETAS03012	#10-32 x 3/8	100	

(continued...)



**(TYPE F) HEX WASH HEAD MACHINE SCREW (cont.)**

THREAD CUTTING, ZINC PLATED

Line: 196-00

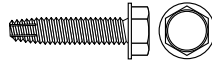

PART NUMBER	SIZE	QTY/BX	LIST PRICE
ETAS03016	#10-32 x 1/2	100	
ETAS03020	#10-32 x 5/8	100	
ETAS03024	#10-32 x 3/4	100	
ETAS03032	#10-32 x 1	100	
ETAS03048	#10-32 x 1 1/2	100	
ETA21016	#12-24 x 1/2	100	
ETA21020	#12-24 x 5/8	100	
ETA21024	#12-24 x 3/4	100	
ETA21032	#12-24 x 1	100	
ETA04012	1/4-20 x 3/8	100	
ETA04016	1/4-20 x 1/2	100	
ETA04020	1/4-20 x 5/8	100	
ETA04024	1/4-20 x 3/4	100	
ETA04032	1/4-20 x 1	100	
ETA04040	1/4-20 x 1 1/4	100	
ETA04048	1/4-20 x 1 1/2	100	
ETA04064	1/4-20 x 2	100	
ETA05016	5/16-18 x 1/2	100	
ETA05020	5/16-18 x 5/8	100	
ETA05024	5/16-18 x 3/4	100	
ETA05032	5/16-18 x 1	100	
ETA05040	5/16-18 x 1 1/4	100	
ETA05048	5/16-18 x 1 1/2	100	
ETA05064	5/16-18 x 2	100	
ETA06016	3/8-16 x 1/2	100	
ETA06020	3/8-16 x 5/8	100	
ETA06024	3/8-16 x 3/4	50	
ETA06032	3/8-16 x 1	50	
ETA06040	3/8-16 x 1 1/4	50	
ETA06048	3/8-16 x 1 1/2	50	
ETA06064	3/8-16 x 2	50	

**(TYPE F) SLOT HEX WASH MACHINE SCREW**

THREAD CUTTING, ZINC PLATED

Line: 197-00

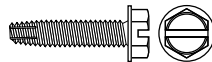

PART NUMBER	SIZE	QTY/BX	LIST PRICE
EYD66008	#6-32 x 1/4	100	
EYD66010	#6-32 x 5/16	100	
EYD66012	#6-32 x 3/8	100	
EYD66016	#6-32 x 1/2	100	
EYD66020	#6-32 x 5/8	100	
EYD66024	#6-32 x 3/4	100	
EYD66032	#6-32 x 1	100	
EYD88008	#8-32 x 1/4	100	
EYD88010	#8-32 x 5/16	100	

(continued...)

**(TYPE F) SLOT HEX WASH MACHINE SCREW (cont.)**

THREAD CUTTING, ZINC PLATED

Line: 197-00

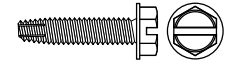

PART NUMBER	SIZE	QTY/BX	LIST PRICE
EYD88012	#8-32 x 3/8	100	
EYD88016	#8-32 x 1/2	100	
EYD88020	#8-32 x 5/8	100	
EYD88024	#8-32 x 3/4	100	
EYD88032	#8-32 x 1	100	
EYD88040	#8-32 x 1 1/4	100	
EYD88048	#8-32 x 1 1/2	100	
EYD88064	#8-32 x 2	100	
EYD03008	#10-24 x 1/4	100	
EYD03012	#10-24 x 3/8	100	
EYD03016	#10-24 x 1/2	100	
EYD03020	#10-24 x 5/8	100	
EYD03024	#10-24 x 3/4	100	
EYD03032	#10-24 x 1	100	
EYD03040	#10-24 x 1 1/4	100	
EYD03048	#10-24 x 1 1/2	100	
EYD03064	#10-24 x 2	100	
EYD03008	#10-32 x 1/4	100	
EYD03012	#10-32 x 3/8	100	
EYD03016	#10-32 x 1/2	100	
EYD03020	#10-32 x 5/8	100	
EYD03024	#10-32 x 3/4	100	
EYD03032	#10-32 x 1	100	
EYD03040	#10-32 x 1 1/4	100	
EYD03048	#10-32 x 1 1/2	100	
EYD03064	#10-32 x 2	100	
EYD04012	1/4-20 x 3/8	100	
EYD04016	1/4-20 x 1/2	100	
EYD04020	1/4-20 x 5/8	100	
EYD04024	1/4-20 x 3/4	100	
EYD04032	1/4-20 x 1	100	
EYD04040	1/4-20 x 1 1/4	100	
EYD04048	1/4-20 x 1 1/2	100	
EYD04056	1/4-20 x 1 3/4	100	
EYD04064	1/4-20 x 2	100	
EYD05016	5/16-18 x 1/2	100	
EYD05020	5/16-18 x 5/8	100	
EYD05024	5/16-18 x 3/4	100	
EYD05032	5/16-18 x 1	50	
EYD05040	5/16-18 x 1 1/4	100	
EYD05048	5/16-18 x 1 1/2	100	
EYD05056	5/16-18 x 1 3/4	100	
EYD05064	5/16-18 x 2	100	
EYD06024	3/8-16 x 3/4	50	

(continued...)

**(TYPE F) SLOT HEX WASH MACHINE SCREW (cont.)**

THREAD CUTTING, ZINC PLATED

Line: 197-00

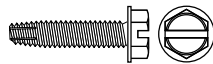

PART NUMBER	SIZE	QTY/BX	LIST PRICE
EYD06032	3/8-16 x 1	50	
EYD06040	3/8-16 x 1 1/4	50	
EYD06048	3/8-16 x 1 1/2	50	
EYD06064	3/8-16 x 2	100	

**(TYPE F) PHILLIPS ROUND MACHINE SCREW**

THREAD CUTTING, ZINC PLATED

Line: 201-00

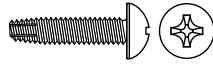

PART NUMBER	SIZE	QTY/BX	LIST PRICE
EXA66008X	#6-32 x 1/4	100	
EXA66012	#6-32 x 3/8	100	
EXA66016	#6-32 x 1/2	100	
EXA66024	#6-32 x 3/4	100	
EXA88012	#8-32 x 3/8	100	
EXA03016	#10-24 x 1/2	100	
EXA03020	#10-24 x 5/8	100	
EXAS03012	#10-32 x 3/8	100	
EXAS03016	#10-32 x 1/2	100	
EXA04016	1/4-20 x 1/2	100	
EXA04024	1/4-20 x 3/4	100	

**(TYPE F) PHILLIPS FLAT MACHINE SCREW**

THREAD CUTTING, ZINC PLATED

Line: 202-00

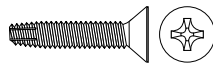

PART NUMBER	SIZE	QTY/BX	LIST PRICE
EYA44008	#4-40 x 1/4	100	
EYA44010	#4-40 x 5/16	100	
EYA44012	#4-40 x 3/8	100	
EYA44016	#4-40 x 1/2	100	
EYA44020	#4-40 x 5/8	100	
EYA44024	#4-40 x 3/4	100	
EYA66008	#6-32 x 1/4	100	
EYA66012	#6-32 x 3/8	100	
EYA66016	#6-32 x 1/2	100	
EYA66020	#6-32 x 5/8	100	
EYA66024	#6-32 x 3/4	100	
EYA88008	#8-32 x 1/4	100	
EYA88012	#8-32 x 3/8	100	
EYA88016	#8-32 x 1/2	100	
EYA88020	#8-32 x 5/8	100	
EYA88024	#8-32 x 3/4	100	
EYA88032	#8-32 x 1	100	
EYA03012	#10-24 x 3/8	100	
EYA03016	#10-24 x 1/2	100	
EYA03020	#10-24 x 5/8	100	
EYA03024	#10-24 x 3/4	100	

(continued...)

**(TYPE F) PHILLIPS FLAT MACHINE SCREW (cont.)**

THREAD CUTTING, ZINC PLATED

Line: 202-00

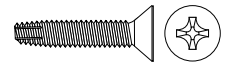

PART NUMBER	SIZE	QTY/BX	LIST PRICE
EYA03032	#10-24 x 1	100	
EYA03040	#10-24 x 1 1/4	100	
EYA03048	#10-24 x 1 1/2	100	
EYAS03016	#10-32 x 1/2	100	
EYAS03020	#10-32 x 5/8	100	
EYAS03024	#10-32 x 3/4	100	
EYAS03032	#10-32 x 1	100	
EYAS03040	#10-32 x 1 1/4	100	
EYAS03048	#10-32 x 1 1/2	100	
EYA04016	1/4-20 x 1/2 (Undercut)	100	
EYA04024X	1/4-20 x 3/4	100	
EYA04032	1/4-20 x 1	100	
EYA04040	1/4-20 x 1 1/4	100	
EYA04048	1/4-20 x 1 1/2	100	
EYA04064	1/4-20 x 2	100	
EYA04080	1/4-20 x 2 1/2	100	
EYA04096	1/4-20 x 3	100	

**(TYPE F) PHILLIPS PAN MACHINE SCREW**

THREAD CUTTING, ZINC PLATED

Line: 203-00

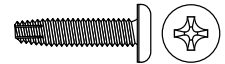

PART NUMBER	SIZE	QTY/BX	LIST PRICE
EZA44008	#4-40 x 1/4	100	
EZA44010	#4-40 x 5/16	100	
EZA44012	#4-40 x 3/8	100	
EZA44016	#4-40 x 1/2	100	
EZA44020	#4-40 x 5/8	100	
EZA44024	#4-40 x 3/4	100	
EZA66008	#6-32 x 1/4	100	
EZA66010	#6-32 x 5/16	100	
EZA66012	#6-32 x 3/8	100	
EZA66016	#6-32 x 1/2	100	
EZA66020	#6-32 x 5/8	100	
EZA66024	#6-32 x 3/4	100	
EZA66032	#6-32 x 1	100	
EZA88008	#8-32 x 1/4	100	
EZA88010	#8-32 x 5/16	100	
EZA88012	#8-32 x 3/8	100	
EZA88016	#8-32 x 1/2	100	
EZA88020	#8-32 x 5/8	100	
EZA88024	#8-32 x 3/4	100	
EZA88032	#8-32 x 1	100	
EZA88040	#8-32 x 1 1/4	100	
EZA88048	#8-32 x 1 1/2	100	
EZA03010	#10-24 x 5/16	100	

(continued...)

**(TYPE F) PHILLIPS PAN MACHINE SCREW (cont.)**

THREAD CUTTING, ZINC PLATED

Line: 203-00

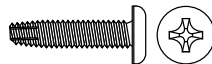

PART NUMBER	SIZE	QTY/BX	LIST PRICE
EZA03012	#10-24 x 3/8	100	
EZA03016	#10-24 x 1/2	100	
EZA03020	#10-24 x 5/8	100	
EZA03024	#10-24 x 3/4	100	
EZA03032	#10-24 x 1	100	
EZA03040	#10-24 x 1 1/4	100	
EZA03048	#10-24 x 1 1/2	100	
EZAS03012	#10-32 x 3/8	100	
EZAS03016	#10-32 x 1/2	100	
EZAS03020	#10-32 x 5/8	100	
EZAS03024	#10-32 x 3/4	100	
EZAS03032	#10-32 x 1	100	
EZAS03040	#10-32 x 1 1/4	100	
EZAS03048	#10-32 x 1 1/2	100	
EZA04012	1/4-20 x 3/8	100	
EZA04016	1/4-20 x 1/2	100	
EZA04020	1/4-20 x 5/8	100	
EZA04024	1/4-20 x 3/4	100	
EZA04032	1/4-20 x 1	100	
EZA04040	1/4-20 x 1 1/4	100	
EZA04048	1/4-20 x 1 1/2	100	
EZA04064	1/4-20 x 2	100	
EZA05024	5/16-18 x 3/4	100	

**(TYPE F) PHILLIPS FLAT FLOORBOARD SCREW**

THREAD CUTTING, ZINC PLATED

Line: 204-00

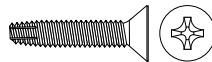

PART NUMBER	SIZE	QTY/BX	LIST PRICE
FAA04032	1/4-20 x 1	100	
FAA04040	1/4-20 x 1 1/4	100	
FAA04048	1/4-20 x 1 1/2	100	
FAA04056	1/4-20 x 1 3/4	100	
FAA04064	1/4-20 x 2	100	
FAA04072	1/4-20 x 2 1/4	100	
FAA04080	1/4-20 x 2 1/2	100	
FAA04096	1/4-20 x 3	100	
FAA04128	1/4-20 x 4	50	
FAA04160X	1/4-20 x 5	50	
FAA05064	5/16-18 x 2	100	
FAA05080	5/16-18 x 2 1/2	100	
FAA05096	5/16-18 x 3	50	

**(TYPE F) PHILLIPS FLAT MACHINE SCREW**

THREAD CUTTING, ZINC PLATED

Line: 205-00

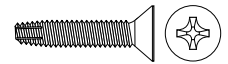

PART NUMBER	SIZE	QTY/BX	LIST PRICE
FAA04016	1/4-20 x 1/2	100	
FAA04020	1/4-20 x 5/8	100	
FAA04024	1/4-20 x 3/4	100	

**(TYPE F) TORX DRIVE FLOORBOARD SCREW**

THREAD CUTTING, BLACK PHOSPHATE

Line: 206-00

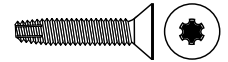

PART NUMBER	SIZE	QTY/BX	LIST PRICE
HFD04040	1/4-20 x 1 1/4	100	
HFD04048	1/4-20 x 1 1/2	100	
HFD04056	1/4-20 x 1 3/4	100	
HFD04064	1/4-20 x 2	100	
HFD04072	1/4-20 x 2 1/4	100	
HFD04080	1/4-20 x 2 1/2	100	
HFD04096	1/4-20 x 3	100	
HFD04112	1/4-20 x 3 1/2	100	
HFD04128	1/4-20 x 4	100	
HFD05056	5/16-18 x 1 3/4	100	
HFD05064	5/16-18 x 2	100	
HFD05072	5/16-18 x 2 1/4	100	
HFD05080	5/16-18 x 2 1/2	50	
HFD05096	5/16-18 x 3	50	

**PHIL PAN THREAD-ROLLING SCREW**

ZINC/WAX

Line: 207-02



PART NUMBER	SIZE	QTY/BX	LIST PRICE
CFE44008	#4-40 x 1/4	100	
CFE44010	#4-40 x 5/16	100	
CFE44012	#4-40 x 3/8	100	
CFE44016	#4-40 x 1/2	100	
CFE66008	#6-32 x 1/4	100	
CFE66010	#6-32 x 5/16	100	
CFE66012	#6-32 x 3/8	100	
CFE66016	#6-32 x 1/2	100	
CFE66020	#6-32 x 5/8	100	
CFE66024	#6-32 x 3/4	100	
CFE88010	#8-32 x 5/16	100	
CFE88012	#8-32 x 3/8	100	
CFE88016	#8-32 x 1/2	100	
CFE88020	#8-32 x 5/8	100	
CFE88024	#8-32 x 3/4	100	
CFE03012	#10-24 x 3/8	100	
CFE03016	#10-24 x 1/2	100	
CFE03020	#10-24 x 5/8	100	
CFE03024	#10-24 x 3/4	100	

(continued...)

**PHIL PAN THREAD-ROLLING SCREW (cont.)**

ZINC/WAX

Line: 207-02



PART NUMBER	SIZE	QTY/BX	LIST PRICE
CFES03012	#10-32 x 3/8	100	
CFES03016	#10-32 x 1/2	100	
CFES03020	#10-32 x 5/8	100	
CFES03024	#10-32 x 3/4	100	
CFE21020	#12-24 x 5/8	100	

**HEX WASH HD THREAD-ROLLING SCREW**

ZINC/WAX

Line: 207-03



PART NUMBER	SIZE	QTY/BX	LIST PRICE
CFF66008	#6-32 x 1/4	100	
CFF66010	#6-32 x 5/16	100	
CFF66012	#6-32 x 3/8	100	
CFF66016	#6-32 x 1/2	100	
CFF66020	#6-32 x 5/8	100	
CFF66024	#6-32 x 3/4	100	
CFF88010	#8-32 x 5/16	100	
CFF88012	#8-32 x 3/8	100	
CFF88016	#8-32 x 1/2	100	
CFF88020	#8-32 x 5/8	100	
CFF88024	#8-32 x 3/4	100	
CFF03012	#10-24 x 3/8	100	
CFF03016	#10-24 x 1/2	100	
CFF03020	#10-24 x 5/8	100	
CFF03024	#10-24 x 3/4	100	
CFFS03012	#10-32 x 3/8	100	
CFFS03016	#10-32 x 1/2	100	
CFFS03020	#10-32 x 5/8	100	
CFFS03024	#10-32 x 3/4	100	
CFF04012	1/4-20 x 3/8	100	
CFF04016	1/4-20 x 1/2	100	
CFF04020	1/4-20 x 5/8	100	
CFF04024	1/4-20 x 3/4	100	
CFF04032	1/4-20 x 1	100	
CFF05016	5/16-18 x 1/2	100	
CFF05024	5/16-18 x 3/4	100	
CFF05032	5/16-18 x 1	100	
CFF05040	5/16-18 x 1 1/4	100	

**(TYPE F) HEX HEAD MACHINE SCREW**

W/ EXTERNAL TOOTH LOCKWASHER, ZINC PLATED

Line: 208-00

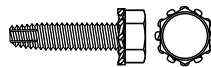

PART NUMBER	SIZE	QTY/BX	LIST PRICE
FCA88016	#8-32 x 1/2	100	
FCA03016	#10-24 x 1/2	100	
FCA03024	#10-24 x 3/4	100	

**(TYPE F) HEX HEAD MACHINE SCREW (cont.)**

W/ EXTERNAL TOOTH LOCKWASHER, ZINC PLATED

Line: 208-00

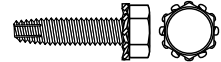

PART NUMBER	SIZE	QTY/BX	LIST PRICE
FCAS03016	#10-32 x 1/2	100	
FCAS03032	#10-32 x 1	100	
FCA04016	1/4-20 x 1/2	100	
FCA04024	1/4-20 x 3/4	100	
FCA04032	1/4-20 x 1	100	
FCA05016	5/16-18 x 1/2	100	
FCA05024	5/16-18 x 3/4	100	
FCA05032	5/16-18 x 1	100	

**(TYPE F) PHILLIPS PAN MACHINE SCREW**

W/ EXTERNAL TOOTH LOCKWASHER, ZINC PLATED

Line: 212-00

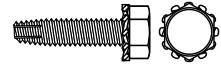

PART NUMBER	SIZE	QTY/BX	LIST PRICE
FGA66012	#6-32 x 3/8	100	
FGA66016	#6-32 x 1/2	100	
FGA03016	#10-24 x 1/2	100	
FGA04024	1/4-20 x 3/4	100	

**SLOTTED PAN SHEET METAL SCREW**

ZINC PLATED

Line: 214-00

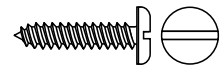

PART NUMBER	SIZE	QTY/BX	LIST PRICE
FJA22006	#2 x 3/16	100	
FJA22008	#2 x 1/4	100	
FJA22012	#2 x 3/8	100	
FJA22016	#2 x 1/2	100	
FJA22020	#2 x 5/8	100	
FJA22024X	#2 x 3/4	100	
FJA44008	#4 x 1/4	100	
FJA44012	#4 x 3/8	100	
FJA44016	#4 x 1/2	100	
FJA44020	#4 x 5/8	100	
FJA44024	#4 x 3/4	100	
FJA44028	#4 x 7/8	100	
FJA44032	#4 x 1	100	
FJA44040	#4 x 1 1/4	100	
FJA66008	#6 x 1/4	100	
FJA66012	#6 x 3/8	100	
FJA66016	#6 x 1/2	100	
FJA66020	#6 x 5/8	100	
FJA66024	#6 x 3/4	100	
FJA66028	#6 x 7/8	100	
FJA66032	#6 x 1	100	
FJA66040	#6 x 1 1/4	100	
FJA66048	#6 x 1 1/2	100	
FJA66056	#6 x 1 3/4	100	

(continued...)

## SLOTTED PAN SHEET METAL SCREW (cont.)

ZINC PLATED

Line: 214-00

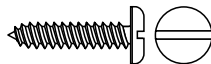

PART NUMBER	SIZE	QTY/BX	LIST PRICE
FJA66064	#6 x 2	100	
FJA77008	#7 x 1/4	100	
FJA77012	#7 x 3/8	100	
FJA77016	#7 x 1/2	100	
FJA77020	#7 x 5/8	100	
FJA77024	#7 x 3/4	100	
FJA77028X	#7 x 7/8	100	
FJA77032	#7 x 1	100	
FJA77040	#7 x 1 1/4	100	
FJA77048	#7 x 1 1/2	100	
FJA88008	#8 x 1/4	100	
FJA88012	#8 x 3/8	100	
FJA88016	#8 x 1/2	100	
FJA88020	#8 x 5/8	100	
FJA88024	#8 x 3/4	100	
FJA88028	#8 x 7/8	100	
FJA88032	#8 x 1	100	
FJA88040	#8 x 1 1/4	100	
FJA88048	#8 x 1 1/2	100	
FJA88056	#8 x 1 3/4	100	
FJA88064	#8 x 2	100	
FJA88080	#8 x 2 1/2	50	
FJA88096	#8 x 3	50	
FJA03008	#10 x 1/4	100	
FJA03012	#10 x 3/8	100	
FJA03016	#10 x 1/2	100	
FJA03020	#10 x 5/8	100	
FJA03024	#10 x 3/4	100	
FJA03028	#10 x 7/8	100	
FJA03032	#10 x 1	100	
FJA03040	#10 x 1 1/4	100	
FJA03048	#10 x 1 1/2	100	
FJA03056	#10 x 1 3/4	100	
FJA03064	#10 x 2	100	
FJA03080	#10 x 2 1/2	50	
FJA03096	#10 x 3	50	
FJA21012	#12 x 3/8	100	
FJA21016	#12 x 1/2	100	
FJA21020	#12 x 5/8	100	
FJA21024	#12 x 3/4	100	
FJA21028	#12 x 7/8	100	
FJA21032	#12 x 1	100	
FJA21040	#12 x 1 1/4	100	
FJA21048	#12 x 1 1/2	100	

(continued...)

## SLOTTED PAN SHEET METAL SCREW (cont.)

ZINC PLATED

Line: 214-00

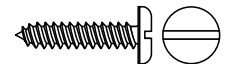

PART NUMBER	SIZE	QTY/BX	LIST PRICE
FJA21056	#12 x 1 3/4	50	
FJA21064	#12 x 2	50	
FJA21080	#12 x 2 1/2	50	
FJA21096	#12 x 3	50	
FJA04016	#14 x 1/2	100	
FJA04020	#14 x 5/8	100	
FJA04024	#14 x 3/4	100	
FJA04028	#14 x 7/8	100	
FJA04032	#14 x 1	100	
FJA04040	#14 x 1 1/4	100	
FJA04048	#14 x 1 1/2	100	
FJA04056	#14 x 1 3/4	50	
FJA04064	#14 x 2	50	
FJA04080	#14 x 2 1/2	50	
FJA04096	#14 x 3	50	
FJA04112	#14 x 3 1/2	50	

## SLOTTED ROUND SHEET METAL SCREW

ZINC PLATED

Line: 215-00

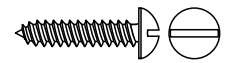

PART NUMBER	SIZE	QTY/BX	LIST PRICE
FKA22008	#2 x 1/4	100	
FKA22012	#2 x 3/8	100	
FKA44008	#4 x 1/4	100	
FKA44012	#4 x 3/8	100	
FKA44016	#4 x 1/2	100	
FKA44020	#4 x 5/8	100	
FKA44024	#4 x 3/4	100	
FKA66008	#6 x 1/4	100	
FKA66012	#6 x 3/8	100	
FKA66016	#6 x 1/2	100	
FKA66020	#6 x 5/8	100	
FKA66024	#6 x 3/4	100	
FKA66028	#6 x 7/8	100	
FKA66032	#6 x 1	100	
FKA66040	#6 x 1 1/4	100	
FKA66048	#6 x 1 1/2	100	
FKA77012	#7 x 3/8	100	
FKA77020	#7 x 5/8	100	
FKA77024	#7 x 3/4	100	
FKA77028	#7 x 7/8	100	
FKA77032	#7 x 1	100	
FKA77040	#7 x 1 1/4	100	
FKA77048	#7 x 1 1/2	100	
FKA88008	#8 x 1/4	100	

(continued...)

## SLOTTED ROUND SHEET METAL SCREW (cont.)

ZINC PLATED

Line: 215-00



PART NUMBER	SIZE	QTY/BX	LIST PRICE
FKA88012	#8 x 3/8	100	
FKA88020	#8 x 5/8	100	
FKA88024	#8 x 3/4	100	
FKA88024YZ	#8 x 3/4 (Type A)	1	
FKA88028	#8 x 7/8	100	
FKA88032	#8 x 1	100	
FKA88040	#8 x 1 1/4	100	
FKA88048	#8 x 1 1/2	100	
FKA88056	#8 x 1 3/4	100	
FKA88064	#8 x 2	100	
FKA88080	#8 x 2 1/2	100	
FKA03012	#10 x 3/8	100	
FKA03016	#10 x 1/2	100	
FKA03020	#10 x 5/8	100	
FKA03028	#10 x 7/8	100	
FKA03048	#10 x 1 1/2	100	
FKA03056	#10 x 1 3/4	100	
FKA21012	#12 x 3/8	100	
FKA21016	#12 x 1/2	100	
FKA21024	#12 x 3/4	100	
FKA21028	#12 x 7/8	100	
FKA21032	#12 x 1	100	
FKA21040	#12 x 1 1/4	100	
FKA21048	#12 x 1 1/2	100	
FKA21056	#12 x 1 3/4	100	
FKA21064	#12 x 2	100	
FKA21080	#12 x 2 1/2	100	
FKA21096	#12 x 3	100	
FKA04016	#14 x 1/2	100	
FKA04020	#14 x 5/8	100	
FKA04028X	#14 x 7/8	100	
FKA04032	#14 x 1	100	
FKA04040	#14 x 1 1/4	100	
FKA04048	#14 x 1 1/2	100	
FKA04056X	#14 x 1 3/4	50	
FKA04064	#14 x 2	50	
FKA04080	#14 x 2 1/2	50	
FKA04096	#14 x 3	50	

## SLOTTED FLAT SHEET METAL SCREW

ZINC PLATED

Line: 216-00

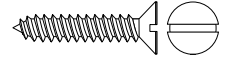

PART NUMBER	SIZE	QTY/BX	LIST PRICE
FLA22012	#2 x 3/8	100	
FLA44008	#4 x 1/4	100	
FLA44012	#4 x 3/8	100	
FLA44016	#4 x 1/2	100	
FLA44020	#4 x 5/8	100	
FLA44024	#4 x 3/4	100	
FLA44028	#4 x 7/8	100	
FLA44032	#4 x 1	100	
FLA66008	#6 x 1/4	100	
FLA66012	#6 x 3/8	100	
FLA66016	#6 x 1/2	100	
FLA66020	#6 x 5/8	100	
FLA66024	#6 x 3/4	100	
FLA66028	#6 x 7/8	100	
FLA66032	#6 x 1	100	
FLA66040	#6 x 1 1/4	100	
FLA66048	#6 x 1 1/2	100	
FLA66056X	#6 x 1 3/4	100	
FLA77012	#7 x 3/8	100	
FLA77016	#7 x 1/2	100	
FLA77020X	#7 x 5/8	100	
FLA77024	#7 x 3/4	100	
FLA77028	#7 x 7/8	100	
FLA77032	#7 x 1	100	
FLA77040	#7 x 1 1/4	100	
FLA88008	#8 x 1/4	100	
FLA88012	#8 x 3/8	100	
FLA88016	#8 x 1/2	100	
FLA88020	#8 x 5/8	100	
FLA88024	#8 x 3/4	100	
FLA88028	#8 x 7/8	100	
FLA88032	#8 x 1	100	
FLA88040	#8 x 1 1/4	100	
FLA88048	#8 x 1 1/2	100	
FLA88056	#8 x 1 3/4	100	
FLA88064	#8 x 2	100	
FLA88080X	#8 x 2 1/2	50	
FLA88096	#8 x 3	50	
FLA03012	#10 x 3/8	100	
FLA03016	#10 x 1/2	100	
FLA03020	#10 x 5/8	100	
FLA03024	#10 x 3/4	100	
FLA03028	#10 x 7/8	100	
FLA03032	#10 x 1	100	

(continued...)

## SLOTTED FLAT SHEET METAL SCREW (cont.)

ZINC PLATED

Line: 216-00

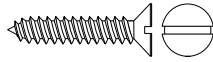

PART NUMBER	SIZE	QTY/BX	LIST PRICE
FLA03040	#10 x 1 1/4	100	
FLA03048	#10 x 1 1/2	100	
FLA03056	#10 x 1 3/4	100	
FLA03064	#10 x 2	100	
FLA03080	#10 x 2 1/2	50	
FLA03096	#10 x 3	50	
FLA21016	#12 x 1/2	100	
FLA21020	#12 x 5/8	100	
FLA21024	#12 x 3/4	100	
FLA21028	#12 x 7/8	100	
FLA21032	#12 x 1	100	
FLA21040	#12 x 1 1/4	100	
FLA21048	#12 x 1 1/2	100	
FLA21056	#12 x 1 3/4	50	
FLA21064	#12 x 2	50	
FLA21080	#12 x 2 1/2	50	
FLA21096	#12 x 3	50	
FLA04016	#14 x 1/2	100	
FLA04020	#14 x 5/8	100	
FLA04024	#14 x 3/4	100	
FLA04028	#14 x 7/8	100	
FLA04032	#14 x 1	100	
FLA04040	#14 x 1 1/4	100	
FLA04048	#14 x 1 1/2	100	
FLA04056X	#14 x 1 3/4	50	
FLA04064	#14 x 2	50	
FLA04096	#14 x 3	50	

## SLOTTED TRUSS SHEET METAL SCREW

ZINC PLATED

Line: 217-00

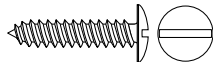

PART NUMBER	SIZE	QTY/BX	LIST PRICE
FMA44008	#4 x 1/4	100	
FMA44012	#4 x 3/8	100	
FMA44016	#4 x 1/2	100	
FMA44020	#4 x 5/8	100	
FMA44024	#4 x 3/4	100	
FMA66008	#6 x 1/4	100	
FMA66012	#6 x 3/8	100	
FMA66016	#6 x 1/2	100	
FMA66020	#6 x 5/8	100	
FMA66024	#6 x 3/4	100	
FMA66028	#6 x 7/8	100	
FMA66032	#6 x 1	100	
FMA66040	#6 x 1 1/4	100	

(continued...)

## SLOTTED TRUSS SHEET METAL SCREW (cont.)

ZINC PLATED

Line: 217-00

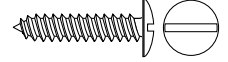

PART NUMBER	SIZE	QTY/BX	LIST PRICE
FMA66048	#6 x 1 1/2	100	
FMA88008	#8 x 1/4	100	
FMA88012	#8 x 3/8	100	
FMA88016	#8 x 1/2	100	
FMA88020	#8 x 5/8	100	
FMA88024	#8 x 3/4	100	
FMA88028	#8 x 7/8	100	
FMA88032	#8 x 1	100	
FMA88040	#8 x 1 1/4	100	
FMA88048	#8 x 1 1/2	100	
FMA03012	#10 x 3/8	100	
FMA03016	#10 x 1/2	100	
FMA03020	#10 x 5/8	100	
FMA03024	#10 x 3/4	100	
FMA03028	#10 x 7/8	100	
FMA03032	#10 x 1	100	
FMA03040	#10 x 1 1/4	100	
FMA03048	#10 x 1 1/2	100	
FMA03056	#10 x 1 3/4	100	
FMA03064	#10 x 2	100	
FMA21016	#12 x 1/2	100	
FMA21020	#12 x 5/8	100	
FMA21024	#12 x 3/4	100	
FMA21048	#12 x 1 1/2	100	
FMA21064	#12 x 2	50	
FMA04016	#14 x 1/2	100	
FMA04020	#14 x 5/8	100	
FMA04024	#14 x 3/4	100	
FMA04028	#14 x 7/8	100	
FMA04032	#14 x 1	100	

## UNSLOTTED HEX HEAD SHEET METAL SCREW

WITHOUT WASHER HEAD, ZINC PLATED

Line: 218-00

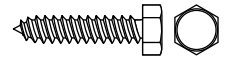

PART NUMBER	SIZE	QTY/BX	LIST PRICE
FNA66024NSNW	#6 x 3/4	100	
FNA66032NSNW	#6 x 1	100	
FNA88012NSNW	#8 x 3/8	100	
FNA88016NSNW	#8 x 1/2	100	
FNA88020NSNW	#8 x 5/8	100	
FNA88024UNSL	#8 x 3/4	100	
FNA88028NSNW	#8 x 7/8	100	
FNA03012NSNW	#10 x 3/8	100	
FNA03016NSNW	#10 x 1/2	100	
FNA03020UNSL	#10 x 5/8	100	

(continued...)

## UNSLOTTED HEX HEAD SHEET METAL SCREW (cont.)

WITHOUT WASHER HEAD, ZINC PLATED

Line: 218-00



PART NUMBER	SIZE	QTY/BX	LIST PRICE
FNA03024NSNW	#10 x 3/4	100	
FNA03024SERR	#10 x 3/4 (Serrated Washer)	6000	
FNA03032NSNW	#10 x 1	100	
FNA03040NSNW	#10 x 1 1/4	100	
FNA03048UNSL	#10 x 1 1/2	100	
FNA03080C	#10 x 2 1/2	100	
FNA03096C	#10 x 3	100	
FNA21008UNSL	#12 x 1/4	100	
FNA21016UNSL	#12 x 1/2	100	
FNA21024UNSL	#12 x 3/4	100	
FNA21032UNSL	#12 x 1	100	
FNA04016UNSL	#14 x 1/2 (3/8 AF)	100	
FNA04020UNSL	#14 x 5/8 (3/8 AF)	100	
FNA04020NSNW	#14 x 5/8 (7/16 AF)	100	
FNA04024UNSL	#14 x 3/4 (3/8 AF)	100	
FNA04024UNSX	#14 x 3/4 (7/16 AF)	100	
FNA04024GRGDR	#14 x 3/4 (7/16 AF, Serr. Wash.)	12000	
FNA04032UNSL	#14 x 1 (3/8 AF)	100	
FNA04032UNSX	#14 x 1 (7/16 AF)	100	
FNA04032GRGDR	#14 x 1 (7/16 AF)	1	
FNA04040NSNW	#14 x 1 1/4 (3/8 AF)	100	
FNA04040UNSL	#14 x 1 1/4 (7/16 AF)	100	
FNA04048UNSL	#14 x 1 1/2 (7/16 AF)	100	
FNA04064UNSL	#14 x 2 (7/16 AF)	50	
FNA04064NSNW	#14 x 2 (7/16 AF)	100	
FNA04080UNSL	#14 x 2 1/2 (7/16 AF)	50	
FNA04096C	#14 x 3	100	
FNA05016	5/16 x 1/2 (1/2 AF)	50	
FNA05024	5/16 x 3/4 (1/2 AF)	50	
FNA05024NSNW	5/16 x 3/4 (1/2 AF)	100	
FNA05032NSNW	5/16 x 1 (1/2 AF)	100	
FNA05032	5/16 x 1 (1/2 AF)	50	
FNA05040	5/16 x 1 1/4 (1/2 AF)	50	
FNA05040NSNW	5/16 x 1 1/4	100	
FNA05048	5/16 x 1 1/2 (1/2 AF)	50	
FNA05048NSNW	5/16 x 1 1/2	100	
FNA05056	5/16 x 1 3/4 (1/2 AF)	50	
FNA05064	5/16 x 2 (1/2 AF)	50	
FNA05064NSNW	5/16 x 2 (1/2 AF)	100	
FNA05080X	5/16 x 2 1/2 (1/2 AF)	25	
FNA05096	5/16 x 3 (1/2 AF)	50	
FNA06024	3/8 x 3/4	50	
FNA06032	3/8 x 1	50	
FNA06032NSNW	3/8 x 1	100	

(continued...)

## UNSLOTTED HEX HEAD SHEET METAL SCREW (cont.)

WITHOUT WASHER HEAD, ZINC PLATED

Line: 218-00



PART NUMBER	SIZE	QTY/BX	LIST PRICE
FNA06040	3/8 x 1 1/4	50	
FNA06040NSNW	3/8 x 1 1/4	100	
FNA06048	3/8 x 1 1/2	25	
FNA06048NSNW	3/8 x 1 1/2	100	
FNA06064	3/8 x 2	25	
FNA06080	3/8 x 2 1/2 (9/16 AF)	25	

## UNSLOTTED HEX HEAD SHEET METAL SCREW

WITH WASHER HEAD, ZINC PLATED

Line: 218-01



PART NUMBER	SIZE	QTY/BX	LIST PRICE
FNA88016NSWH	#8 x 1/2	100	
FNA88024NSWH	#8 x 3/4	100	
FNA88048NSWH	#8 x 1 1/2	100	
FNA03020NSWH	#10 x 5/8	100	
FNA03024NSWH	#10 x 3/4	100	
FNA03032NSWH	#10 x 1	100	
FNA03048NSWH	#10 x 1 1/2	100	
FNA21020NSWH	#12 x 5/8	100	
FNA21032UNWH	#12 x 1	100	
FNA04020ABY	#14 x 5/8 (AB, Zinc Yellow)	1	
FNA04096UNSL	#14 x 3	50	
FNA05048NSWH	5/16 x 1 1/2 (1/2 AF)	50	

## SLOTTED HEX HEAD SHEET METAL SCREW

WITH WASHER HEAD, ZINC PLATED

Line: 219-00

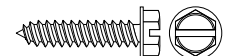

PART NUMBER	SIZE	QTY/BX	LIST PRICE
FNA44008	#4 x 1/4	100	
FNA44012	#4 x 3/8	100	
FNA44016	#4 x 1/2	100	
FNA44020	#4 x 5/8	100	
FNA44024	#4 x 3/4	100	
FNA44032X	#4 x 1	100	
FNA66008	#6 x 1/4	100	
FNA66012	#6 x 3/8	100	
FNA66016	#6 x 1/2	100	
FNA66020	#6 x 5/8	100	
FNA66024	#6 x 3/4	100	
FNA66032	#6 x 1	100	
FNA66040X	#6 x 1 1/4	100	
FNA66048	#6 x 1 1/2	100	
FNA66064	#6 x 2	100	
FNA77016X	#7 x 1/2	100	
FNA77024	#7 x 3/4	100	
FNA77032	#7 x 1	100	

(continued...)



## SLOTTED HEX HEAD SHEET METAL SCREW (cont.)

WITH WASHER HEAD, ZINC PLATED

Line: 219-00

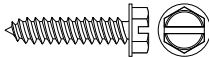

PART NUMBER	SIZE	QTY/BX	LIST PRICE
FNA88008	#8 x 1/4	100	
FNA88012	#8 x 3/8	100	
FNA88016	#8 x 1/2	100	
FNA88020	#8 x 5/8	100	
FNA88024	#8 x 3/4	100	
FNA88028	#8 x 7/8	100	
FNA88032	#8 x 1	100	
FNA88040	#8 x 1 1/4	100	
FNA88048	#8 x 1 1/2	100	
FNA88056	#8 x 1 3/4	100	
FNA88064X	#8 x 2	100	
FNA88080	#8 x 2 1/2	50	
FNA88096	#8 x 3	100	
FNA03012	#10 x 3/8	100	
FNA03016	#10 x 1/2	100	
FNA03020	#10 x 5/8	100	
FNA03024	#10 x 3/4	100	
FNA03028	#10 x 7/8	100	
FNA03032	#10 x 1	100	
FNA03040	#10 x 1 1/4	100	
FNA03048	#10 x 1 1/2	100	
FNA03056	#10 x 1 3/4	100	
FNA03064	#10 x 2	100	
FNA03072	#10 x 2 1/4 (Partial Thread)	50	
FNA03080	#10 x 2 1/2	50	
FNA03096	#10 x 3	50	
FNA03112	#10 x 3 1/2	50	
FNA03128	#10 x 4	50	
FNA21016	#12 x 1/2	100	
FNA21020	#12 x 5/8	100	
FNA21024	#12 x 3/4	100	
FNA21028	#12 x 7/8	100	
FNA21032	#12 x 1	100	
FNA21040	#12 x 1 1/4	100	
FNA21048	#12 x 1 1/2	100	
FNA21056X	#12 x 1 3/4	50	
FNA21064	#12 x 2	50	
FNA21080	#12 x 2 1/2	50	
FNA21096	#12 x 3	50	
FNA04012X	#14 x 3/8	100	
FNA04016	#14 x 1/2 (Type AB)	100	
FNA04020	#14 x 5/8 (Type AB)	100	
FNA04024	#14 x 3/4	100	
FNA04028	#14 x 7/8	50	

(continued...)

## SLOTTED HEX HEAD SHEET METAL SCREW (cont.)

WITH WASHER HEAD, ZINC PLATED

Line: 219-00

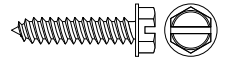

PART NUMBER	SIZE	QTY/BX	LIST PRICE
FNA04032	#14 x 1	100	
FNA04040	#14 x 1 1/4	100	
FNA04048	#14 x 1 1/2	100	
FNA04056	#14 x 1 3/4	50	
FNA04064	#14 x 2	50	
FNA04080	#14 x 2 1/2	50	
FNA04096	#14 x 3	50	
FNA04128	#14 x 4	50	
FNA05016SHWH	5/16 x 1/2	25	
FNA05024SHWH	5/16 x 3/4	25	
FNA05032SHWH	5/16 x 1	25	
FNA05040WHD	5/16 x 1 1/4	100	
FNA05048SHWH	5/16 x 1 1/2 (1/2 AF)	25	
FNA05064SHWH	5/16 x 2 (1/2 AF)	25	
FNA06024SHWH	3/8 x 3/4 (9/16 AF)	25	
FNA06032SHWH	3/8 x 1 (9/16 AF)	25	
FNA06048SHWH	3/8 x 1 1/2 (9/16 AF)	25	
FNA06064SHWH	3/8 x 2 (9/16 AF)	25	

## SLOT HEX WASHER HEAD SHEET METAL SCREW

NEEDLE POINT, ZINC PLATED

Line: 219-01



PART NUMBER	SIZE	QTY/BX	LIST PRICE
FNA66012NP	#6 x 3/8	100	
FNA77016NP	#7 x 1/2	100	
FNA88016NP	#8 x 1/2	100	
FNA88016NPM	#8 x 1/2 (Tub Pack)	1000	
FNA88024NP	#8 x 3/4	100	
FNA88024NPM	#8 x 3/4 (Tub Pack)	1000	
FNA88032NP	#8 x 1	100	
FNA88032NP500	#8 x 1 (Tub Pack)	500	
FNA88048NP	#8 x 1 1/2	100	
FNA88064NP	#8 x 2	100	
FNA88064NP250	#8 x 2 (Tub Pack)	250	
FNA03016NP	#10 x 1/2 (1/4 AF)	100	
FNA03016RNP	#10 x 1/2 (5/16 AF)	100	
FNA03024NP	#10 x 3/4 (1/4 AF)	100	
FNA03024RNP	#10 x 3/4 (5/16 AF)	100	
FNA03032NP	#10 x 1 (1/4 AF)	100	
FNA03032RNP	#10 x 1 (5/16 AF)	100	
FNA03040NP	#10 x 1 1/4	100	
FNA03048NP	#10 x 1 1/2	100	
FNA03048RNP	#10 x 1 1/2 (5/16 AF)	100	

# SLOTTED OVAL SHEET METAL SCREW

ZINC PLATED

Line: 220-00

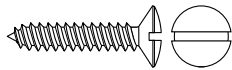

PART NUMBER	SIZE	QTY/BX	LIST PRICE
FPA44012	#4 x 3/8	100	
FPA44016	#4 x 1/2	100	
FPA44020	#4 x 5/8	100	
FPA44024	#4 x 3/4	100	
FPA44032	#4 x 1	100	
FPA44040X	#4 x 1 1/4	100	
FPA66008	#6 x 1/4	100	
FPA66012	#6 x 3/8	100	
FPA66016	#6 x 1/2	100	
FPA66020	#6 x 5/8	100	
FPA66024	#6 x 3/4	100	
FPA66028	#6 x 7/8	100	
FPA66032	#6 x 1	100	
FPA66040	#6 x 1 1/4	100	
FPA66048	#6 x 1 1/2	100	
FPA66056X	#6 x 1 3/4	100	
FPA77016J	#7 x 1/2	100	
FPA77024X	#7 x 3/4	100	
FPA77028	#7 x 7/8	100	
FPA77032X	#7 x 1	100	
FPA88012	#8 x 3/8	100	
FPA88016	#8 x 1/2	100	
FPA88020	#8 x 5/8	100	
FPA88024	#8 x 3/4	100	
FPA88028	#8 x 7/8	100	
FPA88032	#8 x 1	100	
FPA88040	#8 x 1 1/4	100	
FPA88048	#8 x 1 1/2	100	
FPA88064	#8 x 2	100	
FPA03012	#10 x 3/8	100	
FPA03016	#10 x 1/2	100	
FPA03020	#10 x 5/8	100	
FPA03024	#10 x 3/4	100	
FPA03028	#10 x 7/8	100	
FPA03032	#10 x 1	100	
FPA03040	#10 x 1 1/4	100	
FPA03048	#10 x 1 1/2	100	
FPA03056X	#10 x 1 3/4	100	
FPA03064X	#10 x 2	100	
FPA21012X	#12 x 3/8	100	
FPA21016	#12 x 1/2	100	
FPA21020	#12 x 5/8	100	
FPA21024	#12 x 3/4	100	
FPA21028	#12 x 7/8	100	

(continued...)

# SLOTTED OVAL SHEET METAL SCREW (cont.)

ZINC PLATED

Line: 220-00

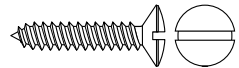

PART NUMBER	SIZE	QTY/BX	LIST PRICE
FPA21032	#12 x 1	100	
FPA21040	#12 x 1 1/4	100	
FPA21048	#12 x 1 1/2	100	
FPA21064	#12 x 2	100	
FPA04016	#14 x 1/2	100	
FPA04020X	#14 x 5/8	100	
FPA04024	#14 x 3/4	100	
FPA04028	#14 x 7/8	100	
FPA04032	#14 x 1	100	
FPA04040	#14 x 1 1/4	100	
FPA04048	#14 x 1 1/2	100	
FPA04056	#14 x 1 3/4	50	
FPA04064	#14 x 2	50	

# PHILLIPS PAN SHEET METAL SCREW

ZINC PLATED

Line: 221-00

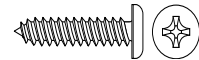

PART NUMBER	SIZE	QTY/BX	LIST PRICE
FRA44008	#4 x 1/4	100	
FRA44012	#4 x 3/8	100	
FRA44016	#4 x 1/2	100	
FRA44020	#4 x 5/8	100	
FRA44024	#4 x 3/4	100	
FRA44028	#4 x 7/8	100	
FRA44032	#4 x 1	100	
FRA66008	#6 x 1/4	100	
FRA66012	#6 x 3/8	100	
FRA66016	#6 x 1/2	100	
FRA66020	#6 x 5/8	100	
FRA66024	#6 x 3/4	100	
FRA66028	#6 x 7/8	100	
FRA66032	#6 x 1	100	
FRA66040	#6 x 1 1/4	100	
FRA66048	#6 x 1 1/2	100	
FRA66056	#6 x 1 3/4	100	
FRA66064	#6 x 2	100	
FRA77012	#7 x 3/8	100	
FRA77016	#7 x 1/2	100	
FRA77020	#7 x 5/8	100	
FRA77024	#7 x 3/4	100	
FRA77028	#7 x 7/8	100	
FRA77032	#7 x 1	100	
FRA77040	#7 x 1 1/4	100	

**PHILLIPS PAN SHEET METAL SCREW (cont.)**

ZINC PLATED

Line: 221-00

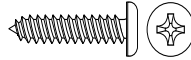

PART NUMBER	SIZE	QTY/BX	LIST PRICE
FRA77048	#7 x 1 1/2	100	
FRA88008	#8 x 1/4 (Type AB)	100	
FRA88012	#8 x 3/8	100	
FRA88016	#8 x 1/2	100	
FRA88020	#8 x 5/8	100	
FRA88024	#8 x 3/4	100	
FRA88028	#8 x 7/8	100	
FRA88032	#8 x 1	100	
FRA88040	#8 x 1 1/4	100	
FRA88048	#8 x 1 1/2	100	
FRA88056	#8 x 1 3/4	100	
FRA88064	#8 x 2	100	
FRA88080	#8 x 2 1/2	100	
FRA88096	#8 x 3	100	
FRA03008	#10 x 1/4	100	
FRA03012	#10 x 3/8	100	
FRA03016	#10 x 1/2	100	
FRA03020	#10 x 5/8	100	
FRA03024	#10 x 3/4	100	
FRA03028	#10 x 7/8	100	
FRA03032	#10 x 1	100	
FRA03040	#10 x 1 1/4	100	
FRA03048	#10 x 1 1/2	100	
FRA03056X	#10 x 1 3/4	100	
FRA03064	#10 x 2	100	
FRA03080	#10 x 2 1/2	50	
FRA03096	#10 x 3	50	
FRA21016	#12 x 1/2	100	
FRA21020	#12 x 5/8	100	
FRA21024	#12 x 3/4	100	
FRA21028	#12 x 7/8	100	
FRA21032	#12 x 1	100	
FRA21040	#12 x 1 1/4	100	
FRA21048	#12 x 1 1/2	100	
FRA21056	#12 x 1 3/4	50	
FRA21064	#12 x 2	50	
FRA21080	#12 x 2 1/2	50	
FRA21096	#12 x 3	50	
FRA04012	#14 x 3/8	100	
FRA04016	#14 x 1/2 (Type AB)	100	
FRA04020	#14 x 5/8	100	
FRA04024	#14 x 3/4	100	
FRA04028	#14 x 7/8	100	
FRA04032	#14 x 1	100	

(continued...)

**PHILLIPS PAN SHEET METAL SCREW (cont.)**

ZINC PLATED

Line: 221-00

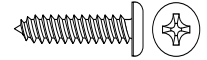

PART NUMBER	SIZE	QTY/BX	LIST PRICE
FRA04040	#14 x 1 1/4	100	
FRA04048	#14 x 1 1/2	100	
FRA04056	#14 x 1 3/4	50	
FRA04064	#14 x 2	50	
FRA04080	#14 x 2 1/2	50	
FRA04096	#14 x 3	50	

**PHILLIPS PAN SHEET METAL SCREW**

BLACK OXIDE

Line: 221-01

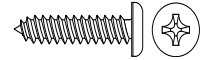

PART NUMBER	SIZE	QTY/BX	LIST PRICE
FRA66048B0	#6 x 1 1/2	100	
FRA88008B0	#8 x 1/4 (Type AB)	100	
FRA21016B0	#12 x 1/2	100	
FRA21056B0	#12 x 1 3/4	25	
FRA04048B0	#14 x 1 1/2	25	
FRA04064B0	#14 x 2	25	

## PHILLIPS ROUND SHEET METAL SCREW

ZINC PLATED

Line: 222-00

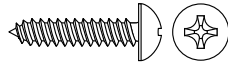

PART NUMBER	SIZE	QTY/BX	LIST PRICE
FSA44012	#4 x 3/8	100	
FSA44016	#4 x 1/2	100	
FSA44020	#4 x 5/8	100	
FSA44024	#4 x 3/4	100	
FSA66008	#6 x 1/4	100	
FSA66012	#6 x 3/8	100	
FSA66016	#6 x 1/2	100	
FSA66020	#6 x 5/8	100	
FSA66024	#6 x 3/4	100	
FSA66028	#6 x 7/8	100	
FSA66032	#6 x 1	100	
FSA77020	#7 x 5/8	100	
FSA88012	#8 x 3/8	100	
FSA88016	#8 x 1/2	100	
FSA88020	#8 x 5/8	100	
FSA88024	#8 x 3/4	100	
FSA88028	#8 x 7/8	100	
FSA88040	#8 x 1 1/4	100	
FSA88048	#8 x 1 1/2	100	
FSA03016	#10 x 1/2	100	
FSA03020	#10 x 5/8	100	
FSA03024	#10 x 3/4	100	
FSA03028	#10 x 7/8	100	
FSA03032	#10 x 1	100	
FSA03040	#10 x 1 1/4	100	
FSA03048	#10 x 1 1/2	100	
FSA03064	#10 x 2	100	
FSA21016	#12 x 1/2	100	
FSA21020	#12 x 5/8	100	
FSA21024	#12 x 3/4	100	
FSA21040	#12 x 1 1/4	100	
FSA21048	#12 x 1 1/2	100	
FSA04016	#14 x 1/2	100	
FSA04024	#14 x 3/4	100	
FSA04032	#14 x 1	100	
FSA04040	#14 x 1 1/4	100	

## PHILLIPS FLAT SHEET METAL SCREW

ZINC PLATED

Line: 223-00

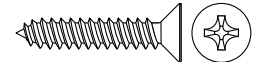

PART NUMBER	SIZE	QTY/BX	LIST PRICE
FTA44008	#4 x 1/4	100	
FTA44008UC	#4 x 1/4 (Undercut)	100	
FTA44012	#4 x 3/8	100	
FTA44016	#4 x 1/2	100	
FTA44020	#4 x 5/8	100	
FTA44024	#4 x 3/4	100	
FTA44032	#4 x 1	100	
FTA44040	#4 x 1 1/4	100	
FTA44048	#4 x 1 1/2	100	
FTA66008	#6 x 1/4	100	
FTA66008UC	#6 x 1/4 (Undercut)	100	
FTA66012	#6 x 3/8	100	
FTA66016	#6 x 1/2	100	
FTA66020	#6 x 5/8	100	
FTA66024	#6 x 3/4	100	
FTA66028	#6 x 7/8	100	
FTA66032	#6 x 1	100	
FTA66040	#6 x 1 1/4	100	
FTA66048	#6 x 1 1/2	100	
FTA66056	#6 x 1 3/4	100	
FTA66064	#6 x 2	100	
FTA66080	#6 x 2 1/2	50	
FTA66096	#6 x 3	50	
FTA77012	#7 x 3/8	100	
FTA77016	#7 x 1/2	100	
FTA77024	#7 x 3/4	100	
FTA88012	#8 x 3/8	100	
FTA88014	#8 x 7/16	100	
FTA88016	#8 x 1/2	100	
FTA88020	#8 x 5/8	100	
FTA88024	#8 x 3/4	100	
FTA88028X	#8 x 7/8	100	
FTA88032	#8 x 1	100	
FTA88040	#8 x 1 1/4	100	
FTA88048	#8 x 1 1/2	100	
FTA88056	#8 x 1 3/4	100	
FTA88064	#8 x 2	100	
FTA88080	#8 x 2 1/2	50	
FTA88096	#8 x 3	100	
FTA03012	#10 x 3/8	100	
FTA03012UC	#10 x 3/8 (Undercut)	100	
FTA03016	#10 x 1/2	100	
FTA03016UC	#10 x 1/2 (Undercut)	100	
FTA03020	#10 x 5/8	100	

(continued...)

**PHILLIPS FLAT SHEET METAL SCREW (cont.)**

ZINC PLATED

Line: 223-00

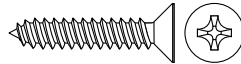

PART NUMBER	SIZE	QTY/BX	LIST PRICE
FTA03024	#10 x 3/4	100	
FTA03028X	#10 x 7/8	100	
FTA03032	#10 x 1	100	
FTA03040	#10 x 1 1/4	100	
FTA03048	#10 x 1 1/2	100	
FTA03056	#10 x 1 3/4	100	
FTA03064	#10 x 2	100	
FTA03072	#10 x 2 1/4	100	
FTA03080	#10 x 2 1/2	50	
FTA03096	#10 x 3	50	
FTA21016	#12 x 1/2 (Undercut)	100	
FTA21020	#12 x 5/8	100	
FTA21024	#12 x 3/4	100	
FTA21028	#12 x 7/8	100	
FTA21032	#12 x 1	100	
FTA21040	#12 x 1 1/4	100	
FTA21048	#12 x 1 1/2	100	
FTA21056	#12 x 1 3/4	50	
FTA21064	#12 x 2	50	
FTA21080	#12 x 2 1/2	50	
FTA21096	#12 x 3	50	
FTA21112	#12 x 3 1/2	50	
FTA04016	#14 x 1/2 (Undercut)	100	
FTA04020	#14 x 5/8 (Undercut)	100	
FTA04024	#14 x 3/4	100	
FTA04028	#14 x 7/8	100	
FTA04032	#14 x 1	100	
FTA04040	#14 x 1 1/4	100	
FTA04048	#14 x 1 1/2	100	
FTA04056	#14 x 1 3/4	50	
FTA04064	#14 x 2	50	
FTA04080	#14 x 2 1/2	50	
FTA04096	#14 x 3	50	

**PHILLIPS FLAT SHEET METAL SCREW**

BLACK OXIDE

Line: 223-01

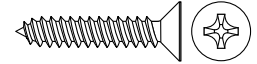

PART NUMBER	SIZE	QTY/BX	LIST PRICE
FTA44024B0	#4 x 3/4 (Type AB)	100	
FTA66020B0	#6 x 5/8	100	
FTA66040B0	#6 x 1 1/4	100	
FTA66048B0	#6 x 1 1/2	100	
FTA88012B0	#8 x 3/8 (Undercut)	100	
FTA88020B0	#8 x 5/8	100	
FTA88064B0	#8 x 2	50	
FTA88080B0	#8 x 2 1/2	25	
FTA03040B0	#10 x 1 1/4	50	
FTA03048B0	#10 x 1 1/2	50	
FTA03064B0	#10 x 2	25	
FTA03080B0	#10 x 2 1/2	25	
FTA03096B0	#10 x 3	25	

## PHILLIPS TRUSS SHEET METAL SCREW

ZINC PLATED

Line: 224-00



PART NUMBER	SIZE	QTY/BX	LIST PRICE
FUA44012	#4 x 3/8	100	
FUA66008X	#6 x 1/4	100	
FUA66012	#6 x 3/8	100	
FUA66016	#6 x 1/2	100	
FUA66020	#6 x 5/8	100	
FUA66024	#6 x 3/4	100	
FUA66032	#6 x 1	100	
FUA66040	#6 x 1 1/4	100	
FUA88012	#8 x 3/8	100	
FUA88016	#8 x 1/2	100	
FUA88016BZ	#8 x 1/2 (Type AB, Black Zinc)	1000	
FUA88020	#8 x 5/8	100	
FUA88024	#8 x 3/4	100	
FUA88032	#8 x 1	100	
FUA88040	#8 x 1 1/4	100	
FUA88048	#8 x 1 1/2	100	
FUA03012	#10 x 3/8	100	
FUA03016	#10 x 1/2	100	
FUA03020	#10 x 5/8	100	
FUA03024	#10 x 3/4	100	
FUA03032	#10 x 1	100	
FUA03040	#10 x 1 1/4	100	
FUA03048	#10 x 1 1/2	100	
FUA03064	#10 x 2	100	
FUA21016	#12 x 1/2	100	
FUA21020	#12 x 5/8	100	
FUA21024	#12 x 3/4	100	
FUA21032	#12 x 1	100	
FUA21048	#12 x 1 1/2	100	
FUA04020	#14 x 5/8	100	
FUA04024	#14 x 3/4	100	
FUA04032	#14 x 1	100	
FUA04048	#14 x 1 1/2	100	

## PHILLIPS OVAL SHEET METAL SCREW

ZINC PLATED

Line: 225-00

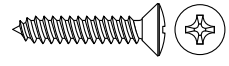

PART NUMBER	SIZE	QTY/BX	LIST PRICE
FVA44012	#4 x 3/8	100	
FVA44016	#4 x 1/2	100	
FVA44020	#4 x 5/8	100	
FVA44024	#4 x 3/4	100	
FVA66012	#6 x 3/8	100	
FVA66016	#6 x 1/2	100	
FVA66020	#6 x 5/8	100	
FVA66024	#6 x 3/4	100	
FVA66028	#6 x 7/8	100	
FVA66032	#6 x 1	100	
FVA66040	#6 x 1 1/4	100	
FVA66048	#6 x 1 1/2	100	
FVA77012	#7 x 3/8	100	
FVA77016	#7 x 1/2	100	
FVA77024	#7 x 3/4	100	
FVA88012	#8 x 3/8	100	
FVA88016	#8 x 1/2	100	
FVA88016BOX	#8 x 1/2 (Black Oxide)	100	
FVA88020	#8 x 5/8	100	
FVA88024	#8 x 3/4	100	
FVA88028	#8 x 7/8	100	
FVA88032	#8 x 1	100	
FVA88040	#8 x 1 1/4	100	
FVA88040J	#8 x 1 1/4 (Black Oxide)	100	
FVA88048	#8 x 1 1/2	100	
FVA88048BOX	#8 x 1 1/2 (Black Oxide)	50	
FVA88056	#8 x 1 3/4	100	
FVA88064	#8 x 2	100	
FVA88080	#8 x 2 1/2	100	
FVA03048B0	#10 x 1 1/2 (Black Oxide)	100	
FVA03012	#10 x 3/8	100	
FVA03016	#10 x 1/2	100	
FVA03016BOX	#10 x 1/2 (Black Oxide)	100	
FVA03020	#10 x 5/8	100	
FVA03024	#10 x 3/4	100	
FVA03024BOX	#10 x 3/4 (Black Oxide)	100	
FVA03028	#10 x 7/8	100	
FVA03032	#10 x 1	100	
FVA03032BOX	#10 x 1 (Black Oxide)	100	
FVA03040	#10 x 1 1/4	100	
FVA03048	#10 x 1 1/2	100	
FVA03056	#10 x 1 3/4	100	
FVA03064	#10 x 2	100	
FVA03072X	#10 x 2 1/4	50	

(continued...)

**PHILLIPS OVAL SHEET METAL SCREW (cont.)**

ZINC PLATED

Line: 225-00



PART NUMBER	SIZE	QTY/BX	LIST PRICE
FVA03080X	#10 x 2 1/2	50	
FVA21016	#12 x 1/2	100	
FVA21020X	#12 x 5/8	100	
FVA21024	#12 x 3/4	100	
FVA21032	#12 x 1	100	
FVA21040	#12 x 1 1/4	100	
FVA21048	#12 x 1 1/2	100	
FVA21056	#12 x 1 3/4	50	
FVA21064	#12 x 2	50	
FVA04016X	#14 x 1/2	100	
FVA04020	#14 x 5/8	100	
FVA04024	#14 x 3/4	100	
FVA04032	#14 x 1	100	
FVA04040	#14 x 1 1/4	100	
FVA04048	#14 x 1 1/2	100	
FVA04064	#14 x 2	50	

**SQUARE DRIVE PAN TAPPING SCREW**

ZINC PLATED

Line: 225-03

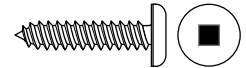

PART NUMBER	SIZE	QTY/BX	LIST PRICE
BBL66012	#6 x 3/8	100	
BBL66016	#6 x 1/2	100	
BBL66020	#6 x 5/8	100	
BBL66024	#6 x 3/4	100	
BBL66032	#6 x 1	100	
BBL66040	#6 x 1 1/4	100	
BBL66048	#6 x 1 1/2	100	
BBL88012	#8 x 3/8	100	
BBL88016	#8 x 1/2	100	
BBL88020	#8 x 5/8	100	
BBL88024	#8 x 3/4	100	
BBL88032	#8 x 1	100	
BBL88040	#8 x 1 1/4	100	
BBL88048	#8 x 1 1/2	100	
BBL88064	#8 x 2	50	
BBL03012	#10 x 3/8	100	
BBL03016	#10 x 1/2	100	
BBL03020	#10 x 5/8	100	
BBL03024	#10 x 3/4	100	
BBL03032	#10 x 1	100	
BBL03040	#10 x 1 1/4	100	
BBL03048	#10 x 1 1/2	100	
BBL03064	#10 x 2	100	
BBL03080	#10 x 2 1/2	50	
BBL03096	#10 x 3	100	
BBL21016	#12 x 1/2	100	
BBL21020	#12 x 5/8	100	
BBL21024	#12 x 3/4	100	
BBL21032	#12 x 1	100	
BBL21040	#12 x 1 1/4	100	
BBL21048	#12 x 1 1/2	100	
BBL21064	#12 x 2	50	
BBL21080	#12 x 2 1/2	50	
BBL21096	#12 x 3	50	

## COMBINATION SLOT PAN SHEET METAL SCREW

ZINC PLATED  
Line: 226-01

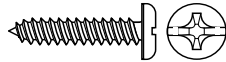

PART NUMBER	SIZE	QTY/BX	LIST PRICE
APD44008	#4 x 1/4	100	
APD44012	#4 x 3/8	100	
APD44016	#4 x 1/2	100	
APD44020	#4 x 5/8	100	
APD44024	#4 x 3/4	100	
APD44032	#4 x 1	100	
APD66008	#6 x 1/4	100	
APD66012	#6 x 3/8	100	
APD66016	#6 x 1/2	100	
APD66020	#6 x 5/8	100	
APD66024	#6 x 3/4	100	
APD66032	#6 x 1	100	
APD66040	#6 x 1 1/4	100	
APD66048	#6 x 1 1/2	100	
APD66064	#6 x 2	100	
APD77012	#7 x 3/8	100	
APD77016	#7 x 1/2	100	
APD77020	#7 x 5/8	100	
APD77024	#7 x 3/4	100	
APD77032	#7 x 1	100	
APD88012	#8 x 3/8	100	
APD88016	#8 x 1/2	100	
APD88020	#8 x 5/8	100	
APD88024	#8 x 3/4	100	
APD88032	#8 x 1	100	
APD88040	#8 x 1 1/4	100	
APD88048	#8 x 1 1/2	100	
APD88056	#8 x 1 3/4	100	
APD88064	#8 x 2	100	
APD88080	#8 x 2 1/2	100	
APD88096	#8 x 3	100	
APD03012	#10 x 3/8	100	
APD03016	#10 x 1/2	100	
APD03020	#10 x 5/8	100	
APD03024	#10 x 3/4	100	
APD03032	#10 x 1	100	
APD03040	#10 x 1 1/4	100	
APD03048	#10 x 1 1/2	100	
APD03056	#10 x 1 3/4	100	
APD03064	#10 x 2	100	
APD03080	#10 x 2 1/2	100	
APD03096	#10 x 3	100	
APD21016	#12 x 1/2	100	
APD21020	#12 x 5/8	100	

(continued...)

## COMBINATION SLOT PAN SHEET METAL SCREW (cont.)

ZINC PLATED  
Line: 226-01

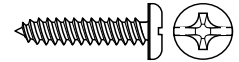

PART NUMBER	SIZE	QTY/BX	LIST PRICE
APD21024	#12 x 3/4	100	
APD21032	#12 x 1	100	
APD21040	#12 x 1 1/4	100	
APD21048	#12 x 1 1/2	100	
APD21056	#12 x 1 3/4	100	
APD21064	#12 x 2	100	
APD21080	#12 x 2 1/2	50	
APD21096	#12 x 3	50	
APD04016	#14 x 1/2	100	
APD04020	#14 x 5/8	100	
APD04024	#14 x 3/4	100	
APD04032	#14 x 1	100	
APD04040	#14 x 1 1/4	100	
APD04048	#14 x 1 1/2	100	
APD04056	#14 x 1 3/4	100	
APD04064	#14 x 2	100	
APD04080	#14 x 2 1/2	50	
APD04096	#14 x 3	50	

## #4 HEAD PHILLIPS OVAL TRIM SCREWS

ZINC PLATED  
Line: 227-00

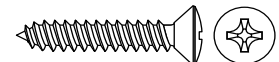

PART NUMBER	SIZE	QTY/BX	LIST PRICE
FWA44032	#4 x 1	100	
FWA66016	#6 x 1/2	100	
FWA66024	#6 x 3/4	100	



**CALL - 1 (800) 723-2826**



## #6 HEAD PHILLIPS OVAL TRIM SCREWS

ZINC PLATED

Line: 228-00



PART NUMBER	SIZE	QTY/BX	LIST PRICE
FXA88012	#8 x 3/8	100	
FXA88016	#8 x 1/2	100	
FXA88020	#8 x 5/8	100	
FXA88032	#8 x 1	100	
FXA88040	#8 x 1 1/4	100	
FXA88048	#8 x 1 1/2	100	
FXA88056	#8 x 1 3/4	100	
FXA88064	#8 x 2	100	
FXA88072	#8 x 2 1/4	100	
FXA88080	#8 x 2 1/2	100	
FXA88128	#8 x 4	50	
FXA03016	#10 x 1/2	100	
FXA03020	#10 x 5/8	100	
FXA03024	#10 x 3/4	100	
FXA03032	#10 x 1	100	
FXA03040	#10 x 1 1/4	100	
FXA03048	#10 x 1 1/2	100	
FXA03056	#10 x 1 3/4	100	

## #10 HEAD PHILLIPS OVAL TRIM SCREWS

ZINC PLATED

Line: 229-00

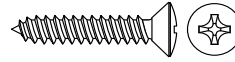

PART NUMBER	SIZE	QTY/BX	LIST PRICE
FYA21016X	#12 x 1/2	100	
FYA21024	#12 x 3/4	100	
FYA8055AX	#12 x 1	100	
FYA8081AX	#14 x 1	100	
FYA04056	#14 x 1 3/4	50	

## #8 HEAD PHILLIPS OVAL TRIM SCREWS

ZINC PLATED

Line: 230-00



PART NUMBER	SIZE	QTY/BX	LIST PRICE
FYA03016	#10 x 1/2	100	
FYA03020	#10 x 5/8	100	
FYA03024	#10 x 3/4	100	
FYA03032	#10 x 1	100	
FYA03040	#10 x 1 1/4	100	
FYA03048	#10 x 1 1/2	100	
FYA03056	#10 x 1 3/4	100	
FYA03064	#10 x 2	100	
FYA03072X	#10 x 2 1/4	100	
FYA03080	#10 x 2 1/2	100	
FYA21064	#12 x 2	100	

## #6 HEAD PHILLIPS OVAL TRIM SCREWS

CHROME

Line: 231-00

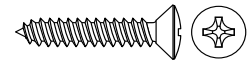

PART NUMBER	SIZE	QTY/BX	LIST PRICE
FAD2292J	#8 x 3/8	100	
FAD2294J	#8 x 1/2	100	
FAD2296J	#8 x 5/8	100	
FAD2298J	#8 x 3/4	100	
FXA88024	#8 x 3/4	100	
FAD2300J	#8 x 1	100	
FAD2302J	#8 x 1 1/4	100	
FAD2304J	#8 x 1 1/2	100	
FAD2306J	#8 x 1 3/4	100	
FAD2307J	#8 x 2	100	
FAD3980J	#10 x 1/2	100	
FAD3981J	#10 x 3/4	100	
FAD2315J	#10 x 1	100	
FAD2318J	#10 x 1 1/4	100	

## #8 HEAD PHILLIPS OVAL TRIM SCREWS

CHROME

Line: 232-00



PART NUMBER	SIZE	QTY/BX	LIST PRICE
FAD2311J	#10 x 1/2	100	
FAD2313J	#10 x 3/4	100	
FAD2316J	#10 x 1	100	
FAD2319J	#10 x 1 1/4	100	
FAD2322J	#10 x 1 1/2	100	
FAD2325J	#10 x 1 3/4	100	
FAD2327J	#10 x 2	100	
FAD2329J	#10 x 2 1/2	100	

## PHILLIPS OVAL HEAD SHEET METAL SCREWS

CHROME

Line: 234-00



PART NUMBER	SIZE	QTY/BX	LIST PRICE
FAD2288J	#6 x 1/2	100	
FAD2289J	#6 x 3/4	100	
FAD2290J	#6 x 1	100	
FAD2293J	#8 x 1/2	100	
FAD2297J	#8 x 3/4	100	
FAD2299J	#8 x 1	100	
FAD2301J	#8 x 1 1/4	100	
FAD2303J	#8 x 1 1/2	100	
FAD2305J	#8 x 1 3/4	100	
FAD2308J	#8 x 2 1/4	100	
FAD1785J	#10 x 3/8	100	
FAD2310J	#10 x 1/2	100	
FAD2312J	#10 x 3/4	100	
FAD2314J	#10 x 1	100	
FAD2317J	#10 x 1 1/4	100	
FAD2320J	#10 x 1 1/2	100	
FAD2323J	#10 x 1 3/4	100	
FAD2326J	#10 x 2	100	
FAD2328J	#10 x 2 1/2	100	
FAD21048	#12 x 1 1/2	100	
FAD21064	#12 x 2 (Trim Screw, Chrome)	100	

## HEX HEAD SELF SEALING SHEET METAL SCREWS

ZINC PLATED

Line: 236-00



PART NUMBER	SIZE	QTY/BX	LIST PRICE
GUA03020	#10 x 5/8 (5/16 AF)	100	
GUA03024	#10 x 3/4 (1/4 AF)	100	
GUA03032	#10 x 1 (1/4 AF)	100	
GUA03040	#10 x 1 1/4	100	
GUA03048	#10 x 1 1/2 (1/4 AF)	100	
GUA03064	#10 x 2	100	
GUA21024	#12 x 3/4	100	
GUA21032	#12 x 1	100	
GUA21040	#12 x 1 1/4	100	
GUA21048	#12 x 1 1/2	100	
GUA21064	#12 x 2	50	
GUA04024	#14 x 3/4	100	
GUA04032	#14 x 1	100	
GUA04040	#14 x 1 1/4	100	
GUA04048	#14 x 1 1/2	100	
GUA04048BT	#14 x 1 1/2 (Type 'B')	100	
GUA04064	#14 x 2	100	
GUA04080	#14 x 2 1/2	100	
GUA04096	#14 x 3	100	

## HEX HEAD SELF SEALING TAPPING SCREWS

410 STAINLESS STEEL

Line: 236-01

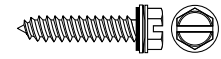

PART NUMBER	SIZE	QTY/BX	LIST PRICE
ARW04024	#14 x 3/4	100	
ARW04032	#14 x 1	100	
ARW04040	#14 x 1 1/4	100	
ARW04048	#14 x 1 1/2	100	
ARW04048BPT	#14 x 1 1/2 (Type 'B')	100	
ARW04056	#14 x 1 3/4	100	
ARW04064	#14 x 2	100	
ARW04064LRGW	#14 x 2 (1 1/8 Washer)	100	
ARW04080	#14 x 2 1/2	50	
ARW04080LRGW	#14 x 2 1/2 (1 1/8 Washer)	100	
ARW04096	#14 x 3	50	
ARW04096LRGW	#14 x 3 (1 1/8 Washer)	100	
ARW04112LRGW	#14 x 3 1/2 (1 1/8 Washer)	100	
ARW04128LRGW	#14 x 4 (1 1/8 Washer)	50	
ARW04144LRGW	#14 x 4 1/2 (1 1/8 Washer)	50	
ARW04160LRGW	#14 x 5 (1 1/8 Washer)	50	

## HEX HEAD SELF SEALING TAPPING SCREWS

316 STAINLESS STEEL

Line: 236-02

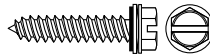

PART NUMBER	SIZE	QTY/BX	LIST PRICE
AZV04024	#14 x 3/4	100	
AZV04032	#14 x 1	100	
AZV04040	#14 x 1 1/4	100	
AZV04048	#14 x 1 1/2	100	

## HEX HEAD TAPPING SCREW W/NEOPRENE WASHER

18-8 STAINLESS STEEL

Line: 236-03



PART NUMBER	SIZE	QTY/BX	LIST PRICE
BEE04024	#14 x 3/4	100	
BEE04032	#14 x 1	100	
BEE04040	#14 x 1 1/4	100	
BEE04048	#14 x 1 1/2	100	
BEE04056	#14 x 1 3/4	100	
BEE04064	#14 x 2	100	
BEE04080	#14 x 2 1/2	50	
BEE04096	#14 x 3	50	

## HEX HEAD SELF SEALING DRILL SCREWS

ZINC PLATED

Line: 237-00



PART NUMBER	SIZE	QTY/BX	LIST PRICE
GVA88016	#8 x 1/2 (#2pt.)	100	
GVA03016	#10 x 1/2 (#2pt)	100	
GVA03020	#10 x 5/8 (#2pt.)	100	
GVA03024	#10 x 3/4 (#3pt.)	100	
GVA03032	#10 x 1 (#3pt.)	100	
GVA03040	#10 x 1 1/4 (#3pt.)	100	
GVA03048	#10 x 1 1/2 (#3pt.)	100	
GVA03064	#10 x 2 (#3pt.)	100	
GVA21024	#12-24 x 3/4 (#3pt.)	100	
GVA12240284	#12-24 x 7/8 (#4pt.)	100	
GVA21032	#12-24 x 1 (#3pt.)	100	
GVA210324	#12-24 x 1 (#4pt.)	100	
GVA21040	#12-24 x 1 1/4 (#3pt.)	100	
GVA210404	#12-24 x 1 1/4 (#4pt.)	100	
GVA12240405	#12-24 x 1 1/4 (#5pt.)	100	
GVA21048	#12-24 x 1 1/2 (#3pt.)	100	
GVA210485	#12-24 x 1 1/2 (#5pt.)	100	
GVA21064	#12-24 x 2 (#3pt.)	100	
GVA210645	#12-24 x 2 (#5pt.)	100	
GVA21080	#12-24 x 2 1/2 (#3pt.)	100	
GVA21096	#12-24 x 3 (#3pt.)	100	
GVA04024	#14 x 3/4 (#3pt.)	100	
GVA04032	#14 x 1 (#3pt.)	100	
GVA04040	#14 x 1 1/4 (#3pt.)	100	
GVA04048	#14 x 1 1/2 (#3pt.)	100	
GVA04056	#14 x 1 3/4 (#3pt.)	100	
GVA04064	#14 x 2 (#3pt.)	50	
GVA04080	#14 x 2 1/2 (#3pt.)	50	
GVA04096	#14 x 3 (#3pt.)	50	
GVA04128	#14 x 4 (#3pt.)	50	
GVA04160	#14 x 5 (#3pt.)	50	
GVA88020	8 x 5/8 (#2pt.)	100	
GVA88024	8 x 3/4 (#2pt.)	100	
GVA88032	8 x 1 (#2pt.)	100	
GVA88040	8 x 1 1/4 (#2pt.)	100	
GVA88048	8 x 1 1/2 (#2pt.)	100	
GVA88064	8 x 2 (#2pt.)	100	

## METAL BACKED NEOPRENE SELF SEAL WASHER

GALVANIZED OR STAINLESS STEEL BACKING

Line: 237-01



PART NUMBER	SIZE	QTY/BX	LIST PRICE
JZX88	#8 x 1/2 (Galv)	100	
JZX088SS	#8 x 1/2 (S/S)	100	
JZX03	#10 x 1/2 (Galv)	100	
JZX03SS	#10 x 1/2 (S/S)	100	
JZX03020	#10 x 5/8 (Galv)	100	
JZX21	#12 x 5/8 (Galv)	100	
JZX021SS	#12 x 5/8 (S/S)	100	
JZX04	#14 x 5/8 (Galv)	100	
JZX04SS	#14 x 5/8 (S/S)	100	
JZX04032	#14 x 1 (Galv)	100	
JZX04032SS	#14 x 1 (S/S)	100	
JZX04036	#14 x 1 1/8 (Galv)	100	
JZX04036SS	#14 x 1 1/8 (S/S)	100	
JZX05	5/16 x 3/4 (Galv)	100	
JZX05024SS	5/16 x 3/4 (S/S)	100	
JZX06024	3/8 x 3/4 (Galv)	100	
JZX06024SS	3/8 x 3/4 (S/S)	100	
JZX06036	3/8 x 1 1/8 (Galv)	100	
JZX08032	1/2 x 1 (Galv)	100	
JZX08064SS	1/2 x 2 (S/S)	50	
JZX12040SS	3/4 x 1 1/4 (S/S)	50	
JZX12048SS	3/4 x 1 1/2 (S/S)	100	

## HEX #2 PT DRILL SCREW BULK PAK

ZINC PLATED

Line: 237-95



PART NUMBER	SIZE	QTY/BX	LIST PRICE
GZA66012BPK	#6 x 3/8	20000	
GZA66016BPK	#6 x 1/2	15000	
GZA66020BPK	#6 x 5/8	15000	
GZA66024BPK	#6 x 3/4	10000	
GZA66032BPK	#6 x 1	10000	
GZA66040BPK	#6 x 1 1/4	10000	
GZA66048BPK	#6 x 1 1/2	8000	
GZA88016BPK	#8 x 1/2	10000	
GZA88020BPK	#8 x 5/8	10000	
GZA88024BPK	#8 x 3/4	10000	
GZA88032BPK	#8 x 1	8000	
GZA88040BPK	#8 x 1 1/4	6000	
GZA88048BPK	#8 x 1 1/2	5000	
GZA88064BPK	#8 x 2	4000	
GZA03016BPK	#10 x 1/2	8000	
GZA03020BPK	#10 x 5/8	8000	

## #2 POINT DRILL SCREW

ZINC PLATED

Line: 238-00



PART NUMBER	SIZE	QTY/BX	LIST PRICE
GZA66012	#6 x 3/8	100	
GZA66016	#6 x 1/2	100	
GZA66020	#6 x 5/8	100	
GZA66024	#6 x 3/4	100	
GZA66032	#6 x 1	100	
GZA66040	#6 x 1 1/4	100	
GZA66048	#6 x 1 1/2	100	
GZA88016	#8 x 1/2	100	
GZA88020	#8 x 5/8	100	
GZA88024	#8 x 3/4	100	
GZA88032	#8 x 1	100	
GZA88040	#8 x 1 1/4	100	
GZA88048	#8 x 1 1/2	100	
GZA88056	#8 x 1 3/4	100	
GZA88064	#8 x 2	100	
GZA03016	#10 x 1/2	100	
GZA03020	#10 x 5/8	100	

## HEX SELF SEAL DRILL SCREW W/BONDED WASHER

410 STAINLESS STEEL

Line: 237-02



PART NUMBER	SIZE	QTY/BX	LIST PRICE
ARX88016	#8-18 x 1/2 #2	100	
ARX88024	#8-18 x 3/4 #2	100	
ARX88032	#8-18 x 1 #2	100	
ARX03016	#10-16 x 1/2 #3	100	
ARX03024	#10-16 x 3/4	100	
ARX03032	#10-16 x 1	100	
ARX03040	#10-16 x 1 1/4	100	
ARX21032	#12-14 x 1	100	
ARX21040	#12-14 x 1 1/4	100	
ARX04024	1/4-14 X 3/4	100	
ARX04032	1/4-14 X 1	100	
ARX04040	1/4-14 X 1 1/4	100	
ARX04048	1/4-14 X 1 1/2	100	
ARX04064	1/4-14 X 2	100	
ARX04096	1/4-14 X 3	50	

## #2 POINT DRILL SCREW

410 STAINLESS STEEL

Line: 238-01



PART NUMBER	SIZE	QTY/BX	LIST PRICE
ARY88016	#8-18 x 1/2	100	
ARY88020	#8-18 x 5/8	100	
ARY88024	#8-18 x 3/4	100	
ARY88032	#8-18 x 1	100	
ARY21024	#12-14 x 3/4	100	
ARY21032	#12-14 x 1	100	
ARY21040	#12-14 x 1 1/4	100	
ARY21048	#12-14 x 1 1/2	100	
ARY21064	#12-14 x 2	50	

## PK HEX WASH #2 PT DRIL-KWICK SCREW

ZINC PLATED

Line: 238-02



PART NUMBER	SIZE	QTY/BX	LIST PRICE
BZM66012	#6 x 3/8	100	
BZM66016	#6 x 1/2	100	
BZM66024	#6 x 3/4	100	
BZM88016	#8 x 1/2	100	
BZM88020	#8 x 5/8	100	
BZM88024	#8 x 3/4	100	
BZM88032	#8 x 1	100	
BZM88040	#8 x 1 1/4	100	
BZM88048	#8 x 1 1/2	100	
BZM03016	#10 x 1/2	100	
BZM03020	#10 x 5/8	100	
BZM03024	#10 x 3/4	100	
BZM03032	#10 x 1	100	
BZM03040	#10 x 1 1/4	100	
BZM03048	#10 x 1 1/2	100	
BZM04024	#14 x 3/4	100	
BZM04032	#14 x 1	100	

## #3 POINT DRILL SCREW

ZINC PLATED - BULK PACKAGE

Line: 238-95



PART NUMBER	SIZE	QTY/BX	LIST PRICE
HAA03016BPK	#10 x 1/2	8500	
HAA03020BPK	#10 x 5/8	7500	
HAA03024BPK	#10 x 3/4	7000	
HAA03032BPK	#10 x 1	7000	
HAA03040BPK	#10 x 1 1/4	5000	
HAA03048BPK	#10 x 1 1/2	4000	
HAA03064BPK	#10 x 2	2500	
HAA21024BPK	#12 x 3/4	4000	
HAA21032BPK	#12 x 1	4000	
HAA21040BPK	#12 x 1 1/4	3500	
HAA21048BPK	#12 x 1 1/2	2000	
HAA21064BPK	#12 x 2	3000	
HAA21080BPK	#12 x 2 1/2	1500	
HAA21096BPK	#12 x 3	1000	
HAA04024BPK	#14 x 3/4	4000	
HAA04032BPK	#14 x 1	2500	
HAA04040BPK	#14 x 1 1/4	2000	
HAA04048BPK	#14 x 1 1/2	2000	
HAA04056BPK	#14 x 1 3/4	2000	
HAA04064BPK	#14 x 2	2000	
HAA04080BPK	#14 x 2 1/2	1200	
HAA04096BPK	#14 x 3	1500	
HAA04128BPK	#14 x 4	500	
HAA04160BPK	#14 x 5	500	
HAA04192BPK	#14 x 6	500	

### #3 POINT DRILL SCREW

ZINC PLATED

Line: 239-00



PART NUMBER	SIZE	QTY/BX	LIST PRICE
HAA03016	#10 x 1/2	100	
HAA03020	#10 x 5/8	100	
HAA03024	#10 x 3/4	100	
HAA03024C5	#10 x 3/4	500	
HAA03032	#10 x 1	100	
HAA03040X	#10 x 1 1/4	100	
HAA03048	#10 x 1 1/2	100	
HAA03056	#10 x 1 3/4	100	
HAA03064	#10 x 2	100	
HAA21024	#12 x 3/4	100	
HAA21032	#12 x 1	100	
HAA21040	#12 x 1 1/4	100	
HAA21048	#12 x 1 1/2	100	
HAA21056	#12 x 1 3/4	50	
HAA21064	#12 x 2	50	
HAA21080	#12 x 2 1/2	50	
HAA21096	#12 x 3	50	
HAA12240284	#12-24 x 7/8 (#4pt.)	100	
HAA12240404	#12-24 x 1 1/4 (#4pt.)	100	
HAA12240405	#12-24 x 1 1/4 (#5pt.)	100	
HAA12240485	#12-24 x 1 1/2 (#5pt.)	100	
HAA12240645	#12-24 x 2 (#5pt.)	100	
HAA12240804	#12-24 x 2 1/2 (#4pt.)	100	
HAA04024	#14 x 3/4	100	
HAA04024C5	#14 x 3/4	500	
HAA04032	#14 x 1	100	
HAA04040	#14 x 1 1/4	100	
HAA04040C5	#14 x 1 1/4	500	
HAA04048	#14 x 1 1/2	100	
HAA04056	#14 x 1 3/4	100	
HAA04064	#14 x 2	50	
HAA04080	#14 x 2 1/2	50	
HAA04096	#14 x 3	50	
HAA04128	#14 x 4	50	
HAA04160	#14 x 5	50	
HAA04192	#14 x 6	50	
HAA05032	5/16 x 1 (7/16 AF)	100	

### #3 POINT DRILL SCREW

SELF DRILL SCREW - 410 STAINLESS STEEL

Line: 239-01



PART NUMBER	SIZE	QTY/BX	LIST PRICE
ARZ03016	#10-16 x 1/2	100	
ARZ03020	#10-16 x 5/8	100	
ARZ03024	#10-16 x 3/4	100	
ARZ03032	#10-16 x 1	100	
ARZ03040	#10-16 x 1 1/4	100	
ARZ03048	#10-16 x 1 1/2	100	
ARZ04024	#14-14 x 3/4	100	
ARZ04032	#14-14 x 1	100	
ARZ04040	#14-14 x 1 1/4	100	
ARZ04048	#14-14 x 1 1/2	100	
ARZ04064	#14-14 x 2	100	
ARZ04080	#14-14 x 2 1/2	100	
ARZ04096	#14-14 x 3	50	

### PK HEX WASHER #3 PT DRIL-KWICK SCREW

ZINC PLATED

Line: 239-02



PART NUMBER	SIZE	QTY/BX	LIST PRICE
BZN88020	#8 x 5/8	100	
BZN03020	#10 x 5/8	100	
BZN03024	#10 x 3/4	100	
BZN03032	#10 x 1	100	
BZN03040	#10 x 1 1/4	100	
BZN03048	#10 x 1 1/2	100	
BZN03064	#10 x 2	100	
BZN21024	#12 x 3/4	100	
BZN21032	#12 x 1	100	
BZN21040	#12 x 1 1/4	100	
BZN21048	#12 x 1 1/2	100	
BZN21064	#12 x 2	50	
BZN04024	#14 x 3/4	100	
BZN04032	#14 x 1	100	
BZN04040	#14 x 1 1/4	100	
BZN04048	#14 x 1 1/2	100	
BZN04064	#14 x 2	50	
BZN04080	#14 x 2 1/2	50	
BZN04096	#14 x 3	50	
BZN04128	#14 x 4	50	

### PK HEX WASH LONG PT #4#5 DRIL-KWICK SCREW

SELF-DRILL SCREW

Line: 239-03



PART NUMBER	SIZE	QTY/BX	LIST PRICE
BZP21028	#12-24 x 7/8 (#4pt.)	100	
BZP21040	#12-24 x 1 1/4 (#4pt.)	100	
BZP21040-5	#12-24 x 1 1/4 (#5pt.)	100	
BZP21048	#12-24 x 1 1/2 (#4pt.)	100	
BZP21048-5	#12-24 x 1 1/2 (#5pt.)	100	
BZP21064-5	#12-24 x 2 (#5pt.)	100	

### PK HEX WASH LONG PT #4#5 DRIL-KWICK SCREW

SELF-DRILL SCREW ZINC PLATED - DOMESTIC

Line: 239-10

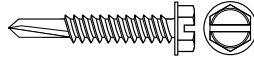

PART NUMBER	SIZE	QTY/BX	LIST PRICE
BZR03024	#10-24 x 3/4	100	
BZR03032	#10-24 x 1	100	
BZR03040	#10-24 x 1 1/4	100	
BZR03048	#10-24 x 1 1/2	100	

### PK PH/FLAT WOOD TO STEEL DRIL-KWICK SCREW

SELF-DRILL SCREW - DOMESTIC

Line: 239-11

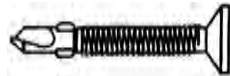

PART NUMBER	SIZE	QTY/BX	LIST PRICE
BZT03046	#10-24 x 1 7/16 (#3pt.)	100	
BZT21052	#12-24 x 1 5/8 (#4pt.)	100	
BZT21064	#12-24 x 2 (#4pt.)	100	
BZT21080	#12-24 x 2 1/2 (#4pt.)	100	
BZT04088	1/4-20 x 2 3/4 (#4pt.)	100	

### PK PHIP/PAN #2PT DRIL-KWICK SCREW

SELF-DRILL SCREW - ZINC PLATED

Line: 239-12

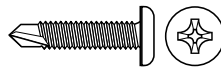

PART NUMBER	SIZE	QTY/BX	LIST PRICE
BZV66012	#6 x 3/8	100	
BZV66016	#6 x 1/2	100	
BZV66024	#6 x 3/4	100	
BZV88016	#8 x 1/2	100	
BZV88024	#8 x 3/4	100	
BZV03016	#10 x 1/2	100	
BZV03024	#10 x 3/4	100	
BZV03032	#10 x 1	100	

### PHIL PAN HEAD #2 POINT DRILL SCREW

SELF-DRILL SCREW - 410 STAINLESS STEEL

Line: 239-50

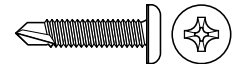

PART NUMBER	SIZE	QTY/BX	LIST PRICE
BSD66012	#6 x 3/8	100	
BSD66016	#6 x 1/2	100	
BSD66020	#6 x 5/8	100	
BSD66024	#6 x 3/4	100	
BSD66032	#6 x 1	100	
BSD88016	#8 x 1/2	100	
BSD88024	#8 x 3/4	100	
BSD88032	#8 x 1	100	
BSD88040	#8 x 1 1/4	100	
BSD88048	#8 x 1 1/2	100	
BSD03016	#10 x 1/2	100	
BSD03024	#10 x 3/4	100	
BSD03032	#10 x 1	100	
BSD03040	#10 x 1 1/4	100	
BSD03048	#10 x 1 1/2	100	
BSD21024	#12 x 3/4	100	
BSD21032	#12 x 1	100	
BSD21040	#12 x 1 1/4	100	
BSD21048	#12 x 1 1/2	100	
BSD04032	#14 x 1	100	
BSD04040	#14 x 1 1/4	100	
BSD04048	#14 x 1 1/2	100	
BSD04064	#14 x 2	100	

# METAL TO WOOD CONSTRUCTION SCREW

WITH COLORED HEADS

Line: 239-75

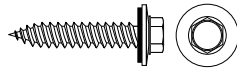

# PHILLIPS FLAT HEAD SELF DRILL SCREW

ZINC PLATED

Line: 239-84

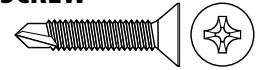

PART NUMBER	SIZE	QTY/BX	LIST PRICE
CDE99048T	#9-16 x 1 1/2 TAN	200	
CDE99032BR	#9-16 x 1 BROWN	200	
CDE99032DG	#9-16 x 1 DRK-GRAY	200	
CDE99032G	#9-16 x 1 GREEN	200	
CDE99032LG	#9-16 x 1 LIT-GRAY	200	
CDE99032R	#9-16 x 1 RED	200	
CDE99032T	#9-16 x 1 TAN	200	
CDE99032W	#9-16 x 1 WHITE	200	
CDE99032Z	#9-16 x 1 ZINC	200	
CDE99048BLU	#9-16 x 1 1/2 BLUE	200	
CDE99048BR	#9-16 x 1 1/2 BROWN	200	
CDE99048DG	#9-16 x 1 1/2 DK-GRAY	200	
CDE99048G	#9-16 x 1 1/2 GREEN	200	
CDE99048LG	#9-16 x 1 1/2 LT-GRAY	200	
CDE99048R	#9-16 x 1 1/2 RED	200	
CDE99048STN	#9-16 x 1 1/2 STONE	200	
CDE99048W	#9-16 x 1 1/2 WHITE	200	
CDE99048Z	#9-16 x 1 1/2 ZINC	200	
CDE99064BR	#9-16 x 2 BROWN	200	
CDE99064DG	#9-16 x 2 DK-GRAY	200	
CDE99064G	#9-16 x 2 GREEN	200	
CDE99064LG	#9-16 x 2 LIT-GRAY	200	
CDE99064R	#9-16 x 2 RED	200	
CDE99064T	#9-16 x 2 TAN	200	
CDE99064W	#9-16 x 2 WHITE	200	
CDE99064Z	#9-16 x 2 ZINC	200	
CDE99080BR	#9-16 x 2 1/2 BROWN	100	
CDE99080DG	#9-16 x 2 1/2 DK-GRAY	100	
CDE99080G	#9-16 x 2 1/2 GREEN	100	
CDE99080LG	#9-16 x 2 1/2 LT-GRAY	100	
CDE99080R	#9-16 x 2 1/2 RED	100	
CDE99080T	#9-16 x 2 1/2 TAN	100	
CDE99080W	#9-16 x 2 1/2 WHITE	100	
CDE99080Z	#9-16 x 2 1/2 ZINC	100	
CDE99096BR	#9-16 x 3 BROWN	100	
CDE99096DG	#9-16 x 3 DK-GRAY	100	
CDE99096G	#9-16 x 3 GREEN	100	
CDE99096LG	#9-16 x 3 LIT-GRAY	100	
CDE99096R	#9-16 x 3 RED	100	
CDE99096T	#9-16 x 3 TAN	100	
CDE99096W	#9-16 x 3 WHITE	100	
CDE99096Z	#9-16 x 3 ZINC	100	
CDE99032STN	9/16 x 1 STONE	200	

PART NUMBER	SIZE	QTY/BX	LIST PRICE
CHD66012	6 X 3/8 #2 PT	100	
CHD66016	6 X 1/2 #2 PT	100	
CHD66020	6 X 5/8 #2 PT	100	
CHD66024	6 X 3/4 #2 PT	100	
CHD66032	6 X 1 #2 PT	100	
CHD66040	6 X 1 1/4 #2 PT	100	
CHD66048	6 X 1 1/2 #2 PT	100	
CHD88012	8 X 3/8 #2PT	100	
CHD88016	8 X 1/2 #2PT	100	
CHD88020	8 X 5/8 #2PT	100	
CHD88024	8 X 3/4 #2PT	100	
CHD88032	8 X 1 #2 PT	100	
CHD88040	8 X 1 1/4 #2 PT	100	
CHD88048	8 X 1 1/2 #2 PT	100	
CHD88064	8 X 2 #2 PT	100	
CHD88080	8 X 2 1/2 #2 PT	50	
CHD03016	10 X 1/2 #2 PT	100	
CHD03020	10 X 5/8 #3 PT	100	
CHD03024	10 X 3/4 #3 PT	100	
CHD03032	10 X 1 #3 PT	100	
CHD03040	10 X 1 1/4 #3 PT	100	
CHD03048	10 X 1 1/2 #3 PT	100	
CHD03064	10 X 2 #3 PT	100	
CHD03080	10 X 2 1/2 #3 PT	100	
CHD03096	10 X 3 #2 PT	50	
CHD21024	12 X 3/4 #3 PT	100	
CHD21032	12 X 1 #3 PT	100	
CHD21040	12 X 1 1/4 #3 PT	100	
CHD21048	12 X 1 1/2 #3 PT	100	
CHD21064	12 X 2 #3 PT	50	
CHD04024	14 X 3/4 #2 PT	100	
CHD04032	14 X 1 #3 PT	100	
CHD04040	14 X 1 1/4 #3 PT	100	
CHD04048	14 X 1 1/2 #3 PT	100	
CHD04064	14 X 2 #3 PT	50	
CHD04080	14 X 2 1/2 #3 PT	50	
CHD04096	14 X 3 #3 PT	50	



## PHILLIPS PAN HEAD #2 POINT DRILL SCREW

ZINC PLATED

Line: 240-00

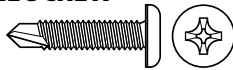

PART NUMBER	SIZE	QTY/BX	LIST PRICE
HBA66012	#6 x 3/8	100	
HBA66014BLKM	#6 x 7/16 (Blk. Framing Screw)	1000	
HBA66014BLK	#6 x 7/16 (Blk. Framing Screw)	100	
HBA66014BLKSP	#6 x 7/16 (Blk. Sharp Point)	100	
HBA66014ZDP	#6 x 7/16 (Framing Screw)	100	
HBA66016	#6 x 1/2	100	
HBA66020	#6 x 5/8	100	
HBA66024	#6 x 3/4	100	
HBA66032	#6 x 1	100	
HBA66040	#6 x 1 1/4	100	
HBA66048	#6 x 1 1/2	100	
HBA88012	#8 x 3/8	100	
HBA88016	#8 x 1/2	100	
HBA88016C5	#8 x 1/2	500	
HBA88020	#8 x 5/8	100	
HBA88024	#8 x 3/4	100	
HBA88032	#8 x 1	100	
HBA88040	#8 x 1 1/4	100	
HBA88048	#8 x 1 1/2	100	
HBA88064	#8 x 2	100	
HBA03016	#10 x 1/2	100	
HBA03020	#10 x 5/8	100	
HBA03024	#10 x 3/4	100	
HBA03032	#10 x 1	100	
HBA03040	#10 x 1 1/4	100	
HBA03048	#10 x 1 1/2	100	
HBA03064	#10 x 2	100	

## WOOD TO METAL S/DRILL SCREW

ZINC PLATED

Line: 240-01

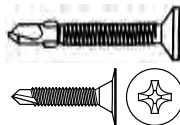

PART NUMBER	SIZE	QTY/BX	LIST PRICE
JPD88032	#8-18 x 1	100	
JPD03024	#10-24 x 3/4	100	
JPD03032	#10-24 x 1	100	
JPD03040	#10-24 x 1 1/4	100	
JPD03048	#10-24 x 1 1/2	100	
JPD03046	#10-24 x 1 7/16 (Flt. Hd. w/Wings)	100	
JPD21064	#12-24 x 2 (Flt. Hd. w/Wings)	100	
JPD21072	#12-24 x 2 1/4 (Flt. Hd. w/Wings)	100	
JPD21080	#12-24 x 2 1/2 (Flt. Hd. w/Wings)	100	
JPD04112	1/4-20 x 3 1/2 (Flt. Hd. w/Wings)	100	
JPD04088	1/4-20 x 2 3/4 (Flt. Hd. w/Wings)	100	
JPD04104	1/4-20 x 3 1/4 (Flt. Hd. w/Wings)	100	
JPD04120	1/4-20 x 3 3/4 (Flt. Hd. w/Wings)	100	

## PHILLIPS BUGLE HEAD DRYWALL SCREW

FINE THREAD

Line: 240-02



PART NUMBER	SIZE	QTY/BX	LIST PRICE
AWB66024C	#6 x 3/4	100	
AWB66032	#6 x 1	500	
AWB66032C	#6 x 1	100	
AWB66032M	#6 x 1	1000	
AWB66032#1	#6 x 1 (1 lb. box)	1	
AWB66032#5	#6 x 1 (5 lb. box)	5	
AWB66036	#6 x 1 1/8	500	
AWB66036C	#6 x 1 1/8	100	
AWB66036M	#6 x 1 1/8	1000	
AWB66040	#6 x 1 1/4	500	
AWB66040C	#6 x 1 1/4	100	
AWB66040M	#6 x 1 1/4	1000	
AWB66040#1	#6 x 1 1/4 (1 lb. box)	1	
AWB66040#5	#6 x 1 1/4 (5 lb. box)	5	
AWB66052	#6 x 1 5/8	500	
AWB66052C	#6 x 1 5/8	100	
AWB66052M	#6 x 1 5/8	1000	
AWB66052#1	#6 x 1 5/8 (1 lb. box)	1	
AWB66052#5	#6 x 1 5/8 (5 lb. box)	5	
AWB66064	#6 x 2	200	
AWB66064C	#6 x 2	100	
AWB66064C5	#6 x 2	500	
AWB66064M	#6 x 2	1000	
AWB66064#1	#6 x 2 (1 lb. box)	1	
AWB66064#5	#6 x 2 (5 lb. box)	5	
AWB66072	#6 x 2 1/4	200	
AWB66072C	#6 x 2 1/4	100	
AWB66072C5	#6 x 2 1/4	500	
AWB66072M	#6 x 2 1/4	1000	
AWB66072#1	#6 x 2 1/4 (1 lb. box)	1	
AWB66072#5	#6 x 2 1/4 (5 lb. box)	5	
AWB77080	#7 x 2 1/2	200	
AWB77080C	#7 x 2 1/2	100	
AWB77080C5	#7 x 2 1/2	500	
AWB77080M	#7 x 2 1/2	1000	
AWB88080	#8 x 2 1/2	200	
AWB88080C	#8 x 2 1/2	100	
AWB88080C5	#8 x 2 1/2	500	
AWB88080M	#8 x 2 1/2	1000	
AWB88080#1	#8 x 2 1/2 (1 lb. box)	1	
AWB88080#5	#8 x 2 1/2 (5 lb. box)	5	
AWB88096	#8 x 3	200	
AWB88096C	#8 x 3	100	
AWB88096C250	#8 x 3	250	

(continued...)

**PHILLIPS BUGLE HEAD DRYWALL SCREW (cont.)**

FINE THREAD

Line: 240-02

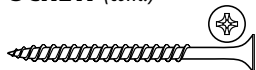

PART NUMBER	SIZE	QTY/BX	LIST PRICE
AWB88096M	#8 x 3	1000	
AWB88096#1	#8 x 3 (1 lb. box)	1	
AWB88096#5	#8 x 3 (5 lb. box)	5	
AWB03112	#10 x 3 1/2	100	
AWB03112#1	#10 x 3 1/2 (1 lb. box)	1	
AWB03112#5	#10 x 3 1/2 (5 lb. box)	5	
AWB03120	#10 x 3 3/4	100	
AWB03128	#10 x 4	100	
AWB03128C150	#10 x 4	150	
AWB03128M	#10 x 4	1000	
AWB03128#1	#10 x 4 (1 lb. box)	1	
AWB03128#5	#10 x 4 (5 lb. box)	5	
AWB03144	#10 x 4 1/2	100	
AWB03160	#10 x 5	100	
AWB03192	#10 x 6	100	

**PHILLIPS BUGLE HEAD DRYWALL SCREW**

COURSE THREAD

Line: 240-03

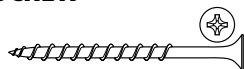

PART NUMBER	SIZE	QTY/BX	LIST PRICE
ABX66032	#6 x 1	500	
ABX66032C	#6 x 1	100	
ABX66032M	#6 x 1	1000	
ABX66032#1	#6 x 1 (1 lb. box)	1	
ABX66032#5	#6 x 1 (5 lb. box)	5	
ABX66036	#6 x 1 1/8	500	
ABX66036C	#6 x 1 1/8	100	
ABX66036M	#6 x 1 1/8	1000	
ABX66036YZ	#6 x 1 1/8 (Zinc/Yellow)	500	
ABX66040	#6 x 1 1/4	500	
ABX66040C	#6 x 1 1/4	100	
ABX66040M	#6 x 1 1/4	1000	
ABX66040#1	#6 x 1 1/4 (1 lb. box)	1	
ABX66040#5	#6 x 1 1/4 (5 lb. box)	5	
ABX66052	#6 x 1 5/8	500	
ABX66052C	#6 x 1 5/8	100	
ABX66052M	#6 x 1 5/8	1000	
ABX66052#1	#6 x 1 5/8 (1 lb. box)	1	
ABX66052#5	#6 x 1 5/8 (5 lb. box)	5	
ABX66064	#6 x 2	200	
ABX66064C	#6 x 2	100	
ABX66064M	#6 x 2	1000	
ABX66064C5	#6 x 2	500	
ABX66064#1	#6 x 2 (1 lb. box)	1	

**PHILLIPS BUGLE HEAD DRYWALL SCREW (cont.)**

COURSE THREAD

Line: 240-03

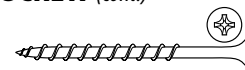

PART NUMBER	SIZE	QTY/BX	LIST PRICE
ABX66064#5	#6 x 2 (5 lb. box)	5	
ABX66072	#6 x 2 1/4	200	
ABX66072C	#6 x 2 1/4	100	
ABX66072C5	#6 x 2 1/4	500	
ABX66072M	#6 x 2 1/4	1000	
ABX66072#5	#6 x 2 1/4 (5 lb. box)	5	
ABX77080	#7 x 2 1/2	200	
ABX77080C	#7 x 2 1/2	100	
ABX77080C5	#7 x 2 1/2	500	
ABX77080M	#7 x 2 1/2	1000	
ABX88080	#8 x 2 1/2	200	
ABX88080C	#8 x 2 1/2	100	
ABX88080C5	#8 x 2 1/2	500	
ABX88080M	#8 x 2 1/2	1000	
ABX88080#1	#8 x 2 1/2 (1 lb. box)	1	
ABX88080#5	#8 x 2 1/2 (5 lb. box)	5	
ABX88096	#8 x 3	200	
ABX88096C	#8 x 3	100	
ABX88096C250	#8 x 3	250	
ABX88096M	#8 x 3	1000	
ABX88096#1	#8 x 3 (1 lb. box)	1	
ABX88096#5	#8 x 3 (5 lb. box)	5	
ABX03112C150	#10 x 3 1/2	150	
ABX03112#1	#10 x 3 1/2 (1 lb. box)	1	
ABX03112#5	#10 x 3 1/2 (5 lb. box)	5	
ABX03128C150	#10 x 4	150	
ABX03128#1	#10 x 4 (1 lb. box)	1	
ABX03128#5	#10 x 4 (5 lb. box)	5	



**CALL - 1 (800) 723-2826**

## PHILLIPS BUGLE HEAD SCREW TEK POINT

COURSE THREAD

Line: 240-04

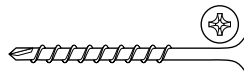

PART NUMBER	SIZE	QTY/BX	LIST PRICE
ABY66032	#6 x 1	500	
ABY66032C	#6 x 1	100	
ABY66032M	#6 x 1	1000	
ABY66040	#6 x 1 1/4	500	
ABY66040C	#6 x 1 1/4	100	
ABY66040M	#6 x 1 1/4	1000	
ABY66040#5	#6 x 1 1/4 (5 lb. box)	5	
ABY66040ZP	#6 x 1 1/4 (Zinc Plated)	500	
ABY66052	#6 x 1 5/8	500	
ABY66052C	#6 x 1 5/8	100	
ABY66052M	#6 x 1 5/8	1000	
ABY66052#5	#6 x 1 5/8 (5 lb. box)	5	
ABY66060	#6 x 1 7/8	500	
ABY66060C	#6 x 1 7/8	100	
ABY66060M	#6 x 1 7/8	1000	
ABY66060#5	#6 x 1 7/8 (5 lb. box)	5	
ABY88076	#8 x 2 3/8	200	
ABY88076C	#8 x 2 3/8	100	
ABY88076M	#8 x 2 3/8	1000	
ABY88076ZP	#8 x 2 3/8 (Zinc Plated)	100	
ABY88084	#8 x 2 5/8	200	
ABY88084C	#8 x 2 5/8	100	
ABY88084M	#8 x 2 5/8	1000	
ABY88084#5	#8 x 2 5/8 (5 lb. box)	5	
ABY88096	#8 x 3	200	
ABY88096C	#8 x 3	100	
ABY88096M	#8 x 3	1000	
ABY88096#5	#8 x 3 (5 lb. box)	5	
ABY88096Z	#8 x 3 (Zinc Plated)	2000	

## PHILLIPS BUGLE HEAD SCREW

HI-LOW THREAD

Line: 240-05



PART NUMBER	SIZE	QTY/BX	LIST PRICE
ABZ66032	#6 x 1	500	
ABZ66032C	#6 x 1	100	
ABZ66032M	#6 x 1	1000	
ABZ66036	#6 x 1 1/8	500	
ABZ66036C	#6 x 1 1/8	100	
ABZ66036M	#6 x 1 1/8	1000	
ABZ66040	#6 x 1 1/4	500	
ABZ66040C	#6 x 1 1/4	100	
ABZ66040M	#6 x 1 1/4	1000	
ABZ66052	#6 x 1 5/8	500	

(continued...)

## PHILLIPS BUGLE HEAD SCREW (cont.)

HI-LOW THREAD

Line: 240-05

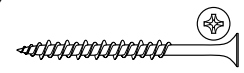

PART NUMBER	SIZE	QTY/BX	LIST PRICE
ABZ66052C	#6 x 1 5/8	100	
ABZ66052M	#6 x 1 5/8	1000	
ABZ66064	#6 x 2	200	
ABZ66064C	#6 x 2	100	
ABZ66064M	#6 x 2	1000	
ABZ66072	#6 x 2 1/4	200	
ABZ66072C	#6 x 2 1/4	100	
ABZ66072M	#6 x 2 1/4	1000	
ABZ88080	#8 x 2 1/2	200	
ABZ88080C	#8 x 2 1/2	100	
ABZ88080M	#8 x 2 1/2	1000	
ABZ88096	#8 x 3	200	
ABZ88096C	#8 x 3	100	
ABZ88096M	#8 x 3	1000	

## PHILLIPS BUGLE HEAD DECKING SCREW

DACRO COAT

Line: 240-06

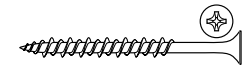

PART NUMBER	SIZE	QTY/BX	LIST PRICE
ATL66032C	#6 x 1	100	
ATL66032	#6 x 1	500	
ATL66032M	#6 x 1	1000	
ATL66032#1	#6 x 1 (1 lb. box)	1	
ATL66032#5	#6 x 1 (5 lb. box)	5	
ATL66036	#6 x 1 1/8	500	
ATL66036C	#6 x 1 1/8	100	
ATL66036#1	#6 x 1 1/8 (1 lb. box)	1	
ATL66040	#6 x 1 1/4	500	
ATL66040C	#6 x 1 1/4	100	
ATL66040M	#6 x 1 1/4	1000	
ATL66040#1	#6 x 1 1/4 (1 lb. box)	1	
ATL66040#5	#6 x 1 1/4 (5 lb. box)	5	
ATL66052	#6 x 1 5/8	500	
ATL66052C	#6 x 1 5/8	100	
ATL66052M	#6 x 1 5/8	1000	
ATL66052#1	#6 x 1 5/8 (1 lb. box)	1	
ATL66052#5	#6 x 1 5/8 (5 lb. box)	5	
ATL66064C	#6 x 2	100	
ATL66064	#6 x 2	200	
ATL66064C5	#6 x 2	500	
ATL66064M	#6 x 2	1000	
ATL66064#1	#6 x 2 (1 lb. box)	1	
ATL66064#5	#6 x 2 (5 lb. box)	5	
ATL66072	#6 x 2 1/4	200	

(continued...)

## PHILLIPS BUGLE HEAD DECKING SCREW (cont.)

DACRO COAT

Line: 240-06

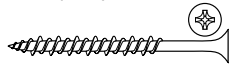

PART NUMBER	SIZE	QTY/BX	LIST PRICE
ATL66072C	#6 x 2 1/4	100	
ATL66072M	#6 x 2 1/4	1000	
ATL66072#1	#6 x 2 1/4 (1 lb. box)	1	
ATL77080	#7 x 2 1/2	200	
ATL77080C	#7 x 2 1/2	100	
ATL77080M	#7 x 2 1/2	1000	
ATL88080	#8 x 2 1/2	200	
ATL88080C	#8 x 2 1/2	100	
ATL88080C5	#8 x 2 1/2	500	
ATL88080M	#8 x 2 1/2	1000	
ATL88080#1	#8 x 2 1/2 (1 lb. box)	1	
ATL88080#5	#8 x 2 1/2 (5 lb. box)	5	
ATL88096C	#8 x 3	100	
ATL88096	#8 x 3	200	
ATL88096C250	#8 x 3	250	
ATL88096C5	#8 x 3	500	
ATL88096M	#8 x 3	1000	
ATL88096#1	#8 x 3 (1 lb. box)	1	
ATL88096#5	#8 x 3 (5 lb. box)	5	
ATL03112	#10 x 3 1/2	100	
ATL03112#1	#10 x 3 1/2 (1 lb. box)	1	
ATL03112#5	#10 x 3 1/2 (5 lb. box)	5	
ATL03128	#10 x 4	100	
ATL03128C150	#10 x 4	150	
ATL03128#1	#10 x 4 (1 lb. box)	1	
ATL03128#5	#10 x 4 (5 lb. box)	5	
ATL03144#1	#10 x 4 1/2 (1 lb. box)	1	

## TRIM HEAD DRYWALL SCREW

SQUARE AND PHILLIPS TRIM HEAD

Line: 240-07

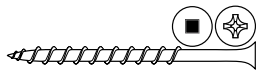

PART NUMBER	SIZE	QTY/BX	LIST PRICE
BBR66052PHC	#6 x 1 5/8 (Phillips Drive)	100	
BBR66052DP	#6 x 1 5/8 (Square Drive S/Drill)	200	
BBR66052	#6 x 1 5/8 (Square Drive)	200	
BBR66072PHC	#6 x 2 1/4 (Phillips Drive)	100	
BBR66072DP	#6 x 2 1/4 (Square Drive S/Drill)	200	
BBR66072	#6 x 2 1/4 (Square Drive)	200	
BBR88096DP	#8 x 3 (Square Drive S/Drill)	200	
BBR88096	#8 x 3 (Square Drive)	100	

## SQUARE DRIVE BUGLE HEAD DECK SCREW

STAINLESS STEEL

Line: 240-08

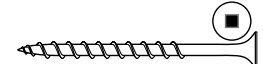

PART NUMBER	SIZE	QTY/BX	LIST PRICE
CAX88032C5	#8 x 1	500	
CAX88040C5	#8 x 1 1/4	500	
CAX88052	#8 x 1 5/8	100	
CAX88064	#8 x 2	100	
CAX88080	#8 x 2 1/2	200	
CAX88096	#8 x 3	200	
CAX03080	#10 x 2 1/2	100	
CAX03096	#10 x 3	100	
CAX03112	#10 x 3 1/2	100	

## PHILLIPS BUGLE HEAD DECK SCREW

STAINLESS STEEL

Line: 240-09

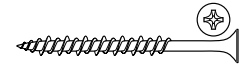

PART NUMBER	SIZE	QTY/BX	LIST PRICE
ATL66040SS	#6 x 1 1/4	100	
ATL88052SS	#8 x 1 5/8	100	
ATL88064SS	#8 x 2	100	
ATL88080SS	#8 x 2 1/2	100	
ATL88096SS	#8 x 3	100	
ATL03080SS	#10 x 2 1/2	100	
ATL03096SS	#10 x 3	100	
ATL03112SS	#10 x 3 1/2	100	

## COMBO DRIVE SUPER WOODIE AUGER PT

HARDENED STEEL

Line: 240-10



PART NUMBER	SIZE	QTY/BX	LIST PRICE
AUB88032	#8 x 1	200	
AUB88040	#8 x 1 1/4	200	
AUB88048	#8 x 1 1/2	200	
AUB88052	#8 x 1 5/8	200	
AUB88064	#8 x 2	200	
AUB99080	#9 x 2 1/2	200	
AUB99096	#9 x 3	200	



CALL - 1 (800) 723-2826

## PHILLIPS DRIVE STANDARD POINT WOODIE

HARDENED STEEL

Line: 240-11



PART NUMBER	SIZE	QTY/BX	LIST PRICE
AUD88024	#8 x 3/4	200	
AUD88032	#8 x 1	200	
AUD88040	#8 x 1 1/4	200	
AUD88048	#8 x 1 1/2	200	
AUD88064	#8 x 2	200	
AUD88072WHT	#8 x 2 1/4 (White Hd.)	3000	
AUD99080	#9 x 2 1/2	200	
AUD99096	#9 x 3	200	

## SQUARE DRIVE STANDARD POINT WOODIE

HARDENED STEEL

Line: 240-12



PART NUMBER	SIZE	QTY/BX	LIST PRICE
AUE88024	#8 x 3/4	200	
AUE88032	#8 x 1	200	
AUE88040	#8 x 1 1/4	200	
AUE88048	#8 x 1 1/2	200	
AUE88064	#8 x 2	200	
AUE88080ZBPK	#8 x 2 1/2 (Zinc Plated)	2500	
AUE99080	#9 x 2 1/2	200	
AUE99096	#9 x 3	200	
AUE03128	#10 x 4 (Auger Pt.)	100	
AUE03192	#10 x 6 (Auger Pt.)	100	

## SQUARE DRIVE WOODIE ALL WEATHER DECKING

Line: 240-13



PART NUMBER	SIZE	QTY/BX	LIST PRICE
AUH77040	#7 x 1 1/4 (Auger Pt.)	200	
AUH88044	#8 x 1 3/8 (Auger Pt.)	200	
AUH88048	#8 x 1 1/2	200	
AUH88052	#8 x 1 5/8 (Auger Pt.)	200	
AUH88064	#8 x 2	100	
AUH99064	#9 x 2 (Auger Pt.)	100	
AUH99080	#9 x 2 1/2 (Auger Pt.)	100	
AUH99096	#9 x 3 (Auger Pt.)	100	
AUH03128	#10 x 4 (Auger Pt.)	100	
AUH03160	#10 x 5 (Auger Pt.)	100	
AUH03192	#10 x 6 (Auger Pt.)	100	

## PHILLIPS ROUND WASH LATH SCREW

DRILL POINT - ZINC PLATED

Line: 240-15

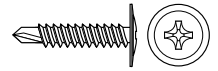

PART NUMBER	SIZE	QTY/BX	LIST PRICE
CCN88016ZP	#8 x 1/2	100	
CCN88016BK	#8 x 1/2 (Black)	100	
CCN88024ZP	#8 x 3/4	100	
CCN88024ZPM	#8 x 3/4	1000	
CCN88024BK	#8 x 3/4 (Black)	100	
CCN88032ZP	#8 x 1	100	
CCN88032ZPM	#8 x 1	1000	
CCN88032BK	#8 x 1 (Black)	100	
CCN88040ZP	#8 x 1 1/4	100	
CCN88040ZPM	#8 x 1 1/4	1000	
CCN88040BK	#8 x 1 1/4 (Black)	100	
CCN88052ZP	#8-18 x 1 5/8	100	

## PHILLIPS ROUND WASH LATH SCREW

NEEDLE POINT - ZINC PLATED

Line: 240-16

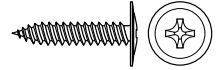

PART NUMBER	SIZE	QTY/BX	LIST PRICE
CBT88016Z	#8 x 1/2	200	
CBT88018	#8 x 9/16 (Black)	200	
CBT88018Z	#8 x 9/16	200	
CBT88024	#8 x 3/4 (Black)	200	
CBT88024Z	#8 x 3/4	200	
CBT88032	#8 x 1 (Black)	200	
CBT88032Z	#8 x 1	200	
CBT88052	#8 x 1 5/8 (Black)	200	
CBT88052Z	#8 x 1 5/8	200	
CBT88040	#8 x 1 1/4 (Black)	200	
CBT88040Z	#8 x 1 1/4	200	

## SQUARE DRIVE BUGLE HEAD DECKING

DACRO COAT

Line: 240-23



PART NUMBER	SIZE	QTY/BX	LIST PRICE
CCZ66040	#6 x 1 1/4	500	
CCZ66040BPK	#6 x 1 1/4	8000	
CCZ66040C	#6 x 1 1/4	100	
CCZ66040M	#6 x 1 1/4	1000	
CCZ66052	#6 x 1 5/8	500	
CCZ66052BPK	#6 x 1 5/8	5000	
CCZ66052C	#6 x 1 5/8	100	
CCZ66052M	#6 x 1 5/8	1000	
CCZ66064	#6 x 2	200	
CCZ66064C	#6 x 2	100	
CCZ66064C5	#6 x 2	500	
CCZ66064M	#6 x 2	1000	
CCZ88080	#8 x 2 1/2	200	
CCZ88080BPK	#8 x 2 1/2	2500	
CCZ88080C	#8 x 2 1/2	100	
CCZ88080C5	#8 x 2 1/2	500	
CCZ88080M	#8 x 2 1/2	1000	
CCZ88096	#8 x 3	200	
CCZ88096BPK	#8 x 3	2000	
CCZ88096C	#8 x 3	100	
CCZ88096M	#8 x 3	1000	
CCZ03128Q150	#10 x 4	150	

## SQUARE DRIVE BUGLE HEAD DECK SCREW (cont.)

YELLOW ZINC

Line: 240-24

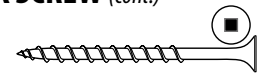

PART NUMBER	SIZE	QTY/BX	LIST PRICE
CCY88080BK#1	#8 x 2 1/2 (Black)	1 LB.	
CCY88096	#8 x 3	200	
CCY88096BPK	#8 x 3	2000	
CCY88096C	#8 x 3	100	
CCY88096M	#8 x 3	1000	

## PHILLIPS DRIVE BUGLE HEAD DECK SCREW

YELLOW ZINC

Line: 240-25

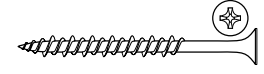

PART NUMBER	SIZE	QTY/BX	LIST PRICE
ATL66032YZ	#6 x 1	500	
ATL66032YZC	#6 x 1	100	
ATL66032YZM	#6 x 1	1000	
ATL66032YZ#1	#6 x 1 (1 lb. box)	1 LB.	
ATL66032YZ#5	#6 x 1 (5 lb. box)	5 LB.	
ATL66036YZ	#6 x 1 1/8	500	
ATL66036YZC	#6 x 1 1/8	100	
ATL66036YZM	#6 x 1 1/8	1000	
ATL66040YZ	#6 x 1 1/4	500	
ATL66040YZC	#6 x 1 1/4	100	
ATL66040YZM	#6 x 1 1/4	1000	
ATL66040YZ#1	#6 x 1 1/4 (1 lb. box)	1 LB.	
ATL66040YZ#5	#6 x 1 1/4 (5 lb. box)	5 LB.	
ATL66052YZ	#6 x 1 5/8	500	
ATL66052YZC	#6 x 1 5/8	100	
ATL66052YZM	#6 x 1 5/8	1000	
ATL66052YZ#1	#6 x 1 5/8 (1 lb. box)	1 LB.	
ATL66052YZ#5	#6 x 1 5/8 (5 lb. box)	5 LB.	
ATL66064YZ	#6 x 2	200	
ATL66064YZC	#6 x 2	100	
ATL66064YZC5	#6 x 2	500	
ATL66064YZM	#6 x 2	1000	
ATL66064YZ#1	#6 x 2 (1 lb. box)	1 LB.	
ATL66064YZ#5	#6 x 2 (5 lb. box)	5 LB.	
ATL66072YZ	#6 x 2 1/4	200	
ATL66072YZC	#6 x 2 1/4	100	
ATL66072YZM	#6 x 2 1/4	1000	
ATL88080YZ	#8 x 2 1/2	200	
ATL88080YZ#5	#8 x 2 1/2	5 LB.	
ATL88080YZC	#8 x 2 1/2	100	
ATL88080YZC5	#8 x 2 1/2	500	
ATL88080YZM	#8 x 2 1/2	1000	
ATL88080YZ#1	#8 x 2 1/2 (1 lb. box)	1 LB.	
ATL88096YEL	#8 x 3	200	
ATL88096YZ250	#8 x 3	250	

## SQUARE DRIVE BUGLE HEAD DECK SCREW

YELLOW ZINC

Line: 240-24

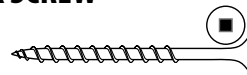

PART NUMBER	SIZE	QTY/BX	LIST PRICE
CCY66040	#6 x 1 1/4	500	
CCY66040BPK	#6 x 1 1/4	8000	
CCY66040C	#6 x 1 1/4	100	
CCY66040M	#6 x 1 1/4	1000	
CCY66052	#6 x 1 5/8	500	
CCY66052BPK	#6 x 1 5/8	5000	
CCY66052C	#6 x 1 5/8	100	
CCY66052M	#6 x 1 5/8	1000	
CCY66052BK#1	#6 x 1 5/8 (Black)	1 LB.	
CCY66052BK#5	#6 x 1 5/8 (Black)	5 LB.	
CCY66064	#6 x 2	200	
CCY66064BPK	#6 x 2	3500	
CCY66064C	#6 x 2	100	
CCY66064M	#6 x 2	1000	
CCY88080	#8 x 2 1/2	200	
CCY88080BPK	#8 x 2 1/2	2500	
CCY88080C	#8 x 2 1/2	100	
CCY88080M	#8 x 2 1/2	1000	

(continued...)

(continued...)

**PHILLIPS DRIVE BUGLE HEAD DECK SCREW (cont.)**

YELLOW ZINC

Line: 240-25

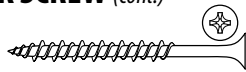

PART NUMBER	SIZE	QTY/BX	LIST PRICE
ATL88096YZC	#8 x 3	100	
ATL88096YZM	#8 x 3	1000	
ATL88096YZ#1	#8 x 3 (1 lb. box)	1 LB.	
ATL88096YZ#5	#8 x 3 (5 lb. box)	5 LB.	
ATL03112Y150	#10 x 3 1/2	150	
ATL03128Y150	#10 x 4	150	

**SLOTTED FLAT WOOD SCREW**

ZINC PLATED

Line: 241-00

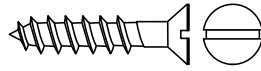

PART NUMBER	SIZE	QTY/BX	LIST PRICE
HDA00008	#0 x 1/4	100	
HDA00012	#0 x 3/8	100	
HDA11012	#1 x 3/8	100	
HDA11016	#1 x 1/2	100	
HDA22008	#2 x 1/4	100	
HDA22012	#2 x 3/8	100	
HDA22016	#2 x 1/2	100	
HDA22020X	#2 x 5/8	100	
HDA22024	#2 x 3/4	100	
HDA33008X	#3 x 1/4	100	
HDA33012	#3 x 3/8	100	
HDA33016	#3 x 1/2	100	
HDA33020	#3 x 5/8	100	
HDA33024	#3 x 3/4	100	
HDA33032	#3 x 1	100	
HDA44008	#4 x 1/4	100	
HDA44012	#4 x 3/8	100	
HDA44016	#4 x 1/2	100	
HDA44020	#4 x 5/8	100	
HDA44024	#4 x 3/4	100	
HDA44028	#4 x 7/8	100	
HDA44032	#4 x 1	100	
HDA44040	#4 x 1 1/4	100	
HDA44048	#4 x 1 1/2	100	
HDA55012X	#5 x 3/8	100	
HDA55016	#5 x 1/2	100	
HDA55020	#5 x 5/8	100	
HDA55024	#5 x 3/4	100	
HDA55028	#5 x 7/8	100	
HDA55032	#5 x 1	100	
HDA55040	#5 x 1 1/4	100	
HDA55048	#5 x 1 1/2	100	
HDA55056X	#5 x 1 3/4	100	

(continued...)

**SLOTTED FLAT WOOD SCREW (cont.)**

ZINC PLATED

Line: 241-00

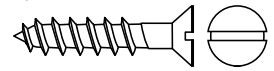

PART NUMBER	SIZE	QTY/BX	LIST PRICE
HDA55064	#5 x 2	100	
HDA66012	#6 x 3/8	100	
HDA66016	#6 x 1/2	100	
HDA66020	#6 x 5/8	100	
HDA66024	#6 x 3/4	100	
HDA66028	#6 x 7/8	100	
HDA66032	#6 x 1	100	
HDA66040	#6 x 1 1/4	100	
HDA66048	#6 x 1 1/2	100	
HDA66056	#6 x 1 3/4	100	
HDA66064	#6 x 2	100	
HDA66072	#6 x 2 1/4	100	
HDA66080	#6 x 2 1/2	100	
HDA77012	#7 x 3/8	100	
HDA77016	#7 x 1/2	100	
HDA77020	#7 x 5/8	100	
HDA77024	#7 x 3/4	100	
HDA77028	#7 x 7/8	100	
HDA77032	#7 x 1	100	
HDA77040	#7 x 1 1/4	100	
HDA77048	#7 x 1 1/2	100	
HDA77056	#7 x 1 3/4	100	
HDA77064	#7 x 2	100	
HDA77072X	#7 x 2 1/4	100	
HDA77080	#7 x 2 1/2	100	
HDA88012	#8 x 3/8	100	
HDA88016	#8 x 1/2	100	
HDA88020	#8 x 5/8	100	
HDA88024	#8 x 3/4	100	
HDA88028	#8 x 7/8	100	
HDA88032	#8 x 1	100	
HDA88036	#8 x 1 1/8	100	
HDA88040	#8 x 1 1/4	100	
HDA88048	#8 x 1 1/2	100	
HDA88056	#8 x 1 3/4	100	
HDA88064	#8 x 2	100	
HDA88072	#8 x 2 1/4	100	
HDA88080	#8 x 2 1/2	100	
HDA88088	#8 x 2 3/4	100	
HDA88096	#8 x 3	100	
HDA88112	#8 x 3 1/2	100	
HDA88128	#8 x 4	100	
HDA99016	#9 x 1/2	100	
HDA99020	#9 x 5/8	100	

(continued...)

**SLOTTED FLAT WOOD SCREW (cont.)**

ZINC PLATED

Line: 241-00

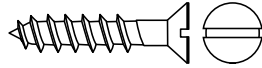

PART NUMBER	SIZE	QTY/BX	LIST PRICE
HDA99024	#9 x 3/4	100	
HDA99028	#9 x 7/8	100	
HDA99032	#9 x 1	100	
HDA99040	#9 x 1 1/4	100	
HDA99048	#9 x 1 1/2	100	
HDA99056	#9 x 1 3/4	100	
HDA99064	#9 x 2	100	
HDA99072X	#9 x 2 1/4	100	
HDA99080	#9 x 2 1/2	100	
HDA99088X	#9 x 2 3/4	100	
HDA99096	#9 x 3	100	
HDA99112X	#9 x 3 1/2	100	
HDA03016	#10 x 1/2	100	
HDA03020	#10 x 5/8	100	
HDA03024	#10 x 3/4	100	
HDA03028	#10 x 7/8	100	
HDA03032	#10 x 1	100	
HDA03040	#10 x 1 1/4	100	
HDA03048	#10 x 1 1/2	100	
HDA03056	#10 x 1 3/4	100	
HDA03064	#10 x 2	100	
HDA03072	#10 x 2 1/4	100	
HDA03080	#10 x 2 1/2	100	
HDA03088	#10 x 2 3/4	100	
HDA03096	#10 x 3	100	
HDA03112	#10 x 3 1/2	100	
HDA03128	#10 x 4	100	
HDA21016	#12 x 1/2	100	
HDA21020	#12 x 5/8	100	
HDA21024	#12 x 3/4	100	
HDA21028	#12 x 7/8	100	
HDA21032	#12 x 1	100	
HDA21040	#12 x 1 1/4	100	
HDA21048	#12 x 1 1/2	100	
HDA21056	#12 x 1 3/4	100	
HDA21064	#12 x 2	100	
HDA21072	#12 x 2 1/4	100	
HDA21080	#12 x 2 1/2	100	
HDA21088	#12 x 2 3/4	100	
HDA21096	#12 x 3	100	
HDA21112	#12 x 3 1/2	100	
HDA21128	#12 x 4	100	
HDA21144	#12 x 4 1/2	100	
HDA04024	#14 x 3/4	100	

(continued...)

**SLOTTED FLAT WOOD SCREW (cont.)**

ZINC PLATED

Line: 241-00

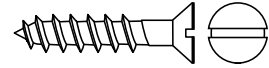

PART NUMBER	SIZE	QTY/BX	LIST PRICE
HDA04028	#14 x 7/8	100	
HDA04032	#14 x 1	100	
HDA04040	#14 x 1 1/4	100	
HDA04048	#14 x 1 1/2	100	
HDA04056	#14 x 1 3/4	100	
HDA04064	#14 x 2	100	
HDA04072	#14 x 2 1/4	100	
HDA04080	#14 x 2 1/2	100	
HDA04088	#14 x 2 3/4	100	
HDA04096	#14 x 3	100	
HDA04112	#14 x 3 1/2	100	
HDA04128	#14 x 4	50	
HDA04144	#14 x 4 1/2	50	
HDA04160	#14 x 5	50	
HDA04176	#14 x 5 1/2	100	
HDA04192	#14 x 6	50	
HDA61040	#16 x 1 1/4	100	
HDA61048	#16 x 1 1/2	100	
HDA61056X	#16 x 1 3/4	100	
HDA61064	#16 x 2	100	
HDA61080	#16 x 2 1/2	100	
HDA61088	#16 x 2 3/4	100	
HDA61096	#16 x 3	50	
HDA61112	#16 x 3 1/2	50	
HDA61128	#16 x 4	50	
HDA61144	#16 x 4 1/2	100	
HDA61160	#16 x 5	50	
HDA61192	#16 x 6	50	
HDA05032	#18 x 1	100	
HDA05040	#18 x 1 1/4	100	
HDA05048	#18 x 1 1/2	100	
HDA05056	#18 x 1 3/4	100	
HDA05064	#18 x 2	100	
HDA05080	#18 x 2 1/2	100	
HDA05088	#18 x 2 3/4	100	
HDA05096	#18 x 3	50	
HDA05112	#18 x 3 1/2	50	
HDA05128	#18 x 4	50	
HDA05144	#18 x 4 1/2	50	
HDA05160	#18 x 5	50	
HDA05192	#18 x 6	50	
HDA20048	#20 x 1 1/2	100	
HDA20056	#20 x 1 3/4	100	
HDA20160	#20 x 5	100	



**SLOTTED FLAT WOOD SCREW (cont.)**

ZINC PLATED

Line: 241-00

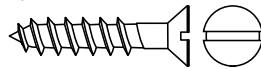

PART NUMBER	SIZE	QTY/BX	LIST PRICE
HDA06096	#24 x 3	50	
HDA06112	#24 x 3 1/2	50	
HDA06128	#24 x 4	50	
HDA06160	#24 x 5	50	
HDA06192	#24 x 6	50	

**SLOTTED ROUND WOOD SCREW**

ZINC PLATED

Line: 243-00

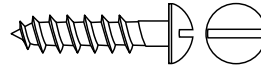

PART NUMBER	SIZE	QTY/BX	LIST PRICE
HFA00008	#0 x 1/4	100	
HFA00012	#0 x 3/8	100	
HFA11008X	#1 x 1/4	100	
HFA11012	#1 x 3/8	100	
HFA11016	#1 x 1/2	100	
HFA22008	#2 x 1/4	100	
HFA22012	#2 x 3/8	100	
HFA22016	#2 x 1/2	100	
HFA22020	#2 x 5/8	100	
HFA33008	#3 x 1/4	100	
HFA33012	#3 x 3/8	100	
HFA33016	#3 x 1/2	100	
HFA33020	#3 x 5/8	100	
HFA33024	#3 x 3/4	100	
HFA33032	#3 x 1	100	
HFA44008	#4 x 1/4	100	
HFA44012	#4 x 3/8	100	
HFA44016	#4 x 1/2	100	
HFA44020	#4 x 5/8	100	
HFA44024	#4 x 3/4	100	
HFA44028	#4 x 7/8	100	
HFA44032	#4 x 1	100	
HFA44040	#4 x 1 1/4	100	
HFA55012X	#5 x 3/8	100	
HFA55016	#5 x 1/2	100	
HFA55020	#5 x 5/8	100	
HFA55024	#5 x 3/4	100	
HFA55028	#5 x 7/8	100	
HFA55032	#5 x 1	100	
HFA55040	#5 x 1 1/4	100	
HFA55048	#5 x 1 1/2	100	
HFA66008X	#6 x 1/4	100	
HFA66012	#6 x 3/8	100	
HFA66016	#6 x 1/2	100	
HFA66020	#6 x 5/8	100	

(continued...)

**SLOTTED ROUND WOOD SCREW (cont.)**

ZINC PLATED

Line: 243-00

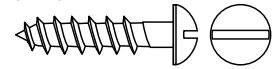

PART NUMBER	SIZE	QTY/BX	LIST PRICE
HFA66024	#6 x 3/4	100	
HFA66028	#6 x 7/8	100	
HFA66032	#6 x 1	100	
HFA66040	#6 x 1 1/4	100	
HFA66048	#6 x 1 1/2	100	
HFA66056	#6 x 1 3/4	100	
HFA66064	#6 x 2	100	
HFA66072	#6 x 2 1/4	100	
HFA66080	#6 x 2 1/2	100	
HFA77012X	#7 x 3/8	100	
HFA77016	#7 x 1/2	100	
HFA77020	#7 x 5/8	100	
HFA77024	#7 x 3/4	100	
HFA77028X	#7 x 7/8	100	
HFA77032	#7 x 1	100	
HFA77040	#7 x 1 1/4	100	
HFA77048	#7 x 1 1/2	100	
HFA77056	#7 x 1 3/4	100	
HFA77064	#7 x 2	100	
HFA77072X	#7 x 2 1/4	100	
HFA77080X	#7 x 2 1/2	100	
HFA88012	#8 x 3/8	100	
HFA88016	#8 x 1/2	100	
HFA88020	#8 x 5/8	100	
HFA88024	#8 x 3/4	100	
HFA88028	#8 x 7/8	100	
HFA88032	#8 x 1	100	
HFA88040	#8 x 1 1/4	100	
HFA88048	#8 x 1 1/2	100	
HFA88056	#8 x 1 3/4	100	
HFA88064	#8 x 2	100	
HFA88072	#8 x 2 1/4	100	
HFA88080	#8 x 2 1/2	100	
HFA88088	#8 x 2 3/4	100	
HFA88096	#8 x 3	100	
HFA99020	#9 x 5/8	100	
HFA99024	#9 x 3/4	100	
HFA99028	#9 x 7/8	100	
HFA99032	#9 x 1	100	
HFA99040	#9 x 1 1/4	100	
HFA99048	#9 x 1 1/2	100	
HFA99056	#9 x 1 3/4	100	
HFA99064	#9 x 2	100	
HFA99096X	#9 x 3	100	

(continued...)

**SLOTTED ROUND WOOD SCREW (cont.)**

ZINC PLATED  
Line: 243-00

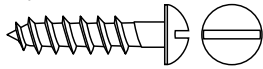

PART NUMBER	SIZE	QTY/BX	LIST PRICE
HFA99112X	#9 x 3 1/2	100	
HFA03016	#10 x 1/2	100	
HFA03020	#10 x 5/8	100	
HFA03024	#10 x 3/4	100	
HFA03028	#10 x 7/8	100	
HFA03032	#10 x 1	100	
HFA03040	#10 x 1 1/4	100	
HFA03048	#10 x 1 1/2	100	
HFA03056	#10 x 1 3/4	100	
HFA03064	#10 x 2	100	
HFA03072	#10 x 2 1/4	100	
HFA03080	#10 x 2 1/2	100	
HFA03088	#10 x 2 3/4	100	
HFA03096	#10 x 3	100	
HFA03112	#10 x 3 1/2	100	
HFA03128	#10 x 4	100	
HFA03144	#10 x 4 1/2	100	
HFA035020X	#11 x 5/8	100	
HFA21020X	#12 x 5/8	100	
HFA21024	#12 x 3/4	100	
HFA21028	#12 x 7/8	100	
HFA21032	#12 x 1	100	
HFA21040	#12 x 1 1/4	100	
HFA21048	#12 x 1 1/2	100	
HFA21056	#12 x 1 3/4	100	
HFA21064	#12 x 2	100	
HFA21072	#12 x 2 1/4	100	
HFA21080	#12 x 2 1/2	100	
HFA21088	#12 x 2 3/4	100	
HFA21096	#12 x 3	100	
HFA21112X	#12 x 3 1/2	100	
HFA21128X	#12 x 4	100	
HFA21144	#12 x 4 1/2	100	
HFA04020	#14 x 5/8	100	
HFA04024	#14 x 3/4	100	
HFA04028	#14 x 7/8	100	
HFA04032	#14 x 1	100	
HFA04040	#14 x 1 1/4	100	
HFA04048	#14 x 1 1/2	100	
HFA04056	#14 x 1 3/4	100	
HFA04064	#14 x 2	100	
HFA04072X	#14 x 2 1/4	100	
HFA04080	#14 x 2 1/2	100	
HFA04088	#14 x 2 3/4	100	

(continued...)

**SLOTTED ROUND WOOD SCREW (cont.)**

ZINC PLATED  
Line: 243-00

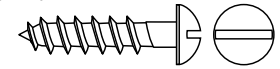

PART NUMBER	SIZE	QTY/BX	LIST PRICE
HFA04096	#14 x 3	100	
HFA04112	#14 x 3 1/2	100	
HFA04128	#14 x 4	100	
HFA61040X	#16 x 1 1/4	100	
HFA61128	#16 x 4	50	
HFA61144	#16 x 4 1/2	50	
HFA61160	#16 x 5	50	

**SLOTTED OVAL WOOD SCREW**

ZINC PLATED  
Line: 244-00



PART NUMBER	SIZE	QTY/BX	LIST PRICE
HGA22012	#2 x 3/8	100	
HGA33012	#3 x 3/8	100	
HGA33016	#3 x 1/2	100	
HGA33020	#3 x 5/8	100	
HGA33024	#3 x 3/4	100	
HGA33032	#3 x 1	100	
HGA33040X	#3 x 1 1/4	100	
HGA44016	#4 x 1/2	100	
HGA44020	#4 x 5/8	100	
HGA44024	#4 x 3/4	100	
HGA44032	#4 x 1	100	
HGA44040X	#4 x 1 1/4	100	
HGA44048	#4 x 1 1/2	100	
HGA55012X	#5 x 3/8	100	
HGA55016	#5 x 1/2	100	
HGA55020	#5 x 5/8	100	
HGA55024	#5 x 3/4	100	
HGA55028	#5 x 7/8	100	
HGA55032	#5 x 1	100	
HGA55040	#5 x 1 1/4	100	
HGA55048	#5 x 1 1/2	100	
HGA55056	#5 x 1 3/4	100	
HGA66012	#6 x 3/8	100	
HGA66016	#6 x 1/2	100	
HGA66020	#6 x 5/8	100	
HGA66024	#6 x 3/4	100	
HGA66028	#6 x 7/8	100	
HGA66032	#6 x 1	100	
HGA66040	#6 x 1 1/4	100	
HGA66048	#6 x 1 1/2	100	
HGA66064	#6 x 2	100	
HGA66080	#6 x 2 1/2	100	
HGA77020	#7 x 5/8	100	

(continued...)

## SLOTTED OVAL WOOD SCREW (cont.)

ZINC PLATED

Line: 244-00

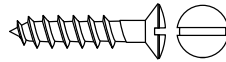

PART NUMBER	SIZE	QTY/BX	LIST PRICE
HGA77024	#7 x 3/4	100	
HGA77032	#7 x 1	100	
HGA77040	#7 x 1 1/4	100	
HGA77048	#7 x 1 1/2	100	
HGA88016	#8 x 1/2	100	
HGA88020	#8 x 5/8	100	
HGA88024	#8 x 3/4	100	
HGA88028	#8 x 7/8	100	
HGA88032	#8 x 1	100	
HGA88040	#8 x 1 1/4	100	
HGA88048	#8 x 1 1/2	100	
HGA88056	#8 x 1 3/4	100	
HGA88064	#8 x 2	100	
HGA88080	#8 x 2 1/2	100	
HGA88096	#8 x 3	100	
HGA99016	#9 x 1/2	100	
HGA99024	#9 x 3/4	100	
HGA99032	#9 x 1	100	
HGA99048	#9 x 1 1/2	100	
HGA99064	#9 x 2	100	
HGA99080	#9 x 2 1/2	100	
HGA03016	#10 x 1/2	100	
HGA03020	#10 x 5/8	100	
HGA03024	#10 x 3/4	100	
HGA03032	#10 x 1	100	
HGA03040	#10 x 1 1/4	100	
HGA03048	#10 x 1 1/2	100	
HGA03056	#10 x 1 3/4	100	
HGA03064	#10 x 2	100	
HGA03080	#10 x 2 1/2	100	
HGA03096	#10 x 3	100	
HGA21024	#12 x 3/4	100	
HGA21028	#12 x 7/8	100	
HGA21032	#12 x 1	100	
HGA21040	#12 x 1 1/4	100	
HGA21048	#12 x 1 1/2	100	
HGA21056	#12 x 1 3/4	100	
HGA21064	#12 x 2	100	
HGA04024	#14 x 3/4	100	
HGA04032	#14 x 1	100	
HGA04040	#14 x 1 1/4	100	
HGA04048	#14 x 1 1/2	100	
HGA04064	#14 x 2	100	
HGA04080X	#14 x 2 1/2	100	
HGA04096	#14 x 3	100	

## PHILLIPS FLAT WOOD SCREW

ZINC PLATED

Line: 245-00

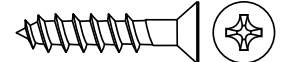

PART NUMBER	SIZE	QTY/BX	LIST PRICE
HHA33020	#3 x 5/8	100	
HHA33024	#3 x 3/4	100	
HHA44012	#4 x 3/8	100	
HHA44016	#4 x 1/2	100	
HHA44020	#4 x 5/8	100	
HHA44024	#4 x 3/4	100	
HHA44028	#4 x 7/8	100	
HHA44032	#4 x 1	100	
HHA44040	#4 x 1 1/4	100	
HHA44048	#4 x 1 1/2	100	
HHA55016	#5 x 1/2	100	
HHA55020	#5 x 5/8	100	
HHA55024	#5 x 3/4	100	
HHA55028	#5 x 7/8	100	
HHA55032	#5 x 1	100	
HHA55040	#5 x 1 1/4	100	
HHA66012	#6 x 3/8	100	
HHA66016	#6 x 1/2	100	
HHA66020	#6 x 5/8	100	
HHA66024	#6 x 3/4	100	
HHA66028	#6 x 7/8	100	
HHA66032	#6 x 1	100	
HHA66040	#6 x 1 1/4	100	
HHA66048	#6 x 1 1/2	100	
HHA66056	#6 x 1 3/4	100	
HHA66064	#6 x 2	100	
HHA66072	#6 x 2 1/4	100	
HHA66080	#6 x 2 1/2	100	
HHA77016	#7 x 1/2	100	
HHA77020	#7 x 5/8	100	
HHA77024	#7 x 3/4	100	
HHA77028	#7 x 7/8	100	
HHA77032	#7 x 1	100	
HHA77040	#7 x 1 1/4	100	
HHA77048	#7 x 1 1/2	100	
HHA77056	#7 x 1 3/4	100	
HHA77064	#7 x 2	100	
HHA77080	#7 x 2 1/2	100	
HHA88016	#8 x 1/2	100	
HHA88020	#8 x 5/8	100	
HHA88024	#8 x 3/4	100	
HHA88028	#8 x 7/8	100	
HHA88032	#8 x 1	100	
HHA88040	#8 x 1 1/4	100	

(continued...)

**PHILLIPS FLAT WOOD SCREW (cont.)**

ZINC PLATED

Line: 245-00

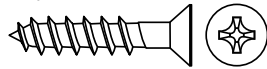

PART NUMBER	SIZE	QTY/BX	LIST PRICE
HHA88048	#8 x 1 1/2	100	
HHA88056	#8 x 1 3/4	100	
HHA88064	#8 x 2	100	
HHA88072	#8 x 2 1/4	100	
HHA88080	#8 x 2 1/2	100	
HHA88088X	#8 x 2 3/4	100	
HHA88096	#8 x 3	100	
HHA88112	#8 x 3 1/2	100	
HHA99016	#9 x 1/2	100	
HHA99024	#9 x 3/4	100	
HHA99032	#9 x 1	100	
HHA99040	#9 x 1 1/4	100	
HHA99048	#9 x 1 1/2	100	
HHA99056	#9 x 1 3/4	100	
HHA99064	#9 x 2	100	
HHA99072	#9 x 2 1/4	100	
HHA99080	#9 x 2 1/2	100	
HHA99088	#9 x 2 3/4	100	
HHA99096	#9 x 3	100	
HHA03016	#10 x 1/2	100	
HHA03020	#10 x 5/8	100	
HHA03024	#10 x 3/4	100	
HHA03028	#10 x 7/8	100	
HHA03032	#10 x 1	100	
HHA03040	#10 x 1 1/4	100	
HHA03048	#10 x 1 1/2	100	
HHA03056	#10 x 1 3/4	100	
HHA03064	#10 x 2	100	
HHA03072	#10 x 2 1/4	100	
HHA03080	#10 x 2 1/2	100	
HHA03088	#10 x 2 3/4	100	
HHA03096	#10 x 3	100	
HHA03112	#10 x 3 1/2	100	
HHA03128X	#10 x 4	100	
HHA21024	#12 x 3/4	100	
HHA21032	#12 x 1	100	
HHA21040	#12 x 1 1/4	100	
HHA21048	#12 x 1 1/2	100	
HHA21056	#12 x 1 3/4	100	
HHA21064	#12 x 2	100	
HHA21072	#12 x 2 1/4	100	
HHA21080	#12 x 2 1/2	100	
HHA21096	#12 x 3	100	
HHA21112X	#12 x 3 1/2	100	

(continued...)

**PHILLIPS FLAT WOOD SCREW (cont.)**

ZINC PLATED

Line: 245-00

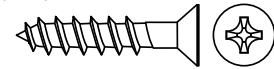

PART NUMBER	SIZE	QTY/BX	LIST PRICE
HHA21128	#12 x 4	100	
HHA21160	#12 x 5	100	
HHA04024	#14 x 3/4	100	
HHA04028	#14 x 7/8	100	
HHA04032	#14 x 1	100	
HHA04040	#14 x 1 1/4	100	
HHA04048	#14 x 1 1/2	100	
HHA04056	#14 x 1 3/4	100	
HHA04064	#14 x 2	100	
HHA04072	#14 x 2 1/4	100	
HHA04080	#14 x 2 1/2	100	
HHA04096	#14 x 3	100	
HHA04112X	#14 x 3 1/2	100	
HHA04128X	#14 x 4	100	
HHA04144	#14 x 4 1/2	50	
HHA04160	#14 x 5	50	
HHA04192	#14 x 6	50	
HHA61080	#16 x 2 1/2	100	
HHA61128	#16 x 4	100	
HHA05040X	#18 x 1 1/4	100	
HHA05048	#18 x 1 1/2	100	
HHA05128	#18 x 4	50	
HHA20064	#20 x 2	50	
HHA20112	#20 x 3 1/2	50	
HHA20128	#20 x 4	50	
HHA06128	#24 x 4	50	
HHA06160	#24 x 5	50	



**CALL - 1 (800) 723-2826**

## PHILLIPS ROUND WOOD SCREW

ZINC PLATED

Line: 245-01

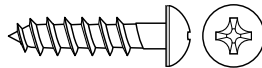

PART NUMBER	SIZE	QTY/BX	LIST PRICE
JPG22008	#2 x 1/4	100	
JPG44016	#4 x 1/2	100	
JPG44024X	#4 x 3/4	100	
JPG44028	#4 x 7/8	100	
JPG55016	#5 x 1/2	100	
JPG55020	#5 x 5/8	100	
JPG55024	#5 x 3/4	100	
JPG55032	#5 x 1	100	
JPG66016	#6 x 1/2	100	
JPG66020	#6 x 5/8	100	
JPG66024	#6 x 3/4	100	
JPG66032X	#6 x 1	100	
JPG66040	#6 x 1 1/4	100	
JPG66048X	#6 x 1 1/2	100	
JPG66056X	#6 x 1 3/4	100	
JPG77016	#7 x 1/2	100	
JPG77020	#7 x 5/8	100	
JPG77024	#7 x 3/4	100	
JPG77032	#7 x 1	100	
JPG77040	#7 x 1 1/4	100	
JPG77048	#7 x 1 1/2	100	
JPG77064	#7 x 2	100	
JPG88016X	#8 x 1/2	100	
JPG88020	#8 x 5/8	100	
JPG88024	#8 x 3/4	100	
JPG88028	#8 x 7/8	100	
JPG88032	#8 x 1	100	
JPG88040X	#8 x 1 1/4	100	
JPG88048ZPX	#8 x 1 1/2	100	
JPG88064	#8 x 2	100	
JPG99020	#9 x 5/8	100	
JPG99024	#9 x 3/4	100	
JPG99032	#9 x 1	100	
JPG99040	#9 x 1 1/4	100	
JPG99048	#9 x 1 1/2	100	
JPG03024	#10 x 3/4	100	
JPG03032	#10 x 1	100	
JPG03040	#10 x 1 1/4	100	
JPG03048	#10 x 1 1/2	100	
JPG03064	#10 x 2	100	
JPG03080	#10 x 2 1/2	100	
JPG21020	#12 x 5/8	100	
JPG21024	#12 x 3/4	100	
JPG21032	#12 x 1	100	

(continued...)

## PHILLIPS ROUND WOOD SCREW (cont.)

ZINC PLATED

Line: 245-01

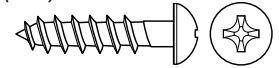

PART NUMBER	SIZE	QTY/BX	LIST PRICE
JPG21040	#12 x 1 1/4	100	
JPG21048	#12 x 1 1/2	100	
JPG21064	#12 x 2	100	
JPG21080	#12 x 2 1/2	100	
JPG04028	#14 x 7/8	100	
JPG04032	#14 x 1	100	
JPG04040	#14 x 1 1/4	100	
JPG04048	#14 x 1 1/2	100	
JPG04064	#14 x 2	100	

## PHILLIPS OVAL WOOD SCREW

ZINC PLATED

Line: 245-02

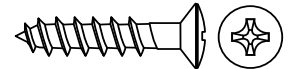

PART NUMBER	SIZE	QTY/BX	LIST PRICE
JEK44016X	#4 x 1/2	100	
JEK44020X	#4 x 5/8	100	
JEK44024	#4 x 3/4	100	
JEK44032	#4 x 1	100	
JEK55016	#5 x 1/2	100	
JEK55020X	#5 x 5/8	100	
JEK55024	#5 x 3/4	100	
JEK66020	#6 x 5/8	100	
JEK66024	#6 x 3/4	100	
JEK66028	#6 x 7/8	100	
JEK66032	#6 x 1	100	
JEK66040	#6 x 1 1/4	100	
JEK66048	#6 x 1 1/2	100	
JEK88024	#8 x 3/4	100	
JEK88028X	#8 x 7/8	100	
JEK88032	#8 x 1	100	
JEK88040	#8 x 1 1/4	100	
JEK88048	#8 x 1 1/2	100	
JEK88056	#8 x 1 3/4	100	
JEK88064	#8 x 2	100	
JEK88096X	#8 x 3	100	
JEK99024	#9 x 3/4	100	
JEK03024X	#10 x 3/4	100	
JEK03032	#10 x 1	100	
JEK03040	#10 x 1 1/4	100	
JEK03048X	#10 x 1 1/2	100	
JEK03056X	#10 x 1 3/4	100	
JEK03064	#10 x 2	100	

## SQUARE DRIVE FLAT HEAD WOOD SCREW

ZINC PLATED

Line: 245-06

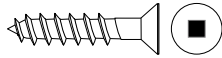

PART NUMBER	SIZE	QTY/BX	LIST PRICE
CAW44024	#4 x 3/4	100	
CAW66016	#6 x 1/2	100	
CAW66020	#6 x 5/8	100	
CAW66024	#6 x 3/4	100	
CAW66032	#6 x 1	100	
CAW66040	#6 x 1 1/4	100	
CAW66048	#6 x 1 1/2	100	
CAW66064	#6 x 2	100	
CAW88024	#8 x 3/4	100	
CAW88032	#8 x 1	100	
CAW88040	#8 x 1 1/4	100	
CAW88048	#8 x 1 1/2	100	
CAW88056	#8 x 1 3/4	100	
CAW88064	#8 x 2	100	
CAW88080	#8 x 2 1/2	100	
CAW88096	#8 x 3	100	
CAW03024	#10 x 3/4	100	
CAW03032	#10 x 1	100	
CAW03040	#10 x 1 1/4	100	
CAW03048	#10 x 1 1/2	100	
CAW03056	#10 x 1 3/4	100	
CAW03064	#10 x 2	100	
CAW03080	#10 x 2 1/2	100	
CAW03096	#10 x 3	100	
CAW03128	#10 x 4	100	
CAW21032	#12 x 1	100	
CAW21040	#12 x 1 1/4	100	
CAW21048	#12 x 1 1/2	100	
CAW21056	#12 x 1 3/4	100	
CAW21064	#12 x 2	100	
CAW21080	#12 x 2 1/2	100	
CAW21096	#12 x 3	100	
CAW21112	#12 x 3 1/2	100	
CAW21128	#12 x 4	100	
CAW04040	#14 x 1 1/4	100	
CAW04048	#14 x 1 1/2	100	
CAW04056	#14 x 1 3/4	100	
CAW04064	#14 x 2	100	
CAW04080	#14 x 2 1/2	100	
CAW04096	#14 x 3	100	
CAW04112	#14 x 3 1/2	100	
CAW04128	#14 x 4	100	

## QUADREX DRIVE FLAT HEAD WOOD SCREW

ZINC PLATED

Line: 245-07

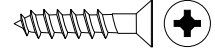

PART NUMBER	SIZE	QTY/BX	LIST PRICE
CET66024	#6 x 3/4	100	
CET66032	#6 x 1	100	
CET66040	#6 x 1 1/4	100	
CET66048	#6 x 1 1/2	100	
CET88024	#8 x 3/4	100	
CET88032	#8 x 1	100	
CET03032	#10 x 1	100	
CET03040	#10 x 1 1/4	100	
CET03048	#10 x 1 1/2	100	

## OVERHEAD GARAGE DOOR SCREW

FLAT HEAD CARRIAGE BOLT 5/8" - ZINC PLATED

Line: 245-10



PART NUMBER	SIZE	QTY/BX	LIST PRICE
CCV04060FH	1/4 x 1 7/8	100	
CCV04072FH	1/4 x 2 1/4	100	

## OVERHEAD GARAGE DOOR SCREW

RIBBED TRACKSCREW - ZINC PLATED

Line: 245-10

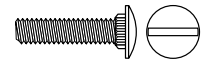

PART NUMBER	SIZE	QTY/BX	LIST PRICE
CCV04020RTS	1/4 x 5/8	100	

## OVERHEAD GARAGE DOOR SCREW

SERRATED HEX WASHER HEAD 7/16" - ZINC

Line: 245-10

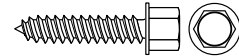

PART NUMBER	SIZE	QTY/BX	LIST PRICE
CCV04024TK	14 x 3/4	100	
CCV04032TK	14 x 1	100	
CCV05032TK	5/16 x 1	100	



CALL - 1 (800) 723-2826

## OVERHEAD GARAGE DOOR SCREW

HEX WASHER HEAD SMS 7/16" AF - ZINC

Line: 245-10

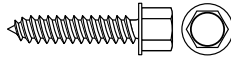

PART NUMBER	SIZE	QTY/BX	LIST PRICE
CCV04024	14 x 3/4 (Serrated)	100	
CCV04032	14 x 1	100	
CCV05052	5/16 x 1 5/8	100	
CCV05080	5/16 x 2-1/2	100	

## OVERHEAD GARAGE DOOR SCREW

HIGH HEX WASHER HEAD SMS 7/16" - ZINC

Line: 245-10

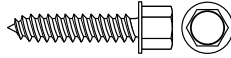

PART NUMBER	SIZE	QTY/BX	LIST PRICE
CCV05052HI	5/16 x 1 5/8	100	
CCV05064HI	5/16 x 2	100	

## SQUARE/PHILLIPS FLAT HEAD SCREW COVERS

COLORED

Line: 245-11



PART NUMBER	SIZE	QTY/BX	LIST PRICE
CCW2PAL	#2 Phillips (Almond)	200	
CCW2PBK	#2 Phillips (Black)	200	
CCW2PDBR	#2 Phillips (Dark Brown)	200	
CCW2PLGY	#2 Phillips (Light Grey)	200	
CCW2PWH	#2 Phillips (White)	200	
CCW2S3PAL	#2SQ/#2PH (Almond)	200	
CCW2S3PBK	#2SQ/#2PH (Black)	200	
CCW2S3PDBR	#2SQ/#2PH (Dark Brown)	200	
CCW2S3PLGY	#2SQ/#2PH (Light Grey)	200	
CCW2S3PWH	#2SQ/#2PH (White)	200	

## PHILLIPS/TRUSS DEEP THREAD

PAINTED HEAD SCREWS

Line: 245-12

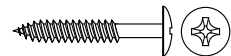

PART NUMBER	SIZE	QTY/BX	LIST PRICE
CCW88080NS	#8 x 2 1/2 Needle Pt. (Sand)	100	
CCW88080NW	#8 x 2 1/2 Needle Pt. (White)	100	
CCW88080NZ	#8 x 2 1/2 Needle Pt. (Zinc)	100	
CCW03080BK	#10 x 2 1/2 (Black)	100	
CCW03080S	#10 x 2 1/2 (Sand)	100	
CCW03080W	#10 x 2 1/2 (White)	100	
CCW03080Z	#10 x 2 1/2 (Zinc)	100	
CCW03080TKS	#10 x 2 1/2 SelfDrill (Sand)	100	
CCW03080TKW	#10 x 2 1/2 SelfDrill (White)	100	
CCW03080TKZ	#10 x 2 1/2 SelfDrill (Zinc)	100	
CCW03096BK	#10 x 3 (Black)	100	
CCW03096S	#10 x 3 (Sand)	100	
CCW03096W	#10 x 3 (White)	100	
CCW03096Z	#10 x 3 (Zinc)	100	

## RD WASH SQUARE DRIVE DEEP THREAD

CABINET SCREWS - ZINC PLATED

Line: 245-13

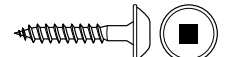

PART NUMBER	SIZE	QTY/BX	LIST PRICE
CCW88024SRW	#8 x 3/4 (Auger Pt.)	200	
CCW88032SRW	#8 x 1 (Full Thread)	200	
CCW88036SRW	#8 x 1 1/8 (2/3 Thread)	200	
CCW88040SRW	#8 x 1 1/4 (2/3 Thread)	200	
CCW88048SRW	#8 x 1 1/2 (2/3 Thread)	200	
CCW88056SRW	#8 x 1 3/4 (2/3 Thread)	200	
CCW88064SRW	#8 x 2 (2/3 Thread)	200	
CCW88080SRW	#8 x 2 1/2 (2/3 Thread)	200	
CCW88096SRW	#8 x 3 (2/3 Thread)	100	
CCW88128SRW	#8 x 4 (2/3 Thread)	100	

## MOD/TRUSS PHILLIPS WASH HD

CABINET SCREWS - ZINC PLATED

Line: 245-14

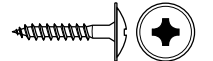

PART NUMBER	SIZE	QTY/BX	LIST PRICE
CCW88028PRW	#8 x 7/8 (Full Thread)	200	
CCW88032PRW	#8 x 1 (1/2 Thread)	200	
CCW88036PRW	#8 x 1 1/8 (1/2 Thread)	200	
CCW88040PRW	#8 x 1 1/4 (1/2 Thread)	200	
CCW88048PRW	#8 x 1 1/2 (2/3 Thread)	200	

## HINGE & DRAWER SLIDE SCREWS

ASSORTED

Line: 245-15



PART NUMBER	SIZE	QTY/BX	LIST PRICE
CCW55016NF	5 x 1/2 (Phil/Flat, Nickel)	200	
CCW55020NF	5 x 5/8 (Phil/Flat, Nickel)	200	
CCW55020AV	5 x 5/8 (Phil/Oval, Antique Brass)	200	
CCW55020BV	5 x 5/8 (Phil/Oval, Bright Brass)	200	
CCW66016NF	6 x 1/2 (Phil/Flat, Nickel)	200	
CCW66020NF	6 x 5/8 (Phil/Flat, Nickel)	200	
CCW66020BV	6 x 5/8 (Phil/Oval, Bright Brass)	200	
CCW66020AV	6 x 5/8 (Phil/Oval, Antique Brass)	200	
CCW77024NF	7 x 3/4 (Phil/Flat, Nickel)	200	

## SQ & PH PAN FRAMING SCREWS

T-17 PT BLACK

Line: 245-16

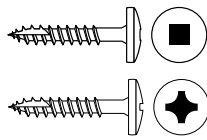

PART NUMBER	SIZE	QTY/BX	LIST PRICE
CCW66040PFS	6 x 1 1/4 (#2 Phillips)	200	
CCW66040SFS	6 x 1 1/4 (#2 Square)	200	
CCW66048PFS	6 x 1 1/2 (#2 Phillips)	200	
CCW66048SFS	6 x 1 1/2 (#2 Square)	200	

## HEX HEAD DRAWER BOLT

JOINT ASSEMBLY

Line: 245-17

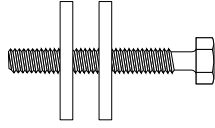

PART NUMBER	SIZE	QTY/BX	LIST PRICE
CCW04112DR	1/4-20 x 3 1/2	25	

## PHILLIPS FLAT EURO DRAWER SLIDE

CABINET SCREW NKL

Line: 245-18



PART NUMBER	SIZE	QTY/BX	LIST PRICE
CCW05013EURO	M5 x 13 (7.5mm Head)	200	

## THUMB SCREW TYPE P - NO SHOULDER

ZINC PLATED

Line: 246-00

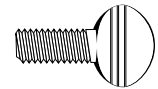

PART NUMBER	SIZE	QTY/BX	LIST PRICE
KEA66008X	#6-32 x 1/4	100	
KEA66012	#6-32 x 3/8	100	
KEA66016	#6-32 x 1/2	100	
KEA66024	#6-32 x 3/4	100	
KEA66032	#6-32 x 1	100	
KEA88012X	#8-32 x 3/8	100	
KEA88016	#8-32 x 1/2	100	
KEA88020	#8-32 x 5/8	100	
KEA88024	#8-32 x 3/4	100	
KEA88032	#8-32 x 1	100	
KEA03012	#10-24 x 3/8	100	
KEA03016	#10-24 x 1/2	100	
KEA03020	#10-24 x 5/8	100	
KEA03024	#10-24 x 3/4	100	
KEA03032	#10-24 x 1	100	
KEA03040	#10-24 x 1 1/4	100	
KEA03048	#10-24 x 1 1/2	100	
KEA03064	#10-24 x 2	100	
KEAS03012	#10-32 x 3/8	100	
KEAS03016	#10-32 x 1/2	100	
KEAS03020	#10-32 x 5/8	100	
KEAS03024	#10-32 x 3/4	100	
KEAS03032	#10-32 x 1	100	
KEAS03040	#10-32 x 1 1/4	100	
KEAS03048	#10-32 x 1 1/2	100	
KEAS03064	#10-32 x 2	100	
KEA04012	1/4-20 x 3/8	100	
KEA04016	1/4-20 x 1/2	100	
KEA04020	1/4-20 x 5/8	100	
KEA04024	1/4-20 x 3/4	100	
KEA04032	1/4-20 x 1	100	
KEA04040	1/4-20 x 1 1/4	100	
KEA04048	1/4-20 x 1 1/2	100	
KEA04056	1/4-20 x 1 3/4	100	
KEA04064	1/4-20 x 2	100	
KEA04080	1/4-20 x 2 1/2	100	
KEA04096	1/4-20 x 3	100	
KEA05016	5/16-18 x 1/2	100	
KEA05024	5/16-18 x 3/4	100	
KEA05032	5/16-18 x 1	100	
KEA05040	5/16-18 x 1 1/4	100	
KEA05048	5/16-18 x 1 1/2	100	
KEA05064	5/16-18 x 2	100	
KEA05080	5/16-18 x 2 1/2	100	

(continued...)



### THUMB SCREW TYPE P - NO SHOULDER (cont.)

ZINC PLATED

Line: 246-00

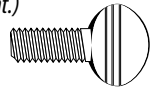

PART NUMBER	SIZE	QTY/BX	LIST PRICE
KEA05096	5/16-18 x 3	50	
KEA06024	3/8-16 x 3/4	50	
KEA06032	3/8-16 x 1	50	
KEA06040	3/8-16 x 1 1/4	50	
KEA06048	3/8-16 x 1 1/2	50	
KEA06064	3/8-16 x 2	50	
KEA06080	3/8-16 x 2 1/2	50	
KEA06096	3/8-16 x 3	50	
KEA08048	1/2-13 x 1 1/2	25	
KEA08096	1/2-13 x 3	25	
KEA08128	1/2-13 x 4	25	

### THUMB SCREW TYPE S - WITH SHOULDER

PLAIN AND ZINC PLATED

Line: 247-00

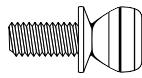

PART NUMBER	SIZE	QTY/BX	LIST PRICE
KFA66012	#6-32 x 3/8	100	
KFA66012PST	#6-32 x 3/8 (Plain)	100	
KFA66016	#6-32 x 1/2	100	
KFA66016PST	#6-32 x 1/2 (Plain)	100	
KFA66020	#6-32 x 5/8	100	
KFA66024	#6-32 x 3/4	100	
KFA66024PST	#6-32 x 3/4 (Plain)	100	
KFA88016	#8-32 x 1/2	100	
KFA88016PST	#8-32 x 1/2 (Plain)	100	
KFA88020	#8-32 x 5/8	100	
KFA88024	#8-32 x 3/4	100	
KFA88024PST	#8-32 x 3/4 (Plain)	100	
KFA03016	#10-24 x 1/2	100	
KFA03016PST	#10-24 x 1/2 (Plain)	100	
KFA03020	#10-24 x 5/8	100	
KFA03024	#10-24 x 3/4	100	
KFA03024PST	#10-24 x 3/4 (Plain)	100	
KFA03032	#10-24 x 1	100	
KFA03032PST	#10-24 x 1 (Plain)	100	
KFA03040	#10-24 x 1 1/4	100	
KFA03048	#10-24 x 1 1/2	100	
KFA03048PST	#10-24 x 1 1/2 (Plain)	100	
KFA03064X	#10-24 x 2	100	
KFA03064PST	#10-24 x 2 (Plain)	100	
KFAS03016	#10-32 x 1/2	100	
KFAS03016PST	#10-32 x 1/2 (Plain)	100	
KFAS03020	#10-32 x 5/8	100	
KFAS03024	#10-32 x 3/4	100	

(continued...)

### THUMB SCREW TYPE S - WITH SHOULDER (cont.)

PLAIN AND ZINC PLATED

Line: 247-00

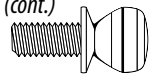

PART NUMBER	SIZE	QTY/BX	LIST PRICE
KFAS03024PST	#10-32 x 3/4 (Plain)	100	
KFAS03032	#10-32 x 1	100	
KFAS03032PST	#10-32 x 1 (Plain)	100	
KFAS03040	#10-32 x 1 1/4	100	
KFAS03048	#10-32 x 1 1/2	100	
KFAS03048PST	#10-32 x 1 1/2 (Plain)	100	
KFAS03064X	#10-32 x 2	100	
KFA04016	1/4-20 x 1/2	100	
KFA04016PST	1/4-20 x 1/2 (Plain)	100	
KFA04020	1/4-20 x 5/8	100	
KFA04024	1/4-20 x 3/4	100	
KFA04024PST	1/4-20 x 3/4 (Plain)	100	
KFA04032	1/4-20 x 1	100	
KFA04032PST	1/4-20 x 1 (Plain)	100	
KFA04040	1/4-20 x 1 1/4	100	
KFA04040PST	1/4-20 x 1 1/4 (Plain)	100	
KFA04048	1/4-20 x 1 1/2	100	
KFA04048PST	1/4-20 x 1 1/2 (Plain)	100	
KFA04064	1/4-20 x 2	100	
KFA04064PST	1/4-20 x 2 (Plain)	100	
KFA04080	1/4-20 x 2 1/2	100	
KFA04080PST	1/4-20 x 2 1/2 (Plain)	100	
KFA05016	5/16-18 x 1/2	100	
KFA05016PST	5/16-18 x 1/2 (Plain)	100	
KFA05024	5/16-18 x 3/4	100	
KFA05024PST	5/16-18 x 3/4 (Plain)	100	
KFA05032	5/16-18 x 1	100	
KFA05032PST	5/16-18 x 1 (Plain)	100	
KFA05040	5/16-18 x 1 1/4	100	
KFA05048	5/16-18 x 1 1/2	100	
KFA05048PST	5/16-18 x 1 1/2 (Plain)	100	
KFA05064	5/16-18 x 2	100	
KFA05064PST	5/16-18 x 2 (Plain)	100	
KFA06024	3/8-16 x 3/4	50	
KFA06024PST	3/8-16 x 3/4 (Plain)	100	
KFA06032	3/8-16 x 1	50	
KFA06032PST	3/8-16 x 1 (Plain)	100	
KFA06040	3/8-16 x 1 1/4	50	
KFA06040PST	3/8-16 x 1 1/4 (Plain)	50	
KFA06048	3/8-16 x 1 1/2	50	
KFA06048PST	3/8-16 x 1 1/2 (Plain)	50	
KFA06064	3/8-16 x 2	50	
KFA06096	3/8-16 x 3	50	

## THUMB SCREW SOCKET HEAD

PRESS ON KNOBS

Line: 247-01



PART NUMBER	SIZE	QTY/BX	LIST PRICE
CDL902BKN	#10 (5/8 OD, Knurled Knob)	10	
CDL904BKN	1/4 (1 OD, Knurled Knob)	10	
CDL903BKN	1/4 (3/4 OD, Knurled Knob)	10	
CDL907BROS	1/4 (Rosette Knob)	5	
CDL908BROS	5/16 (Rosette Knob)	5	

## ROUND HEAD U-DRIVE SCREWS (cont.)

ZINC PLATED

Line: 250-00

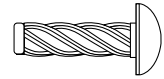

PART NUMBER	SIZE	QTY/BX	LIST PRICE
ZUB21020	#12 x 5/8	500	
ZUB21024	#12 x 3/4	500	
ZUB14016X	#14 x 1/2	100	
ZUB14020	#14 x 5/8	100	
ZUB14024X	#14 x 3/4	100	

## ROUND HEAD U-DRIVE SCREWS

ZINC PLATED

Line: 250-00

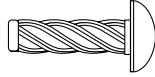

PART NUMBER	SIZE	QTY/BX	LIST PRICE
ZUB00004	#00 x 1/8	1000	
ZUB00006	#00 x 3/16	1000	
ZUB00008	#00 x 1/4	1000	
ZUB00012	#00 x 3/8	1000	
ZUB0004	#0 x 1/8	1000	
ZUB0006	#0 x 3/16	1000	
ZUB0008	#0 x 1/4	1000	
ZUB0010	#0 x 5/16	1000	
ZUB0012	#0 x 3/8	1000	
ZUB2004	#2 x 1/8	1000	
ZUB2006	#2 x 3/16	1000	
ZUB2008	#2 x 1/4	1000	
ZUB2010	#2 x 5/16	1000	
ZUB2012	#2 x 3/8	1000	
ZUB4006	#4 x 3/16	1000	
ZUB4008	#4 x 1/4	1000	
ZUB4010	#4 x 5/16	1000	
ZUB4012	#4 x 3/8	1000	
ZUB6006	#6 x 3/16	1000	
ZUB6008	#6 x 1/4	1000	
ZUB6010	#6 x 5/16	1000	
ZUB6012	#6 x 3/8	1000	
ZUB6016	#6 x 1/2	1000	
ZUB7010	#7 x 5/16	1000	
ZUB7012	#7 x 3/8	1000	
ZUB7016	#7 x 1/2	1000	
ZUB8012	#8 x 3/8	1000	
ZUB8016	#8 x 1/2	1000	
ZUB8020	#8 x 5/8	1000	
ZUB10012	#10 x 3/8	500	
ZUB10016	#10 x 1/2	500	
ZUB10020	#10 x 5/8	500	
ZUB21016	#12 x 1/2	500	

(continued...)



**CALL - 1 (800) 723-2826**

# SECTION 6 PRODUCT INDEX

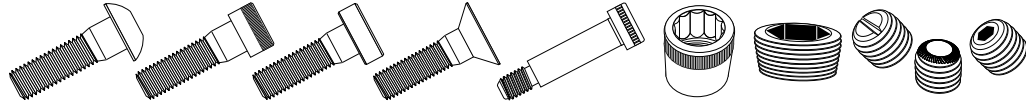

Line Description	Alpha	Line#	Page#
SOCKET HEAD CAP SCREWS - DOMESTIC - PLAIN	<b>HYA</b>	<b>253-00</b>	6-3
FLAT SOCKET HEAD CAP SCREWS - DOMESTIC - PLAIN	<b>JCA</b>	<b>256-00</b>	6-7
BUTTON SOCKET HEAD CAP SCREWS - DOMESTIC - PLAIN	<b>JGA</b>	<b>260-00</b>	6-8
LOW HEAD SOCKET HEAD CAP SCREWS - DOMESTIC - PLAIN	<b>JLA</b>	<b>263-00</b>	6-9
SOCKET SET SCREW CUP POINT - DOMESTIC - PLAIN	<b>JMA</b>	<b>264-00</b>	6-9
SOCKET SET SCREW CUP POINT - ZINC PLATED	<b>JNA</b>	<b>265-00</b>	6-12
SOCKET SET SCREW FLAT POINT - PLAIN	<b>JSA</b>	<b>267-00</b>	6-12
SOCKET SET SCREW CONE POINT - PLAIN	<b>JTA</b>	<b>268-00</b>	6-13
SOCKET SET SCREW 1/2 DOG POINT POINT - PLAIN	<b>JUA</b>	<b>269-00</b>	6-14
SOCKET SET SCREW FULL DOG POINT POINT - PLAIN	<b>JGE</b>	<b>269-01</b>	6-14
SOCKET SET SCREW OVAL DOG POINT POINT - PLAIN	<b>JVA</b>	<b>270-00</b>	6-14
SOCKET SET SCREW KNURL DOG POINT POINT - PLAIN	<b>JWA</b>	<b>271-00</b>	6-15
SOCKET SET JAM HOLLOWLOCK DOMESTIC - PLAIN	<b>JXA</b>	<b>272-00</b>	6-17
SLOTTED SET SCREWS CUP POINT - PLAIN	<b>JFE</b>	<b>272-01</b>	6-17
SQUARE HEAD SET SCREW CUP POINT - CASE HARDENED	<b>KBA</b>	<b>273-00</b>	6-18
12 POINT COUNTERBORE ALLOY CAP SCREW - PLAIN	<b>KCA</b>	<b>274-00</b>	6-19
SOCKET SHOULDER (STRIPPER) SCREW - DOMESTIC - PLAIN	<b>KJA</b>	<b>276-00</b>	6-20
SHORT ARM HEX KEY ALLOY - DOMESTIC	<b>DKC</b>	<b>277-00</b>	6-21
LONG ARM HEX KEY ALLOY - DOMESTIC	<b>DLC</b>	<b>278-00</b>	6-22
6" LONG ARM HEX KEY ALLOY - DOMESTIC	<b>AJY</b>	<b>278-01</b>	6-22
12" LONG ARM HEX KEY ALLOY - DOMESTIC	<b>AJZ</b>	<b>278-02</b>	6-22
MULTI ANGLE BALL HEX KEY - DOMESTIC	<b>AKD</b>	<b>278-03</b>	6-22
METRIC SHORT ARM HEX KEY - DOMESTIC	<b>AKE</b>	<b>278-04</b>	6-23
METRIC LONG ARM HEX KEY - DOMESTIC	<b>AKF</b>	<b>278-05</b>	6-23
MULTI ANGLE DRIVE BITS & SETS - DOMESTIC	<b>AKH</b>	<b>278-07</b>	6-23
GLOBAL SHORT ARM HEX KEY - ALLOY	<b>CFV</b>	<b>278-08</b>	6-23
GLOBAL LONG ARM HEX KEY - ALLOY	<b>CFW</b>	<b>278-09</b>	6-23
HEX KEY CADDY ISLAND - DOMESTIC	<b>AJX</b>	<b>278-20</b>	6-24
HEX KEY SETS IN POUCH - DOMESTIC	<b>ZWB</b>	<b>279-00</b>	6-24
HEX KEY SETS IN BOX - DOMESTIC	<b>ALB</b>	<b>279-01</b>	6-24
HEX KEY SETS IN BOX OR SLEEVE - DOMESTIC	<b>ABM</b>	<b>279-02</b>	6-24
TEE HANDLE CUSHION GRIP KEYS & SETS - DOMESTIC	<b>AKK</b>	<b>279-05</b>	6-24
TEE HANDLE HEX KEY - ALLOY - DOMESTIC	<b>ZXB</b>	<b>280-00</b>	6-25
FOLDING HEX KEY SET- ALLOY - DOMESTIC	<b>XYB</b>	<b>281-00</b>	6-25
TEE HANDLE HEX KEY SET- DOMESTIC	<b>ZZB</b>	<b>282-00</b>	6-25
TEE HANDLE KEY STAND	<b>ZZB</b>	<b>282-01</b>	6-25
SOCKET PIPE PLUG ALLOY 3/4" TAPER - DOMESTIC	<b>MEB</b>	<b>283-00</b>	6-25
SOCKET PIPE PLUG ALLOY 7/8" TAPER - DOMESTIC	<b>MFB</b>	<b>284-00</b>	6-26
SOCKET PIPE PLUG STAINLESS STEEL 3/4" TAPER - DOMESTIC	<b>MGB</b>	<b>285-00</b>	6-26
SHAFT COLLARS W/SET SCREW - STAINLESS STEEL	<b>ASH</b>	<b>285-75</b>	6-26

(CONTINUED...)

# SECTION 6 PRODUCT INDEX

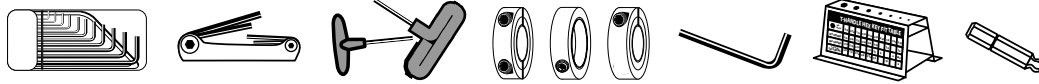

Line Description	Alpha	Line#	Page#
ALLEN SOCKET NUT - ALLOY - DOMESTIC	JHD	286-00	6-26
SHAFT COLLARS W/SET SCREW - STEEL	HED	286-01	6-26
SHAFT COLLARS CLAMP STYLE - STEEL - 1 PIECE	DRC	286-02	6-27
SHAFT COLLARS CLAMP STYLE - STEEL - 2 PIECE	JND	286-03	6-28
SHAFT COLLARS CLAMP STYLE - STAINLESS STEEL - 1 & 2 PIECE	DSC	286-04	6-28
STANDARD SOCKET HEAD CAP SCREWS - PLAIN	JMR	286-05	6-28
STANDARD SOCKET SET SCREWS CUP POINT - PLAIN	JNR	286-06	6-33
STANDARD FLAT SOCKET CAP SCREWS - PLAIN	JPR	286-07	6-36
STANDARD BUTTON SOCKET CAP SCREWS - PLAIN	ABS	286-08	6-38
STANDARD SOCKET SHOULDER SCREWS - PLAIN	CFM	286-09	6-39



**CALL - 1 (800) 723-2826**

# SOCKET HEAD CAP SCREW

PLAIN FINISH - MADE IN THE U.S.A.

Line: 253-00

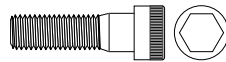

PART NUMBER	SIZE	QTY/BX	LIST PRICE
HYA00004	0/80 X 1/8	100	
HYA00006	0/80 X 3/16	100	
HYA00008	0/80 X 1/4	100	
HYA00012	0/80 X 3/8	100	
HYA11004	1/72 X 1/8	100	
HYA11006	1/72 X 3/16	100	
HYA11008	1/72 X 1/4	100	
HYA11012	1/72 X 3/8	100	
HYA22006	2/56 X 3/16	100	
HYA22008	2/56 X 1/4	100	
HYA22012	2/56 X 3/8	100	
HYA22016	2/56 X 1/2	100	
HYA33006	3/48 X 3/16	100	
HYA33008	3/48 X 1/4	100	
HYA33012	3/48 X 3/8	100	
HYA33016	3/48 X 1/2	100	
HYA44006	4/40 X 3/16	100	
HYA44008	4/40 X 1/4	100	
HYA44010	4/40 X 5/16	100	
HYA44012	4/40 X 3/8	100	
HYA44016	4/40 X 1/2	100	
HYA44020	4/40 X 5/8	100	
HYA44024	4/40 X 3/4	100	
HYA44028	4/40 X 7/8	100	
HYA44032	4/40 X 1	100	
HYA55008	5/40 X 1/4	100	
HYA55012	5/40 X 3/8	100	
HYA55016	5/40 X 1/2	100	
HYA55020	5/40 X 5/8	100	
HYA55024	5/40 X 3/4	100	
HYA55032X	5/40 X 1	100	
HYA66008	6/32 X 1/4	100	
HYA66012	6/32 X 3/8	100	
HYA66016	6/32 X 1/2	100	
HYA66020	6/32 X 5/8	100	
HYA66024	6/32 X 3/4	100	
HYA66028	6/32 X 7/8	100	
HYA66032	6/32 X 1	100	
HYA66040X	6/32 X 1 1/4	100	
HYA66048	6/32 X 1 1/2	100	
HYA66064	6/32 X 2	100	
HYA66080	6/32 X 2 1/2	100	
HYAS66008	6/40 X 1/4	100	
HYAS66012	6/40 X 3/8	100	
HYAS66016	6/40 X 1/2	100	
HYAS66020	6/40 X 5/8	100	

(continued...)

# SOCKET HEAD CAP SCREW (cont.)

PLAIN FINISH - MADE IN THE U.S.A.

Line: 253-00

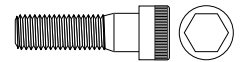

PART NUMBER	SIZE	QTY/BX	LIST PRICE
HYAS66024	6/40 X 3/4	100	
HYAS66028	6/40 X 7/8	100	
HYAS66032	6/40 X 1	100	
HYAS66040	6/40 X 1 1/4	100	
HYAS66048	6/40 X 1 1/2	100	
HYAS66064	6/40 X 2	100	
HYA88008	8/32 X 1/4	100	
HYA88012	8/32 X 3/8	100	
HYA88016	8/32 X 1/2	100	
HYA88020	8/32 X 5/8	100	
HYA88024	8/32 X 3/4	100	
HYA88028	8/32 X 7/8	100	
HYA88032	8/32 X 1	100	
HYA88040	8/32 X 1 1/4	100	
HYA88048	8/32 X 1 1/2	100	
HYA88064X	8/32 X 2	100	
HYA88080	8/32 X 2 1/2	100	
HYAS88012	8/36 X 3/8	100	
HYAS88016	8/36 X 1/2	100	
HYAS88024	8/36 X 3/4	100	
HYA03012	10/24 X 3/8	100	
HYA03016	10/24 X 1/2	100	
HYA03020	10/24 X 5/8	100	
HYA03024	10/24 X 3/4	100	
HYA03028	10/24 X 7/8	100	
HYA03032	10/24 X 1	100	
HYA03040	10/24 X 1 1/4	100	
HYA03048	10/24 X 1 1/2	100	
HYA03056	10/24 X 1 3/4	100	
HYA03064	10/24 X 2	100	
HYA03072	10/24 X 2 1/4	100	
HYA03080	10/24 X 2 1/2	100	
HYA03096	10/24 X 3	100	
HYAS03008	10/32 X 1/4	100	
HYAS03012	10/32 X 3/8	100	
HYAS03014X	10/32 X 7/16	100	
HYAS03016	10/32 X 1/2	100	
HYAS03020	10/32 X 5/8	100	
HYAS03024	10/32 X 3/4	100	
HYAS03028	10/32 X 7/8	100	
HYAS03032	10/32 X 1	100	
HYAS03040	10/32 X 1 1/4	100	
HYAS03048	10/32 X 1 1/2	100	
HYAS03056	10/32 X 1 3/4	100	
HYAS03064	10/32 X 2	100	
HYAS03072	10/32 X 2 1/4	100	

(continued...)

**SOCKET HEAD CAP SCREW (cont.)**

PLAIN FINISH - MADE IN THE U.S.A.

Line: 253-00

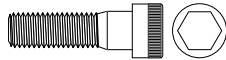

PART NUMBER	SIZE	QTY/BX	LIST PRICE
HYAS03080	10/32 X 2 1/2	100	
HYAS03096	10/32 X 3	100	
HYA04008	1/4-20 X 1/4	100	
HYA04012	1/4-20 X 3/8	100	
HYA04016	1/4-20 X 1/2	100	
HYA04020	1/4-20 X 5/8	100	
HYA04024	1/4-20 X 3/4	100	
HYA04028	1/4-20 X 7/8	100	
HYA04032	1/4-20 X 1	100	
HYA04040	1/4-20 X 1 1/4	100	
HYA04048	1/4-20 X 1 1/2	100	
HYA04056	1/4-20 X 1 3/4	100	
HYA04064	1/4-20 X 2	100	
HYA04072	1/4-20 X 2 1/4	100	
HYA04080	1/4-20 X 2 1/2	100	
HYA04088	1/4-20 X 2 3/4	100	
HYA04096	1/4-20 X 3	100	
HYA04104	1/4-20 X 3 1/4	100	
HYA04112	1/4-20 X 3 1/2	100	
HYA04120	1/4-20 X 3 3/4	100	
HYA04128	1/4-20 X 4	100	
HYAS04012	1/4-28 X 3/8	100	
HYAS04016	1/4-28 X 1/2	100	
HYAS04020	1/4-28 X 5/8	100	
HYAS04024	1/4-28 X 3/4	100	
HYAS04028	1/4-28 X 7/8	100	
HYAS04032	1/4-28 X 1	100	
HYAS04040	1/4-28 X 1 1/4	100	
HYAS04048	1/4-28 X 1 1/2	100	
HYAS04056	1/4-28 X 1 3/4	100	
HYAS04064	1/4-28 X 2	100	
HYAS04072	1/4-28 X 2 1/4	100	
HYA04104	1/4-28 X 3 1/4	25	
HYA05012	5/16-18 X 3/8	100	
HYA05016	5/16-18 X 1/2	100	
HYA05020	5/16-18 X 5/8	100	
HYA05024	5/16-18 X 3/4	100	
HYA05028	5/16-18 X 7/8	100	
HYA05032	5/16-18 X 1	100	
HYA05040	5/16-18 X 1 1/4	100	
HYA05048	5/16-18 X 1 1/2	100	
HYA05056	5/16-18 X 1 3/4	100	
HYA05064	5/16-18 X 2	100	
HYA05072	5/16-18 X 2 1/4	100	
HYA05080	5/16-18 X 2 1/2	100	
HYA05088	5/16-18 X 2 3/4	100	

(continued...)

**SOCKET HEAD CAP SCREW (cont.)**

PLAIN FINISH - MADE IN THE U.S.A.

Line: 253-00

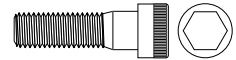

PART NUMBER	SIZE	QTY/BX	LIST PRICE
HYA05096	5/16-18 X 3	100	
HYA05104	5/16-18 X 3 1/4	100	
HYA05112	5/16-18 X 3 1/2	50	
HYA05128	5/16-18 X 4	100	
HYA05160X	5/16-18 X 5	100	
HYAS05016	5/16-24 X 1/2	100	
HYAS05020	5/16-24 X 5/8	100	
HYAS05024	5/16-24 X 3/4	100	
HYAS05028	5/16-24 X 7/8	100	
HYAS05032	5/16-24 X 1	100	
HYAS05040	5/16-24 X 1 1/4	100	
HYAS05048	5/16-24 X 1 1/2	100	
HYAS05056	5/16-24 X 1 3/4	100	
HYAS05064	5/16-24 X 2	100	
HYAS05072	5/16-24 X 2 1/4	100	
HYAS05080	5/16-24 X 2 1/2	100	
HYAS05088X	5/16-24 X 2 3/4	50	
HYA06016	3/8-16 X 1/2	100	
HYA06020	3/8-16 X 5/8	100	
HYA06024	3/8-16 X 3/4	100	
HYA06028	3/8-16 X 7/8	100	
HYA06032	3/8-16 X 1	100	
HYA06040	3/8-16 X 1 1/4	100	
HYA06048	3/8-16 X 1 1/2	100	
HYA06056	3/8-16 X 1 3/4	50	
HYA06064	3/8-16 X 2	50	
HYA06072	3/8-16 X 2 1/4	50	
HYA06080	3/8-16 X 2 1/2	50	
HYA06088	3/8-16 X 2 3/4	50	
HYA06096	3/8-16 X 3	50	
HYA06104	3/8-16 X 3 1/4	50	
HYA06112	3/8-16 X 3 1/2	50	
HYA06128	3/8-16 X 4	50	
HYA06144	3/8-16 X 4 1/2	50	
HYA06160	3/8-16 X 5	50	
HYA06176	3/8-16 X 5 1/2	50	
HYA06192X	3/8-16 X 6	50	
HYA06208	3/8-16 X 6 1/2	50	
HYA06256	3/8-16 X 8	25	
HYAS06016	3/8-24 X 1/2	100	
HYAS06020	3/8-24 X 5/8	100	
HYAS06024	3/8-24 X 3/4	100	
HYAS06028	3/8-24 X 7/8	100	
HYAS06032	3/8-24 X 1	100	
HYAS06040	3/8-24 X 1 1/4	100	
HYAS06048	3/8-24 X 1 1/2	100	

(continued...)

**SOCKET HEAD CAP SCREW (cont.)**

PLAIN FINISH - MADE IN THE U.S.A.

Line: 253-00

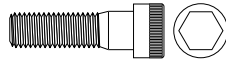

PART NUMBER	SIZE	QTY/BX	LIST PRICE
HYAS06056	3/8-24 X 1 3/4	50	
HYAS06064	3/8-24 X 2	50	
HYAS06072	3/8-24 X 2 1/4	100	
HYAS06080	3/8-24 X 2 1/2	50	
HYAS06096	3/8-24 X 3	50	
HYAS06112	3/8-24 X 3 1/2	50	
HYAS06160	3/8-24 X 5	25	
HYA07016	7/16-14 X 1/2	100	
HYA07020	7/16-14 X 5/8	100	
HYA07024	7/16-14 X 3/4	100	
HYA07028	7/16-14 X 7/8	100	
HYA07032	7/16-14 X 1	100	
HYA07040	7/16-14 X 1 1/4	100	
HYA07048	7/16-14 X 1 1/2	50	
HYA07056	7/16-14 X 1 3/4	50	
HYA07064	7/16-14 X 2	50	
HYA07072	7/16-14 X 2 1/4	50	
HYA07080	7/16-14 X 2 1/2	50	
HYA07088	7/16-14 X 2 3/4	25	
HYA07096	7/16-14 X 3	25	
HYA07104	7/16-14 X 3 1/4	25	
HYA07112	7/16-14 X 3 1/2	25	
HYA07128	7/16-14 X 4	25	
HYAS07032	7/16-20 X 1	100	
HYAS07040	7/16-20 X 1 1/4	50	
HYAS07048	7/16-20 X 1 1/2	50	
HYAS07064	7/16-20 X 2	50	
HYAS07096X	7/16-20 X 3	25	
HYA08016	1/2-13 X 1/2	50	
HYA08020	1/2-13 X 5/8	50	
HYA08024	1/2-13 X 3/4	50	
HYA08028	1/2-13 X 7/8	50	
HYA08032	1/2-13 X 1	50	
HYA08040	1/2-13 X 1 1/4	50	
HYA08048	1/2-13 X 1 1/2	50	
HYA08056	1/2-13 X 1 3/4	50	
HYA08064	1/2-13 X 2	50	
HYA08072	1/2-13 X 2 1/4	25	
HYA08080	1/2-13 X 2 1/2	25	
HYA08088	1/2-13 X 2 3/4	25	
HYA08096	1/2-13 X 3	25	
HYA08104	1/2-13 X 3 1/4	25	
HYA08112	1/2-13 X 3 1/2	25	
HYA08120	1/2-13 X 3 3/4	25	
HYA08128	1/2-13 X 4	25	
HYA08144	1/2-13 X 4 1/2	25	

(continued...)

**SOCKET HEAD CAP SCREW (cont.)**

PLAIN FINISH - MADE IN THE U.S.A.

Line: 253-00

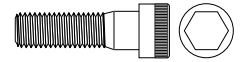

PART NUMBER	SIZE	QTY/BX	LIST PRICE
HYA08160	1/2-13 X 5	25	
HYA08176	1/2-13 X 5 1/2	25	
HYA08192	1/2-13 X 6	25	
HYA08208	1/2-13 X 6 1/2	10	
HYA08224	1/2-13 X 7	10	
HYA08256	1/2-13 X 8	10	
HYA08288	1/2-13 X 9	10	
HYA08320	1/2-13 X 10	10	
HYAS08032	1/2-20 X 1	50	
HYAS08040	1/2-20 X 1 1/4	50	
HYAS08048	1/2-20 X 1 1/2	50	
HYAS08056	1/2-20 X 1 3/4	25	
HYAS08064	1/2-20 X 2	50	
HYAS08072	1/2-20 X 2 1/4	25	
HYAS08080	1/2-20 X 2 1/2	25	
HYAS08088	1/2-20 X 2 3/4	25	
HYAS08096	1/2-20 X 3	25	
HYAS08112X	1/2-20 X 3 1/2	25	
HYA10032	5/8-11 X 1	50	
HYA10040	5/8-11 X 1 1/4	50	
HYA10048	5/8-11 X 1 1/2	25	
HYA10056	5/8-11 X 1 3/4	50	
HYA10064	5/8-11 X 2	25	
HYA10072	5/8-11 X 2 1/4	25	
HYA10080	5/8-11 X 2 1/2	25	
HYA10088	5/8-11 X 2 3/4	25	
HYA10096	5/8-11 X 3	25	
HYA10104	5/8-11 X 3 1/4	25	
HYA10112	5/8-11 X 3 1/2	25	
HYA10128	5/8-11 X 4	25	
HYA10144	5/8-11 X 4 1/2	25	
HYA10160	5/8-11 X 5	25	
HYA10176	5/8-11 X 5 1/2	10	
HYA10192	5/8-11 X 6	10	
HYA10208	5/8-11 X 6 1/2	10	
HYA10224	5/8-11 X 7	10	
HYA10240	5/8-11 X 7 1/2	10	
HYA10256	5/8-11 X 8	10	
HYA10320	5/8-11 X 10	5	
HYA10384	5/8-11 X 12	5	
HYAS10032	5/8-18 X 1	25	
HYAS10040	5/8-18 X 1 1/4	50	
HYAS10048	5/8-18 X 1 1/2	50	
HYAS10056	5/8-18 X 1 3/4	50	
HYAS10064	5/8-18 X 2	50	
HYAS10072X	5/8-18 X 2 1/4	25	

(continued...)

**SOCKET HEAD CAP SCREW (cont.)**

PLAIN FINISH - MADE IN THE U.S.A.

Line: 253-00

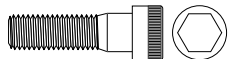

PART NUMBER	SIZE	QTY/BX	LIST PRICE
HYAS10080	5/8-18 X 2 1/2	25	
HYAS10088	5/8-18 X 2 3/4	25	
HYAS10096X	5/8-18 X 3	25	
HYAS10112	5/8-18 X 3 1/2	25	
HYAS10128	5/8-18 X 4	25	
HYA12040	3/4-10 X 1 1/4	25	
HYA12048	3/4-10 X 1 1/2	25	
HYA12056	3/4-10 X 1 3/4	25	
HYA12064	3/4-10 X 2	25	
HYA12072	3/4-10 X 2 1/4	25	
HYA12080	3/4-10 X 2 1/2	25	
HYA12088	3/4-10 X 2 3/4	25	
HYA12096	3/4-10 X 3	25	
HYA12104	3/4-10 X 3 1/4	25	
HYA12112	3/4-10 X 3 1/2	25	
HYA12120	3/4-10 X 3 3/4	25	
HYA12128	3/4-10 X 4	25	
HYA12144	3/4-10 X 4 1/2	25	
HYA12160	3/4-10 X 5	25	
HYA12176	3/4-10 X 5 1/2	10	
HYA12192	3/4-10 X 6	10	
HYA12208	3/4-10 X 6 1/2	10	
HYA12224	3/4-10 X 7	10	
HYA12256	3/4-10 X 8	10	
HYA12288	3/4-10 X 9	5	
HYA12320	3/4-10 X 10	5	
HYAS12128	3/4-16 X 4	25	
HYA14064	7/8-9 X 2	10	
HYA14072	7/8-9 X 2 1/4	10	
HYA14080	7/8-9 X 2 1/2	10	
HYA14088	7/8-9 X 2 3/4	10	
HYA14096	7/8-9 X 3	10	
HYA14104	7/8-9 X 3 1/4	10	
HYA14112	7/8-9 X 3 1/2	10	
HYA14128	7/8-9 X 4	10	
HYA14144	7/8-9 X 4 1/2	10	
HYA14160	7/8-9 X 5	10	
HYA14176	7/8-9 X 5 1/2	10	
HYA14192	7/8-9 X 6	10	
HYA14208	7/8-9 X 6 1/2	10	
HYA14224	7/8-9 X 7	10	
HYA14256	7/8-9 X 8	10	
HYA16064	1-8 X 2	10	
HYA16072	1-8 X 2 1/4	10	
HYA16080	1-8 X 2 1/2	10	
HYA16088	1-8 X 2 3/4	10	

(continued...)

**SOCKET HEAD CAP SCREW (cont.)**

PLAIN FINISH - MADE IN THE U.S.A.

Line: 253-00

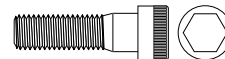

PART NUMBER	SIZE	QTY/BX	LIST PRICE
HYA16096	1-8 X 3	10	
HYA16104	1-8 X 3 1/4	10	
HYA16112	1-8 X 3 1/2	10	
HYA16128	1-8 X 4	10	
HYA16144	1-8 X 4 1/2	10	
HYA16160	1-8 X 5	10	
HYA16176	1-8 X 5 1/2	10	
HYA16192	1-8 X 6	10	
HYA16208	1-8 X 6 1/2	10	
HYA16224	1-8 X 7	10	
HYA16256	1-8 X 8	10	
HYAS16064X	1-14 X 2	25	
HYAS16096X	1-14 X 3	25	
HYAS16128X	1-14 X 4	10	
HYA20080	1 1/4-7 X 2 1/2	5	
HYA20096	1 1/4-7 X 3	1	
HYA20112	1 1/4-7 X 3 1/2	1	
HYA20128	1 1/4-7 X 4	1	
HYA20144	1 1/4-7 X 4 1/2	1	
HYA20160	1 1/4-7 X 5	1	
HYA20176	1 1/4-7 X 5 1/2	1	
HYA20192	1 1/4-7 X 6	1	
HYA20208	1 1/4-7 X 6 1/2	1	
HYA20224	1 1/4-7 X 7	1	
HYA20256	1 1/4-7 X 8	1	
HYA20288	1 1/4-7 X 9	1	
HYA20320	1 1/4-7 X 10	1	
HYA20384	1 1/4-7 X 12	1	
HYA24096	1 1/2-6 X 3	1	
HYA24112	1 1/2-6 X 3 1/2	1	
HYA24128	1 1/2-6 X 4	1	
HYA24144	1 1/2-6 X 4 1/2	1	
HYA24160	1 1/2-6 X 5	1	
HYA24176	1 1/2-6 X 5 1/2	1	
HYA24192	1 1/2-6 X 6	1	
HYA24208	1 1/2-6 X 6 1/2	1	
HYA24224	1 1/2-6 X 7	1	
HYA24256	1 1/2-6 X 8	1	
HYA24272	1 1/2-6 X 8 1/2	1	
HYA24288	1 1/2-6 X 9	1	
HYA24320	1 1/2-6 X 10	1	
HYA24384	1 1/2-6 X 12	1	



## FLAT SOCKET CAP SCREW

PLAIN FINISH - MADE IN THE U.S.A.

Line: 256-00

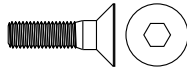

PART NUMBER	SIZE	QTY/BX	LIST PRICE
JCA44008	4/40 X 1/4	100	
JCA44012	4/40 X 3/8	100	
JCA44016	4/40 X 1/2	100	
JCA44020	4/40 X 5/8	100	
JCA44024	4/40 X 3/4	100	
JCA55008	5/40 X 1/4	100	
JCA55012	5/40 X 3/8	100	
JCA55016	5/40 X 1/2	100	
JCA55020	5/40 X 5/8	100	
JCA55024	5/40 X 3/4	100	
JCA66008	6/32 X 1/4	100	
JCA66012	6/32 X 3/8	100	
JCA66016	6/32 X 1/2	100	
JCA66020	6/32 X 5/8	100	
JCA66024	6/32 X 3/4	100	
JCA88012	8/32 X 3/8	100	
JCA88016	8/32 X 1/2	100	
JCA88020	8/32 X 5/8	100	
JCA88024	8/32 X 3/4	100	
JCA88032	8/32 X 1	100	
JCA03012	10/24 X 3/8	100	
JCA03016	10/24 X 1/2	100	
JCA03020	10/24 X 5/8	100	
JCA03024	10/24 X 3/4	100	
JCA03032	10/24 X 1	100	
JCA03040	10/24 X 1 1/4	100	
JCA03048	10/24 X 1 1/2	100	
JCAS03012	10/32 X 3/8	100	
JCAS03016	10/32 X 1/2	100	
JCAS03020	10/32 X 5/8	100	
JCAS03024	10/32 X 3/4	100	
JCAS03032	10/32 X 1	100	
JCAS03040	10/32 X 1 1/4	100	
JCAS03048	10/32 X 1 1/2	100	
JCA04012	1/4-20 X 3/8	100	
JCA04016	1/4-20 X 1/2	100	
JCA04020	1/4-20 X 5/8	100	
JCA04024	1/4-20 X 3/4	100	
JCA04028X	1/4-20 X 7/8	100	
JCA04032	1/4-20 X 1	100	
JCA04040	1/4-20 X 1 1/4	100	
JCA04048	1/4-20 X 1 1/2	100	
JCA04056	1/4-20 X 1 3/4	100	
JCA04064	1/4-20 X 2	100	
JCA04080X	1/4-20 X 2 1/2	100	
JCAS04012	1/4-28 X 3/8	100	

(continued...)

## FLAT SOCKET CAP SCREW (cont.)

PLAIN FINISH - MADE IN THE U.S.A.

Line: 256-00

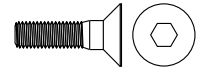

PART NUMBER	SIZE	QTY/BX	LIST PRICE
JCAS04016	1/4-28 X 1/2	100	
JCAS04020	1/4-28 X 5/8	100	
JCAS04024	1/4-28 X 3/4	100	
JCAS04032	1/4-28 X 1	100	
JCAS04040	1/4-28 X 1 1/4	100	
JCAS04048	1/4-28 X 1 1/2	100	
JCA05016	5/16-18 X 1/2	100	
JCA05020	5/16-18 X 5/8	100	
JCA05024	5/16-18 X 3/4	100	
JCA05032	5/16-18 X 1	100	
JCA05040	5/16-18 X 1 1/4	100	
JCA05048	5/16-18 X 1 1/2	100	
JCA05056	5/16-18 X 1 3/4	100	
JCA05064	5/16-18 X 2	100	
JCA05072	5/16-18 X 2 1/4	100	
JCA05080	5/16-18 X 2 1/2	100	
JCAS05016	5/16-24 X 1/2	100	
JCAS05020	5/16-24 X 5/8	100	
JCAS05024	5/16-24 X 3/4	100	
JCAS05032	5/16-24 X 1	100	
JCAS05040	5/16-24 X 1 1/4	100	
JCAS05048	5/16-24 X 1 1/2	100	
JCA06016	3/8-16 X 1/2	100	
JCA06020	3/8-16 X 5/8	100	
JCA06024	3/8-16 X 3/4	100	
JCA06032	3/8-16 X 1	100	
JCA06040	3/8-16 X 1 1/4	100	
JCA06048	3/8-16 X 1 1/2	100	
JCA06056	3/8-16 X 1 3/4	100	
JCA06064	3/8-16 X 2	50	
JCA06072	3/8-16 X 2 1/4	50	
JCA06080	3/8-16 X 2 1/2	50	
JCA06088X	3/8-16 X 2 3/4	50	
JCA06096	3/8-16 X 3	50	
JCAS06016X	3/8-24 X 1/2	100	
JCAS06020	3/8-24 X 5/8	100	
JCAS06024	3/8-24 X 3/4	100	
JCAS06028X	3/8-24 X 7/8	100	
JCAS06032	3/8-24 X 1	100	
JCAS06040	3/8-24 X 1 1/4	100	
JCAS06048	3/8-24 X 1 1/2	100	
JCA07020X	7/16-14 X 5/8	100	
JCA07024	7/16-14 X 3/4	100	
JCA07032	7/16-14 X 1	100	
JCA07040	7/16-14 X 1 1/4	50	
JCA07048	7/16-14 X 1 1/2	100	

(continued...)

## FLAT SOCKET CAP SCREW (cont.)

PLAIN FINISH - MADE IN THE U.S.A.

Line: 256-00

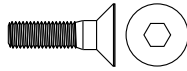

PART NUMBER	SIZE	QTY/BX	LIST PRICE
JCA07064X	7/16-14 X 2	50	
JCA08024	1/2-13 X 3/4	100	
JCA08032	1/2-13 X 1	100	
JCA08040	1/2-13 X 1 1/4	100	
JCA08048	1/2-13 X 1 1/2	50	
JCA08056	1/2-13 X 1 3/4	50	
JCA08064	1/2-13 X 2	50	
JCA08072	1/2-13 X 2 1/4	25	
JCA08080	1/2-13 X 2 1/2	25	
JCA08096	1/2-13 X 3	25	
JCAS08016X	1/2-20 X 1/2	50	
JCAS08024X	1/2-20 X 3/4	100	
JCAS08032	1/2-20 X 1	100	
JCAS08040	1/2-20 X 1 1/4	100	
JCAS08048	1/2-20 X 1 1/2	100	
JCAS08056	1/2-20 X 1 3/4	50	
JCAS08064	1/2-20 X 2	50	
JCA10040	5/8-11 X 1 1/4	25	
JCA10048	5/8-11 X 1 1/2	25	
JCA10056	5/8-11 X 1 3/4	25	
JCA10064	5/8-11 X 2	25	
JCA10072	5/8-11 X 2 1/4	25	
JCA10080	5/8-11 X 2 1/2	25	
JCA10096	5/8-11 X 3	25	
JCA12040	3/4-10 X 1 1/4	25	
JCA12048	3/4-10 X 1 1/2	25	
JCA12056	3/4-10 X 1 3/4	25	
JCA12064	3/4-10 X 2	25	
JCA12072	3/4-10 X 2 1/4	25	
JCA12080	3/4-10 X 2 1/2	25	
JCA12096	3/4-10 X 3	25	

## BUTTON SOCKET CAP SCREW

PLAIN FINISH - MADE IN THE U.S.A.

Line: 260-00

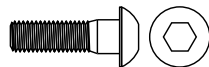

PART NUMBER	SIZE	QTY/BX	LIST PRICE
JGA44004	4/40 X 1/8	100	
JGA44006X	4/40 X 3/16	100	
JGA44008	4/40 X 1/4	100	
JGA44012	4/40 X 3/8	100	
JGA44016	4/40 X 1/2	100	
JGA44020	4/40 X 5/8	100	
JGA66008	6/32 X 1/4	100	
JGA66012	6/32 X 3/8	100	
JGA66016	6/32 X 1/2	100	
JGA66020	6/32 X 5/8	100	

(continued...)

## BUTTON SOCKET CAP SCREW (cont.)

PLAIN FINISH - MADE IN THE U.S.A.

Line: 260-00

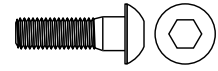

PART NUMBER	SIZE	QTY/BX	LIST PRICE
JGA88008X	8/32 X 1/4	100	
JGA88012	8/32 X 3/8	100	
JGA88016	8/32 X 1/2	100	
JGA88020	8/32 X 5/8	100	
JGA88024	8/32 X 3/4	100	
JGA88032	8/32 X 1	100	
JGA03008	10/24 X 1/4	100	
JGA03012	10/24 X 3/8	100	
JGA03016	10/24 X 1/2	100	
JGA03020	10/24 X 5/8	100	
JGA03024	10/24 X 3/4	100	
JGA03028	10/24 X 7/8	100	
JGA03032	10/24 X 1	100	
JGAS03008	10/32 X 1/4	100	
JGAS03012	10/32 X 3/8	100	
JGAS03016	10/32 X 1/2	100	
JGAS03020	10/32 X 5/8	100	
JGAS03024	10/32 X 3/4	100	
JGAS03028	10/32 X 7/8	100	
JGAS03032	10/32 X 1	100	
JGA04012	1/4-20 X 3/8	100	
JGA04016	1/4-20 X 1/2	100	
JGA04020	1/4-20 X 5/8	100	
JGA04024	1/4-20 X 3/4	100	
JGA04028	1/4-20 X 7/8	100	
JGA04032	1/4-20 X 1	100	
JGA04040	1/4-20 X 1 1/4	100	
JGAS04012	1/4-28 X 3/8	100	
JGAS04016	1/4-28 X 1/2	100	
JGAS04020	1/4-28 X 5/8	100	
JGAS04024	1/4-28 X 3/4	100	
JGAS04032	1/4-28 X 1	100	
JGA05012X	5/16-18 X 3/8	100	
JGA05016	5/16-18 X 1/2	100	
JGA05020	5/16-18 X 5/8	100	
JGA05024	5/16-18 X 3/4	100	
JGA05028	5/16-18 X 7/8	50	
JGA05032	5/16-18 X 1	100	
JGA05048	5/16-18 X 1 1/2	100	
JGAS05012	5/16-24 X 3/8	100	
JGAS05016	5/16-24 X 1/2	100	
JGAS05020	5/16-24 X 5/8	100	
JGAS05024	5/16-24 X 3/4	100	
JGAS05032	5/16-24 X 1	100	
JGA06016	3/8-16 X 1/2	100	
JGA06020	3/8-16 X 5/8	100	

(continued...)

## BUTTON SOCKET CAP SCREW (cont.)

PLAIN FINISH - MADE IN THE U.S.A.

Line: 260-00

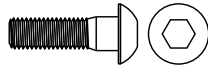

PART NUMBER	SIZE	QTY/BX	LIST PRICE
JGA06024	3/8-16 X 3/4	100	
JGA06028	3/8-16 X 7/8	100	
JGA06032	3/8-16 X 1	100	
JGA06040	3/8-16 X 1 1/4	100	
JGA06048	3/8-16 X 1 1/2	100	
JGAS06016	3/8-24 X 1/2	100	
JGAS06020	3/8-24 X 5/8	50	
JGAS06024X	3/8-24 X 3/4	100	
JGAS06032	3/8-24 X 1	100	
JGAS06040X	3/8-24 X 1 1/4	50	
JGA08032	1/2-13 X 1	50	
JGA08040	1/2-13 X 1 1/4	50	
JGA08048	1/2-13 X 1 1/2	50	
JGA08064	1/2-13 X 2	50	
JGA10040	5/8-11 X 1 1/4	25	
JGA10048	5/8-11 X 1 1/2	25	
JGA10064	5/8-11 X 2	25	

## LOW HEAD SOCKET CAP SCREW

PLAIN FINISH - MADE IN THE U.S.A.

Line: 263-00

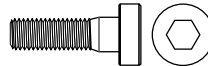

PART NUMBER	SIZE	QTY/BX	LIST PRICE
JLA88020	8-32 X 5/8	100	
JLA88012	8/32 X 3/8	100	
JLA88016	8/32 X 1/2	100	
JLA88024	8/32 X 3/4	100	
JLA88032	8/32 X 1	100	
JLA03012	10/24 X 3/8	100	
JLA03016	10/24 X 1/2	100	
JLA03020	10/24 X 5/8	100	
JLA03024	10/24 X 3/4	100	
JLA03032	10/24 X 1	100	
JLAS03012	10/32 X 3/8	100	
JLAS03016	10/32 X 1/2	100	
JLAS03020	10/32 X 5/8	100	
JLAS03024	10/32 X 3/4	100	
JLA04012	1/4-20 X 3/8	100	
JLA04016	1/4-20 X 1/2	100	
JLA04020	1/4-20 X 5/8	100	
JLA04024	1/4-20 X 3/4	100	
JLA04032	1/4-20 X 1	100	
JLA05016	5/16-18 X 1/2	100	
JLA05024	5/16-18 X 3/4	100	
JLA05032	5/16-18 X 1	100	
JLA05040	5/16-18 X 1 1/4	100	
JLA05048	5/16-18 X 1 1/2	100	

(continued...)

## LOW HEAD SOCKET CAP SCREW (cont.)

PLAIN FINISH - MADE IN THE U.S.A.

Line: 263-00

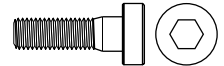

PART NUMBER	SIZE	QTY/BX	LIST PRICE
JLA06016	3/8-16 X 1/2	100	
JLA06024	3/8-16 X 3/4	100	
JLA06032	3/8-16 X 1	100	
JLA06040	3/8-16 X 1 1/4	100	
JLA06048	3/8-16 X 1 1/2	100	
JLA08032	1/2-13 X 1	50	
JLA08040	1/2-13 X 1 1/4	50	
JLA08048	1/2-13 X 1 1/2	50	

## SOCKET SET SCREW - CUP POINT

PLAIN FINISH - MADE IN THE U.S.A.

Line: 264-00

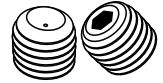

PART NUMBER	SIZE	QTY/BX	LIST PRICE
JMA00002	0/80 X 1/16	100	
JMA00003	0/80 X 3/32	100	
JMA00004	0/80 X 1/8	100	
JMA00006	0/80 X 3/16	100	
JMA00008	0/80 X 1/4	100	
JMA11002	1/72 X 1/16	100	
JMA11003	1/72 X 3/32	100	
JMA11004	1/72 X 1/8	100	
JMA11006	1/72 X 3/16	100	
JMA11008	1/72 X 1/4	100	
JMA22002	2/56 X 1/16	100	
JMA22003	2/56 X 3/32	100	
JMA22004	2/56 X 1/8	100	
JMA22006	2/56 X 3/16	100	
JMA22008	2/56 X 1/4	100	
JMA33003	3/48 X 3/32	100	
JMA33004	3/48 X 1/8	100	
JMA33006	3/48 X 3/16	100	
JMA33008	3/48 X 1/4	100	
JMA44004	4/40 X 1/8	100	
JMA44006	4/40 X 3/16	100	
JMA44008	4/40 X 1/4	100	
JMA44010	4/40 X 5/16	100	
JMA44012	4/40 X 3/8	100	
JMA44016	4/40 X 1/2	100	
JMA44020	4/40 X 5/8	100	
JMAS44004	4/48 X 1/8	100	
JMAS44006	4/48 X 3/16	100	
JMAS44008	4/48 X 1/4	100	
JMA55004	5/40 X 1/8	100	
JMA55006	5/40 X 3/16	100	
JMA55008	5/40 X 1/4	100	
JMA55010	5/40 X 5/16	100	

(continued...)

**SOCKET SET SCREW - CUP POINT** (cont.)

PLAIN FINISH - MADE IN THE U.S.A.

Line: 264-00

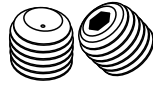

PART NUMBER	SIZE	QTY/BX	LIST PRICE
JMA55012	5/40 X 3/8	100	
JMA55016	5/40 X 1/2	100	
JMA55020	5/40 X 5/8	100	
JMA55024	5/40 X 3/4	100	
JMA55004	5/44 X 1/8	100	
JMA66004	6/32 X 1/8	100	
JMA66006	6/32 X 3/16	100	
JMA66008	6/32 X 1/4	100	
JMA66010	6/32 X 5/16	100	
JMA66012	6/32 X 3/8	100	
JMA66014	6/32 X 7/16	100	
JMA66016	6/32 X 1/2	100	
JMA66020	6/32 X 5/8	100	
JMA66024	6/32 X 3/4	100	
JMA66028	6/32 X 7/8	100	
JMA66032	6/32 X 1	100	
JMA566004	6/40 X 1/8	100	
JMA566006	6/40 X 3/16	100	
JMA566008	6/40 X 1/4	100	
JMA566012	6/40 X 3/8	100	
JMA88004	8/32 X 1/8	100	
JMA88006	8/32 X 3/16	100	
JMA88008	8/32 X 1/4	100	
JMA88010	8/32 X 5/16	100	
JMA88012	8/32 X 3/8	100	
JMA88016	8/32 X 1/2	100	
JMA88020	8/32 X 5/8	100	
JMA88024	8/32 X 3/4	100	
JMA88028	8/32 X 7/8	100	
JMA88032	8/32 X 1	100	
JMA588004	8/36 X 1/8	100	
JMA588006	8/36 X 3/16	100	
JMA588008	8/36 X 1/4	100	
JMA588010	8/36 X 5/16	100	
JMA588012	8/36 X 3/8	100	
JMA03006	10/24 X 3/16	100	
JMA03008	10/24 X 1/4	100	
JMA03010	10/24 X 5/16	100	
JMA03012	10/24 X 3/8	100	
JMA03014	10/24 X 7/16	100	
JMA03016	10/24 X 1/2	100	
JMA03020	10/24 X 5/8	100	
JMA03024	10/24 X 3/4	100	
JMA03028	10/24 X 7/8	100	
JMA03032	10/24 X 1	100	
JMA03040	10/24 X 1 1/4	100	

(continued...)

**SOCKET SET SCREW - CUP POINT** (cont.)

PLAIN FINISH - MADE IN THE U.S.A.

Line: 264-00

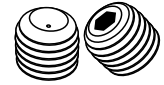

PART NUMBER	SIZE	QTY/BX	LIST PRICE
JMAS03006	10/32 X 3/16	100	
JMAS03008	10/32 X 1/4	100	
JMAS03010	10/32 X 5/16	100	
JMAS03012	10/32 X 3/8	100	
JMAS03014	10/32 X 7/16	100	
JMAS03016	10/32 X 1/2	100	
JMAS03020	10/32 X 5/8	100	
JMAS03024	10/32 X 3/4	100	
JMAS03028	10/32 X 7/8	100	
JMAS03032	10/32 X 1	100	
JMAS03040	10/32 X 1 1/4	100	
JMA04006	1/4-20 X 3/16	100	
JMA04008	1/4-20 X 1/4	100	
JMA04010	1/4-20 X 5/16	100	
JMA04012	1/4-20 X 3/8	100	
JMA04014	1/4-20 X 7/16	100	
JMA04016	1/4-20 X 1/2	100	
JMA04020	1/4-20 X 5/8	100	
JMA04024	1/4-20 X 3/4	100	
JMA04028	1/4-20 X 7/8	100	
JMA04032	1/4-20 X 1	100	
JMA04040	1/4-20 X 1 1/4	100	
JMA04048	1/4-20 X 1 1/2	100	
JMA04056	1/4-20 X 1 3/4	100	
JMA04064	1/4-20 X 2	100	
JMAS04006	1/4-28 X 3/16	100	
JMAS04008	1/4-28 X 1/4	100	
JMAS04010	1/4-28 X 5/16	100	
JMAS04012	1/4-28 X 3/8	100	
JMAS04016	1/4-28 X 1/2	100	
JMAS04020	1/4-28 X 5/8	100	
JMAS04024	1/4-28 X 3/4	100	
JMAS04032	1/4-28 X 1	100	
JMAS04040	1/4-28 X 1 1/4	100	
JMA05008	5/16-18 X 1/4	100	
JMA05010	5/16-18 X 5/16	100	
JMA05012	5/16-18 X 3/8	100	
JMA05014	5/16-18 X 7/16	100	
JMA05016	5/16-18 X 1/2	100	
JMA05020	5/16-18 X 5/8	100	
JMA05024	5/16-18 X 3/4	100	
JMA05028	5/16-18 X 7/8	100	
JMA05032	5/16-18 X 1	100	
JMA05040	5/16-18 X 1 1/4	100	
JMA05048	5/16-18 X 1 1/2	100	
JMA05056	5/16-18 X 1 3/4	100	

(continued...)

**SOCKET SET SCREW - CUP POINT (cont.)**

PLAIN FINISH - MADE IN THE U.S.A.

Line: 264-00

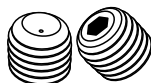

PART NUMBER	SIZE	QTY/BX	LIST PRICE
JMA05064	5/16-18 X 2	100	
JMA05096X	5/16-18 X 3	100	
JMAS05008	5/16-24 X 1/4	100	
JMAS05010	5/16-24 X 5/16	100	
JMAS05012	5/16-24 X 3/8	100	
JMAS05014X	5/16-24 X 7/16	100	
JMAS05016	5/16-24 X 1/2	100	
JMAS05020	5/16-24 X 5/8	100	
JMAS05024	5/16-24 X 3/4	100	
JMAS05032	5/16-24 X 1	100	
JMA06008	3/8-16 X 1/4	100	
JMA06010	3/8-16 X 5/16	100	
JMA06012	3/8-16 X 3/8	100	
JMA06014	3/8-16 X 7/16	100	
JMA06016	3/8-16 X 1/2	100	
JMA06020	3/8-16 X 5/8	100	
JMA06024	3/8-16 X 3/4	100	
JMA06028	3/8-16 X 7/8	100	
JMA06032	3/8-16 X 1	100	
JMA06040	3/8-16 X 1 1/4	100	
JMA06048	3/8-16 X 1 1/2	100	
JMA06056	3/8-16 X 1 3/4	100	
JMA06064	3/8-16 X 2	100	
JMA06080	3/8-16 X 2 1/2	100	
JMAS06008	3/8-24 X 1/4	100	
JMAS06010X	3/8-24 X 5/16	100	
JMAS06012	3/8-24 X 3/8	100	
JMAS06016	3/8-24 X 1/2	100	
JMAS06020	3/8-24 X 5/8	100	
JMAS06024	3/8-24 X 3/4	100	
JMAS06032	3/8-24 X 1	100	
JMAS06040	3/8-24 X 1 1/4	100	
JMAS06048	3/8-24 X 1 1/2	100	
JMAS06080X	3/8-24 X 2 1/2	100	
JMA07012	7/16-14 X 3/8	100	
JMA07014	7/16-14 X 7/16	100	
JMA07016	7/16-14 X 1/2	100	
JMA07020	7/16-14 X 5/8	100	
JMA07024	7/16-14 X 3/4	100	
JMA07028	7/16-14 X 7/8	50	
JMA07032	7/16-14 X 1	100	
JMA07040	7/16-14 X 1 1/4	100	
JMA07048	7/16-14 X 1 1/2	100	
JMA07056	7/16-14 X 1 3/4	50	
JMA07064	7/16-14 X 2	100	
JMAS07012	7/16-20 X 3/8	100	

(continued...)

**SOCKET SET SCREW - CUP POINT (cont.)**

PLAIN FINISH - MADE IN THE U.S.A.

Line: 264-00

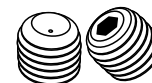

PART NUMBER	SIZE	QTY/BX	LIST PRICE
JMAS07014	7/16-20 X 7/16	100	
JMAS07016	7/16-20 X 1/2	100	
JMA08012	1/2-13 X 3/8	100	
JMA08016	1/2-13 X 1/2	100	
JMA08020	1/2-13 X 5/8	100	
JMA08024	1/2-13 X 3/4	100	
JMA08028	1/2-13 X 7/8	100	
JMA08032	1/2-13 X 1	100	
JMA08040	1/2-13 X 1 1/4	100	
JMA08048	1/2-13 X 1 1/2	100	
JMA08056	1/2-13 X 1 3/4	50	
JMA08064	1/2-13 X 2	50	
JMA08080	1/2-13 X 2 1/2	50	
JMA08096	1/2-13 X 3	50	
JMAS08016	1/2-20 X 1/2	100	
JMAS08020X	1/2-20 X 5/8	100	
JMAS08024	1/2-20 X 3/4	100	
JMAS08032	1/2-20 X 1	100	
JMA10016	5/8-11 X 1/2	100	
JMA10020	5/8-11 X 5/8	50	
JMA10024	5/8-11 X 3/4	50	
JMA10028	5/8-11 X 7/8	50	
JMA10032	5/8-11 X 1	50	
JMA10040	5/8-11 X 1 1/4	50	
JMA10048	5/8-11 X 1 1/2	50	
JMA10056	5/8-11 X 1 3/4	50	
JMA10064	5/8-11 X 2	25	
JMA10080	5/8-11 X 2 1/2	25	
JMA10096	5/8-11 X 3	50	
JMAS10016	5/8-18 X 1/2	100	
JMAS10020	5/8-18 X 5/8	50	
JMAS10032	5/8-18 X 1	50	
JMA12020	3/4-10 X 5/8	50	
JMA12024	3/4-10 X 3/4	50	
JMA12032	3/4-10 X 1	50	
JMA12040	3/4-10 X 1 1/4	50	
JMA12048	3/4-10 X 1 1/2	25	
JMA12056	3/4-10 X 1 3/4	50	
JMA12064	3/4-10 X 2	25	
JMA12080	3/4-10 X 2 1/2	10	
JMA12096	3/4-10 X 3	25	
JMA14028	7/8-9 X 7/8	10	
JMA14032	7/8-9 X 1	25	
JMA14048	7/8-9 X 1 1/2	25	
JMA14056X	7/8-9 X 1 3/4	10	
JMA14064	7/8-9 X 2	10	

(continued...)

## SOCKET SET SCREW - CUP POINT (cont.)

PLAIN FINISH - MADE IN THE U.S.A.

Line: 264-00

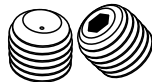

PART NUMBER	SIZE	QTY/BX	LIST PRICE
JMA14080	7/8-9 X 2 1/2	10	
JMA14096	7/8-9 X 3	10	
JMA16032	1-8 X 1	25	
JMA16048	1-8 X 1 1/2	25	
JMA16056	1-8 X 1 3/4	10	
JMA16064	1-8 X 2	25	
JMA16080	1-8 X 2 1/2	10	
JMA16096	1-8 X 3	10	

## SOCKET SET SCREW - CUP POINT

ZINC PLATED

Line: 265-00

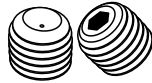

PART NUMBER	SIZE	QTY/BX	LIST PRICE
JNA44006	4/40 X 3/16	100	
JNA55012	5/40 X 3/8	100	
JNA55016	5/40 X 1/2	100	
JNA66006	6/32 X 3/16	100	
JNA66008	6/32 X 1/4	100	
JNA66032	6/32 X 1	100	
JNA88016	8/32 X 1/2	100	
JNA88024	8/32 X 3/4	100	
JNAS88004	8/36 X 1/8	100	
JNA03008	10/24 X 1/4	100	
JNA03010	10/24 X 5/16	100	
JNA03012	10/24 X 3/8	100	
JNA03020	10/24 X 5/8	100	
JNA03024	10/24 X 3/4	100	
JNA03032	10/24 X 1	100	
JNAS03008	10/32 X 1/4	100	
JNAS03016	10/32 X 1/2	100	
JNAS03020	10/32 X 5/8	100	
JNAS03032	10/32 X 1	100	
JNA04012	1/4-20 X 3/8	100	
JNA04020	1/4-20 X 5/8	100	
JNA04040	1/4-20 X 1 1/4	100	
JNAS04016	1/4-28 X 1/2	100	
JNA05040	5/16-18 X 1 1/4	100	
JNA05048	5/16-18 X 1 1/2	100	
JNA06010	3/8-16 X 5/16	100	
JNA06012	3/8-16 X 3/8	100	
JNA06020	3/8-16 X 5/8	100	
JNA06032	3/8-16 X 1	100	
JNA06064	3/8-16 X 2	50	
JNAS06008	3/8-24 X 1/4	100	
JNA08016	1/2-13 X 1/2	100	
JNA08020	1/2-13 X 5/8	100	

(continued...)

## SOCKET SET SCREW - CUP POINT (cont.)

ZINC PLATED

Line: 265-00

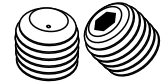

PART NUMBER	SIZE	QTY/BX	LIST PRICE
JNA08048	1/2-13 X 1 1/2	50	
JNA10016	5/8-11 X 1/2	100	
JNA12064	3/4-10 X 2	10	

## SOCKET SET SCREW FLAT POINT

PLAIN FINISH

Line: 267-00

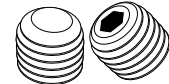

PART NUMBER	SIZE	QTY/BX	LIST PRICE
JSA44004	4/40 X 1/8	100	
JSA44006	4/40 X 3/16	100	
JSA44008	4/40 X 1/4	100	
JSA44010	4/40 X 5/16	100	
JSA55004	5/40 X 1/8	100	
JSA55006	5/40 X 3/16	100	
JSA55008	5/40 X 1/4	100	
JSA66004	6/32 X 1/8	100	
JSA66006	6/32 X 3/16	100	
JSA66008	6/32 X 1/4	100	
JSA66010	6/32 X 5/16	100	
JSA66012	6/32 X 3/8	100	
JSA88004	8/32 X 1/8	100	
JSA88006	8/32 X 3/16	100	
JSA88008	8/32 X 1/4	100	
JSA88010	8/32 X 5/16	100	
JSA88012	8/32 X 3/8	100	
JSA88016	8/32 X 1/2	100	
JSA88020	8/32 X 5/8	100	
JSA03006	10/24 X 3/16	100	
JSA03008	10/24 X 1/4	100	
JSA03010	10/24 X 5/16	100	
JSA03012	10/24 X 3/8	100	
JSA03014	10/24 X 7/16	100	
JSA03016	10/24 X 1/2	100	
JSA03020	10/24 X 5/8	100	
JSA03024	10/24 X 3/4	100	
JSA03032	10/24 X 1	100	
JSA03006	10/32 X 3/16	100	
JSA03008	10/32 X 1/4	100	
JSA03010	10/32 X 5/16	100	
JSA03012	10/32 X 3/8	100	
JSA03016	10/32 X 1/2	100	
JSA04006	1/4-20 X 3/16	100	
JSA04008	1/4-20 X 1/4	100	
JSA04010	1/4-20 X 5/16	100	
JSA04012	1/4-20 X 3/8	100	
JSA04016	1/4-20 X 1/2	100	

(continued...)

**SOCKET SET SCREW FLAT POINT (cont.)**

PLAIN FINISH

Line: 267-00

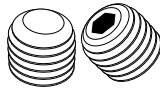

PART NUMBER	SIZE	QTY/BX	LIST PRICE
JSA04020	1/4-20 X 5/8	100	
JSA04024	1/4-20 X 3/4	100	
JSA04032	1/4-20 X 1	100	
JSA504008	1/4-28 X 1/4	100	
JSA504012	1/4-28 X 3/8	100	
JSA05008	5/16-18 X 1/4	100	
JSA05010	5/16-18 X 5/16	100	
JSA05012	5/16-18 X 3/8	100	
JSA05016	5/16-18 X 1/2	100	
JSA05020	5/16-18 X 5/8	100	
JSA05024	5/16-18 X 3/4	100	
JSA05032	5/16-18 X 1	100	
JSA505010	5/16-24 X 5/16	100	
JSA505012	5/16-24 X 3/8	100	
JSA06008	3/8-16 X 1/4	100	
JSA06010X	3/8-16 X 5/16	100	
JSA06012	3/8-16 X 3/8	100	
JSA06016	3/8-16 X 1/2	100	
JSA06020	3/8-16 X 5/8	100	
JSA06024	3/8-16 X 3/4	100	
JSA06032	3/8-16 X 1	100	
JSA506012	3/8-24 X 3/8	100	
JSA506016	3/8-24 X 1/2	100	
JSA07008X	7/16-14 X 1/4	100	
JSA08012	1/2-13 X 3/8	100	
JSA08016	1/2-13 X 1/2	100	
JSA08020	1/2-13 X 5/8	100	
JSA08024	1/2-13 X 3/4	100	
JSA08032	1/2-13 X 1	100	
JSA508016	1/2-20 X 1/2	100	
JSA10020	5/8-11 X 5/8	50	
JSA10080X	5/8-11 X 2 1/2	10	
JSA12032X	3/4-10 X 1	25	

**SOCKET SET SCREW - CONE POINT**

PLAIN FINISH

Line: 268-00

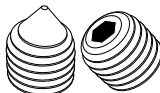

PART NUMBER	SIZE	QTY/BX	LIST PRICE
JTA44004	4/40 X 1/8	100	
JTA44006	4/40 X 3/16	100	
JTA44008	4/40 X 1/4	100	
JTA55006	5/40 X 3/16	100	
JTA55008	5/40 X 1/4	100	
JTA66004	6/32 X 1/8	100	
JTA66006	6/32 X 3/16	100	
JTA66008	6/32 X 1/4	100	

(continued...)

**SOCKET SET SCREW CONE POINT (cont.)**

PLAIN FINISH

Line: 268-00

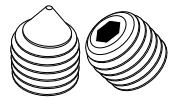

PART NUMBER	SIZE	QTY/BX	LIST PRICE
JTA66010X	6/32 X 5/16	100	
JTA66012X	6/32 X 3/8	100	
JTA66016X	6/32 X 1/2	100	
JTA88006	8/32 X 3/16	100	
JTA88008	8/32 X 1/4	100	
JTA88010	8/32 X 5/16	100	
JTA88012	8/32 X 3/8	100	
JTA88016	8/32 X 1/2	100	
JTA03006	10/24 X 3/16	100	
JTA03008	10/24 X 1/4	100	
JTA03010X	10/24 X 5/16	100	
JTA03012	10/24 X 3/8	100	
JTA03016	10/24 X 1/2	100	
JTA503006	10/32 X 3/16	100	
JTA503008	10/32 X 1/4	100	
JTA503012	10/32 X 3/8	100	
JTA04008	1/4-20 X 1/4	100	
JTA04010	1/4-20 X 5/16	100	
JTA04012	1/4-20 X 3/8	100	
JTA04016	1/4-20 X 1/2	100	
JTA04020	1/4-20 X 5/8	100	
JTA04024	1/4-20 X 3/4	100	
JTA04032	1/4-20 X 1	100	
JTA504008	1/4-28 X 1/4	100	
JTA504012	1/4-28 X 3/8	100	
JTA05010	5/16-18 X 5/16	100	
JTA05012	5/16-18 X 3/8	100	
JTA05016	5/16-18 X 1/2	100	
JTA05020	5/16-18 X 5/8	100	
JTA05024	5/16-18 X 3/4	100	
JTA05032	5/16-18 X 1	100	
JTA505008X	5/16-24 X 1/4	100	
JTA505012	5/16-24 X 3/8	100	
JTA505016	5/16-24 X 1/2	100	
JTA505020	5/16-24 X 5/8	100	
JTA06012	3/8-16 X 3/8	100	
JTA06016	3/8-16 X 1/2	100	
JTA06020	3/8-16 X 5/8	100	
JTA06024	3/8-16 X 3/4	100	
JTA06032	3/8-16 X 1	100	
JTA08016X	1/2-13 X 1/2	100	
JTA08020	1/2-13 X 5/8	100	
JTA08024	1/2-13 X 3/4	100	
JTA08032X	1/2-13 X 1	100	
JTA08048X	1/2-13 X 1 1/2	25	
JTA508016X	1/2-20 X 1/2	100	
JTA10040X	5/8-11 X 1 1/4	25	

**SOCKET SET SCREW - 1/2 DOG POINT**

PLAIN FINISH

Line: 269-00

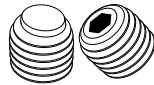

PART NUMBER	SIZE	QTY/BX	LIST PRICE
JUA66008	6/32 X 1/4	100	
JUA66012	6/32 X 3/8	100	
JUA88006	8/32 X 3/16	100	
JUA88008	8/32 X 1/4	100	
JUA88010	8/32 X 5/16	100	
JUA88012	8/32 X 3/8	100	
JUA88016	8/32 X 1/2	100	
JUA03006	10/24 X 3/16	100	
JUA03008	10/24 X 1/4	100	
JUA03010	10/24 X 5/16	100	
JUA03012	10/24 X 3/8	100	
JUA03016	10/24 X 1/2	100	
JUA03020	10/24 X 5/8	100	
JUA03024	10/24 X 3/4	100	
JUA03032	10/24 X 1	100	
JUAS03006	10/32 X 3/16	100	
JUAS03008	10/32 X 1/4	100	
JUAS03012	10/32 X 3/8	100	
JUAS03016	10/32 X 1/2	100	
JUAS03024	10/32 X 3/4	100	
JUA04008	1/4-20 X 1/4	100	
JUA04010	1/4-20 X 5/16	100	
JUA04012	1/4-20 X 3/8	100	
JUA04016	1/4-20 X 1/2	100	
JUA04020	1/4-20 X 5/8	100	
JUA04024	1/4-20 X 3/4	100	
JUA04032	1/4-20 X 1	100	
JUAS04008	1/4-28 X 1/4	100	
JUAS04012	1/4-28 X 3/8	100	
JUA05008X	5/16-18 X 1/4	100	
JUA05010	5/16-18 X 5/16	100	
JUA05012	5/16-18 X 3/8	100	
JUA05016	5/16-18 X 1/2	100	
JUA05020	5/16-18 X 5/8	100	
JUA05024	5/16-18 X 3/4	100	
JUA05032	5/16-18 X 1	100	
JUAS05012	5/16-24 X 3/8	100	
JUA06012	3/8-16 X 3/8	100	
JUA06016	3/8-16 X 1/2	100	
JUA06020	3/8-16 X 5/8	100	
JUA06024	3/8-16 X 3/4	100	
JUA06032	3/8-16 X 1	100	
JUA06040	3/8-16 X 1 1/4	100	
JUAS06012X	3/8-24 X 3/8	100	
JUAS06016	3/8-24 X 1/2	100	
JUA07048	7/16-14 X 1 1/2	50	

(continued...)

**SOCKET SET SCREW - 1/2 DOG POINT (cont.)**

PLAIN FINISH

Line: 269-00

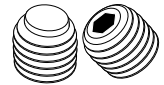

PART NUMBER	SIZE	QTY/BX	LIST PRICE
JUA08016	1/2-13 X 1/2	100	
JUA08020	1/2-13 X 5/8	100	
JUA08024	1/2-13 X 3/4	100	
JUA08032X	1/2-13 X 1	100	
JUA08040	1/2-13 X 1 1/4	50	
JUA10032	5/8-11 X 1	50	
JUA10040	5/8-11 X 1 1/4	25	
JUAS10020	5/8-18 X 5/8	50	
JUA12080	3/4-10 X 2 1/2	25	

**SOCKET SET SCREW - FULL DOG POINT**

PLAIN FINISH

Line: 269-01

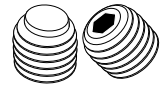

PART NUMBER	SIZE	QTY/BX	LIST PRICE
JGE08016X	1/2-13 X 1/2	50	

NOTE: OTHER SIZES AVAILABLE - CALL FOR PRICE & DELIVERY

**SOCKET SET SCREW - OVAL POINT**

PLAIN FINISH

Line: 270-00

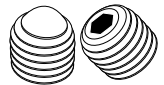

PART NUMBER	SIZE	QTY/BX	LIST PRICE
JVA44004	4/40 X 1/8	100	
JVA44006	4/40 X 3/16	100	
JVA55006X	5/40 X 3/16	100	
JVA55008	5/44 X 1/4	100	
JVA66004X	6/32 X 1/8	100	
JVA66006X	6/32 X 3/16	100	
JVA66008	6/32 X 1/4	100	
JVA66010	6/32 X 5/16	100	
JVA66012	6/32 X 3/8	100	
JVA88006	8/32 X 3/16	100	
JVA88008	8/32 X 1/4	100	
JVA88016	8/32 X 1/2	100	
JVA03006	10/24 X 3/16	100	
JVA03008	10/24 X 1/4	100	
JVA03012	10/24 X 3/8	100	
JVA03016	10/24 X 1/2	100	
JVAS03006	10/32 X 3/16	100	
JVAS03008	10/32 X 1/4	100	
JVAS03032X	10/32 X 1	100	
JVA04008	1/4-20 X 1/4	100	
JVA04010	1/4-20 X 5/16	100	
JVA04012	1/4-20 X 3/8	100	
JVA04016	1/4-20 X 1/2	100	

(continued...)



## SOCKET SET SCREW - OVAL POINT (cont.)

PLAIN FINISH

Line: 270-00

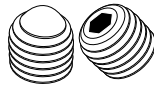

PART NUMBER	SIZE	QTY/BX	LIST PRICE
JVA04020	1/4-20 X 5/8	100	
JVA04024	1/4-20 X 3/4	100	
JVA04032	1/4-20 X 1	100	
JVAS04008	1/4-28 X 1/4	100	
JVAS04024	1/4-28 X 3/4	100	
JVA05008	5/16-18 X 1/4	100	
JVA05010	5/16-18 X 5/16	100	
JVA05012	5/16-18 X 3/8	100	
JVA05016	5/16-18 X 1/2	100	
JVA05020	5/16-18 X 5/8	100	
JVA05024	5/16-18 X 3/4	100	
JVA05032	5/16-18 X 1	100	
JVA06012	3/8-16 X 3/8	100	
JVA06016	3/8-16 X 1/2	100	
JVA06020	3/8-16 X 5/8	100	
JVA06024	3/8-16 X 3/4	100	
JVA06032	3/8-16 X 1	100	
JVAS06016	3/8-24 X 1/2	100	
JVA07028	7/16-14 X 7/8	100	
JVA08016	1/2-13 X 1/2	100	
JVA08024	1/2-13 X 3/4	100	
JVA08032	1/2-13 X 1	100	

## SOCKET SET SCREW - KNURLED POINT

PLAIN FINISH

Line: 271-00

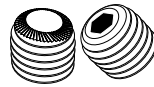

PART NUMBER	SIZE	QTY/BX	LIST PRICE
JWA44004	4/40 X 1/8	100	
JWA44006	4/40 X 3/16	100	
JWA44008	4/40 X 1/4	100	
JWA44010	4/40 X 5/16	100	
JWA44012	4/40 X 3/8	100	
JWA44016	4/40 X 1/2	100	
JWA44020	4/40 X 5/8	100	
JWAS44004	4/48 X 1/8	100	
JWAS44006	4/48 X 3/16	100	
JWAS44008	4/48 X 1/4	100	
JWAS44012	4/48 X 3/8	100	
JWAS5004	5/40 X 1/8	100	
JWAS5006	5/40 X 3/16	100	
JWAS5008X	5/40 X 1/4	100	
JWAS5010	5/40 X 5/16	100	
JWAS5012	5/40 X 3/8	100	
JWAS5016	5/40 X 1/2	100	
JWAS5020	5/40 X 5/8	100	
JWAS5024	5/40 X 3/4	100	

(continued...)

## SOCKET SET SCREW - KNURLED POINT (cont.)

PLAIN FINISH

Line: 271-00

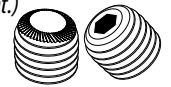

PART NUMBER	SIZE	QTY/BX	LIST PRICE
JWA66004	6/32 X 1/8	100	
JWA66006	6/32 X 3/16	100	
JWA66008	6/32 X 1/4	100	
JWA66010	6/32 X 5/16	100	
JWA66012	6/32 X 3/8	100	
JWA66014	6/32 X 7/16	100	
JWA66016	6/32 X 1/2	100	
JWA66020	6/32 X 5/8	100	
JWA66024	6/32 X 3/4	100	
JWA66032	6/32 X 1	100	
JWAS66004	6/40 X 1/8	100	
JWAS66006	6/40 X 3/16	100	
JWAS66012	6/40 X 3/8	100	
JWA88004	8/32 X 1/8	100	
JWA88006	8/32 X 3/16	100	
JWA88008	8/32 X 1/4	100	
JWA88010	8/32 X 5/16	100	
JWA88012	8/32 X 3/8	100	
JWA88014	8/32 X 7/16	100	
JWA88016	8/32 X 1/2	100	
JWA88020	8/32 X 5/8	100	
JWA88024	8/32 X 3/4	100	
JWA88032	8/32 X 1	100	
JWAS88008	8/36 X 1/4	100	
JWAS88012	8/36 X 3/8	100	
JWAS88016	8/36 X 1/2	100	
JWA03006	10/24 X 3/16	100	
JWA03008	10/24 X 1/4	100	
JWA03010	10/24 X 5/16	100	
JWA03012	10/24 X 3/8	100	
JWA03014	10/24 X 7/16	100	
JWA03016	10/24 X 1/2	100	
JWA03020	10/24 X 5/8	100	
JWA03024	10/24 X 3/4	100	
JWA03028	10/24 X 7/8	100	
JWA03032	10/24 X 1	100	
JWA03040	10/24 X 1 1/4	100	
JWAS03006	10/32 X 3/16	100	
JWAS03008	10/32 X 1/4	100	
JWAS03010	10/32 X 5/16	100	
JWAS03012	10/32 X 3/8	100	
JWAS03014	10/32 X 7/16	100	
JWAS03016	10/32 X 1/2	100	
JWAS03020	10/32 X 5/8	100	
JWAS03024	10/32 X 3/4	100	
JWAS03032	10/32 X 1	100	

(continued...)

**SOCKET SET SCREW - KNURLED POINT (cont.)**

PLAIN FINISH

Line: 271-00

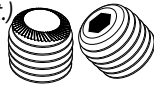

PART NUMBER	SIZE	QTY/BX	LIST PRICE
JWA03040	10/32 X 1 1/4	100	
JWA04006	1/4-20 X 3/16	100	
JWA04008	1/4-20 X 1/4	100	
JWA04010	1/4-20 X 5/16	100	
JWA04012	1/4-20 X 3/8	100	
JWA04014	1/4-20 X 7/16	100	
JWA04016	1/4-20 X 1/2	100	
JWA04020	1/4-20 X 5/8	100	
JWA04024	1/4-20 X 3/4	100	
JWA04028	1/4-20 X 7/8	100	
JWA04032	1/4-20 X 1	100	
JWA04040	1/4-20 X 1 1/4	100	
JWA04048	1/4-20 X 1 1/2	100	
JWA04056	1/4-20 X 1 3/4	100	
JWA04064	1/4-20 X 2	100	
JWAS04006	1/4-28 X 3/16	100	
JWAS04008	1/4-28 X 1/4	100	
JWAS04010	1/4-28 X 5/16	100	
JWAS04012	1/4-28 X 3/8	100	
JWAS04014	1/4-28 X 7/16	100	
JWAS04016	1/4-28 X 1/2	100	
JWAS04020	1/4-28 X 5/8	100	
JWAS04024	1/4-28 X 3/4	100	
JWAS04032	1/4-28 X 1	100	
JWAS04040	1/4-28 X 1 1/4	100	
JWA05008	5/16-18 X 1/4	100	
JWA05010	5/16-18 X 5/16	100	
JWA05012	5/16-18 X 3/8	100	
JWA05014	5/16-18 X 7/16	100	
JWA05016	5/16-18 X 1/2	100	
JWA05020X	5/16-18 X 5/8	100	
JWA05024	5/16-18 X 3/4	100	
JWA05028	5/16-18 X 7/8	100	
JWA05032X	5/16-18 X 1	100	
JWA05040	5/16-18 X 1 1/4	100	
JWA05048X	5/16-18 X 1 1/2	100	
JWA05064X	5/16-18 X 2	100	
JWAS05008	5/16-24 X 1/4	100	
JWAS05010	5/16-24 X 5/16	100	
JWAS05012	5/16-24 X 3/8	100	
JWAS05014	5/16-24 X 7/16	100	
JWAS05016	5/16-24 X 1/2	100	
JWAS05020	5/16-24 X 5/8	100	
JWAS05024	5/16-24 X 3/4	100	
JWAS05032	5/16-24 X 1	100	
JWAS05064X	5/16-24 X 2	100	

(continued...)

**SOCKET SET SCREW - KNURLED POINT (cont.)**

PLAIN FINISH

Line: 271-00

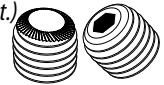

PART NUMBER	SIZE	QTY/BX	LIST PRICE
JWA06008	3/8-16 X 1/4	100	
JWA06010	3/8-16 X 5/16	100	
JWA06012	3/8-16 X 3/8	100	
JWA06014	3/8-16 X 7/16	100	
JWA06016	3/8-16 X 1/2	100	
JWA06020	3/8-16 X 5/8	100	
JWA06024	3/8-16 X 3/4	100	
JWA06028	3/8-16 X 7/8	100	
JWA06032X	3/8-16 X 1	100	
JWA06040X	3/8-16 X 1 1/4	100	
JWA06048	3/8-16 X 1 1/2	100	
JWA06056	3/8-16 X 1 3/4	100	
JWA06064	3/8-16 X 2	100	
JWA06080	3/8-16 X 2 1/2	100	
JWAS06008	3/8-24 X 1/4	100	
JWAS06010	3/8-24 X 5/16	100	
JWAS06012	3/8-24 X 3/8	100	
JWAS06016X	3/8-24 X 1/2	100	
JWAS06020	3/8-24 X 5/8	100	
JWAS06024	3/8-24 X 3/4	100	
JWAS06032	3/8-24 X 1	100	
JWAS06040	3/8-24 X 1 1/4	100	
JWAS06048	3/8-24 X 1 1/2	100	
JWA07012	7/16-14 X 3/8	100	
JWA07014	7/16-14 X 7/16	100	
JWA07016	7/16-14 X 1/2	100	
JWA07020	7/16-14 X 5/8	100	
JWA07024	7/16-14 X 3/4	100	
JWA07032	7/16-14 X 1	100	
JWA07040	7/16-14 X 1 1/4	100	
JWA07048	7/16-14 X 1 1/2	100	
JWA07064	7/16-14 X 2	50	
JWAS07016	7/16-20 X 1/2	100	
JWA08012	1/2-13 X 3/8	100	
JWA08014	1/2-13 X 7/16	100	
JWA08016	1/2-13 X 1/2	100	
JWA08020	1/2-13 X 5/8	100	
JWA08024X	1/2-13 X 3/4	100	
JWA08028	1/2-13 X 7/8	100	
JWA08032X	1/2-13 X 1	100	
JWA08040	1/2-13 X 1 1/4	100	
JWA08048	1/2-13 X 1 1/2	100	
JWA08056	1/2-13 X 1 3/4	50	
JWA08064	1/2-13 X 2	50	
JWA08080	1/2-13 X 2 1/2	50	
JWA08096	1/2-13 X 3	50	

(continued...)

## SOCKET SET SCREW - KNURLED POINT (cont.)

PLAIN FINISH

Line: 271-00

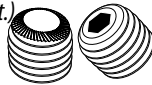

PART NUMBER	SIZE	QTY/BX	LIST PRICE
JWAS08016	1/2-20 X 1/2	100	
JWAS08020	1/2-20 X 5/8	100	
JWAS08024	1/2-20 X 3/4	100	
JWAS08032X	1/2-20 X 1	100	
JWA10016	5/8-11 X 1/2	50	
JWA10020	5/8-11 X 5/8	50	
JWA10024	5/8-11 X 3/4	50	
JWA10028	5/8-11 X 7/8	50	
JWA10032	5/8-11 X 1	50	
JWA10040	5/8-11 X 1 1/4	25	
JWA10048	5/8-11 X 1 1/2	25	
JWA10056	5/8-11 X 1 3/4	25	
JWA10064X	5/8-11 X 2	25	
JWA10080	5/8-11 X 2 1/2	25	
JWA10096	5/8-11 X 3	25	
JWAS10020	5/8-18 X 5/8	50	
JWAS10032	5/8-18 X 1	50	
JWA12020	3/4-10 X 5/8	50	
JWA12024	3/4-10 X 3/4	50	
JWA12032X	3/4-10 X 1	25	
JWA12040X	3/4-10 X 1 1/4	25	
JWA12048X	3/4-10 X 1 1/2	25	
JWA12056	3/4-10 X 1 3/4	10	
JWA12064	3/4-10 X 2	10	
JWA12080	3/4-10 X 2 1/2	10	
JWA12096	3/4-10 X 3	10	
JWA14028	7/8-9 X 7/8	10	
JWA14032	7/8-9 X 1	10	
JWA14048X	7/8-9 X 1 1/2	10	
JWA14064	7/8-9 X 2	10	
JWA14080	7/8-9 X 2 1/2	10	
JWA14096	7/8-9 X 3	10	
JWA16032	1-8 X 1	10	
JWA16048X	1-8 X 1 1/2	10	
JWA16064	1-8 X 2	10	
JWA16080	1-8 X 2 1/2	10	
JWA16096	1-8 X 3	10	

## SOCKET SET JAM HOLLOW LOCK SCREW

PLAIN FINISH

Line: 272-00

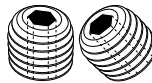

PART NUMBER	SIZE	QTY/BX	LIST PRICE
JXA44025	4/40 X 5/64	100	
JXA55003	5/40 X 3/32	100	
JXA66003	6/32 X 3/32	100	
JXA88035	8/32 X 7/64	100	

(continued...)

## SOCKET SET JAM HOLLOW LOCK (cont.)

PLAIN FINISH

Line: 272-00

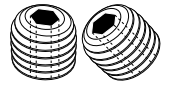

PART NUMBER	SIZE	QTY/BX	LIST PRICE
JXA03004	10/24 X 1/8	100	
JXAS03004	10/32 X 1/8	100	
JXA04004	1/4-20 X 1/8	100	
JXAS04004	1/4-28 X 1/8	100	
JXA05005	5/16-18 X 5/32	100	
JXAS05005	5/16-24 X 5/32	100	
JXA06006	3/8-16 X 3/16	100	
JXAS06006	3/8-24 X 3/16	100	
JXA07007	7/16-14 X 7/32	100	
JXAS07007	7/16-20 X 7/32	100	
JXA08008	1/2-13 X 1/4	100	
JXAS08008	1/2-20 X 1/4	100	
JXA10010	5/8-11 X 5/16	100	
JXAS10010	5/8-18 X 5/16	100	
JXA12012	3/4-10 X 3/8	50	
JXAS12012	3/4-16 X 3/8	50	
JXA14014	7/8-9 X 7/16	25	
JXAS14014	7/8-14 X 7/16	25	
JXA16016	1-8 X 1/2	25	
JXAS16016	1-14 X 1/2	25	

## SLOTTED SET SCREW - CUP POINT

PLAIN FINISH

Line: 272-01

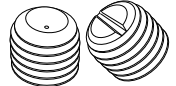

PART NUMBER	SIZE	QTY/BX	LIST PRICE
JFE66006	6/32 X 3/16	100	
JFE66008X	6/32 X 1/4	100	
JFE88008X	8/32 X 1/4	100	
JFE88016X	8/32 X 1/2	100	
JFE03010X	10/24 X 5/16	100	
JFE03012X	10/24 X 3/8	100	
JFES03008X	10/32 X 1/4	100	
JFES03012X	10/32 X 3/8	100	
JFE04024X	1/4 X 3/4	100	
JFE04008	1/4-20 X 1/4	100	
JFE04020X	1/4-20 X 5/8	100	
JFE05008X	5/16-18 X 1/4	100	
JFE05012X	5/16-18 X 3/8	5375	
JFE05016X	5/16-18 X 1/2	100	
JFE06020	3/8-16 X 5/8	100	
JFE08040X	1/2-13 X 1 1/4	100	
JFE10024X	5/8-11 X 3/4	100	
JFE16064X	1-8 X 2	100	
JFE20072X	1 1/4-7 X 2 1/4	100	
JFE24096X	1 1/2-6 X 3	100	

# SQUARE HD SET SCREW - CUP POINT

PLAIN FINISH - HARDENED

Line: 273-00

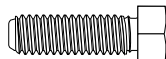

PART NUMBER	SIZE	QTY/BX	LIST PRICE
KBA04012	1/4-20 X 3/8	100	
KBA04016	1/4-20 X 1/2	100	
KBA04020	1/4-20 X 5/8	100	
KBA04024	1/4-20 X 3/4	100	
KBA04028	1/4-20 X 7/8	100	
KBA04032	1/4-20 X 1	100	
KBA04040	1/4-20 X 1 1/4	100	
KBA04048	1/4-20 X 1 1/2	100	
KBA04056	1/4-20 X 1 3/4	100	
KBA04064	1/4-20 X 2	100	
KBA04072	1/4-20 X 2 1/4	50	
KBA04080	1/4-20 X 2 1/2	50	
KBA04096	1/4-20 X 3	50	
KBA05012X	5/16-18 X 3/8	100	
KBA05016	5/16-18 X 1/2	100	
KBA05020	5/16-18 X 5/8	100	
KBA05024	5/16-18 X 3/4	100	
KBA05028	5/16-18 X 7/8	100	
KBA05032	5/16-18 X 1	100	
KBA05040	5/16-18 X 1 1/4	100	
KBA05048	5/16-18 X 1 1/2	100	
KBA05056	5/16-18 X 1 3/4	100	
KBA05064	5/16-18 X 2	100	
KBA05072	5/16-18 X 2 1/4	50	
KBA05080	5/16-18 X 2 1/2	50	
KBA05088	5/16-18 X 2 3/4	50	
KBA05096	5/16-18 X 3	50	
KBA05112	5/16-18 X 3 1/2	50	
KBA06016	3/8-16 X 1/2	100	
KBA06020	3/8-16 X 5/8	100	
KBA06024	3/8-16 X 3/4	100	
KBA06028	3/8-16 X 7/8	100	
KBA06032	3/8-16 X 1	100	
KBA06040	3/8-16 X 1 1/4	100	
KBA06048	3/8-16 X 1 1/2	100	
KBA06056	3/8-16 X 1 3/4	50	
KBA06064	3/8-16 X 2	50	
KBA06072	3/8-16 X 2 1/4	50	
KBA06080	3/8-16 X 2 1/2	50	
KBA06096	3/8-16 X 3	50	
KBA06112	3/8-16 X 3 1/2	25	
KBA06128	3/8-16 X 4	25	
KBA06160	3/8-16 X 5	25	
KBA07016	7/16-14 X 1/2	50	
KBA07020X	7/16-14 X 5/8	50	
KBA07024	7/16-14 X 3/4	50	

(continued...)

# SQUARE HD SET SCREW - CUP POINT (cont.)

PLAIN FINISH - HARDENED

Line: 273-00



PART NUMBER	SIZE	QTY/BX	LIST PRICE
KBA07028X	7/16-14 X 7/8	50	
KBA07032	7/16-14 X 1	50	
KBA07040	7/16-14 X 1 1/4	50	
KBA07048	7/16-14 X 1 1/2	50	
KBA07056	7/16-14 X 1 3/4	50	
KBA07064	7/16-14 X 2	50	
KBA07080	7/16-14 X 2 1/2	25	
KBA07096	7/16-14 X 3	25	
KBA07112X	7/16-14 X 3 1/2	25	
KBA08020	1/2-13 X 5/8	50	
KBA08024	1/2-13 X 3/4	50	
KBA08028X	1/2-13 X 7/8	50	
KBA08032	1/2-13 X 1	50	
KBA08040	1/2-13 X 1 1/4	50	
KBA08048	1/2-13 X 1 1/2	50	
KBA08056	1/2-13 X 1 3/4	50	
KBA08064	1/2-13 X 2	50	
KBA08072	1/2-13 X 2 1/4	25	
KBA08080	1/2-13 X 2 1/2	25	
KBA08088	1/2-13 X 2 3/4	25	
KBA08096	1/2-13 X 3	25	
KBA08112	1/2-13 X 3 1/2	25	
KBA08128	1/2-13 X 4	25	
KBA08144	1/2-13 X 4 1/2	25	
KBA08160	1/2-13 X 5	25	
KBA08192	1/2-13 X 6	25	
KBA09048X	9/16-12 X 1 1/2	25	
KBA09064X	9/16-12 X 2	25	
KBA10024X	5/8-11 X 3/4	25	
KBA10032	5/8-11 X 1	25	
KBA10040	5/8-11 X 1 1/4	25	
KBA10048	5/8-11 X 1 1/2	25	
KBA10056	5/8-11 X 1 3/4	25	
KBA10064	5/8-11 X 2	25	
KBA10072	5/8-11 X 2 1/4	25	
KBA10080	5/8-11 X 2 1/2	25	
KBA10088	5/8-11 X 2 3/4	25	
KBA10096	5/8-11 X 3	25	
KBA10112	5/8-11 X 3 1/2	25	
KBA10128	5/8-11 X 4	25	
KBA10144	5/8-11 X 4 1/2	10	
KBA10160	5/8-11 X 5	10	
KBA10176X	5/8-11 X 5 1/2	10	
KBA10192	5/8-11 X 6	10	
KBA10224	5/8-11 X 7	10	
KBA10256	5/8-11 X 8	10	

(continued...)

**SQUARE HD SET SCREW - CUP POINT (cont.)**

PLAIN FINISH - HARDENED

Line: 273-00



PART NUMBER	SIZE	QTY/BX	LIST PRICE
KBA12032	3/4-10 X 1	25	
KBA12040	3/4-10 X 1 1/4	25	
KBA12048	3/4-10 X 1 1/2	25	
KBA12056	3/4-10 X 1 3/4	25	
KBA12064	3/4-10 X 2	25	
KBA12072	3/4-10 X 2 1/4	25	
KBA12080	3/4-10 X 2 1/2	25	
KBA12088	3/4-10 X 2 3/4	25	
KBA12096	3/4-10 X 3	25	
KBA12112	3/4-10 X 3 1/2	25	
KBA12128	3/4-10 X 4	25	
KBA12144	3/4-10 X 4 1/2	10	
KBA12160	3/4-10 X 5	10	
KBA12192	3/4-10 X 6	10	
KBA12224	3/4-10 X 7	10	
KBA14048X	7/8-9 X 1 1/2	25	
KBA14064	7/8-9 X 2	25	
KBA14080	7/8-9 X 2 1/2	25	
KBA14096	7/8-9 X 3	25	
KBA14112	7/8-9 X 3 1/2	25	
KBA14128	7/8-9 X 4	25	
KBA14144	7/8-9 X 4 1/2	10	
KBA14160	7/8-9 X 5	10	
KBA14192	7/8-9 X 6	10	
KBA14224	7/8-9 X 7	10	
KBA14256	7/8-9 X 8	10	
KBA16064	1-8 X 2	25	
KBA16080	1-8 X 2 1/2	25	
KBA16096	1-8 X 3	25	
KBA16112	1-8 X 3 1/2	10	
KBA16128	1-8 X 4	10	
KBA16144	1-8 X 4 1/2	10	
KBA16160	1-8 X 5	10	
KBA16192	1-8 X 6	10	
KBA16256	1-8 X 8	10	
KBA18128	1 1/8-7 X 4	1	
KBA18160	1 1/8-7 X 5	1	
KBA18192	1 1/8-7 X 6	1	
KBA18256	1 1/8-7 X 8	1	
KBA20064	1 1/4-7 X 2	5	
KBA20144	1 1/4-7 X 4 1/2	1	
KBA20192	1 1/4-7 X 6	1	
KBA20224	1 1/4-7 X 7	1	
KBA20256	1 1/4-7 X 8	1	
KBA20320	1 1/4-7 X 10	1	
KBA24160	1 1/2-6 X 5	1	

(continued...)

**SQUARE HD SET SCREW - CUP POINT (cont.)**

PLAIN FINISH - HARDENED

Line: 273-00



PART NUMBER	SIZE	QTY/BX	LIST PRICE
KBA24192	1 1/2-6 X 6	1	
KBA24256	1 1/2-6 X 8	1	
KBA24320	1 1/2-6 X 10	1	

**COUNTER BORE CAP SCREW 12 POINT DRIVE**

ALLOY STEEL

Line: 274-00

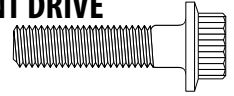

PART NUMBER	SIZE	QTY/BX	LIST PRICE
KCA04016	1/4-20 X 1/2	100	
KCA04024	1/4-20 X 3/4	100	
KCA04032	1/4-20 X 1	100	
KCA04040	1/4-20 X 1 1/4	100	
KCA04064	1/4-20 X 2	100	
KCAS04024	1/4-28 X 3/4	100	
KCA05016	5/16-18 X 1/2	100	
KCA05020	5/16-18 X 5/8	100	
KCA05024	5/16-18 X 3/4	100	
KCA05032	5/16-18 X 1	100	
KCA05040	5/16-18 X 1 1/4	100	
KCA05048	5/16-18 X 1 1/2	100	
KCA05056	5/16-18 X 1 3/4	100	
KCA05080	5/16-18 X 2 1/2	50	
KCA05104X	5/16-18 X 3 1/4	50	
KCAS05028X	5/16-24 X 7/8	100	
KCAS05032X	5/16-24 X 1	100	
KCAS05064	5/16-24 X 2	100	
KCAS05080X	5/16-24 X 2 1/2	50	
KCA06024	3/8-16 X 3/4	100	
KCA06032	3/8-16 X 1	100	
KCA06040	3/8-16 X 1 1/4	100	
KCA06048	3/8-16 X 1 1/2	100	
KCA06056	3/8-16 X 1 3/4	50	
KCA06064	3/8-16 X 2	50	
KCA06072	3/8-16 X 2 1/4	50	
KCA06080	3/8-16 X 2 1/2	50	
KCA06088X	3/8-16 X 2 3/4	50	
KCA06096	3/8-16 X 3	50	
KCA06104X	3/8-16 X 3 1/4	50	
KCAS06024	3/8-24 X 3/4	100	
KCAS06032X	3/8-24 X 1	100	
KCAS06040	3/8-24 X 1 1/4	100	
KCAS06064	3/8-24 X 2	50	
KCA07032	7/16-14 X 1	50	
KCA07040	7/16-14 X 1 1/4	50	
KCA07048	7/16-14 X 1 1/2	50	
KCA07056	7/16-14 X 1 3/4	50	
KCA07064	7/16-14 X 2	50	

(continued...)

## COUNTER BORE CAP SCREW

ALLOY STEEL (cont.)

Line: 274-00

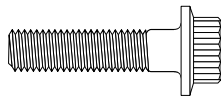

PART NUMBER	SIZE	QTY/BX	LIST PRICE
KCA07080	7/16-14 X 2 1/2	50	
KCA07128	7/16-14 X 4	25	
KCA507024	7/16-20 X 3/4	100	
KCA507032	7/16-20 X 1	100	
KCA507040	7/16-20 X 1 1/4	50	
KCA507064	7/16-20 X 2	50	
KCA08040X	1/2-13 X 1 1/4	50	
KCA08048	1/2-13 X 1 1/2	50	
KCA08064	1/2-13 X 2	50	
KCA08072	1/2-13 X 2 1/4	25	
KCA08080	1/2-13 X 2 1/2	25	
KCA08096	1/2-13 X 3	25	
KCA08112	1/2-13 X 3 1/2	25	
KCA08128	1/2-13 X 4	25	
KCA08192	1/2-13 X 6	25	
KCA08224X	1/2-13 X 7	25	
KCA508032	1/2-20 X 1	50	
KCA508040	1/2-20 X 1 1/4	50	
KCA508048	1/2-20 X 1 1/2	50	
KCA508064X	1/2-20 X 2	50	
KCA508072	1/2-20 X 2 1/4	25	
KCA10040	5/8-11 X 1 1/4	25	
KCA10048	5/8-11 X 1 1/2	25	
KCA10056	5/8-11 X 1 3/4	25	
KCA10064	5/8-11 X 2	25	
KCA10072	5/8-11 X 2 1/4	25	
KCA10080	5/8-11 X 2 1/2	25	
KCA10096	5/8-11 X 3	25	
KCA10112	5/8-11 X 3 1/2	25	
KCA10128	5/8-11 X 4	25	
KCA510048	5/8-18 X 1 1/2	25	
KCA510056	5/8-18 X 1 3/4	25	
KCA510064	5/8-18 X 2	25	
KCA510072	5/8-18 X 2 1/4	25	
KCA510080	5/8-18 X 2 1/2	25	
KCA510088	5/8-18 X 2 3/4	25	
KCA510128	5/8-18 X 4	25	
KCA12048	3/4-10 X 1 1/2	25	
KCA12056	3/4-10 X 1 3/4	25	
KCA12064	3/4-10 X 2	25	
KCA12072	3/4-10 X 2 1/4	25	
KCA12080	3/4-10 X 2 1/2	25	
KCA12088	3/4-10 X 2 3/4	25	
KCA12112	3/4-10 X 3 1/2	25	
KCA512048	3/4-16 X 1 1/2	25	
KCA512056	3/4-16 X 1 3/4	25	

(continued...)

## COUNTER BORE CAP SCREW

ALLOY STEEL (cont.)

Line: 274-00

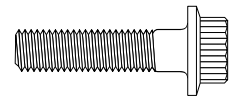

PART NUMBER	SIZE	QTY/BX	LIST PRICE
KCA512064	3/4-16 X 2	25	
KCA512080	3/4-16 X 2 1/2	25	
KCA512112	3/4-16 X 3 1/2	25	
KCA14128	7/8-9 X 4	10	
KCA16064	1-8 X 2	10	
KCA16096	1-8 X 3	10	

## SOCKET SHOULDER SCREW - DOMESTIC

ALLOY STEEL

Line: 276-00

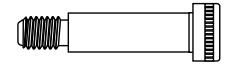

PART NUMBER	SIZE	QTY/BX	LIST PRICE
KJA04012	1/4 X 3/8	25	
KJA04016	1/4 X 1/2	25	
KJA04020	1/4 X 5/8	25	
KJA04024	1/4 X 3/4	25	
KJA04032	1/4 X 1	25	
KJA04040	1/4 X 1 1/4	25	
KJA04048	1/4 X 1 1/2	25	
KJA04064	1/4 X 2	25	
KJA05012	5/16 X 3/8	25	
KJA05016	5/16 X 1/2	25	
KJA05020	5/16 X 5/8	25	
KJA05024	5/16 X 3/4	25	
KJA05032	5/16 X 1	25	
KJA05040	5/16 X 1 1/4	25	
KJA05048	5/16 X 1 1/2	25	
KJA05056	5/16 X 1 3/4	25	
KJA05064	5/16 X 2	25	
KJA05080	5/16 X 2 1/2	25	
KJA06012	3/8 X 3/8	25	
KJA06016	3/8 X 1/2	25	
KJA06020	3/8 X 5/8	25	
KJA06024	3/8 X 3/4	25	
KJA06032	3/8 X 1	25	
KJA06040	3/8 X 1 1/4	25	
KJA06048	3/8 X 1 1/2	25	
KJA06056	3/8 X 1 3/4	25	
KJA06064	3/8 X 2	25	
KJA06072	3/8 X 2 1/4	25	
KJA06080	3/8 X 2 1/2	25	
KJA06088	3/8 X 2 3/4	25	
KJA06096	3/8 X 3	25	
KJA06104	3/8 X 3 1/4	25	
KJA06112	3/8 X 3 1/2	25	
KJA06120X	3/8 X 3 3/4	25	
KJA06128	3/8 X 4	25	

(continued...)

## SOCKET SHOULDER SCREW (cont.)

ALLOY STEEL

Line: 276-00

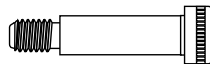

PART NUMBER	SIZE	QTY/BX	LIST PRICE
KJA08016	1/2 X 1/2	25	
KJA08020	1/2 X 5/8	25	
KJA08024	1/2 X 3/4	25	
KJA08032	1/2 X 1	25	
KJA08040	1/2 X 1 1/4	25	
KJA08048	1/2 X 1 1/2	25	
KJA08056	1/2 X 1 3/4	25	
KJA08064	1/2 X 2	25	
KJA08072	1/2 X 2 1/4	25	
KJA08080	1/2 X 2 1/2	25	
KJA08088	1/2 X 2 3/4	25	
KJA08096	1/2 X 3	25	
KJA08104	1/2 X 3 1/4	25	
KJA08112	1/2 X 3 1/2	25	
KJA08120X	1/2 X 3 3/4	25	
KJA08128	1/2 X 4	25	
KJA08136	1/2 X 4 1/4	25	
KJA08144	1/2 X 4 1/2	10	
KJA08152X	1/2 X 4 3/4	10	
KJA08160	1/2 X 5	10	
KJA10032X	5/8 X 1	25	
KJA10040	5/8 X 1 1/4	25	
KJA10048	5/8 X 1 1/2	25	
KJA10056	5/8 X 1 3/4	25	
KJA10064	5/8 X 2	25	
KJA10072	5/8 X 2 1/4	25	
KJA10080	5/8 X 2 1/2	25	
KJA10088	5/8 X 2 3/4	25	
KJA10096	5/8 X 3	25	
KJA10104	5/8 X 3 1/4	25	
KJA10112	5/8 X 3 1/2	25	
KJA10120X	5/8 X 3 3/4	25	
KJA10128	5/8 X 4	10	
KJA10136	5/8 X 4 1/4	10	
KJA10144	5/8 X 4 1/2	10	
KJA10152X	5/8 X 4 3/4	10	
KJA10160	5/8 X 5	10	
KJA10176	5/8 X 5 1/2	10	
KJA10192	5/8 X 6	10	
KJA12040	3/4 X 1 1/4	10	
KJA12056	3/4 X 1 3/4	10	
KJA12064	3/4 X 2	10	
KJA12072	3/4 X 2 1/4	10	
KJA12080	3/4 X 2 1/2	10	
KJA12088	3/4 X 2 3/4	10	
KJA12096	3/4 X 3	10	

(continued...)

## SOCKET SHOULDER SCREW (cont.)

ALLOY STEEL

Line: 276-00

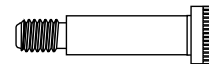

PART NUMBER	SIZE	QTY/BX	LIST PRICE
KJA12104	3/4 X 3 1/4	10	
KJA12112	3/4 X 3 1/2	10	
KJA12120	3/4 X 3 3/4	10	
KJA12128	3/4 X 4	10	
KJA12136X	3/4 X 4 1/4	10	
KJA12144	3/4 X 4 1/2	10	
KJA12152	3/4 X 4 3/4	10	
KJA12160	3/4 X 5	10	
KJA12176	3/4 X 5 1/2	10	
KJA12192	3/4 X 6	10	

## SHORT ARM HEX KEY

PLAIN FINISH - MADE IN THE U.S.A.

Line: 277-00



PART NUMBER	SIZE	QTY/BX	LIST PRICE
DKC028	.028	25	
DKC035	.035	25	
DKC050	.050	25	
DKC062	1/16	25	
DKC078	5/64	25	
DKC093	3/32	25	
DKC109	7/64	25	
DKC125	1/8	25	
DKC140	9/64	25	
DKC156	5/32	25	
DKC187	3/16	25	
DKC218	7/32	10	
DKC250	1/4	10	
DKC312	5/16	5	
DKC375	3/8	5	
DKC437	7/16	1	
DKC500	1/2	1	
DKC562	9/16	1	
DKC625	5/8	1	
DKC750	3/4	1	
DKC875	7/8	1	
DKC100	1	1	
DKC1250	1 1/4	1	
DKC1500	1 1/2	1	

## LONG ARM HEX KEY

PLAIN FINISH - MADE IN THE U.S.A.

Line: 278-00

PART NUMBER	SIZE	QTY/BX	LIST PRICE
DLC035	.035	25	
DLC050X	.050	25	
DLC062	1/16	25	
DLC078	5/64	25	
DLC093	3/32	25	
DLC109	7/64	25	
DLC125	1/8	25	
DLC140	9/64	25	
DLC156	5/32	25	
DLC187	3/16	25	
DLC218	7/32	10	
DLC250	1/4	10	
DLC312	5/16	5	
DLC375	3/8	5	
DLC437	7/16	1	
DLC500	1/2	1	
DLC562	9/16	1	
DLC625	5/8	1	
DLC750	3/4	1	
DLC875	7/8	1	
DLC100	1	1	
DLC1250	1 1/4	1	
DLC1500	1 1/2	1	
DLC2000	2	1	

## 12" LONG ARM HEX KEY

PLAIN FINISH - MADE IN THE U.S.A.

Line: 278-02

PART NUMBER	SIZE	QTY/BX	LIST PRICE
AJZ078	5/64 X 12	25	
AJZ093	3/32 X 12	25	
AJZ125	1/8 X 12	25	
AJZ156	5/32 X 12	25	
AJZ187	3/16 X 12	25	
AJZ218	7/32 X 12	25	
AJZ250	1/4 X 12	25	

## MULT-ANGLE BALL HEX KEY - STANDARD & METRIC SETS

PLAIN FINISH - MADE IN THE U.S.A.

Line: 278-03

PART NUMBER	SIZE	QTY/BX	LIST PRICE
AKD050	.050	5	
AKD062	1/16	5	
AKD078	5/64	5	
AKD093	3/32	5	
AKD109	7/64	5	
AKD125	1/8	5	
AKD140	9/64	5	
AKD156	5/32	5	
AKD187	3/16	5	
AKD218	7/32	5	
AKD250	1/4	5	
AKD312	5/16	5	
AKD375	3/8	5	
AKD500	1/2	2	
AKD015	MM 1.5 METRIC	5	
AKD02	MM 2.0 METRIC	5	
AKD025	MM 2.5 METRIC	5	
AKD03	MM 3.0	5	
AKD04	MM 4.0 METRIC	5	
AKD05	MM 5.0 METRIC	5	
AKD06	MM 6.0 METRIC	5	
AKD08	MM 8.0	5	
AKD10	MM 10.0	5	
AKD12	MM 12.0	1	
AKD14	MM 14.0	5	
AKD802	.050-5/16 32UB (12 PC. SET)	1	
AKD13213SET	.050-3/8 (13 PC. SET)	1	
AKD13216SET	.050-5/8 (16 PC. SET)	1	
AKD801	5/64-1/4 (7 PC. SET)	1	
AKD13613SET	M1.3-M17 (13 PC. SET)	1	
AKD801M	M1.5-M6 (7PC. SET)	1	
AKD802M	M1.5-M10 36MUB (9 PC. SET)	1	

## 6" LONG ARM HEX KEY

PLAIN FINISH - MADE IN THE U.S.A.

Line: 278-01

PART NUMBER	SIZE	QTY/BX	LIST PRICE
AJY078	5/64 X 6	25	
AJY093	3/32 X 6	25	
AJY109	7/64 X 6	25	
AJY125	1/8 X 6	25	
AJY140	9/64 X 6	25	
AJY156	5/32 X 6	25	
AJY187	3/16 X 6	25	
AJY218	7/32 X 6	25	
AJY250	1/4 X 6	25	
AJY312	5/16 X 6	25	
AJY375	3/8 X 6	25	



## METRIC SHORT ARM HEX KEY

PLAIN FINISH - DOMESTIC

Line: 278-04

PART NUMBER	SIZE	QTY/BX	LIST PRICE
AKE007	M0.7	25	
AKE009	M0.9	25	
AKE013	M1.3	25	
AKE015	M1.5	25	
AKE02	M2	25	
AKE025	M2.5	25	
AKE03	M3	25	
AKE04	M4	25	
AKE05	M5	25	
AKE06	M6	10	
AKE07	M7	10	
AKE08	M8	5	
AKE09	M9	5	
AKE10	M10	5	
AKE12	M12	5	
AKE14	M14	5	
AKE17	M17	1	
AKE19	M19	1	
AKE22	M22	1	

## METRIC LONG ARM HEX KEY

PLAIN FINISH - DOMESTIC

Line: 278-05

PART NUMBER	SIZE	QTY/BX	LIST PRICE
AKF009	M0.9	25	
AKF013	M1.3	25	
AKF015	M1.5	25	
AKF02	M2	25	
AKF025	M2.5	25	
AKF03	M3	25	
AKF04	M4	25	
AKF05	M5	25	
AKF06	M6	10	
AKF07	M7	10	
AKF08	M8	5	
AKF09	M9	5	
AKF10	M10	5	
AKF12	M12	5	
AKF14	M14	5	
AKF17	M17	1	
AKF19	M19	1	

## MULTI-ANGLE DRIVER BITS & SETS #800

PLAIN FINISH - DOMESTIC

Line: 278-07

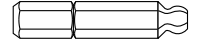

PART NUMBER	SIZE	QTY/BX	LIST PRICE
AKH093	3/32 DRIVER	1	
AKH109	7/64 DRIVER	1	
AKH125	1/8 DRIVER	1	
AKH140	9/64 DRIVER	1	
AKH800	9PC 5/64-1/4 SET	1	
AKH218	7/32 DRIVER	1	
AKH250	1/4 DRIVER	1	
AKH375	3/8 DRIVER	1	

## GLOBAL SHORT ARM HEX KEY - ALLOY

PLAIN FINISH

Line: 278-08

PART NUMBER	SIZE	QTY/BX	LIST PRICE
CFV028	.028	100	
CFV035	.035	100	
CFV050	.050	100	
CFV116	1/16	100	
CFV564	5/64	50	
CFV332	3/32	50	
CFV764	7/64	50	
CFV18	1/8	50	
CFV964	9/64	50	
CFV532	5/32	50	
CFV316	3/16	50	
CFV732	7/32	50	
CFV14	1/4	50	
CFV516	5/16	25	
CFV38	3/8	25	
CFV716	7/16	25	
CFV12	1/2	25	
CFV916	9/16	10	
CFV58	5/8	10	
CFV34	3/4	10	
CFV78	7/8	1	
CFV100	1	1	

## GLOBAL LONG ARM HEX KEY - ALLOY

PLAIN FINISH

Line: 278-09

PART NUMBER	SIZE	QTY/BX	LIST PRICE
CFW050	.050	50	
CFW116	1/16	50	
CFW564	5/64	50	
CFW332	3/32	50	
CFW764	7/64	50	
CFW18	1/8	50	
CFW964	9/64	50	

(continued...)

## GLOBAL LONG ARM HEX KEY - ALLOY (cont.)

PLAIN FINISH

Line: 278-09

PART NUMBER	SIZE	QTY/BX	LIST PRICE
CFW532	5/32	50	
CFW316	3/16	50	
CFW732	7/32	50	
CFW14	1/4	50	
CFW516	5/16	25	
CFW38	3/8	25	
CFW716	7/16	25	
CFW12	1/2	25	
CFW916	9/16	1	
CFW58	5/8	1	
CFW34	3/4	1	
CFW78	7/8	1	
CFW100	1	1	

## HEXAGON KEY CADDY/ISLANDS

STEEL

Line: 278-20

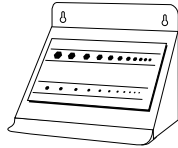

PART NUMBER	SIZE	QTY/BX	LIST PRICE
AJX665AIS	19PC .028-3/4 S/A	1	
ZWB13	050-3/8 MACIT CADDY	1	
AJX775MC	9PC M1.5-M10 L/A	1	
AJX775C	12PC 1/16-3/8 S/A	1	

## HEXAGON KEY SETS

PLASTIC POUCH - PLAIN FINISH - DOMESTIC

Line: 279-00

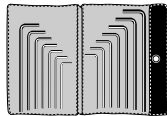

PART NUMBER	SIZE	QTY/BX	LIST PRICE
ZWB663	19PC.028-3/4 S/A27UB	1	
ZWB666	15PC.028-3/8 S/A17UB	1	
ZWB760	13PC .050-3/8S/A 2UB	1	
ZWB770	13PC .050-3/8 LA 3UB	1	
ZWB601	6PC.028-3/32 S/A 9UB	1	
ZWB605	6PC.050-5/32 S/A 7UB	1	
ZWB604	7PC 5/64-1/4S/A 13UB	1	
ZWB612	7PC5/64-1/412IN120UB	1	
ZWB7M	7PC M1.5-M6 (S/A)	1	
ZWB705	8PC .050-7/32S/A11UB	1	
ABM5SPS	9PC M1.5-M10.0 S/A	1	
ZWB616	9PC 5/64-3/8 6IN21UB	1	
ZWB664	9PC 5/64-1/4 S/A 1UB	1	
ZWB9M	9PC M1.5-M10S/A 25UB	1	
ZWB9ML	9PC M1.5-M10L/A 26UB	1	
ABM18SPS	11PC .050-1/4 L/A	1	
ZWB606	11PC.050-3/8 S/A15UB	1	
ZWB715	11PC5/64-9/16S/A16UB	1	
ZWB735	11PC5/64-3/8 6IN22UB	1	

## HEXAGON KEY SETS

METAL BOX - PLAIN FINISH - DOMESTIC

Line: 279-01

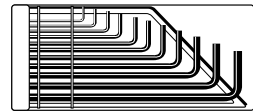

PART NUMBER	SIZE	QTY/BX	LIST PRICE
ALB15M	15PC M0.7-M17S/A53UB	1	
ALB668	15PC .028-3/8S/A50UB	1	
ALB675	14PC.050-1/2 SA	1	
ALB675M	10PC M1.5-M12L/A58UB	1	
ALB10M	12PC M0.7-M10S/A52UB	1	
ALB667	18PC .028-5/8S/A51UB	1	

## HEXAGON KEY SETS - DOMESTIC

PLASTIC BOX OR SLEEVE - PLAIN FINISH

Line: 279-02

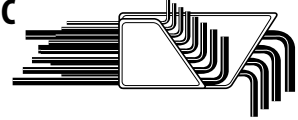

PART NUMBER	SIZE	QTY/BX	LIST PRICE
ABM608A	13PC .050-3/8S/A 4UB	1	
ABM741	13PC .050-3/8LA 6UB	1	
ABM9MA	9PC M1.5-M10S/A 8UB	1	

## T-HEX WRENCHES & SETS - DOMESTIC

CUSHION GRIP - PLAIN FINISH

METRIC AND STANDARD SIZES AVAILABLE

Line: 279-05

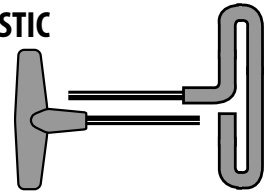

PART NUMBER	SIZE	QTY/BX	LIST PRICE
AKK025	M2.5 X 150MM	1	
AKK03	M3 X 150MM	1	
AKK04	M4 X 150MM	1	
AKK05	M5 X 150MM	1	
AKK06	M6 X 150MM	1	
AKK08	M8 X 150MM	1	
AKK10	M10 X 150MM	1	
AKK093	3/32 X 6 IN	1	
AKK109	7/64 X 6 IN	1	
AKK125	1/8 X 6 IN	1	
AKK780M	6PC-2.0-6MM SET	1	
AKK140	9/64 X 6 IN	1	
AKK156	5/32 X 6 IN	1	
AKK61810	5/32 X 9	1	
AKK780P	8PC 3/32-1/4 KIT	1	
AKK187	3/16 X 6 IN	1	
AKK780	10PC 3/32-3/8 SET	1	
AKK218	7/32 X 6 IN	1	
AKK250	1/4 X 6 IN	1	
AKK2509	1/4 X 9	1	
AKK61816	1/4 X 9	1	
AKK312	5/16 X 6 IN	1	
AKK3129	5/16 X 9	1	
AKK375	3/8 X 6 IN	1	
AKK437	7/16 X 6	1	

## T-HANDLE HEX KEY ALLOY

PLAIN FINISH - DOMESTIC

Line: 280-00

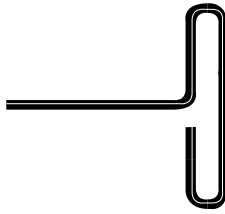

PART NUMBER	SIZE	QTY/BX	LIST PRICE
ZXB06-3	3/32 X 3	1	
ZXB06-6	3/32 X 6	1	
ZXB06-9	3/32 X 9	1	
ZXB07-3	7/64 X 3	1	
ZXB07-6	7/64 X 6	1	
ZXB07-9	7/64 X 9	1	
ZXB08-3	1/8 X 3	1	
ZXB08-6	1/8 X 6	1	
ZXB08-9	1/8 X 9	1	
ZXB09-3	9/64 X 3	1	
ZXB09-6	9/64 X 6	1	
ZXB09-9	9/64 X 9	1	
ZXB10-3	5/32 X 3	1	
ZXB10-6	5/32 X 6	1	
ZXB10-9	5/32 X 9	1	
ZXB12-3	3/16 X 3	1	
ZXB12-6	3/16 X 6	1	
ZXB12-9	3/16 X 9	1	
ZXB14-3	7/32 X 3	1	
ZXB14-6	7/32 X 6	1	
ZXB14-9	7/32 X 9	1	
ZXB16-3	1/4 X 3	1	
ZXB16-6	1/4 X 6	1	
ZXB16-9	1/4 X 9	1	
ZXB20-3	5/16 X 3	1	
ZXB20-6	5/16 X 6	1	
ZXB20-9	5/16 X 9	1	
ZXB24-3	3/8 X 3	1	
ZXB24-6	3/8 X 6	1	
ZXB24-9	3/8 X 9	1	

## FOLDING HEX KEY SET

PLAIN FINISH - DOMESTIC

Line: 281-00



PART NUMBER	SIZE	QTY/BX	LIST PRICE
ZYBM15	3-10 METRIC 21151EK	1	
ZYBM17	1.5-6 METRIC 21171EK	1	
ZYB20519	3/16-3/8 FOLD-A-BALL	1	
ZYB20719	1/16-5/32 FOLD-A-BALL	1	
ZYB20919	5/64-1/4 FOLD-A-BALL	1	
ZYB21158	M1.5-4.0 FOLD-A-BALL	1	
ZYB21159	M4-10 FOLD-A-BALL	1	
ZYB22571	T10-T40 TORX KEY	1	

(continued...)

## FOLDING HEX KEY SET (cont.)

PLAIN FINISH - DOMESTIC

Line: 281-00



PART NUMBER	SIZE	QTY/BX	LIST PRICE
ZYB25169	M2.0-M6.0 ERGO-FOLD	1	
ZYB25919	5/64-1/4 ERGO-FOLD	1	
ZYB51	3/16-3/8 20511EK	1	
ZYB81	.050-5/32 20811EK	1	
ZYB812	3/32-1/4 20812EK	1	
ZYB91	5/64-1/4 20911EK	1	
ZYB91S	.050-3/16 20912EK	1	
ZYB45SPS	7PC M2.0-M8.0 #45UB	1	
ZYB641HK	8 BIT .050-5/32 SET	1	

## T-HANDLE HEX KEY SET

PLAIN FINISH - DOMESTIC

Line: 282-00

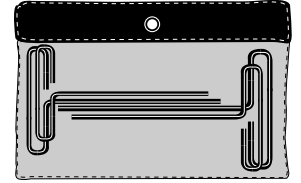

PART NUMBER	SIZE	QTY/BX	LIST PRICE
ZZB1396	3 - 10 PC 32130	1	
ZZB16192	6 - 10 PC 30160	1	
ZZB19288	9-10PC CUSH 50190	1	
ZZB33610	3/32 - 3/8 POUCH	1	
ZZB36168	6 8PC METRIC 2-10	1	
ZZB36198	9 8PC METRIC 2-10	1	
ZZB35168	2MM - 10MM POUCH	1	

## T-HANDLE HEX KEY SET STAND

Line: 282-01

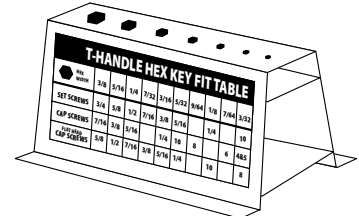

PART NUMBER	SIZE	QTY/BX	LIST PRICE
ZZB369	369	1	

## SOCKET PIPE PLUG - 3/4 TPR

ALLOY, PLAIN FINISH

Line: 283-00

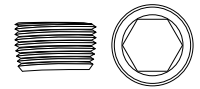

PART NUMBER	SIZE	QTY/BX	LIST PRICE
MEB01	1/16	100	
MEB02	1/8	100	
MEB04	1/4	100	
MEB06	3/8	100	
MEB08	1/2	50	
MEB12	3/4	50	
MEB16	1	25	
MEB20	1 1/4	25	

**SOCKET PIPE PLUG - 7/8 TPR**

ALLOY STEEL

Line: 284-00

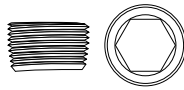

PART NUMBER	SIZE	QTY/BX	LIST PRICE
MFB01	1/16	100	
MFB16	1	25	
MFB02	1/8	100	
MFB04	1/4	100	
MFB06	3/8	100	
MFB08	1/2	50	
MFB12	3/4	50	
MFB20	1 1/4	25	

**SOCKET PIPE PLUG - 3/4 TPR**

STAINLESS STEEL

Line: 285-00

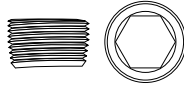

PART NUMBER	SIZE	QTY/BX	LIST PRICE
MGB01	1/16	100	
MGB02	1/8	100	
MGB04	1/4	100	
MGB06	3/8	100	
MGB08	1/2	100	

**SET SCREW SHAFT COLLAR**

STAINLESS STEEL

Line: 285-75

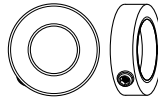

PART NUMBER	SIZE	QTY/BX	LIST PRICE
ASH02	1/8 C12S	4	
ASH03	3/16 C18S	4	
ASH04	1/4 C25S	4	
ASH05	5/16 C31S	4	
ASH06	3/8 C37S	4	
ASH07	7/16 C43S	2	
ASH08	1/2 C50S	2	
ASH09	9/16 C56S	2	
ASH10	5/8 C62S	2	
ASH11	11/16 C68S	2	
ASH12	3/4 C75S	2	
ASH13	13/16 C81S	2	
ASH14	7/8 C87S	2	
ASH15	15/16 C93S	2	
ASH16	1 C100S	2	
ASH17	1 1/16 C106S	1	
ASH18	1 1/8 C112S	1	
ASH19	1 3/16 C118S	1	
ASH20	1 1/4 C125S	1	
ASH21	1 5/16 C131S	1	
ASH22	1 3/8 C137S	1	
ASH23	1 7/16 C143S	1	
ASH24	1 1/2 C150S	1	
ASH25	1 9/16 C156S	1	

(continued...)

**SET SCREW SHAFT COLLAR**

STAINLESS STEEL

Line: 285-75

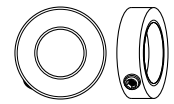

PART NUMBER	SIZE	QTY/BX	LIST PRICE
ASH26	1 5/8 C162S	1	
ASH27	1 11/16 C168S	1	
ASH28	1 3/4 C175S	1	
ASH29	1 7/8 C187S	1	
ASH30	1 15/16 C193S	1	
ASH32	2 C200S	1	
ASH34	2 1/8 C212S	1	
ASH36	2 1/4 C225S	1	
ASH38	2 7/16 C243S	1	
ASH40	2 1/2 C250S	1	

**ALLEN SOCKET NUT**

ALLOY STEEL

Line: 286-00



PART NUMBER	SIZE	QTY/BX	LIST PRICE
JHD03	10/24	100	
JHDS03	10/32	100	
JHD04	1/4-20	100	
JHDS04	1/4-28	100	
JHDS05X	5/16-18	100	
JHDS05X	5/16-24	25	
JHD06X	3/8-16	100	
JHDS06	3/8-24	25	
JHD07	7/16-14	25	
JHDS07	7/16-20	25	
JHD08	1/2-13	50	
JHDS08X	1/2-20	25	
JHD10	5/8-11	50	
JHDS10X	5/8-18	25	
JHDS12X	3/4-10	50	
JHD12	3/4-16	50	
JHDS14	7/8-14	10	
JHD14	7/8-9	10	
JHD16	1/8	25	
JHDS16	1-14	10	

**SET SCREW SHAFT COLLAR**

STEEL

Line: 286-01

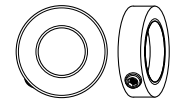

PART NUMBER	SIZE	QTY/BX	LIST PRICE
HED02	1/8	20	
HED03	3/16	20	
HED04	1/4	20	
HED05	5/16	20	
HED06	3/8	15	
HED07	7/16	15	
HED08	1/2	15	

(continued...)

### SET SCREW SHAFT COLLAR (cont.)

STEEL

Line: 286-01

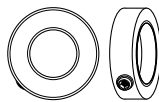

PART NUMBER	SIZE	QTY/BX	LIST PRICE
HED09	9/16	15	
HED10	5/8	15	
HED11	11/16	15	
HED12	3/4	10	
HED13	13/16	10	
HED14	7/8	10	
HED15	15/16	10	
HED16	1	10	
HED17	1 1/16	10	
HED18	1 1/8	10	
HED19	1 3/16	10	
HED20	1 1/4	10	
HED21	1 5/16	10	
HED22	1 3/8	10	
HED23	1 7/16	10	
HED24X	1 1/2	10	
HED25	1 9/16	5	
HED26	1 5/8	5	
HED27	1 11/16	5	
HED28	1 3/4	5	
HED29	1 13/16	5	
HED30	1 7/8	5	
HED31	1 15/16	5	
HED32	2	5	
HED34	2 1/8	1	
HED35	2 3/16	5	
HED36	2 1/4	5	
HED37	2 5/16	1	
HED38	2 3/8	1	
HED39	2 7/16	1	
HED40	2 1/2	1	
HED41	2 9/16	1	
HED43	2 11/16	1	
HED44	2 3/4	1	
HED47	2 15/16	1	
HED48	3	5	

### 1 PC. CLAMP SHAFT COLLAR (cont.)

STEEL

Line: 286-02

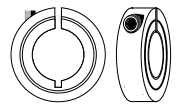

PART NUMBER	SIZE	QTY/BX	LIST PRICE
DRC08	1/2	20	
DRC09	9/16	10	
DRC10	5/8	10	
DRC11	11/16	10	
DRC12	3/4	10	
DRC13	13/16	10	
DRC14	7/8	10	
DRC15	15/16	10	
DRC16	1	10	
DRC17	1 1/16	5	
DRC18	1 1/8	5	
DRC19	1 3/16	5	
DRC20	1 1/4	5	
DRC21	1 5/16	5	
DRC22	1 3/8	5	
DRC23	1 7/16	5	
DRC24	1 1/2	5	
DRC25	1 9/16	5	
DRC26	1 5/8	5	
DRC27	1 11/16	5	
DRC28	1 3/4	5	
DRC30	1 7/8	5	
DRC31	1 15/16	5	
DRC32	2	5	
DRC35	2 3/16	5	
DRC36	2 1/4	1	
DRC38	2 3/8	1	
DRC39	2 7/16	1	
DRC40	2 1/2	1	
DRC44	2 3/4	1	
DRC48	3	1	

### 1 PC. CLAMP SHAFT COLLAR

STEEL

Line: 286-02

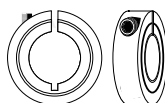

PART NUMBER	SIZE	QTY/BX	LIST PRICE
DRC02	1/8	20	
DRC03	3/16	20	
DRC04	1/4	20	
DRC05	5/16	20	
DRC06	3/8	20	
DRC07	7/16	20	

(continued...)

## 2 PC. CLAMP SHAFT COLLAR

STEEL

Line: 286-03

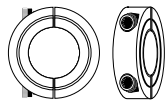

PART NUMBER	SIZE	QTY/BX	LIST PRICE
JND02	1/8	10	
JND03	3/16	10	
JND04	1/4	5	
JND05	5/16	5	
JND06	3/8	5	
JND07	7/16	5	
JND08	1/2	5	
JND09	9/16	5	
JND10X	5/8	5	
JND12	3/4	5	
JND14	7/8	5	
JND16	1	5	
JND17X	1 1/16	5	
JND18	1 1/8	5	
JND19	1 3/16	5	
JND20	1 1/4	5	
JND23	1 7/16	1	
JND24	1 1/2	1	
JND28	1 3/4	1	
JND30	1 7/8	1	
JND31	1 15/16	1	
JND32	2	1	
JND48	3	1	
JND56	3 1/2	1	

## 1 & 2 PC. CLAMP SHAFT COLLAR (cont.)

STAINLESS STEEL

Line: 286-04

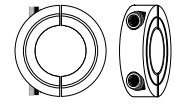

PART NUMBER	SIZE	QTY/BX	LIST PRICE
DSC402PC	2 1/2 (2 PIECE)	1	
DSC482PC	3" (2 PIECE)	1	
DSC04	1/4 (H1C025S)	4	
DSC05	5/16 (H1C031S)	4	
DSC06	3/8 (H1C037S)	4	
DSC08	1/2 (H1C050S)	2	
DSC10	5/8 (H1C062S)	2	
DSC12	3/4 (H1C075S)	2	
DSC14	7/8	2	
DSC16	1" (H1C100S)	2	
DSC32	2" (H1C200S)	1	
DSC48	3" (H1C300S)	1	

## SOCKET HEAD CAP SCREW

PLAIN FINISH- GLOBAL

Line: 286-05

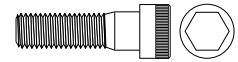

PART NUMBER	SIZE	QTY/BX	LIST PRICE
JMR00008	0/80 X 1/4	100	
JMR22006	2/56 X 3/16	100	
JMR22008	2/56 X 1/4	100	
JMR22012	2/56 X 3/8	100	
JMR22016	2/56 X 1/2	100	
JMR33006	3/48 X 3/16	100	
JMR33008	3/48 X 1/4	100	
JMR33012	3/48 X 3/8	100	
JMR33016	3/48 X 1/2	100	
JMR44004	4/40 X 1/8	100	
JMR44006	4/40 X 3/16	100	
JMR44008	4/40 X 1/4	100	
JMR44010	4/40 X 5/16	100	
JMR44012	4/40 X 3/8	100	
JMR44016	4/40 X 1/2	100	
JMR44020	4/40 X 5/8	100	
JMR44024	4/40 X 3/4	100	
JMR44032	4/40 X 1	100	
JMR44040	4/40 X 1 1/4	100	
JMR544008	4/48 X 1/4	100	
JMR544016	4/48 X 1/2	100	
JMR55008	5/40 X 1/4	100	
JMR55012	5/40 X 3/8	100	
JMR55016	5/40 X 1/2	100	
JMR55020	5/40 X 5/8	100	
JMR55024	5/40 X 3/4	100	
JMR55028	5/40 X 7/8	100	
JMR55032	5/40 X 1	100	
JMR66008	6/32 X 1/4	100	

## 1 & 2 PC. CLAMP SHAFT COLLAR

STAINLESS STEEL

Line: 286-04

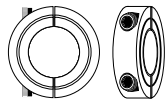

PART NUMBER	SIZE	QTY/BX	LIST PRICE
DSC042PC	1/4 (2 PIECE)	4	
DSC052PC	5/16 (2 PIECE)	4	
DSC062PC	3/8 (2 PIECE)	4	
DSC072PC	7/16 (2 PIECE)	2	
DSC082PC	1/2 (2 PIECE)	2	
DSC092PC	9/16 (2 PIECE)	2	
DSC102PC	5/8 (2 PIECE)	2	
DSC112PC	11/16 (2 PIECE)	2	
DSC122PC	3/4 (2 PIECE)	2	
DSC142PC	7/8 (2 PIECE)	1	
DSC162PC	1" (2 PIECE - TYPE S)	1	
DSC192PC	1 3/16 (2 PIECE)	1	
DSC20	1-1/4 (H1C125S)	1	
DSC202PC	1 1/4 (2 PIECE)	1	
DSC24	1-1/2 (H1C150S)	1	
DSC242PC	1 1/2 (2 PIECE)	1	
DSC322PC	2 (2 PIECE)	1	

(continued...)

(continued...)

**SOCKET HEAD CAP SCREW (cont.)**

PLAIN FINISH- GLOBAL

Line: 286-05

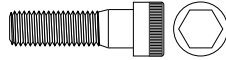

PART NUMBER	SIZE	QTY/BX	LIST PRICE
JMR66012	6/32 X 3/8	100	
JMR66016	6/32 X 1/2	100	
JMR66020	6/32 X 5/8	100	
JMR66024	6/32 X 3/4	100	
JMR66028	6/32 X 7/8	100	
JMR66032	6/32 X 1	100	
JMR66040	6/32 X 1 1/4	100	
JMR66048	6/32 X 1 1/2	100	
JMR66056	6/32 X 1 3/4	100	
JMR66064	6/32 X 2	100	
JMR66072	6/32 X 2 1/4	100	
JMR66080	6/32 X 2 1/2	100	
JMR66096	6/32 X 3	100	
JMRS66008	6/40 X 1/4	100	
JMRS66032	6/40 X 1	100	
JMR88006	8/32 X 3/16	100	
JMR88008	8/32 X 1/4	100	
JMR88012	8/32 X 3/8	100	
JMR88016	8/32 X 1/2	100	
JMR88020	8/32 X 5/8	100	
JMR88024	8/32 X 3/4	100	
JMR88028	8/32 X 7/8	100	
JMR88032	8/32 X 1	100	
JMR88040	8/32 X 1 1/4	100	
JMR88048	8/32 X 1 1/2	100	
JMR88056	8/32 X 1 3/4	100	
JMR88064	8/32 X 2	100	
JMR88096	8/32 X 3	100	
JMRS88008X	8/36 X 1/4	100	
JMRS88020	8/36 X 5/8	100	
JMRS88028	8/36 X 7/8	100	
JMRS88032	8/36 X 1	100	
JMRS88040	8/36 X 1 1/4	100	
JMRS88048	8/36 X 1 1/2	100	
JMRS88064	8/36 X 2	100	
JMR03008	10/24 X 1/4	100	
JMR03012	10/24 X 3/8	100	
JMR03016	10/24 X 1/2	100	
JMR03020	10/24 X 5/8	100	
JMR03024	10/24 X 3/4	100	
JMR03028	10/24 X 7/8	100	
JMR03032	10/24 X 1	100	
JMR03040	10/24 X 1 1/4	100	
JMR03048	10/24 X 1 1/2	100	
JMR03056	10/24 X 1 3/4	100	
JMR03064	10/24 X 2	100	

(continued...)

**SOCKET HEAD CAP SCREW (cont.)**

PLAIN FINISH- GLOBAL

Line: 286-05

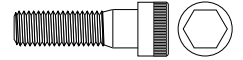

PART NUMBER	SIZE	QTY/BX	LIST PRICE
JMR03080	10/24 X 2 1/2	100	
JMR03088	10/24 X 2 3/4	100	
JMR03096	10/24 X 3	100	
JMR03112	10/24 X 3 1/2	100	
JMR03128	10/24 X 4	50	
JMR03144	10/24 X 4 1/2	50	
JMRS03006	10/32 X 3/16	100	
JMRS03008	10/32 X 1/4	100	
JMRS03010	10/32 X 5/16	100	
JMRS03012	10/32 X 3/8	100	
JMRS03016	10/32 X 1/2	100	
JMRS03020	10/32 X 5/8	100	
JMRS03024	10/32 X 3/4	100	
JMRS03028	10/32 X 7/8	100	
JMRS03032	10/32 X 1	100	
JMRS03040	10/32 X 1 1/4	100	
JMRS03044	10/32 X 1 3/8	100	
JMRS03048	10/32 X 1 1/2	100	
JMRS03056	10/32 X 1 3/4	100	
JMRS03064	10/32 X 2	100	
JMR21012	12/24 X 3/8	100	
JMR21032	12/24 X 1	100	
JMR21048	12/24 X 1 1/2	100	
JMR04008	1/4-20 X 1/4	100	
JMR04012	1/4-20 X 3/8	100	
JMR04016	1/4-20 X 1/2	100	
JMR04020	1/4-20 X 5/8	100	
JMR04024	1/4-20 X 3/4	100	
JMR04028	1/4-20 X 7/8	100	
JMR04032	1/4-20 X 1	100	
JMR04036	1/4-20 X 1 1/8	100	
JMR04040	1/4-20 X 1 1/4	100	
JMR04048	1/4-20 X 1 1/2	100	
JMR04052	1/4-20 X 1 5/8	100	
JMR04056	1/4-20 X 1 3/4	100	
JMR04064	1/4-20 X 2	100	
JMR04072	1/4-20 X 2 1/4	100	
JMR04080	1/4-20 X 2 1/2	50	
JMR04088	1/4-20 X 2 3/4	50	
JMR04096	1/4-20 X 3	50	
JMR04104	1/4-20 X 3 1/4	50	
JMR04112	1/4-20 X 3 1/2	50	
JMR04120	1/4-20 X 3 3/4	50	
JMR04128	1/4-20 X 4	50	
JMR04160	1/4-20 X 5	50	
JMR04176	1/4-20 X 5 1/2	50	

(continued...)

**SOCKET HEAD CAP SCREW (cont.)**

PLAIN FINISH- GLOBAL

Line: 286-05

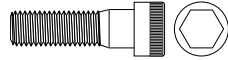

PART NUMBER	SIZE	QTY/BX	LIST PRICE
JMR04192	1/4-20 X 6	25	
JMRS04008	1/4-28 X 1/4	100	
JMRS04012	1/4-28 X 3/8	100	
JMRS04016	1/4-28 X 1/2	100	
JMRS04020	1/4-28 X 5/8	100	
JMRS04024	1/4-28 X 3/4	100	
JMRS04028	1/4-28 X 7/8	100	
JMRS04032	1/4-28 X 1	100	
JMRS04040	1/4-28 X 1 1/4	100	
JMRS04048	1/4-28 X 1 1/2	100	
JMRS04056	1/4-28 X 1 3/4	100	
JMRS04064	1/4-28 X 2	100	
JMRS04072	1/4-28 X 2 1/4	100	
JMRS04080	1/4-28 X 2 1/2	50	
JMRS04096	1/4-28 X 3	50	
JMRS04144	1/4-28 X 4 1/2	50	
JMR05012	5/16-18 X 3/8	100	
JMR05016	5/16-18 X 1/2	100	
JMR05020	5/16-18 X 5/8	100	
JMR05024	5/16-18 X 3/4	100	
JMR05028	5/16-18 X 7/8	100	
JMR05032	5/16-18 X 1	100	
JMR05036	5/16-18 X 1 1/8	100	
JMR05040	5/16-18 X 1 1/4	100	
JMR05048	5/16-18 X 1 1/2	100	
JMR05056	5/16-18 X 1 3/4	100	
JMR05064	5/16-18 X 2	100	
JMR05072	5/16-18 X 2 1/4	50	
JMR05080	5/16-18 X 2 1/2	50	
JMR05088	5/16-18 X 2 3/4	50	
JMR05096	5/16-18 X 3	50	
JMR05104	5/16-18 X 3 1/4	50	
JMR05112	5/16-18 X 3 1/2	50	
JMR05120	5/16-18 X 3 3/4	50	
JMR05128	5/16-18 X 4	50	
JMR05144	5/16-18 X 4 1/2	50	
JMR05160	5/16-18 X 5	50	
JMR05176	5/16-18 X 5 1/2	25	
JMR05192	5/16-18 X 6	25	
JMRS05016	5/16-24 X 1/2	100	
JMRS05020	5/16-24 X 5/8	100	
JMRS05024	5/16-24 X 3/4	100	
JMRS05028	5/16-24 X 7/8	100	
JMRS05032	5/16-24 X 1	100	
JMRS05040	5/16-24 X 1 1/4	100	
JMRS05048	5/16-24 X 1 1/2	100	

(continued...)

**SOCKET HEAD CAP SCREW (cont.)**

PLAIN FINISH- GLOBAL

Line: 286-05

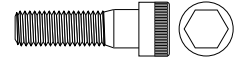

PART NUMBER	SIZE	QTY/BX	LIST PRICE
JMRS05056	5/16-24 X 1 3/4	100	
JMRS05064	5/16-24 X 2	100	
JMRS05072	5/16-24 X 2 1/4	50	
JMRS05080	5/16-24 X 2 1/2	50	
JMRS05096	5/16-24 X 3	50	
JMRS05112	5/16-24 X 3 1/2	50	
JMRS05128	5/16-24 X 4	50	
JMR06012	3/8-16 X 3/8	100	
JMR06016	3/8-16 X 1/2	100	
JMR06020	3/8-16 X 5/8	100	
JMR06024	3/8-16 X 3/4	100	
JMR06028	3/8-16 X 7/8	100	
JMR06032	3/8-16 X 1	100	
JMR06040	3/8-16 X 1 1/4	100	
JMR06044	3/8-16 X 1 3/8	100	
JMR06048	3/8-16 X 1 1/2	100	
JMR06056	3/8-16 X 1 3/4	50	
JMR06064	3/8-16 X 2	50	
JMR06072	3/8-16 X 2 1/4	50	
JMR06080	3/8-16 X 2 1/2	50	
JMR06088	3/8-16 X 2 3/4	50	
JMR06096	3/8-16 X 3	50	
JMR06104	3/8-16 X 3 1/4	50	
JMR06112	3/8-16 X 3 1/2	25	
JMR06120	3/8-16 X 3 3/4	25	
JMR06128	3/8-16 X 4	25	
JMR06136	3/8-16 X 4 1/4	25	
JMR06144	3/8-16 X 4 1/2	25	
JMR06160	3/8-16 X 5	25	
JMR06176	3/8-16 X 5 1/2	25	
JMR06192	3/8-16 X 6	25	
JMR06224	3/8-16 X 7	25	
JMR06256	3/8-16 X 8	25	
JMRS06016	3/8-24 X 1/2	100	
JMRS06020	3/8-24 X 5/8	100	
JMRS06024	3/8-24 X 3/4	100	
JMRS06028	3/8-24 X 7/8	100	
JMRS06032	3/8-24 X 1	100	
JMRS06040	3/8-24 X 1 1/4	100	
JMRS06048	3/8-24 X 1 1/2	100	
JMRS06056	3/8-24 X 1 3/4	50	
JMRS06064	3/8-24 X 2	50	
JMRS06072	3/8-24 X 2 1/4	50	
JMRS06080	3/8-24 X 2 1/2	50	
JMRS06088	3/8-24 X 2 3/4	50	
JMRS06096	3/8-24 X 3	50	

(continued...)



## SOCKET HEAD CAP SCREW (cont.)

PLAIN FINISH- GLOBAL

Line: 286-05

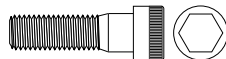

PART NUMBER	SIZE	QTY/BX	LIST PRICE
JMRS06112	3/8-24 X 3 1/2	25	
JMRS06128	3/8-24 X 4	25	
JMRS06144	3/8-24 X 4 1/2	25	
JMRS06160	3/8-24 X 5	25	
JMRS06192	3/8-24 X 6	25	
JMR07024	7/16-14 X 3/4	100	
JMR07028	7/16-14 X 7/8	100	
JMR07032	7/16-14 X 1	50	
JMR07040	7/16-14 X 1 1/4	50	
JMR07044	7/16-14 X 1 3/8	50	
JMR07048	7/16-14 X 1 1/2	50	
JMR07056	7/16-14 X 1 3/4	50	
JMR07064	7/16-14 X 2	50	
JMR07072	7/16-14 X 2 1/4	50	
JMR07080	7/16-14 X 2 1/2	25	
JMR07088	7/16-14 X 2 3/4	25	
JMR07096	7/16-14 X 3	25	
JMR07112	7/16-14 X 3 1/2	25	
JMR07128	7/16-14 X 4	25	
JMR07144	7/16-14 X 4 1/2	25	
JMR07192	7/16-14 X 6	25	
JMRS07016	7/16-20 X 1/2	50	
JMRS07032	7/16-20 X 1	50	
JMRS07040	7/16-20 X 1 1/4	50	
JMRS07048	7/16-20 X 1 1/2	50	
JMRS07056	7/16-20 X 1 3/4	50	
JMRS07064	7/16-20 X 2	50	
JMR08016	1/2-13 X 1/2	50	
JMR08024X	1/2-13 X 3/4	50	
JMR08028	1/2-13 X 7/8	50	
JMR08032	1/2-13 X 1	50	
JMR08040	1/2-13 X 1 1/4	50	
JMR08048	1/2-13 X 1 1/2	50	
JMR08056	1/2-13 X 1 3/4	50	
JMR08064	1/2-13 X 2	50	
JMR08072	1/2-13 X 2 1/4	25	
JMR08080	1/2-13 X 2 1/2	25	
JMR08088	1/2-13 X 2 3/4	25	
JMR08096	1/2-13 X 3	25	
JMR08104	1/2-13 X 3 1/4	25	
JMR08112	1/2-13 X 3 1/2	25	
JMR08120	1/2-13 X 3 3/4	25	
JMR08128	1/2-13 X 4	25	
JMR08160	1/2-13 X 5	25	
JMR08176	1/2-13 X 5 1/2	25	
JMR08192	1/2-13 X 6	25	

(continued...)

## SOCKET HEAD CAP SCREW (cont.)

PLAIN FINISH- GLOBAL

Line: 286-05

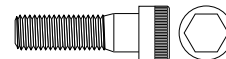

PART NUMBER	SIZE	QTY/BX	LIST PRICE
JMR08208	1/2-13 X 6 1/2	25	
JMR08224	1/2-13 X 7	25	
JMR08240	1/2-13 X 7 1/2	10	
JMR08256	1/2-13 X 8	25	
JMR08272	1/2-13 X 8 1/2	10	
JMR08288	1/2-13 X 9	10	
JMRS08024	1/2-20 X 3/4	50	
JMRS08032	1/2-20 X 1	50	
JMRS08040	1/2-20 X 1 1/4	50	
JMRS08048	1/2-20 X 1 1/2	50	
JMRS08056	1/2-20 X 1 3/4	50	
JMRS08064	1/2-20 X 2	50	
JMRS08072	1/2-20 X 2 1/4	25	
JMRS08080	1/2-20 X 2 1/2	25	
JMRS08088	1/2-20 X 2 3/4	25	
JMRS08096	1/2-20 X 3	25	
JMRS08112X	1/2-20 X 3 1/2	25	
JMRS08128X	1/2-20 X 4	25	
JMRS08144	1/2-20 X 4 1/2	25	
JMRS08160	1/2-20 X 5	25	
JMRS08192	1/2-20 X 6	25	
JMR09096	9/16-12 X 3	25	
JMR09128	9/16-12 X 4	25	
JMR09160	9/16-12 X 5	25	
JMR10024	5/8-11 X 3/4	25	
JMR10032	5/8-11 X 1	25	
JMR10040	5/8-11 X 1 1/4	25	
JMR10048	5/8-11 X 1 1/2	25	
JMR10056	5/8-11 X 1 3/4	25	
JMR10064	5/8-11 X 2	25	
JMR10072	5/8-11 X 2 1/4	25	
JMR10080	5/8-11 X 2 1/2	25	
JMR10088	5/8-11 X 2 3/4	25	
JMR10096	5/8-11 X 3	25	
JMR10104	5/8-11 X 3 1/4	25	
JMR10112	5/8-11 X 3 1/2	25	
JMR10128	5/8-11 X 4	25	
JMR10136	5/8-11 X 4 1/4	25	
JMR10144	5/8-11 X 4 1/2	25	
JMR10160	5/8-11 X 5	25	
JMR10176	5/8-11 X 5 1/2	25	
JMR10192	5/8-11 X 6	25	
JMR10208	5/8-11 X 6 1/2	10	
JMR10224	5/8-11 X 7	10	
JMR10256	5/8-11 X 8	10	
JMR10352	5/8-11 X 11	10	

(continued...)

## SOCKET HEAD CAP SCREW (cont.)

PLAIN FINISH- GLOBAL

Line: 286-05

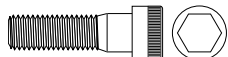

PART NUMBER	SIZE	QTY/BX	LIST PRICE
JMR10384	5/8-11 X 12	10	
JMRS10032	5/8-18 X 1	25	
JMRS10040	5/8-18 X 1 1/4	25	
JMRS10048	5/8-18 X 1 1/2	25	
JMRS10056	5/8-18 X 1 3/4	25	
JMRS10064	5/8-18 X 2	25	
JMRS10072X	5/8-18 X 2 1/4	25	
JMRS10080	5/8-18 X 2 1/2	25	
JMRS10088X	5/8-18 X 2 3/4	25	
JMRS10096X	5/8-18 X 3	25	
JMRS10104X	5/8-18 X 3 1/4	25	
JMRS10112X	5/8-18 X 3 1/2	25	
JMRS10128X	5/8-18 X 4	25	
JMRS10144	5/8-18 X 4 1/2	25	
JMRS10160	5/8-18 X 5	25	
JMRS10176	5/8-18 X 5 1/2	25	
JMRS10192	5/8-18 X 6	25	
JMR12040	3/4-10 X 1 1/4	25	
JMR12048	3/4-10 X 1 1/2	25	
JMR12056	3/4-10 X 1 3/4	25	
JMR12064	3/4-10 X 2	25	
JMR12072	3/4-10 X 2 1/4	25	
JMR12080	3/4-10 X 2 1/2	25	
JMR12088	3/4-10 X 2 3/4	25	
JMR12096	3/4-10 X 3	25	
JMR12104	3/4-10 X 3 1/4	25	
JMR12112	3/4-10 X 3 1/2	25	
JMR12120	3/4-10 X 3 3/4	25	
JMR12128	3/4-10 X 4	25	
JMR12144	3/4-10 X 4 1/2	25	
JMR12152	3/4-10 X 4 3/4	25	
JMR12160	3/4-10 X 5	10	
JMR12176	3/4-10 X 5 1/2	10	
JMR12192	3/4-10 X 6	10	
JMR12208	3/4-10 X 6 1/2	10	
JMR12224	3/4-10 X 7	10	
JMR12256	3/4-10 X 8	10	
JMR12304	3/4-10 X 9 1/2	10	
JMRS12032	3/4-16 X 1	25	
JMRS12048X	3/4-16 X 1 1/2	25	
JMRS12056X	3/4-16 X 1 3/4	25	
JMRS12064X	3/4-16 X 2	25	
JMRS12072X	3/4-16 X 2 1/4	25	
JMRS12080X	3/4-16 X 2 1/2	25	
JMRS12088X	3/4-16 X 2 3/4	25	
JMRS12096X	3/4-16 X 3	25	

(continued...)

## SOCKET HEAD CAP SCREW (cont.)

PLAIN FINISH- GLOBAL

Line: 286-05

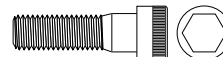

PART NUMBER	SIZE	QTY/BX	LIST PRICE
JMRS12112X	3/4-16 X 3 1/2	25	
JMRS12128X	3/4-16 X 4	25	
JMRS12144X	3/4-16 X 4 1/2	25	
JMRS12160X	3/4-16 X 5	10	
JMRS12192X	3/4-16 X 6	10	
JMRS14056	7/8-14 X 1 3/4	10	
JMRS14064X	7/8-14 X 2	10	
JMRS14080X	7/8-14 X 2 1/2	10	
JMRS14096X	7/8-14 X 3	10	
JMRS14112X	7/8-14 X 3 1/2	10	
JMRS14128X	7/8-14 X 4	10	
JMR14064	7/8-9 X 2	10	
JMR14072	7/8-9 X 2 1/4	10	
JMR14080	7/8-9 X 2 1/2	10	
JMR14088	7/8-9 X 2 3/4	10	
JMR14096	7/8-9 X 3	10	
JMR14104	7/8-9 X 3 1/4	10	
JMR14112	7/8-9 X 3 1/2	10	
JMR14128	7/8-9 X 4	10	
JMR14144	7/8-9 X 4 1/2	10	
JMR14160	7/8-9 X 5	10	
JMR14176	7/8-9 X 5 1/2	10	
JMR14192	7/8-9 X 6	10	
JMR14208	7/8-9 X 6 1/2	10	
JMR14224	7/8-9 X 7	10	
JMR14256	7/8-9 X 8	10	
JMR14288	7/8-9 X 9	10	
JMR16064	1-8 X 2	10	
JMR16072	1-8 X 2 1/4	10	
JMR16080	1-8 X 2 1/2	10	
JMR16088	1-8 X 2 3/4	10	
JMR16096	1-8 X 3	10	
JMR16104	1-8 X 3 1/4	10	
JMR16112	1-8 X 3 1/2	10	
JMR16128	1-8 X 4	10	
JMR16144	1-8 X 4 1/2	10	
JMR16160	1-8 X 5	10	
JMR16176	1-8 X 5 1/2	10	
JMR16192	1-8 X 6	10	
JMR16208	1-8 X 6 1/2	10	
JMR16224	1-8 X 7	10	
JMR16240	1-8 X 7 1/2	10	
JMR16256	1-8 X 8	10	
JMR16384	1-8 X 12	1	
JMR16448	1-8 X 14	1	
JMRSS16096	1-12 X 3	5	

(continued...)

## SOCKET HEAD CAP SCREW (cont.)

PLAIN FINISH- GLOBAL

Line: 286-05

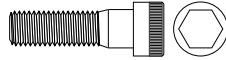

PART NUMBER	SIZE	QTY/BX	LIST PRICE
JMRS16064X	1-14 X 2	5	
JMRS16080X	1-14 X 2 1/2	5	
JMRS16096X	1-14 X 3	5	
JMRS16112X	1-14 X 3 1/2	5	
JMRS16128X	1-14 X 4	5	
JMRS16144X	1-14 X 4 1/2	5	
JMRS16160X	1-14 X 5	5	
JMRS16192X	1-14 X 6	5	
JMR18096	1 1/8-7 X 3	10	
JMR20192	1 1/4-7 X 6	1	
JMR20224	1 1/4-7 X 7	1	
JMR20288	1 1/4-7 X 9	1	
JMRS20160	1 1/4-12 X 5	1	
JMR24096	1 1/2-6 X 3	1	
JMR24144	1 1/2-6 X 4 1/2	1	
JMR24176	1 1/2-6 X 5 1/2	5	
JMR24256	1 1/2-6 X 8	1	
JMR24384	1 1/2-6 X 12	1	

## SOCKET SET SCREW - CUP POINT

PLAIN FINISH- GLOBAL

Line: 286-06

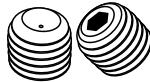

PART NUMBER	SIZE	QTY/BX	LIST PRICE
JNR22003	2/56 X 3/32	100	
JNR22004	2/56 X 1/8	100	
JNR22008	2/56 X 1/4	100	
JNR33003	3/48 X 3/32	100	
JNR33006	3/48 X 3/16	100	
JNR44004	4/40 X 1/8	100	
JNR44006	4/40 X 3/16	100	
JNR44008	4/40 X 1/4	100	
JNR44010	4/40 X 5/16	100	
JNR44012	4/40 X 3/8	100	
JNR44014	4/40 X 7/16	100	
JNR44016	4/40 X 1/2	100	
JNR44020	4/40 X 5/8	100	
JNR55004	5/40 X 1/8	100	
JNR55006	5/40 X 3/16	100	
JNR55008	5/40 X 1/4	100	
JNR55010	5/40 X 5/16	100	
JNR55012	5/40 X 3/8	100	
JNR55014	5/40 X 7/16	100	

(continued...)

## SOCKET SET SCREW - CUP POINT (cont.)

PLAIN FINISH- GLOBAL

Line: 286-06

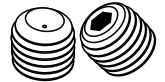

PART NUMBER	SIZE	QTY/BX	LIST PRICE
JNR55016	5/40 X 1/2	100	
JNR55020	5/40 X 5/8	100	
JNR55024	5/40 X 3/4	100	
JNR66004	6/32 X 1/8	100	
JNR66006	6/32 X 3/16	100	
JNR66008	6/32 X 1/4	100	
JNR66010	6/32 X 5/16	100	
JNR66012	6/32 X 3/8	100	
JNR66014	6/32 X 7/16	100	
JNR66016	6/32 X 1/2	100	
JNR66020	6/32 X 5/8	100	
JNR66024	6/32 X 3/4	100	
JNR66032	6/32 X 1	100	
JNRS66004	6/40 X 1/8	100	
JNRS66008	6/40 X 1/4	100	
JNRS66012	6/40 X 3/8	100	
JNR88004	8/32 X 1/8	100	
JNR88006	8/32 X 3/16	100	
JNR88008	8/32 X 1/4	100	
JNR88010	8/32 X 5/16	100	
JNR88012	8/32 X 3/8	100	
JNR88014	8/32 X 7/16	100	
JNR88016	8/32 X 1/2	100	
JNR88020	8/32 X 5/8	100	
JNR88024	8/32 X 3/4	100	
JNR88028	8/32 X 7/8	100	
JNR88032X	8/32 X 1	100	
JNRS88006	8/36 X 3/16	100	
JNRS88008	8/36 X 1/4	100	
JNRS88010	8/36 X 5/16	100	
JNRS88012	8/36 X 3/8	100	
JNR03004	10/24 X 1/8	100	
JNR03006	10/24 X 3/16	100	
JNR03008	10/24 X 1/4	100	
JNR03010	10/24 X 5/16	100	
JNR03012	10/24 X 3/8	100	
JNR03014	10/24 X 7/16	100	
JNR03016	10/24 X 1/2	100	
JNR03020	10/24 X 5/8	100	
JNR03024	10/24 X 3/4	100	
JNR03028	10/24 X 7/8	100	
JNR03032	10/24 X 1	100	
JNR03040	10/24 X 1 1/4	100	
JNRS03004	10/32 X 1/8	100	
JNRS03006	10/32 X 3/16	100	
JNRS03008	10/32 X 1/4	100	

(continued...)

**SOCKET SET SCREW - CUP POINT (cont.)**

PLAIN FINISH- GLOBAL

Line: 286-06

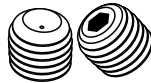

PART NUMBER	SIZE	QTY/BX	LIST PRICE
JNRS03010	10/32 X 5/16	100	
JNRS03012	10/32 X 3/8	100	
JNRS03014	10/32 X 7/16	100	
JNRS03016	10/32 X 1/2	100	
JNRS03020	10/32 X 5/8	100	
JNRS03024	10/32 X 3/4	100	
JNRS03028	10/32 X 7/8	100	
JNRS03032	10/32 X 1	100	
JNRS03040	10/32 X 1 1/4	100	
JNRS03048	10/32 X 1 1/2	100	
JNR21016	12/24 X 1/2	100	
JNR04006	1/4-20 X 3/16	100	
JNR04008	1/4-20 X 1/4	100	
JNR04010	1/4-20 X 5/16	100	
JNR04012	1/4-20 X 3/8	100	
JNR04014	1/4-20 X 7/16	100	
JNR04016	1/4-20 X 1/2	100	
JNR04020	1/4-20 X 5/8	100	
JNR04024	1/4-20 X 3/4	100	
JNR04028	1/4-20 X 7/8	100	
JNR04032	1/4-20 X 1	100	
JNR04040	1/4-20 X 1 1/4	100	
JNR04048	1/4-20 X 1 1/2	100	
JNR04056	1/4-20 X 1 3/4	100	
JNR04064	1/4-20 X 2	100	
JNR04096	1/4-20 X 3	100	
JNRS04006	1/4-28 X 3/16	100	
JNRS04008	1/4-28 X 1/4	100	
JNRS04010	1/4-28 X 5/16	100	
JNRS04012	1/4-28 X 3/8	100	
JNRS04016	1/4-28 X 1/2	100	
JNRS04020	1/4-28 X 5/8	100	
JNRS04024	1/4-28 X 3/4	100	
JNRS04032	1/4-28 X 1	100	
JNRS04040	1/4-28 X 1 1/4	100	
JNR05006	5/16-18X 3/16	100	
JNR05008	5/16-18 X 1/4	100	
JNR05010	5/16-18 X 5/16	100	
JNR05012	5/16-18 X 3/8	100	
JNR05014	5/16-18 X 7/16	100	
JNR05016	5/16-18 X 1/2	100	
JNR05020	5/16-18 X 5/8	100	
JNR05024	5/16-18 X 3/4	100	
JNR05028	5/16-18 X 7/8	100	
JNR05032	5/16-18 X 1	100	
JNR05040	5/16-18 X 1 1/4	100	

(continued...)

**SOCKET SET SCREW - CUP POINT (cont.)**

PLAIN FINISH- GLOBAL

Line: 286-06

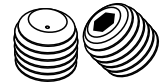

PART NUMBER	SIZE	QTY/BX	LIST PRICE
JNR05048	5/16-18 X 1 1/2	50	
JNRS05056	5/16-18 X 1 3/4	50	
JNRS05064	5/16-18 X 2	50	
JNRS05008	5/16-24 X 1/4	100	
JNRS05010	5/16-24 X 5/16	100	
JNRS05012	5/16-24 X 3/8	100	
JNRS05016	5/16-24 X 1/2	100	
JNRS05020	5/16-24 X 5/8	100	
JNRS05024	5/16-24 X 3/4	100	
JNRS05032	5/16-24 X 1	100	
JNRS05040	5/16-24 X 1 1/4	100	
JNRS05048	5/16-24 X 1 1/2	100	
JNR06008	3/8-16 X 1/4	100	
JNR06010	3/8-16 X 5/16	100	
JNR06012	3/8-16 X 3/8	100	
JNR06014	3/8-16 X 7/16	100	
JNR06016	3/8-16 X 1/2	100	
JNR06020	3/8-16 X 5/8	100	
JNR06024	3/8-16 X 3/4	100	
JNR06028	3/8-16 X 7/8	100	
JNR06032	3/8-16 X 1	100	
JNR06040	3/8-16 X 1 1/4	100	
JNR06048	3/8-16 X 1 1/2	100	
JNR06056	3/8-16 X 1 3/4	50	
JNR06064	3/8-16 X 2	50	
JNR06080	3/8-16 X 2 1/2	50	
JNRS06008	3/8-24 X 1/4	100	
JNRS06010	3/8-24 X 5/16	100	
JNRS06012	3/8-24 X 3/8	100	
JNRS06014	3/8-24 X 7/16	100	
JNRS06016	3/8-24 X 1/2	100	
JNRS06020	3/8-24 X 5/8	100	
JNRS06024	3/8-24 X 3/4	100	
JNRS06032	3/8-24 X 1	100	
JNRS06040	3/8-24 X 1 1/4	100	
JNRS06048	3/8-24 X 1 1/2	100	
JNRS06064	3/8-24 X 2	100	
JNRS06080	3/8-24 X 2 1/2	50	
JNR07012	7/16-14 X 3/8	100	
JNR07014	7/16-14 X 7/16	100	
JNR07016	7/16-14 X 1/2	100	
JNR07020	7/16-14 X 5/8	100	
JNR07024	7/16-14 X 3/4	100	
JNR07028	7/16-14 X 7/8	50	
JNR07032	7/16-14 X 1	50	
JNR07040	7/16-14 X 1 1/4	50	

(continued...)

## SOCKET SET SCREW - CUP POINT (cont.)

PLAIN FINISH- GLOBAL

Line: 286-06

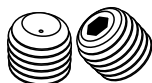

PART NUMBER	SIZE	QTY/BX	LIST PRICE
JNR07048	7/16-14 X 1 1/2	50	
JNR07064	7/16-14 X 2	50	
JNRS07012	7/16-20 X 3/8	100	
JNRS07014	7/16-20 X 7/16	100	
JNRS07016	7/16-20 X 1/2	100	
JNRS07064	7/16-20 X 2	50	
JNR08012	1/2-13 X 3/8	100	
JNR08014	1/2-13 X 7/16	100	
JNR08016	1/2-13 X 1/2	100	
JNR08020	1/2-13 X 5/8	100	
JNR08024	1/2-13 X 3/4	100	
JNR08028	1/2-13 X 7/8	50	
JNR08032	1/2-13 X 1	50	
JNR08040	1/2-13 X 1 1/4	50	
JNR08048	1/2-13 X 1 1/2	50	
JNR08056	1/2-13 X 1 3/4	50	
JNR08064	1/2-13 X 2	50	
JNR08080	1/2-13 X 2 1/2	25	
JNR08096	1/2-13 X 3	25	
JNRS08012	1/2-20 X 3/8	100	
JNRS08016	1/2-20 X 1/2	100	
JNRS08020	1/2-20 X 5/8	100	
JNRS08024	1/2-20 X 3/4	100	
JNRS08032	1/2-20 X 1	50	
JNRS08048	1/2-20 X 1 1/2	50	
JNRS08080	1/2-20 X 2 1/2	50	
JNR09024	9/16-12 X 3/4	50	
JNR10016	5/8-11 X 1/2	50	
JNR10020	5/8-11 X 5/8	50	
JNR10024	5/8-11 X 3/4	50	
JNR10028	5/8-11 X 7/8	50	
JNR10032	5/8-11 X 1	25	
JNR10040	5/8-11 X 1 1/4	25	
JNR10048	5/8-11 X 1 1/2	25	
JNR10056	5/8-11 X 1 3/4	25	
JNR10064	5/8-11 X 2	25	
JNR10080	5/8-11 X 2 1/2	25	
JNR10096	5/8-11 X 3	25	
JNRS10016	5/8-18 X 1/2	50	
JNRS10020	5/8-18 X 5/8	50	
JNRS10024	5/8-18 X 3/4	50	
JNRS10032	5/8-18 X 1	50	
JNRS10040X	5/8-18 X 1 1/4	25	
JNRS10064	5/8-18 X 2	25	
JNR12016	3/4-10 X 1/2	50	
JNR12020	3/4-10 X 5/8	50	

(continued...)

## SOCKET SET SCREW - CUP POINT (cont.)

PLAIN FINISH- GLOBAL

Line: 286-06

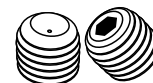

PART NUMBER	SIZE	QTY/BX	LIST PRICE
JNR12024	3/4-10 X 3/4	50	
JNR12028X	3/4-10 X 7/8	25	
JNR12032	3/4-10 X 1	25	
JNR12040	3/4-10 X 1 1/4	25	
JNR12048	3/4-10 X 1 1/2	25	
JNR12056	3/4-10 X 1 3/4	10	
JNR12064	3/4-10 X 2	10	
JNR12080	3/4-10 X 2 1/2	10	
JNR12096	3/4-10 X 3	10	
JNR12128	3/4-10 X 4	25	
JNRS12016	3/4-16 X 1/2	50	
JNRS12024	3/4-16 X 3/4	50	
JNRS14032	7/8-14 X 1	25	
JNR14028	7/8-9 X 7/8	25	
JNR14032	7/8-9 X 1	25	
JNR14040	7/8-9 X 1 1/4	25	
JNR14048	7/8-9 X 1 1/2	25	
JNR14064	7/8-9 X 2	25	
JNR14080	7/8-9 X 2 1/2	25	
JNR14096	7/8-9 X 3	25	
JNR16032	1-8 X 1	10	
JNR16048	1-8 X 1 1/2	10	
JNR16064	1-8 X 2	10	
JNR16080	1-8 X 2 1/2	10	
JNR16096	1-8 X 3	10	

# FLAT SOCKET CAP SCREW

PLAIN FINISH- GLOBAL

Line: 286-07

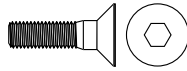

PART NUMBER	SIZE	QTY/BX	LIST PRICE
JPR22006	2/56 X 3/16	100	
JPR22012	2/56 X 3/8	100	
JPR33006	3/48 X 3/16	100	
JPR33008	3/48 X 1/4	100	
JPR33012	3/48 X 3/8	100	
JPR33016	3/48 X 1/2	100	
JPR44004	4/40 X 1/8	100	
JPR44006	4/40 X 3/16	100	
JPR44008	4/40 X 1/4	100	
JPR44012	4/40 x 3/8	100	
JPR44016	4/40 X 1/2	100	
JPR44020	4/40 X 5/8	100	
JPR44024	4/40 x 3/4	100	
JPRS44008	4/48 X 1/4	100	
JPRS44012	4/48 X 3/8	100	
JPRS44016	4/48 X 1/2	100	
JPRS44020	4/48 X 5/8	100	
JPRS44024	4/48 X 3/4	100	
JPRS44032	4/48 X 1	100	
JPR55008	5/40 x 1/4	100	
JPR55012	5/40 X 3/8	100	
JPR55016	5/40 X 1/2	100	
JPR55020	5/40 X 5/8	100	
JPR55024	5/40 X 3/4	100	
JPR66008	6/32 X 1/4	100	
JPR66012	6/32 X 3/8	100	
JPR66016	6/32 X 1/2	100	
JPR66020	6/32 X 5/8	100	
JPR66024	6/32 X 3/4	100	
JPR66032	6/32 X 1	100	
JPR66040	6/32 X 1 1/4	100	
JPRS66008	6/40 X 1/4	100	
JPRS66012	6/40 X 3/8	100	
JPRS66016	6/40 X 1/2	100	
JPRS66020	6/40 X 5/8	100	
JPRS66024	6/40 X 3/4	100	
JPRS66032	6/40 X 1	100	
JPR88012	8/32 X 3/8	100	
JPR88016	8/32 X 1/2	100	
JPR88020	8/32 X 5/8	100	
JPR88024	8/32 X 3/4	100	
JPR88032	8/32 X 1	100	
JPR88040	8/32 X 1 1/4	100	
JPRS88008	8/36 X 1/4	100	
JPRS88012	8/36 X 3/8	100	
JPRS88016	8/36 X 1/2	100	

(continued...)

# FLAT SOCKET CAP SCREW (cont.)

PLAIN FINISH- GLOBAL

Line: 286-07

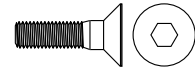

PART NUMBER	SIZE	QTY/BX	LIST PRICE
JPRS88020	8/36 X 5/8	100	
JPRS88024	8/36 X 3/4	100	
JPRS88032	8/36 X 1	100	
JPR03012	10/24 X 3/8	100	
JPR03016	10/24 X 1/2	100	
JPR03020	10/24 X 5/8	100	
JPR03024	10/24 X 3/4	100	
JPR03028	10/24 X 7/8	100	
JPR03032	10/24 X 1	100	
JPR03040	10/24 X 1 1/4	100	
JPR03048	10/24 X 1 1/2	100	
JPR03056	10/24 X 1 3/4	100	
JPR03064	10/24 X 2	100	
JPR03080	10/24 X 2 1/2	100	
JPRS03008	10/32 X 1/4	100	
JPRS03012	10/32 X 3/8	100	
JPRS03016	10/32 X 1/2	100	
JPRS03020	10/32 X 5/8	100	
JPRS03024	10/32 X 3/4	100	
JPRS03028	10/32 X 7/8	100	
JPRS03032	10/32 X 1	100	
JPRS03040	10/32 X 1 1/4	100	
JPRS03048	10/32 X 1 1/2	100	
JPRS03056	10/32 X 1 3/4	100	
JPRS03064	10/32 X 2	100	
JPR21012	12/24 X 3/8	100	
JPR21016	12/24 X 1/2	100	
JPR04008	1/4-20 X 1/4	100	
JPR04012	1/4-20 X 3/8	100	
JPR04016	1/4-20 X 1/2	100	
JPR04020	1/4-20 X 5/8	100	
JPR04024	1/4-20 X 3/4	100	
JPR04032	1/4-20 X 1	100	
JPR04040	1/4-20 X 1 1/4	100	
JPR04048	1/4-20 X 1 1/2	100	
JPR04056	1/4-20 X 1 3/4	100	
JPR04064	1/4-20 X 2	100	
JPR04088	1/4-20 X 2 3/4	50	
JPRS04012	1/4-28 X 3/8	100	
JPRS04016X	1/4-28 X 1/2	100	
JPRS04020	1/4-28 X 5/8	100	
JPRS04024X	1/4-28 X 3/4	100	
JPRS04032X	1/4-28 X 1	100	
JPRS04040	1/4-28 X 1 1/4	100	
JPRS04048	1/4-28 X 1 1/2	100	
JPRS04064	1/4-28 X 2	100	

(continued...)

**FLAT SOCKET CAP SCREW (cont.)**

PLAIN FINISH- GLOBAL

Line: 286-07

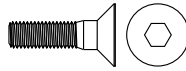

PART NUMBER	SIZE	QTY/BX	LIST PRICE
JPR05016	5/16-18 X 1/2	100	
JPR05020	5/16-18 X 5/8	100	
JPR05024	5/16-18 X 3/4	100	
JPR05028	5/16-18 X 7/8	100	
JPR05032	5/16-18 X 1	100	
JPR05040	5/16-18 X 1 1/4	100	
JPR05048	5/16-18 X 1 1/2	100	
JPR05056	5/16-18 X 1 3/4	100	
JPR05064	5/16-18 X 2	100	
JPR05072	5/16-18 X 2 1/4	100	
JPR05080	5/16-18 X 2 1/2	100	
JPR05088	5/16-18 X 2 3/4	100	
JPR05096	5/16-18 X 3	100	
JPR05112	5/16-18 X 3 1/2	50	
JPRS05012	5/16-24 X 3/8	100	
JPRS05016	5/16-24 X 1/2	100	
JPRS05020	5/16-24 X 5/8	100	
JPRS05024	5/16-24 X 3/4	100	
JPRS05032	5/16-24 X 1	100	
JPRS05040	5/16-24 X 1 1/4	100	
JPRS05048	5/16-24 X 1 1/2	100	
JPRS05064	5/16-24 X 2	100	
JPRS05072	5/16-24 X 2 1/4	100	
JPRS05080	5/16-24 X 2 1/2	100	
JPRS05096	5/16-24 X 3	100	
JPR06016	3/8-16 X 1/2	100	
JPR06020	3/8-16 X 5/8	100	
JPR06024	3/8-16 X 3/4	100	
JPR06032	3/8-16 X 1	100	
JPR06040	3/8-16 X 1 1/4	100	
JPR06048	3/8-16 X 1 1/2	100	
JPR06056	3/8-16 X 1 3/4	50	
JPR06064	3/8-16 X 2	50	
JPR06072	3/8-16 X 2 1/4	50	
JPR06080	3/8-16 X 2 1/2	50	
JPR06088	3/8-16 X 2 3/4	50	
JPR06096	3/8-16 X 3	50	
JPR06112	3/8-16 X 3 1/2	50	
JPR06128	3/8-16 X 4	50	
JPR06192	3/8-16 X 6	25	
JPRS06020	3/8-24 X 5/8	100	
JPRS06024	3/8-24 X 3/4	100	
JPRS06032X	3/8-24 X 1	100	
JPRS06040	3/8-24 X 1 1/4	100	
JPRS06048	3/8-24 X 1 1/2	100	
JPRS06056	3/8-24 X 1 3/4	50	

(continued...)

**FLAT SOCKET CAP SCREW (cont.)**

PLAIN FINISH- GLOBAL

Line: 286-07

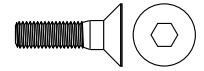

PART NUMBER	SIZE	QTY/BX	LIST PRICE
JPRS06064	3/8-24 X 2	50	
JPR07024	7/16-14 X 3/4	50	
JPR07032	7/16-14 X 1	50	
JPR07040	7/16-14 X 1 1/4	50	
JPR07048	7/16-14 X 1 1/2	50	
JPR07056	7/16-14 X 1 3/4	50	
JPR07064	7/16-14 X 2	50	
JPRS07040	7/16-20 X 1 1/4	50	
JPR08024	1/2-13 X 3/4	50	
JPR08032	1/2-13 X 1	50	
JPR08040	1/2-13 X 1 1/4	50	
JPR08048	1/2-13 X 1 1/2	50	
JPR08056	1/2-13 X 1 3/4	50	
JPR08064	1/2-13 X 2	50	
JPR08072	1/2-13 X 2 1/4	50	
JPR08080	1/2-13 X 2 1/2	25	
JPR08088	1/2-13 X 2 3/4	25	
JPR08096	1/2-13 X 3	25	
JPR08112	1/2-13 X 3 1/2	25	
JPR08128	1/2-13 X 4	25	
JPR08256	1/2-13 X 8	25	
JPRS08024	1/2-20 X 3/4	50	
JPRS08032	1/2-20 X 1	50	
JPRS08040	1/2-20 X 1 1/4	50	
JPRS08048	1/2-20 X 1 1/2	50	
JPRS08056	1/2-20 X 1 3/4	50	
JPRS08064	1/2-20 X 2	50	
JPRS08112	1/2-20 X 3 1/2	25	
JPR10032	5/8-11 X 1	25	
JPR10040	5/8-11 X 1 1/4	25	
JPR10048	5/8-11 X 1 1/2	25	
JPR10056	5/8-11 X 1 3/4	25	
JPR10064	5/8-11 X 2	25	
JPR10072	5/8-11 X 2 1/4	25	
JPR10080	5/8-11 X 2 1/2	25	
JPR10088X	5/8-11 X 2 3/4	10	
JPR10096	5/8-11 X 3	10	
JPR10112X	5/8-11 X 3 1/2	10	
JPR10128X	5/8-11 X 4	10	
JPR10144X	5/8-11 X 4 1/2	10	
JPR10160X	5/8-11 X 5	10	
JPRS10040	5/8-18 X 1 1/4	25	
JPRS10064	5/8-18 X 2	25	
JPR12040	3/4-10 X 1 1/4	25	
JPR12048	3/4-10 X 1 1/2	25	
JPR12056	3/4-10 X 1 3/4	25	

(continued...)

## FLAT SOCKET CAP SCREW (cont.)

PLAIN FINISH- GLOBAL

Line: 286-07

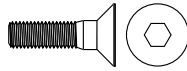

PART NUMBER	SIZE	QTY/BX	LIST PRICE
JPR12064	3/4-10 X 2	25	
JPR12072	3/4-10 X 2 1/4	25	
JPR12080	3/4-10 X 2 1/2	25	
JPR12096	3/4-10 X 3	25	
JPR12104	3/4-10 X 3 1/4	10	
JPR12112X	3/4-10 X 3 1/2	10	
JPR12128X	3/4-10 X 4	10	
JPR12144X	3/4-10 X 4 1/2	10	
JPR12160X	3/4-10 X 5	10	
JPR12224	3/4-10 X 7	10	
JPRS12040	3/4-16 X 1 1/4	25	
JPR16096	1-8 X 3	10	
JPR16112	1-8 X 3 1/2	10	
JPR16128	1-8 X 4	10	
JPR16160	1-8 X 5	10	
JPR16192	1-8 X 6	10	

## BUTTON SOCKET CAP SCREW (cont.)

PLAIN FINISH- GLOBAL

Line: 286-08

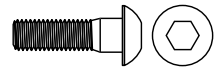

PART NUMBER	SIZE	QTY/BX	LIST PRICE
ABS566020	6/40 X 5/8	100	
ABS566024	6/40 X 3/4	100	
ABS566032	6/40 X 1	100	
ABS88008	8/32 X 1/4	100	
ABS88012	8/32 X 3/8	100	
ABS88016	8/32 X 1/2	100	
ABS88020	8/32 X 5/8	100	
ABS88024	8/32 X 3/4	100	
ABS88028	8/32 X 7/8	100	
ABS88032	8/32 X 1	100	
ABS88008	8/36 X 1/4	100	
ABS88012	8/36 X 3/8	100	
ABS88016	8/36 X 1/2	100	
ABS88020	8/36 X 5/8	100	
ABS88024	8/36 X 3/4	100	
ABS88032	8/36 X 1	100	
ABS03008	10/24 X 1/4	100	
ABS03012	10/24 X 3/8	100	
ABS03016	10/24 X 1/2	100	
ABS03020	10/24 X 5/8	100	
ABS03024	10/24 X 3/4	100	
ABS03028	10/24 X 7/8	100	
ABS03032	10/24 X 1	100	
ABS03040	10/24 X 1 1/4	100	
ABS03008	10/32 X 1/4	100	
ABS03012	10/32 X 3/8	100	
ABS03016	10/32 X 1/2	100	
ABS03020	10/32 X 5/8	100	
ABS03024	10/32 X 3/4	100	
ABS03028	10/32 X 7/8	100	
ABS03032	10/32 X 1	100	
ABS04012	1/4-20 X 3/8	100	
ABS04014	1/4-20 X 7/16	100	
ABS04016	1/4-20 X 1/2	100	
ABS04020	1/4-20 X 5/8	100	
ABS04024	1/4-20 X 3/4	100	
ABS04028	1/4-20 X 7/8	100	
ABS04032	1/4-20 X 1	100	
ABS04040	1/4-20 X 1 1/4	100	
ABS04048	1/4-20 X 1 1/2	100	
ABS04012	1/4-28 X 3/8	100	
ABS04016	1/4-28 X 1/2	100	
ABS04020	1/4-28 X 5/8	100	
ABS04024	1/4-28 X 3/4	100	
ABS04032	1/4-28 X 1	100	
ABS04048	1/4-28 X 1 1/2	100	

## BUTTON SOCKET CAP SCREW

PLAIN FINISH- GLOBAL

Line: 286-08

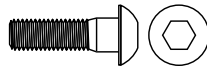

PART NUMBER	SIZE	QTY/BX	LIST PRICE
ABS22006	2/56 X 3/16	100	
ABS22016	2/56 X 1/2	100	
ABS22024	2/56 X 3/4	100	
ABS22032	2/56 X 1	100	
ABS33008	3/48 X 1/4	100	
ABS33012	3/48 X 3/8	100	
ABS44008	4/40 X 1/4	100	
ABS44012	4/40 X 3/8	100	
ABS44016	4/40 X 1/2	100	
ABS44008	4/48 X 1/4	100	
ABS44012	4/48 X 3/8	100	
ABS44016	4/48 X 1/2	100	
ABS44020	4/48 X 5/8	100	
ABS44024	4/48 X 3/4	100	
ABS44032	4/48 X 1	100	
ABS66008	6/32 X 1/4	100	
ABS66012	6/32 X 3/8	100	
ABS66016	6/32 X 1/2	100	
ABS66020	6/32 X 5/8	100	
ABS66024	6/32 X 3/4	100	
ABS66040	6/32 X 1 1/4	100	
ABS66048	6/32 X 1 1/2	100	
ABS66008	6/40 X 1/4	100	
ABS66012	6/40 X 3/8	100	
ABS66016	6/40 X 1/2	100	

(continued...)

(continued...)



## BUTTON SOCKET CAP SCREW (cont.)

PLAIN FINISH- GLOBAL

Line: 286-08

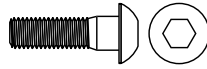

PART NUMBER	SIZE	QTY/BX	LIST PRICE
ABSS04072	1/4-28 X 2 1/4	100	
ABS05012	5/16-18 X 3/8	100	
ABS05016	5/16-18 X 1/2	100	
ABS05020	5/16-18 X 5/8	100	
ABS05024	5/16-18 X 3/4	100	
ABS05028	5/16-18 X 7/8	100	
ABS05032	5/16-18 X 1	100	
ABS05048	5/16-18 X 1 1/2	100	
ABSS05012	5/16-24 X 3/8	100	
ABSS05016	5/16-24 X 1/2	100	
ABSS05020	5/16-24 X 5/8	100	
ABSS05024	5/16-24 X 3/4	100	
ABSS05032	5/16-24 X 1	100	
ABSS05040	5/16-24 X 1 1/4	100	
ABSS05064	5/16-24 X 2	100	
ABS06012	3/8-16 X 3/8	100	
ABS06016	3/8-16 X 1/2	100	
ABS06020	3/8-16 X 5/8	100	
ABS06024	3/8-16 X 3/4	100	
ABS06028	3/8-16 X 7/8	100	
ABS06032	3/8-16 X 1	100	
ABS06040	3/8-16 X 1 1/4	100	
ABS06048	3/8-16 X 1 1/2	50	
ABS06056	3/8-16 X 1 3/4	50	
ABS06064	3/8-16 X 2	50	
ABS06096	3/8-16 X 3	25	
ABS06112	3/8-16 X 3 1/2	25	
ABSS06016	3/8-24 X 1/2	100	
ABSS06020	3/8-24 X 5/8	100	
ABSS06032	3/8-24 X 1	100	
ABSS06040	3/8-24 X 1 1/4	100	
ABSS06048	3/8-24 X 1 1/2	100	
ABS08024	1/2-13 X 3/4	100	
ABS08028	1/2-13 X 7/8	50	
ABS08032	1/2-13 X 1	50	
ABS08040	1/2-13 X 1 1/4	50	
ABS08048	1/2-13 X 1 1/2	50	
ABS08064	1/2-13 X 2	50	
ABS08080	1/2-13 X 2 1/2	25	
ABSS08040	1/2-20 X 1 1/4	50	
ABS10032	5/8-11 X 1	25	
ABS10040	5/8-11 X 1 1/4	25	
ABS10048	5/8-11 X 1 1/2	25	
ABS10064	5/8-11 X 2	25	
ABS10072	5/8-11 X 2 1/4	25	

## SOCKET SHOULDER SCREW

PLAIN FINISH- GLOBAL

Line: 286-09

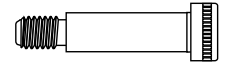

PART NUMBER	SIZE	QTY/BX	LIST PRICE
CFM04012	1/4 x 3/8 (#10-24 THREAD)	25	
CFM04016	1/4 x 1/2 (#10-24 THREAD)	25	
CFM04020	1/4 x 5/8 (#10-24 THREAD)	25	
CFM04024	1/4 x 3/4 (#10-24 THREAD)	25	
CFM04032	1/4 x 1 (#10-24 THREAD)	25	
CFM04040	1/4 x 1 1/4 (#10-24 THREAD)	25	
CFM04048	1/4 x 1 1/2 (#10-24 THREAD)	25	
CFM04056	1/4 x 1 3/4 (#10-24 THREAD)	25	
CFM04064	1/4 x 2 (#10-24 THREAD)	25	
CFM04072	1/4X2 1/4 (#10-24 THREAD)	25	
CFM04080	1/4X2 1/2 (#10-24 THREAD)	25	
CFM05012	5/16 x 3/8 (1/4-20 THREAD)	25	
CFM05016	5/16X1/2 (1/4-20 THREAD)	25	
CFM05020	5/16X5/8 (1/4-20 THREAD)	25	
CFM05024	5/16X3/4 (1/4-20 THREAD)	25	
CFM05032	5/16X1 (1/4-20 THREAD)	25	
CFM05040	5/16X1 1/4 (1/4-20 THREAD)	25	
CFM05048	5/16X1 1/2 (1/4-20 THREAD)	25	
CFM05056	5/16X1 3/4 (1/4-20 THREAD)	25	
CFM05064	5/16X2 (1/4-20 THREAD)	25	
CFM05072	5/16X2 1/4 (1/4-20 THREAD)	25	
CFM05096	5/16X3 (1/4-20 THREAD)	25	
CFM06012	3/8X3/8 (5/16-18 THREAD)	25	
CFM06016	3/8X1/2 (5/16-18 THREAD)	25	
CFM06020	3/8X5/8 (5/16-18 THREAD)	25	
CFM06024	3/8X3/4 (5/16-18 THREAD)	25	
CFM06032	3/8X1 (5/16-18 THREAD)	25	
CFM06040	3/8X1 1/4 (5/16-18 THREAD)	25	
CFM06048	3/8X1 1/2 (5/16-18 THREAD)	25	
CFM06056	3/8X1 3/4 (5/16-18 THREAD)	25	
CFM06064	3/8X2 (5/16-18 THREAD)	25	
CFM06072	3/8X2 1/4 (5/16-18 THREAD)	25	
CFM06080	3/8X2 1/2 (5/16-18 THREAD)	25	
CFM06088	3/8X2 3/4 (5/16-18 THREAD)	25	
CFM06096	3/8X3 (5/16-18 THREAD)	25	
CFM06104	3/8X3 1/4 (5/16-18 THREAD)	25	
CFM06112	3/8X3 1/2 (5/16-18 THREAD)	25	
CFM06120	3/8X3 3/4 (5/16-18 THREAD)	25	
CFM06128	3/8X4 (5/16-18 THREAD)	25	
CFM06144	3/8X4 1/2 (5/16-18 THREAD)	25	
CFM08012	1/2 x 3/8 (3/8-16 THREAD)	25	
CFM08016	1/2 x 1/2 (3/8-16 THREAD)	25	
CFM08020	1/2 x 5/8 (3/8-16 THREAD)	25	
CFM08024	1/2 x 3/4 (3/8-16 THREAD)	25	
CFM08032	1/2 x 1 (3/8-16 THREAD)	25	
CFM08040	1/2X1 1/4 (3/8-16 THREAD)	25	

(continued...)

**SOCKET SHOULDER SCREW (cont.)**

PLAIN FINISH- GLOBAL

Line: 286-09

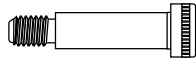

PART NUMBER	SIZE	QTY/BX	LIST PRICE
CFM08048	1/2X1 1/2 (3/8-16 THREAD)	25	
CFM08056	1/2X1 3/4 (3/8-16 THREAD)	25	
CFM08064	1/2 x 2 (3/8-16 THREAD)	25	
CFM08072	1/2X2 1/4 (3/8-16 THREAD)	25	
CFM08080	1/2X2 1/2 (3/8-16 THREAD)	25	
CFM08088	1/2X2 3/4 (3/8-16 THREAD)	25	
CFM08096	1/2 x 3 (3/8-16 THREAD)	25	
CFM08104	1/2X3 1/4 (3/8-16 THREAD)	25	
CFM08112	1/2X3 1/2 (3/8-16 THREAD)	25	
CFM08120	1/2X3 3/4 (3/8-16 THREAD)	25	
CFM08128	1/2 x 4 (3/8-16 THREAD)	25	
CFM08136	1/2X4 1/4 (3/8-16 THREAD)	10	
CFM08144	1/2X4 1/2 (3/8-16 THREAD)	10	
CFM08152	1/2X4 3/4 (3/8-16 THREAD)	10	
CFM08160	1/2 x 5 (3/8-16 THREAD)	10	
CFM10016	5/8 x 1/2 (1/2-13 THREAD)	25	
CFM10020	5/8 x 5/8 (1/2-13 THREAD)	25	
CFM10024	5/8 x 3/4 (1/2-13 THREAD)	25	
CFM10032	5/8 x 1 (1/2-13 THREAD)	25	
CFM10040	5/8X1 1/4 (1/2-13 THREAD)	25	
CFM10048	5/8X1 1/2 (1/2-13 THREAD)	25	
CFM10056	5/8X1 3/4 (1/2-13 THREAD)	25	
CFM10064	5/8 x 2 (1/2-13 THREAD)	25	
CFM10072	5/8X2 1/4 (1/2-13 THREAD)	25	
CFM10080	5/8X2 1/2 (1/2-13 THREAD)	25	
CFM10088	5/8X2 3/4 (1/2-13 THREAD)	25	
CFM10096	5/8 x 3 (1/2-13 THREAD)	25	
CFM10104	5/8X3 1/4 (1/2-13 THREAD)	25	
CFM10112	5/8X3 1/2 (1/2-13 THREAD)	25	
CFM10120	5/8X3 3/4 (1/2-13 THREAD)	25	
CFM10128	5/8 x 4 (1/2-13 THREAD)	10	
CFM10136	5/8X4 1/4 (1/2-13 THREAD)	10	
CFM10144	5/8X4 1/2 (1/2-13 THREAD)	10	
CFM10152	5/8X4 3/4 (1/2-13 THREAD)	10	
CFM10160	5/8 x 5 (1/2-13 THREAD)	10	
CFM10176	5/8X5 1/2 (1/2-13 THREAD)	10	
CFM10192	5/8 x 6 (1/2-13 THREAD)	10	
CFM12024	3/4 x 3/4 (5/8-11 THREAD)	25	
CFM12032	3/4 x 1 (5/8-11 THREAD)	25	
CFM12040	3/4X1 1/4 (5/8-11 THREAD)	25	
CFM12048	3/4X1 1/2 (5/8-11 THREAD)	25	
CFM12056	3/4X1 3/4 (5/8-11 THREAD)	25	
CFM12064	3/4 x 2 (5/8-11 THREAD)	25	
CFM12072	3/4X2 1/4 (5/8-11 THREAD)	25	
CFM12080	3/4X2 1/2 (5/8-11 THREAD)	25	
CFM12088	3/4X2 3/4 (5/8-11 THREAD)	10	

*(continued...)***SOCKET SHOULDER SCREW (cont.)**

PLAIN FINISH- GLOBAL

Line: 286-09

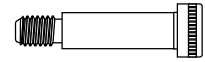

PART NUMBER	SIZE	QTY/BX	LIST PRICE
CFM12096	3/4 x 3 (5/8-11 THREAD)	10	
CFM12104	3/4X3 1/4 (5/8-11 THREAD)	10	
CFM12112	3/4X3 1/2 (5/8-11 THREAD)	10	
CFM12120	3/4X3 3/4 (5/8-11 THREAD)	10	
CFM12128	3/4 x 4 (5/8-11 THREAD)	10	
CFM12136	3/4X4 1/4 (5/8-11 THREAD)	10	
CFM12144	3/4X4 1/2 (5/8-11 THREAD)	10	
CFM12160	3/4 x 5 (5/8-11 THREAD)	10	
CFM12176	3/4X5 1/2 (5/8-11 THREAD)	10	
CFM12192	3/4 x 6 (5/8-11 THREAD)	10	

**CALL - 1 (800) 723-2826**

# SECTION 7 PRODUCT INDEX



Line Description	Alpha	Line#	Page#
COTTER PINS - EXTENDED PRONG - ZINC	LAA	289-00	7-2
COTTER PINS - HAMMER LOCK	JXG	289-01	7-4
DOWEL PINS - ALLOY STEEL - .0002 O/S - DOMESTIC	KRA	291-00	7-5
STANDARD DOWEL PINS ALLOY .0002 O/S	BEL	291-01	7-6
STANDARD PULL DOWEL PINS - ALLOY	ABR	292-01	7-8
SPLIT TENSION PINS - PLAIN	KTA	293-00	7-8
METRIC SPLIT TENSION PINS - PLAIN	BTL	293-01	7-11
SPLIT TENSION PINS - ZINC	KUA	295-00	7-11
SPIRAL SPRING PINS - PLAIN	JWG	295-01	7-14
UNIVERSAL CLEVIS PINS - PLAIN	KNA	298-00	7-16
CLEVIS PINS - ONE HOLE - PLAIN	KLA	299-00	7-16
CLEVIS PINS - ONE HOLE - ZINC	KMA	300-00	7-18
TAPER PINS - MACHINED - PLAIN	DEC	302-00	7-20
KEY STOCK RECTANGLE - ZINC	DHC	304-00	7-23
KEY STOCK SQUARE HI-CARBON - PLAIN	CAM	304-01	7-23
KEY STOCK SQUARE GRADE 2 - ZINC	DJC	305-00	7-24
KEY STOCK SQUARE - STAINLESS	ARP	305-02	7-24
METRIC KEY STOCK SQUARE - STAINLESS	BSK	305-03	7-24
METRIC KEY STOCK SQUARE - STEEL	BTT	305-04	7-24
WOODRUFF KEYS (HALF MOON) STEEL - PLAIN	DDC	306-00	7-25
EXTERNAL RETAINING SNAP RING #1400	YUB	308-00	7-26
INTERNAL RETAINING SNAP RING #1300	YVB	309-00	7-26
EXTERNAL C RETAINING SNAP RING #1800	YWB	310-00	7-27
EXTERNAL E RETAINING SNAP RING #1500	YXB	311-00	7-27
METRIC EXTERNAL RETAINING RING - DSH SERIES	CFR	311-25	7-28
METRIC INTERNAL RETAINING RING - DHO SERIES	CFS	311-26	7-29
METRIC EXTERNAL E RETAINING RING - DE SERIES	CFT	311-27	7-30
RETAINING RING PLIERS - EXTERNAL	YYB	312-00	7-30
RETAINING RING PLIERS - INTERNAL	YZB	313-00	7-30
RETAINING RING PLIERS - EXTERNAL METRIC	CFX	314-01	7-30
RETAINING RING PLIERS - INTERNAL METRIC	CFY	314-02	7-30
HAIR PIN COTTERS STEEL & STAINLESS	ZRB	315-00	7-30
HAIR PIN COTTERS STEEL (CONTINUED)	ZRB	315-01	7-31
HAIR PIN CLIPS - ZINC	ZSB	316-00	7-31
HITCH PIN STEEL - ZINC	JNF	316-01	7-31
SAFETY SNAPPER PINS - ZINC	JYG	316-02	7-32
LYNCH RING PINS - ZINC	KEA	316-03	7-32

**COTTER PIN EXT PRONG**

ZINC PLATED

Line: 289-00

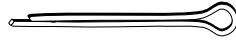

PART NUMBER	SIZE	QTY/BX	LIST PRICE
LAA31016	1/32 X 1/2	500	
LAA31016C	1/32 X 1/2	100	
LAA31024	1/32 X 3/4	500	
LAA31024C	1/32 X 3/4	100	
LAA31032	1/32 X 1	500	
LAA31032C	1/32 X 1	100	
LAA31040	1/32 X 1 1/4	500	
LAA31040C	1/32 X 1 1/4	100	
LAA31048	1/32 X 1 1/2	500	
LAA31048C	1/32 X 1 1/2	100	
LAA46008	3/64 X 1/4	500	
LAA46008C	3/64 X 1/4	100	
LAA46016	3/64 X 1/2	500	
LAA46016C	3/64 X 1/2	100	
LAA46024	3/64 X 3/4	500	
LAA46024C	3/64 X 3/4	100	
LAA46032	3/64 X 1	500	
LAA46032C	3/64 X 1	100	
LAA46040	3/64 X 1 1/4	500	
LAA46040C	3/64 X 1 1/4	100	
LAA46048	3/64 X 1 1/2	500	
LAA46048C	3/64 X 1 1/2	100	
LAA01008C	1/16 X 1/4	100	
LAA01012C	1/16 X 3/8	100	
LAA01016	1/16 X 1/2	500	
LAA01016C	1/16 X 1/2	100	
LAA01024	1/16 X 3/4	500	
LAA01024C	1/16 X 3/4	100	
LAA01032	1/16 X 1	500	
LAA01032C	1/16 X 1	100	
LAA01040	1/16 X 1 1/4	500	
LAA01040C	1/16 X 1 1/4	100	
LAA01048	1/16 X 1 1/2	500	
LAA01048C	1/16 X 1 1/2	100	
LAA01056	1/16 X 1 3/4	500	
LAA01056C	1/16 X 1 3/4	100	
LAA01064	1/16 X 2	500	
LAA01064C	1/16 X 2	100	
LAA01080	1/16 X 2 1/2	250	
LAA01080C	1/16 X 2 1/2	100	
LAA01096	1/16 X 3	250	
LAA01096C	1/16 X 3	100	
LAA78016	5/64 X 1/2	500	
LAA78016C	5/64 X 1/2	100	

(continued...)

**COTTER PIN EXT PRONG (cont.)**

ZINC PLATED

Line: 289-00



PART NUMBER	SIZE	QTY/BX	LIST PRICE
LAA78020	5/64 X 5/8	500	
LAA78020C	5/64 X 5/8	100	
LAA78024	5/64 X 3/4	500	
LAA78024C	5/64 X 3/4	100	
LAA78032	5/64 X 1	500	
LAA78032C	5/64 X 1	100	
LAA78040	5/64 X 1 1/4	500	
LAA78040C	5/64 X 1 1/4	100	
LAA78048	5/64 X 1 1/2	500	
LAA78048C	5/64 X 1 1/2	100	
LAA78056	5/64 X 1 3/4	500	
LAA78056C	5/64 X 1 3/4	100	
LAA78064	5/64 X 2	500	
LAA78064C	5/64 X 2	100	
LAA78080C	5/64 X 2 1/2	100	
LAA93016	3/32 X 1/2	500	
LAA93016C	3/32 X 1/2	100	
LAA93020	3/32 X 5/8	500	
LAA93020C	3/32 X 5/8	100	
LAA93024	3/32 X 3/4	500	
LAA93024C	3/32 X 3/4	100	
LAA93032	3/32 X 1	500	
LAA93032C	3/32 X 1	100	
LAA93040	3/32 X 1 1/4	500	
LAA93040C	3/32 X 1 1/4	100	
LAA93048	3/32 X 1 1/2	500	
LAA93048C	3/32 X 1 1/2	100	
LAA93056	3/32 X 1 3/4	250	
LAA93056C	3/32 X 1 3/4	100	
LAA93064	3/32 X 2	250	
LAA93064C	3/32 X 2	100	
LAA93072	3/32 X 2 1/4	250	
LAA93072C	3/32 X 2 1/4	100	
LAA93080	3/32 X 2 1/2	250	
LAA93080C	3/32 X 2 1/2	100	
LAA93096	3/32 X 3	250	
LAA93096C	3/32 X 3	100	
LAA109016C	7/64 X 1/2	100	
LAA109024	7/64 X 3/4	500	
LAA109024C	7/64 X 3/4	100	
LAA109032	7/64 X 1	500	
LAA109032C	7/64 X 1	100	
LAA109040	7/64 X 1 1/4	500	
LAA109040C	7/64 X 1 1/4	100	

(continued...)

**COTTER PIN EXT PRONG (cont.)**

ZINC PLATED

Line: 289-00



PART NUMBER	SIZE	QTY/BX	LIST PRICE
LAA109048	7/64 X 1 1/2	500	
LAA109048C	7/64 X 1 1/2	100	
LAA109056	7/64 X 1 3/4	500	
LAA109056C	7/64 X 1 3/4	100	
LAA109064	7/64 X 2	250	
LAA109064C	7/64 X 2	100	
LAA109080	7/64 X 2 1/2	250	
LAA109080C	7/64 X 2 1/2	100	
LAA109096	7/64 X 3	250	
LAA109096C	7/64 X 3	100	
LAA02016	1/8 X 1/2	500	
LAA02016C	1/8 X 1/2	100	
LAA02020	1/8 X 5/8	500	
LAA02020C	1/8 X 5/8	100	
LAA02024	1/8 X 3/4	500	
LAA02024C	1/8 X 3/4	100	
LAA02032	1/8 X 1	500	
LAA02032C	1/8 X 1	100	
LAA02040	1/8 X 1 1/4	500	
LAA02040C	1/8 X 1 1/4	100	
LAA02048	1/8 X 1 1/2	500	
LAA02048C	1/8 X 1 1/2	100	
LAA02056	1/8 X 1 3/4	250	
LAA02056C	1/8 X 1 3/4	100	
LAA02064	1/8 X 2	250	
LAA02064C	1/8 X 2	100	
LAA02072	1/8 X 2 1/4	100	
LAA02080	1/8 X 2 1/2	100	
LAA02096	1/8 X 3	100	
LAA02112	1/8 X 3 1/2	100	
LAA02128	1/8 X 4	100	
LAA140024	9/64 X 3/4	250	
LAA140024C	9/64 X 3/4	100	
LAA140032	9/64 X 1	250	
LAA140032C	9/64 X 1	100	
LAA140040	9/64 X 1 1/4	250	
LAA140040C	9/64 X 1 1/4	100	
LAA140048	9/64 X 1 1/2	250	
LAA140048C	9/64 X 1 1/2	100	
LAA140056	9/64 X 1 3/4	250	
LAA140056C	9/64 X 1 3/4	100	
LAA140064	9/64 X 2	250	
LAA140064C	9/64 X 2	100	
LAA140072	9/64 X 2 1/4	250	

(continued...)

**COTTER PIN EXT PRONG (cont.)**

ZINC PLATED

Line: 289-00



PART NUMBER	SIZE	QTY/BX	LIST PRICE
LAA140072C	9/64 X 2 1/4	100	
LAA140080	9/64 X 2 1/2	250	
LAA140080C	9/64 X 2 1/2	100	
LAA140096	9/64 X 3	250	
LAA140096C	9/64 X 3	100	
LAA156024	5/32 X 3/4	250	
LAA156024C	5/32 X 3/4	100	
LAA156032	5/32 X 1	250	
LAA156032C	5/32 X 1	100	
LAA156040	5/32 X 1 1/4	250	
LAA156040C	5/32 X 1 1/4	100	
LAA156048	5/32 X 1 1/2	250	
LAA156048C	5/32 X 1 1/2	100	
LAA156056	5/32 X 1 3/4	250	
LAA156056C	5/32 X 1 3/4	100	
LAA156064	5/32 X 2	250	
LAA156064C	5/32 X 2	100	
LAA156072	5/32 X 2 1/4	100	
LAA156080	5/32 X 2 1/2	100	
LAA156096	5/32 X 3	100	
LAA156112	5/32 X 3 1/2	100	
LAA156128	5/32 X 4	100	
LAA03024	3/16 X 3/4	100	
LAA03032	3/16 X 1	100	
LAA03040	3/16 X 1 1/4	100	
LAA03048	3/16 X 1 1/2	100	
LAA03056	3/16 X 1 3/4	100	
LAA03064	3/16 X 2	100	
LAA03072	3/16 X 2 1/4	100	
LAA03080	3/16 X 2 1/2	100	
LAA03096	3/16 X 3	100	
LAA03112	3/16 X 3 1/2	100	
LAA03128	3/16 X 4	100	
LAA03192	3/16 X 6	100	
LAA21032	7/32 X 1	100	
LAA21040	7/32 X 1 1/4	100	
LAA21048	7/32 X 1 1/2	100	
LAA21056	7/32 X 1 3/4	100	
LAA21064	7/32 X 2	50	
LAA21064C	7/32 X 2	100	
LAA21072	7/32 X 2 1/4	50	
LAA21080	7/32 X 2 1/2	50	
LAA21096	7/32 X 3	50	
LAA21112	7/32 X 3 1/2	50	

(continued...)

**COTTER PIN EXT PRONG** (cont.)

ZINC PLATED

Line: 289-00

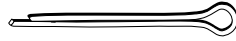

PART NUMBER	SIZE	QTY/BX	LIST PRICE
LAA21112C	7/32 X 3 1/2	100	
LAA21128	7/32 X 4	50	
LAA04032	1/4 X 1	100	
LAA04040	1/4 X 1 1/4	100	
LAA04048	1/4 X 1 1/2	100	
LAA04056	1/4 X 1 3/4	100	
LAA04064	1/4 X 2	100	
LAA04072	1/4 X 2 1/4	50	
LAA04080	1/4 X 2 1/2	50	
LAA04080C	1/4 X 2 1/2	100	
LAA04096	1/4 X 3	50	
LAA04096C	1/4 X 3	100	
LAA04112	1/4 X 3 1/2	50	
LAA04112C	1/4 X 3 1/2	100	
LAA04128	1/4 X 4	50	
LAA04128C	1/4 X 4	100	
LAA04144	1/4 X 4 1/2	50	
LAA04160	1/4 X 5	50	
LAA04192	1/4 X 6	50	
LAA05032	5/16 X 1	50	
LAA05040	5/16 X 1 1/4	50	
LAA05048	5/16 X 1 1/2	50	
LAA05056	5/16 X 1 3/4	50	
LAA05064	5/16 X 2	50	
LAA05072	5/16 X 2 1/4	50	
LAA05080	5/16 X 2 1/2	50	
LAA05096	5/16 X 3	50	
LAA05096C	5/16 X 3	100	
LAA05112	5/16 X 3 1/2	50	
LAA05112C	5/16 X 3 1/2	100	
LAA05128	5/16 X 4	50	
LAA05128C	5/16 X 4	100	
LAA05160	5/16 X 5	25	
LAA05160C	5/16 X 5	100	
LAA05192	5/16 X 6	25	
LAA06040	3/8 X 1 1/4	50	
LAA06048	3/8 X 1 1/2	50	
LAA06056	3/8 X 1 3/4	50	
LAA06064	3/8 X 2	50	
LAA06072	3/8 X 2 1/4	50	
LAA06080	3/8 X 2 1/2	50	
LAA06096	3/8 X 3	50	
LAA06112	3/8 X 3 1/2	50	
LAA06128	3/8 X 4	50	

(continued...)

**COTTER PIN EXT PRONG** (cont.)

ZINC PLATED

Line: 289-00

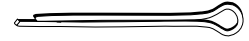

PART NUMBER	SIZE	QTY/BX	LIST PRICE
LAA06160	3/8 X 5	25	
LAA06192	3/8 X 6	25	
LAA07064	7/16 X 2	25	
LAA07080	7/16 X 2 1/2	25	
LAA07096	7/16 X 3	25	
LAA07112	7/16 X 3 1/2	25	
LAA07128	7/16 X 4	25	
LAA07160	7/16 X 5	25	
LAA07192	7/16 X 6	25	
LAA08064	1/2 X 2	25	
LAA08072	1/2 X 2 1/4	25	
LAA08080	1/2 X 2 1/2	25	
LAA08096	1/2 X 3	25	
LAA08112	1/2 X 3 1/2	25	
LAA08128	1/2 X 4	25	
LAA08160	1/2 X 5	25	
LAA08192	1/2 X 6	25	
LAA10096	5/8 X 3	25	
LAA10112	5/8 X 3 1/2	25	
LAA10128	5/8 X 4	25	
LAA10160	5/8 X 5	25	
LAA10192	5/8 X 6	25	

**HAMMERLOCK COTTER PIN**

ZINC PLATED

Line: 289-01

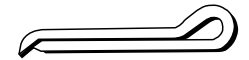

PART NUMBER	SIZE	QTY/BX	LIST PRICE
JXG01024	1/16 X 3/4	500	
JXG01032	1/16 X 1	500	
JXG02048	1/8 X 1 1/2	250	
JXG02064	1/8 X 2	250	
JXG156048X	5/32 X 1 1/2	250	
JXG156064	5/32 X 2	250	
JXG156080X	5/32 X 2 1/2	250	
JXG05048	5/16 X 1 1/2	100	

# ALLOY DOWEL PINS DOMESTIC .0002 O/S

STEEL FINISH

Line: 291-00

PART NUMBER	SIZE	QTY/BX	LIST PRICE
KRA01006X	1/16 X 3/16	100	
KRA01008X	1/16 X 1/4	40	
KRA01012	1/16 X 3/8	100	
KRA01016	1/16 X 1/2	100	
KRA01020	1/16 X 5/8	100	
KRA01024	1/16 X 3/4	100	
KRA01028X	1/16 X 7/8	40	
KRA01032	1/16 X 1	40	
KRA93006X	3/32 X 3/16	100	
KRA93008X	3/32 X 1/4	100	
KRA93010	3/32 X 5/16	40	
KRA93012	3/32 X 3/8	100	
KRA93014X	3/32 X 7/16	40	
KRA93016	3/32 X 1/2	100	
KRA93020	3/32 X 5/8	100	
KRA93024	3/32 X 3/4	100	
KRA93028X	3/32 X 7/8	40	
KRA93032	3/32 X 1	100	
KRA02012	1/8 X 3/8	100	
KRA02016	1/8 X 1/2	100	
KRA02020	1/8 X 5/8	100	
KRA02024	1/8 X 3/4	40	
KRA02028	1/8 X 7/8	100	
KRA02032	1/8 X 1	40	
KRA02036X	1/8 X 1 1/8	40	
KRA02040	1/8 X 1 1/4	100	
KRA02044X	1/8 X 1 3/8	40	
KRA02048	1/8 X 1 1/2	100	
KRA02056	1/8 X 1 3/4	100	
KRA02064	1/8 X 2	100	
KRA03016	3/16 X 1/2	100	
KRA03020	3/16 X 5/8	100	
KRA03024	3/16 X 3/4	100	
KRA03028	3/16 X 7/8	100	
KRA03032	3/16 X 1	40	
KRA03036X	3/16 X 1 1/8	40	
KRA03040	3/16 X 1 1/4	100	
KRA03048	3/16 X 1 1/2	100	
KRA03056	3/16 X 1 3/4	40	
KRA03064	3/16 X 2	40	
KRA03080X	3/16 X 2 1/2	40	
KRA04016	1/4 X 1/2	100	
KRA04020	1/4 X 5/8	40	
KRA04024	1/4 X 3/4	100	

(continued...)

# ALLOY DOWEL PINS DOMESTIC .0002 O/S (cont.)

STEEL FINISH

Line: 291-00

PART NUMBER	SIZE	QTY/BX	LIST PRICE
KRA04028	1/4 X 7/8	40	
KRA04032	1/4 X 1	40	
KRA04040	1/4 X 1 1/4	100	
KRA04044X	1/4 X 1 3/8	40	
KRA04048	1/4 X 1 1/2	100	
KRA04056	1/4 X 1 3/4	100	
KRA04064	1/4 X 2	40	
KRA04072	1/4 X 2 1/4	40	
KRA04080	1/4 X 2 1/2	100	
KRA05016	5/16 X 1/2	40	
KRA05020	5/16 X 5/8	100	
KRA05024	5/16 X 3/4	100	
KRA05028	5/16 X 7/8	40	
KRA05032	5/16 X 1	100	
KRA05036X	5/16 X 1 1/8	40	
KRA05040	5/16 X 1 1/4	100	
KRA05044X	5/16 X 1 3/8	100	
KRA05048	5/16 X 1 1/2	40	
KRA05056	5/16 X 1 3/4	100	
KRA05064	5/16 X 2	40	
KRA05072	5/16 X 2 1/4	40	
KRA05080	5/16 X 2 1/2	100	
KRA05096	5/16 X 3	40	
KRA05112X	5/16 X 3 1/2	40	
KRA06016	3/8 X 1/2	20	
KRA06020	3/8 X 5/8	20	
KRA06024	3/8 X 3/4	20	
KRA06028	3/8 X 7/8	20	
KRA06032	3/8 X 1	20	
KRA06040	3/8 X 1 1/4	20	
KRA06044X	3/8 X 1 3/8	20	
KRA06048	3/8 X 1 1/2	40	
KRA06056	3/8 X 1 3/4	20	
KRA06064	3/8 X 2	40	
KRA06072	3/8 X 2 1/4	20	
KRA06080	3/8 X 2 1/2	20	
KRA06096	3/8 X 3	40	
KRA07032	7/16 X 1	20	
KRA07040	7/16 X 1 1/4	20	
KRA07048	7/16 X 1 1/2	20	
KRA07056	7/16 X 1 3/4	20	
KRA07064	7/16 X 2	20	
KRA07072X	7/16 X 2 1/4	20	
KRA07080	7/16 X 2 1/2	20	

(continued...)

**ALLOY DOWEL PINS DOMESTIC .0002 O/S** (cont.)

STEEL FINISH

Line: 291-00



PART NUMBER	SIZE	QTY/BX	LIST PRICE
KRA07088X	7/16 X 2 3/4	20	
KRA07096	7/16 X 3	20	
KRA08024	1/2 X 3/4	20	
KRA08032	1/2 X 1	20	
KRA08040	1/2 X 1 1/4	20	
KRA08048	1/2 X 1 1/2	20	
KRA08056	1/2 X 1 3/4	20	
KRA08064	1/2 X 2	20	
KRA08072	1/2 X 2 1/4	20	
KRA08080	1/2 X 2 1/2	20	
KRA08088X	1/2 X 2 3/4	20	
KRA08096	1/2 X 3	20	
KRA08112	1/2 X 3 1/2	20	
KRA08128	1/2 X 4	20	
KRA10032	5/8 X 1	10	
KRA10040	5/8 X 1 1/4	10	
KRA10048	5/8 X 1 1/2	10	
KRA10056	5/8 X 1 3/4	10	
KRA10064	5/8 X 2	10	
KRA10072	5/8 X 2 1/4	10	
KRA10080	5/8 X 2 1/2	10	
KRA10096	5/8 X 3	10	
KRA10104X	5/8 X 3 1/4	10	
KRA10112	5/8 X 3 1/2	10	
KRA10128	5/8 X 4	10	
KRA10144	5/8 X 4 1/2	10	
KRA10160	5/8 X 5	10	
KRA12040X	3/4 X 1 1/4	10	
KRA12048X	3/4 X 1 1/2	10	
KRA12064	3/4 X 2	10	
KRA12080	3/4 X 2 1/2	10	
KRA12096	3/4 X 3	10	
KRA12112	3/4 X 3 1/2	10	
KRA12128	3/4 X 4	10	
KRA12144X	3/4 X 4 1/2	10	
KRA12160	3/4 X 5	10	
KRA12192	3/4 X 6	10	
KRA14064	7/8 X 2	10	
KRA14080	7/8 X 2 1/2	10	
KRA14096X	7/8 X 3	10	
KRA14128	7/8 X 4	10	
KRA14192	7/8 X 6	10	
KRA16064	1 X 2	10	
KRA16080	1 X 2 1/2	10	

(continued...)

**ALLOY DOWEL PINS DOMESTIC .0002 O/S** (cont.)

STEEL FINISH

Line: 291-00

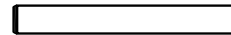

PART NUMBER	SIZE	QTY/BX	LIST PRICE
KRA16096	1 X 3	10	
KRA16112	1 X 3 1/2	10	
KRA16128	1 X 4	10	
KRA16160	1 X 5	10	
KRA16192	1 X 6	10	

**STANDARD DOWEL PIN .0002 O/S**

ALLOY POLISHED FINISH

Line: 291-01



PART NUMBER	SIZE	QTY/BX	LIST PRICE
BEL01008	1/16 X 1/4	100	
BEL01012	1/16 X 3/8	100	
BEL01016	1/16 X 1/2	100	
BEL01020	1/16 X 5/8	100	
BEL01024	1/16 X 3/4	100	
BEL01028	1/16 X 7/8	100	
BEL01032	1/16 X 1	100	
BEL93008	3/32 X 1/4	100	
BEL93010	3/32 X 5/16	100	
BEL93012	3/32 X 3/8	100	
BEL93014	3/32 X 7/16	100	
BEL93016	3/32 X 1/2	100	
BEL93020	3/32 X 5/8	100	
BEL93024	3/32 X 3/4	100	
BEL93032	3/32 X 1	100	
BEL93040	3/32 X 1 1/4	100	
BEL93048	3/32 X 1 1/2	100	
BEL93056	3/32 X 1 3/4	100	
BEL02012	1/8 X 3/8	100	
BEL02016	1/8 X 1/2	100	
BEL02020	1/8 X 5/8	100	
BEL02024	1/8 X 3/4	100	
BEL02028	1/8 X 7/8	100	
BEL02032	1/8 X 1	100	
BEL02040	1/8 X 1 1/4	100	
BEL02048	1/8 X 1 1/2	100	
BEL02056	1/8 X 1 3/4	100	
BEL156016	5/32 X 1/2	100	
BEL156020	5/32 X 5/8	100	
BEL156024	5/32 X 3/4	100	
BEL156032	5/32 X 1	100	
BEL156040	5/32 X 1 1/4	100	
BEL156048	5/32 X 1 1/2	100	
BEL03010	3/16 X 5/16	100	
BEL03016	3/16 X 1/2	100	

(continued...)



**STANDARD DOWEL PIN .0002 O/S (cont.)**

ALLOY POLISHED FINISH

Line: 291-01

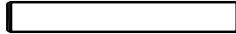

PART NUMBER	SIZE	QTY/BX	LIST PRICE
BEL03020	3/16 X 5/8	100	
BEL03024	3/16 X 3/4	100	
BEL03028	3/16 X 7/8	100	
BEL03032	3/16 X 1	100	
BEL03040	3/16 X 1 1/4	100	
BEL03048	3/16 X 1 1/2	100	
BEL03064	3/16 X 2	100	
BEL04016	1/4 X 1/2	100	
BEL04020	1/4 X 5/8	100	
BEL04024	1/4 X 3/4	100	
BEL04028	1/4 X 7/8	100	
BEL04032	1/4 X 1	100	
BEL04040	1/4 X 1 1/4	100	
BEL04048	1/4 X 1 1/2	100	
BEL04056	1/4 X 1 3/4	50	
BEL04064	1/4 X 2	50	
BEL04072	1/4 X 2 1/4	50	
BEL04080	1/4 X 2 1/2	50	
BEL05016	5/16 X 1/2	100	
BEL05020	5/16 X 5/8	100	
BEL05024	5/16 X 3/4	100	
BEL05028	5/16 X 7/8	100	
BEL05032	5/16 X 1	100	
BEL05040	5/16 X 1 1/4	100	
BEL05048	5/16 X 1 1/2	100	
BEL05056	5/16 X 1 3/4	50	
BEL05064	5/16 X 2	50	
BEL05072	5/16 X 2 1/4	50	
BEL05080	5/16 X 2 1/2	50	
BEL05096	5/16 X 3	50	
BEL06016	3/8 X 1/2	100	
BEL06020	3/8 X 5/8	50	
BEL06024	3/8 X 3/4	50	
BEL06028	3/8 X 7/8	50	
BEL06032	3/8 X 1	50	
BEL06040	3/8 X 1 1/4	50	
BEL06048	3/8 X 1 1/2	50	
BEL06056	3/8 X 1 3/4	50	
BEL06064	3/8 X 2	50	
BEL06080	3/8 X 2 1/2	25	
BEL06096	3/8 X 3	25	
BEL07032	7/16 X 1	50	
BEL07048	7/16 X 1 1/2	50	
BEL07056	7/16 X 1 3/4	50	

(continued...)

**STANDARD DOWEL PIN .0002 O/S (cont.)**

ALLOY POLISHED FINISH

Line: 291-01

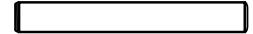

PART NUMBER	SIZE	QTY/BX	LIST PRICE
BEL07064	7/16 X 2	50	
BEL07072	7/16 X 2 1/4	50	
BEL08024	1/2 X 3/4	50	
BEL08032	1/2 X 1	50	
BEL08040	1/2 X 1 1/4	50	
BEL08048	1/2 X 1 1/2	50	
BEL08056	1/2 X 1 3/4	50	
BEL08064	1/2 X 2	50	
BEL08072	1/2 X 2 1/4	25	
BEL08080	1/2 X 2 1/2	25	
BEL08096	1/2 X 3	25	
BEL08112	1/2 X 3 1/2	25	
BEL08128	1/2 X 4	25	
BEL10024	5/8 X 3/4	25	
BEL10032	5/8 X 1	25	
BEL10040	5/8 X 1 1/4	25	
BEL10048	5/8 X 1 1/2	25	
BEL10056	5/8 X 1 3/4	25	
BEL10064	5/8 X 2	25	
BEL10072	5/8 X 2 1/4	25	
BEL10080	5/8 X 2 1/2	25	
BEL10096	5/8 X 3	25	
BEL10112	5/8 X 3 1/2	10	
BEL10128	5/8 X 4	10	
BEL10160	5/8 X 5	10	
BEL12064	3/4 X 2	10	
BEL12096	3/4 X 3	10	
BEL12112	3/4 X 3 1/2	10	
BEL12128	3/4 X 4	10	
BEL12160	3/4 X 5	10	
BEL14064	7/8 X 2	10	
BEL14128	7/8 X 4	10	
BEL14144	7/8 X 4 1/2	10	
BEL14160	7/8 X 5	10	
BEL16064	1 X 2	10	
BEL16128	1 X 4	10	
BEL16144	1 X 4 1/2	10	
BEL16160	1 X 5	10	
BEL16192	1 X 6	10	

# STANDARD PULL DOWEL PIN

ALLOY FINISH

Line: 292-01

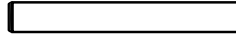

PART NUMBER	SIZE	QTY/BX	LIST PRICE
ABR04024	1/4 X 3/4	40	
ABR04032	1/4 X 1	40	
ABR04040	1/4 X 1 1/4	40	
ABR04048	1/4 X 1 1/2	40	
ABR04064	1/4 X 2	40	
ABR05024	5/16 X 3/4	40	
ABR05032	5/16 X 1	40	
ABR05040	5/16 X 1 1/4	40	
ABR05048	5/16 X 1 1/2	40	
ABR05064	5/16 X 2	40	
ABR06032	3/8 X 1	40	
ABR06040	3/8 X 1 1/4	40	
ABR06048	3/8 X 1 1/2	40	
ABR06056	3/8 X 1 3/4	40	
ABR06064	3/8 X 2	40	
ABR06080	3/8 X 2 1/2	20	
ABR06096	3/8 X 3	20	
ABR08032	1/2 X 1	20	
ABR08040	1/2 X 1 1/4	20	
ABR08048	1/2 X 1 1/2	20	
ABR08056	1/2 X 1 3/4	20	
ABR08064	1/2 X 2	20	
ABR08080	1/2 X 2 1/2	20	
ABR08096	1/2 X 3	20	
ABR10032	5/8 X 1	10	
ABR10048	5/8 X 1 1/2	10	
ABR10064	5/8 X 2	10	
ABR10080	5/8 X 2 1/2	10	
ABR10096	5/8 X 3	10	
ABR10112	5/8 X 3 1/2	10	
ABR10128	5/8 X 4	10	
ABR12064	3/4 X 2	10	
ABR12080	3/4 X 2 1/2	10	
ABR12096	3/4 X 3	10	
ABR16064	1 X 2	10	
ABR16080	1 X 2 1/2	1	
ABR16096	1 X 3	10	
ABR16128	1 X 4	10	

# SPLIT TENSION PINS

PLAIN FINISH

Line: 293-00

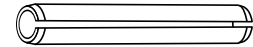

PART NUMBER	SIZE	QTY/BX	LIST PRICE
KTA01004	1/16 X 1/8	100	
KTA01005	1/16 X 5/32	100	
KTA01006	1/16 X 3/16	100	
KTA01008	1/16 X 1/4	100	
KTA01010	1/16 X 5/16	100	
KTA01012	1/16 X 3/8	100	
KTA01014	1/16 X 7/16	100	
KTA01016	1/16 X 1/2	100	
KTA01018	1/16 X 9/16	100	
KTA01020	1/16 X 5/8	100	
KTA01022	1/16 X 11/16	100	
KTA01024	1/16 X 3/4	100	
KTA01026	1/16 X 13/16	100	
KTA01028	1/16 X 7/8	100	
KTA01030	1/16 X 15/16	100	
KTA01032	1/16 X 1	100	
KTA78006	5/64 X 3/16	100	
KTA78008	5/64 X 1/4	100	
KTA78010	5/64 X 5/16	100	
KTA78012	5/64 X 3/8	100	
KTA78014	5/64 X 7/16	100	
KTA78016	5/64 X 1/2	100	
KTA78018	5/64 X 9/16	100	
KTA78020	5/64 X 5/8	100	
KTA78022	5/64 X 11/16	100	
KTA78024	5/64 X 3/4	100	
KTA78026	5/64 X 13/16	100	
KTA78028	5/64 X 7/8	100	
KTA78030	5/64 X 15/16	100	
KTA78032	5/64 X 1	100	
KTA78036	5/64 X 1 1/8	100	
KTA78040	5/64 X 1 1/4	100	
KTA78044	5/64 X 1 3/8	100	
KTA78048	5/64 X 1 1/2	100	
KTA93006	3/32 X 3/16	100	
KTA93008	3/32 X 1/4	100	
KTA93010	3/32 X 5/16	100	
KTA93012	3/32 X 3/8	100	
KTA93014	3/32 X 7/16	100	
KTA93016	3/32 X 1/2	100	
KTA93018	3/32 X 9/16	100	
KTA93020	3/32 X 5/8	100	
KTA93022	3/32 X 11/16	100	
KTA93024	3/32 X 3/4	100	

(continued...)



CALL - 1 (800) 723-2826

**SPLIT TENSION PINS (cont.)**

PLAIN FINISH

Line: 293-00

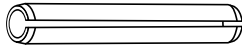

PART NUMBER	SIZE	QTY/BX	LIST PRICE
KTA93026	3/32 X 13/16	100	
KTA93028	3/32 X 7/8	100	
KTA93030	3/32 X 15/16	100	
KTA93032	3/32 X 1	100	
KTA93036	3/32 X 1 1/8	100	
KTA93040	3/32 X 1 1/4	100	
KTA93044	3/32 X 1 3/8	100	
KTA93048	3/32 X 1 1/2	100	
KTA02006	1/8 X 3/16	100	
KTA02008	1/8 X 1/4	100	
KTA02010	1/8 X 5/16	100	
KTA02012	1/8 X 3/8	100	
KTA02014	1/8 X 7/16	100	
KTA02016	1/8 X 1/2	100	
KTA02018	1/8 X 9/16	100	
KTA02020	1/8 X 5/8	100	
KTA02022	1/8 X 11/16	100	
KTA02024	1/8 X 3/4	100	
KTA02026	1/8 X 13/16	100	
KTA02028	1/8 X 7/8	100	
KTA02030	1/8 X 15/16	100	
KTA02032	1/8 X 1	100	
KTA02036	1/8 X 1 1/8	100	
KTA02040	1/8 X 1 1/4	100	
KTA02044	1/8 X 1 3/8	100	
KTA02048	1/8 X 1 1/2	100	
KTA02052	1/8 X 1 5/8	100	
KTA02056	1/8 X 1 3/4	100	
KTA02060	1/8 X 1 7/8	100	
KTA02064	1/8 X 2	100	
KTA02068	1/8 X 2 1/8	100	
KTA02072	1/8 X 2 1/4	100	
KTA02080	1/8 X 2 1/2	100	
KTA156008	5/32 X 1/4	100	
KTA156012	5/32 X 3/8	100	
KTA156014	5/32 X 7/16	100	
KTA156016	5/32 X 1/2	100	
KTA156018	5/32 X 9/16	100	
KTA156020	5/32 X 5/8	100	
KTA156022	5/32 X 11/16	100	
KTA156024	5/32 X 3/4	100	
KTA156026	5/32 X 13/16	100	
KTA156028	5/32 X 7/8	100	
KTA156030	5/32 X 15/16	100	

(continued...)

**SPLIT TENSION PINS (cont.)**

PLAIN FINISH

Line: 293-00

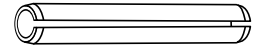

PART NUMBER	SIZE	QTY/BX	LIST PRICE
KTA156032	5/32 X 1	100	
KTA156036	5/32 X 1 1/8	50	
KTA156040	5/32 X 1 1/4	50	
KTA156044	5/32 X 1 3/8	50	
KTA156048	5/32 X 1 1/2	50	
KTA156052	5/32 X 1 5/8	50	
KTA156056	5/32 X 1 3/4	50	
KTA156060	5/32 X 1 7/8	50	
KTA156064	5/32 X 2	50	
KTA156072	5/32 X 2 1/4	50	
KTA156080	5/32 X 2 1/2	50	
KTA03010	3/16 X 5/16	50	
KTA03012	3/16 X 3/8	50	
KTA03014	3/16 X 7/16	50	
KTA03016	3/16 X 1/2	50	
KTA03018	3/16 X 9/16	50	
KTA03020	3/16 X 5/8	50	
KTA03022	3/16 X 11/16	50	
KTA03024	3/16 X 3/4	50	
KTA03026	3/16 X 13/16	50	
KTA03028	3/16 X 7/8	50	
KTA03030	3/16 X 15/16	50	
KTA03032	3/16 X 1	50	
KTA03036	3/16 X 1 1/8	50	
KTA03040	3/16 X 1 1/4	50	
KTA03044	3/16 X 1 3/8	50	
KTA03048	3/16 X 1 1/2	50	
KTA03052	3/16 X 1 5/8	50	
KTA03056	3/16 X 1 3/4	50	
KTA03060	3/16 X 1 7/8	50	
KTA03064	3/16 X 2	50	
KTA03072	3/16 X 2 1/4	50	
KTA03080	3/16 X 2 1/2	50	
KTA03088	3/16 X 2 3/4	50	
KTA03096	3/16 X 3	50	
KTA21012	7/32 X 3/8	25	
KTA21014	7/32 X 7/16	25	
KTA21016X	7/32 X 1/2	25	
KTA21018	7/32 X 9/16	25	
KTA21020	7/32 X 5/8	25	
KTA21022	7/32 X 11/16	25	
KTA21024	7/32 X 3/4	25	
KTA21026	7/32 X 13/16	25	
KTA21028	7/32 X 7/8	25	

(continued...)

**SPLIT TENSION PINS (cont.)**

PLAIN FINISH

Line: 293-00

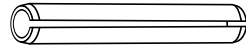

PART NUMBER	SIZE	QTY/BX	LIST PRICE
KTA21030	7/32 X 15/16	25	
KTA21032	7/32 X 1	25	
KTA21036	7/32 X 1 1/8	25	
KTA21040	7/32 X 1 1/4	25	
KTA21044	7/32 X 1 3/8	25	
KTA21048	7/32 X 1 1/2	25	
KTA21052	7/32 X 1 5/8	25	
KTA21056	7/32 X 1 3/4	25	
KTA21060	7/32 X 1 7/8	25	
KTA21064	7/32 X 2	25	
KTA21072	7/32 X 2 1/4	25	
KTA21080	7/32 X 2 1/2	25	
KTA21088	7/32 X 2 3/4	25	
KTA21096	7/32 X 3	25	
KTA04012	1/4 X 3/8	25	
KTA04014	1/4 X 7/16	25	
KTA04016	1/4 X 1/2	25	
KTA04018	1/4 X 9/16	25	
KTA04020	1/4 X 5/8	25	
KTA04022	1/4 X 11/16	25	
KTA04024	1/4 X 3/4	25	
KTA04026	1/4 X 13/16	25	
KTA04028	1/4 X 7/8	25	
KTA04030	1/4 X 15/16	25	
KTA04032	1/4 X 1	25	
KTA04036	1/4 X 1 1/8	25	
KTA04040	1/4 X 1 1/4	25	
KTA04044	1/4 X 1 3/8	25	
KTA04048	1/4 X 1 1/2	25	
KTA04052	1/4 X 1 5/8	25	
KTA04056	1/4 X 1 3/4	25	
KTA04060	1/4 X 1 7/8	25	
KTA04064	1/4 X 2	25	
KTA04072	1/4 X 2 1/4	25	
KTA04080	1/4 X 2 1/2	25	
KTA04088	1/4 X 2 3/4	25	
KTA04096	1/4 X 3	25	
KTA04104	1/4 X 3 1/4	25	
KTA04112	1/4 X 3 1/2	25	
KTA04120	1/4 X 3 3/4	25	
KTA04128	1/4 X 4	25	
KTA04144	1/4 X 4 1/2	25	
KTA05012	5/16 X 3/8	25	
KTA05014	5/16 X 7/16	25	

(continued...)

**SPLIT TENSION PINS (cont.)**

PLAIN FINISH

Line: 293-00

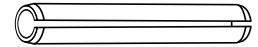

PART NUMBER	SIZE	QTY/BX	LIST PRICE
KTA05018	5/16 X 9/16	25	
KTA05020	5/16 X 5/8	25	
KTA05024	5/16 X 3/4	25	
KTA05026	5/16 X 13/16	25	
KTA05028	5/16 X 7/8	25	
KTA05030	5/16 X 15/16	25	
KTA05032	5/16 X 1	25	
KTA05036	5/16 X 1 1/8	25	
KTA05040	5/16 X 1 1/4	25	
KTA05044	5/16 X 1 3/8	25	
KTA05048	5/16 X 1 1/2	25	
KTA05052	5/16 X 1 5/8	25	
KTA05056	5/16 X 1 3/4	25	
KTA05060	5/16 X 1 7/8	25	
KTA05064	5/16 X 2	25	
KTA05072	5/16 X 2 1/4	25	
KTA05080	5/16 X 2 1/2	25	
KTA05088	5/16 X 2 3/4	25	
KTA05096	5/16 X 3	25	
KTA05104	5/16 X 3 1/4	25	
KTA05112	5/16 X 3 1/2	25	
KTA05128	5/16 X 4	25	
KTA06016	3/8 X 1/2	25	
KTA06024	3/8 X 3/4	25	
KTA06028	3/8 X 7/8	25	
KTA06032	3/8 X 1	25	
KTA06036	3/8 X 1 1/8	25	
KTA06040	3/8 X 1 1/4	25	
KTA06044X	3/8 X 1 3/8	25	
KTA06048	3/8 X 1 1/2	25	
KTA06052X	3/8 X 1 5/8	25	
KTA06056	3/8 X 1 3/4	25	
KTA06060X	3/8 X 1 7/8	25	
KTA06064	3/8 X 2	25	
KTA06072	3/8 X 2 1/4	25	
KTA06080	3/8 X 2 1/2	25	
KTA06088	3/8 X 2 3/4	25	
KTA06096	3/8 X 3	25	
KTA06104	3/8 X 3 1/4	25	
KTA06112	3/8 X 3 1/2	25	
KTA06120	3/8 X 3 3/4	25	
KTA06128	3/8 X 4	25	
KTA06144	3/8 X 4 1/2	25	
KTA07032	7/16 X 1	25	

(continued...)

## SPLIT TENSION PINS (cont.)

PLAIN FINISH

Line: 293-00

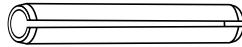

PART NUMBER	SIZE	QTY/BX	LIST PRICE
KTA07040	7/16 X 1 1/4	25	
KTA07048	7/16 X 1 1/2	25	
KTA07052	7/16 X 1 5/8	25	
KTA07056	7/16 X 1 3/4	25	
KTA07060	7/16 X 1 7/8	25	
KTA07064	7/16 X 2	25	
KTA07072	7/16 X 2 1/4	25	
KTA07080	7/16 X 2 1/2	25	
KTA07088	7/16 X 2 3/4	25	
KTA07096	7/16 X 3	25	
KTA07104	7/16 X 3 1/4	25	
KTA07112	7/16 X 3 1/2	25	
KTA07128	7/16 X 4	25	
KTA08024	1/2 X 3/4	25	
KTA08028	1/2 X 7/8	25	
KTA08032	1/2 X 1	25	
KTA08036	1/2 X 1 1/8	25	
KTA08040	1/2 X 1 1/4	25	
KTA08044	1/2 X 1 3/8	25	
KTA08048	1/2 X 1 1/2	25	
KTA08052	1/2 X 1 5/8	25	
KTA08056	1/2 X 1 3/4	25	
KTA08060	1/2 X 1 7/8	25	
KTA08064	1/2 X 2	25	
KTA08072	1/2 X 2 1/4	25	
KTA08080	1/2 X 2 1/2	25	
KTA08088	1/2 X 2 3/4	25	
KTA08096	1/2 X 3	25	
KTA08104	1/2 X 3 1/4	25	
KTA08112	1/2 X 3 1/2	25	
KTA08128	1/2 X 4	25	
KTA08144	1/2 X 4 1/2	25	
KTA10080	5/8 X 2 1/2	25	

## METRIC SPLIT TENSION PINS

PLAIN FINISH - DIN #1481

Line: 293-01

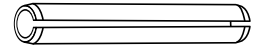

PART NUMBER	SIZE	QTY/BX	LIST PRICE
BTL02005	M2 X 5	100	
BTL02010	M2 X 10	100	
BTL02012	M2 X 12	100	
BTL02014	M2 X 14	100	
BTL02018	M2 X 18	100	
BTL02020	M2 X 20	100	
BTL025010	M2.5 X 10	100	
BTL025022	M2.5 X 22	100	
BTL025026	M2.5 X 26	100	
BTL03012	M3 X 12	100	
BTL03020	M3 X 20	100	
BTL03022	M3 X 22	100	
BTL03036	M3 X 36	100	
BTL035012	M3.5 X 12	100	
BTL035018	M3.5 X 18	100	
BTL035022	M3.5 X 22	100	
BTL035028	M3.5 X 28	100	
BTL04014	M4 X 14	100	
BTL04016	M4 X 16	100	
BTL04020	M4 X 20	100	
BTL04024	M4 X 24	100	
BTL04026	M4 X 26	100	
BTL04036	M4 X 36	100	
BTL045010	M4.5 X 10	100	
BTL05014	M5 X 14	100	
BTL05025	M5 X 25	100	
BTL05026	M5 X 26	100	
BTL06026	M6 X 26	50	
BTL06040	M6 X 40	50	
BTL06050	M6 X 50	50	
BTL06075	M6 X 75	25	

## SPLIT TENSION PINS

ZINC PLATED

Line: 295-00

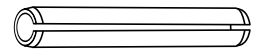

PART NUMBER	SIZE	QTY/BX	LIST PRICE
KUA01006	1/16 X 3/16	100	
KUA01008	1/16 X 1/4	100	
KUA01010	1/16 X 5/16	100	
KUA01012	1/16 X 3/8	100	
KUA01014	1/16 X 7/16	100	
KUA01016	1/16 X 1/2	100	
KUA01018	1/16 X 9/16	100	
KUA01020	1/16 X 5/8	100	
KUA01022	1/16 X 11/16	100	

(continued...)

**SPLIT TENSION PINS (cont.)**

ZINC PLATED

Line: 295-00

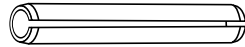

PART NUMBER	SIZE	QTY/BX	LIST PRICE
KUA01024	1/16 X 3/4	100	
KUA01026	1/16 X 13/16	100	
KUA01028	1/16 X 7/8	100	
KUA01030	1/16 X 15/16	100	
KUA01032	1/16 X 1	100	
KUA78006	5/64 X 3/16	100	
KUA78008	5/64 X 1/4	100	
KUA78010	5/64 X 5/16	100	
KUA78012	5/64 X 3/8	100	
KUA78014	5/64 X 7/16	100	
KUA78016	5/64 X 1/2	100	
KUA78018	5/64 X 9/16	100	
KUA78020	5/64 X 5/8	100	
KUA78022	5/64 X 11/16	100	
KUA78024	5/64 X 3/4	100	
KUA78026	5/64 X 13/16	100	
KUA78028	5/64 X 7/8	100	
KUA78030	5/64 X 15/16	100	
KUA78032	5/64 X 1	100	
KUA78036	5/64 X 1 1/8	100	
KUA78040	5/64 X 1 1/4	100	
KUA78044	5/64 X 1 3/8	100	
KUA78048	5/64 X 1 1/2	100	
KUA93006	3/32 X 3/16	100	
KUA93008	3/32 X 1/4	100	
KUA93010	3/32 X 5/16	100	
KUA93012	3/32 X 3/8	100	
KUA93014	3/32 X 7/16	100	
KUA93016	3/32 X 1/2	100	
KUA93018	3/32 X 9/16	100	
KUA93020	3/32 X 5/8	100	
KUA93022	3/32 X 11/16	100	
KUA93024	3/32 X 3/4	100	
KUA93026	3/32 X 13/16	100	
KUA93028	3/32 X 7/8	100	
KUA93030	3/32 X 15/16	100	
KUA93032	3/32 X 1	100	
KUA93036	3/32 X 1 1/8	100	
KUA93040	3/32 X 1 1/4	100	
KUA93044	3/32 X 1 3/8	100	
KUA93048	3/32 X 1 1/2	100	
KUA02008	1/8 X 1/4	100	
KUA02010	1/8 X 5/16	100	
KUA02012	1/8 X 3/8	100	

(continued...)

**SPLIT TENSION PINS (cont.)**

ZINC PLATED

Line: 295-00

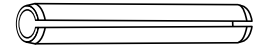

PART NUMBER	SIZE	QTY/BX	LIST PRICE
KUA02014	1/8 X 7/16	100	
KUA02016	1/8 X 1/2	100	
KUA02018	1/8 X 9/16	100	
KUA02020	1/8 X 5/8	100	
KUA02022	1/8 X 11/16	100	
KUA02024	1/8 X 3/4	100	
KUA02026	1/8 X 13/16	100	
KUA02028	1/8 X 7/8	100	
KUA02030	1/8 X 15/16	100	
KUA02032	1/8 X 1	100	
KUA02036	1/8 X 1 1/8	100	
KUA02040	1/8 X 1 1/4	100	
KUA02044	1/8 X 1 3/8	100	
KUA02048	1/8 X 1 1/2	100	
KUA02052	1/8 X 1 5/8	100	
KUA02056	1/8 X 1 3/4	100	
KUA02060	1/8 X 1 7/8	100	
KUA02064	1/8 X 2	100	
KUA02080	1/8 X 2 1/2	100	
KUA156012	5/32 X 3/8	100	
KUA156014	5/32 X 7/16	100	
KUA156016	5/32 X 1/2	100	
KUA156018	5/32 X 9/16	100	
KUA156020	5/32 X 5/8	100	
KUA156022	5/32 X 11/16	100	
KUA156024	5/32 X 3/4	100	
KUA156026	5/32 X 13/16	100	
KUA156028	5/32 X 7/8	100	
KUA156030	5/32 X 15/16	100	
KUA156032	5/32 X 1	100	
KUA156036	5/32 X 1 1/8	50	
KUA156040	5/32 X 1 1/4	50	
KUA156044	5/32 X 1 3/8	50	
KUA156048	5/32 X 1 1/2	50	
KUA156052	5/32 X 1 5/8	50	
KUA156056	5/32 X 1 3/4	50	
KUA156060	5/32 X 1 7/8	50	
KUA156064	5/32 X 2	50	
KUA156072	5/32 X 2 1/4	50	
KUA156080	5/32 X 2 1/2	25	
KUA03012	3/16 X 3/8	50	
KUA03014	3/16 X 7/16	50	
KUA03016	3/16 X 1/2	50	
KUA03018	3/16 X 9/16	50	

(continued...)

**SPLIT TENSION PINS (cont.)**

ZINC PLATED

Line: 295-00

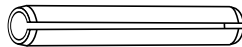

PART NUMBER	SIZE	QTY/BX	LIST PRICE
KUA03020	3/16 X 5/8	50	
KUA03022	3/16 X 11/16	50	
KUA03024	3/16 X 3/4	50	
KUA03026	3/16 X 13/16	50	
KUA03028	3/16 X 7/8	50	
KUA03030	3/16 X 15/16	50	
KUA03032	3/16 X 1	50	
KUA03036	3/16 X 1 1/8	50	
KUA03040	3/16 X 1 1/4	50	
KUA03044	3/16 X 1 3/8	50	
KUA03048	3/16 X 1 1/2	50	
KUA03052	3/16 X 1 5/8	50	
KUA03056	3/16 X 1 3/4	50	
KUA03060	3/16 X 1 7/8	50	
KUA03064	3/16 X 2	50	
KUA03072	3/16 X 2 1/4	50	
KUA03080	3/16 X 2 1/2	50	
KUA03096	3/16 X 3	50	
KUA21016	7/32 X 1/2	25	
KUA21018	7/32 X 9/16	25	
KUA21020	7/32 X 5/8	25	
KUA21022	7/32 X 11/16	25	
KUA21024	7/32 X 3/4	25	
KUA21026	7/32 X 13/16	25	
KUA21028	7/32 X 7/8	25	
KUA21030	7/32 X 15/16	25	
KUA21032	7/32 X 1	25	
KUA21036	7/32 X 1 1/8	25	
KUA21040	7/32 X 1 1/4	25	
KUA21044	7/32 X 1 3/8	25	
KUA21048	7/32 X 1 1/2	25	
KUA21052	7/32 X 1 5/8	25	
KUA21056	7/32 X 1 3/4	25	
KUA21060	7/32 X 1 7/8	25	
KUA21064	7/32 X 2	25	
KUA21072	7/32 X 2 1/4	25	
KUA21080	7/32 X 2 1/2	25	
KUA21088	7/32 X 2 3/4	25	
KUA21096	7/32 X 3	25	
KUA04016	1/4 X 1/2	25	
KUA04020	1/4 X 5/8	25	
KUA04022	1/4 X 11/16	25	
KUA04024	1/4 X 3/4	25	
KUA04026	1/4 X 13/16	25	

(continued...)

**SPLIT TENSION PINS (cont.)**

ZINC PLATED

Line: 295-00

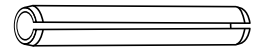

PART NUMBER	SIZE	QTY/BX	LIST PRICE
KUA04028	1/4 X 7/8	25	
KUA04030	1/4 X 15/16	25	
KUA04032	1/4 X 1	25	
KUA04036	1/4 X 1 1/8	25	
KUA04040	1/4 X 1 1/4	25	
KUA04044	1/4 X 1 3/8	25	
KUA04048	1/4 X 1 1/2	25	
KUA04052	1/4 X 1 5/8	25	
KUA04056	1/4 X 1 3/4	25	
KUA04060	1/4 X 1 7/8	25	
KUA04064	1/4 X 2	25	
KUA04072	1/4 X 2 1/4	25	
KUA04080	1/4 X 2 1/2	25	
KUA04088	1/4 X 2 3/4	25	
KUA04096	1/4 X 3	25	
KUA04104	1/4 X 3 1/4	25	
KUA04112	1/4 X 3 1/2	25	
KUA05024	5/16 X 3/4	25	
KUA05026	5/16 X 13/16	25	
KUA05028	5/16 X 7/8	25	
KUA05030	5/16 X 15/16	25	
KUA05032	5/16 X 1	25	
KUA05036	5/16 X 1 1/8	25	
KUA05040	5/16 X 1 1/4	25	
KUA05044	5/16 X 1 3/8	25	
KUA05048	5/16 X 1 1/2	25	
KUA05052	5/16 X 1 5/8	25	
KUA05056	5/16 X 1 3/4	25	
KUA05060	5/16 X 1 7/8	25	
KUA05064	5/16 X 2	25	
KUA05072	5/16 X 2 1/4	25	
KUA05080	5/16 X 2 1/2	25	
KUA05088	5/16 X 2 3/4	25	
KUA05096	5/16 X 3	25	
KUA05104	5/16 X 3 1/4	25	
KUA05112	5/16 X 3 1/2	25	
KUA05120	5/16 X 3 3/4	25	
KUA05128	5/16 X 4	25	
KUA06024	3/8 X 3/4	25	
KUA06026	3/8 X 13/16	25	
KUA06030	3/8 X 15/16	25	
KUA06032	3/8 X 1	25	
KUA06036	3/8 X 1 1/8	25	
KUA06040	3/8 X 1 1/4	25	

(continued...)

**SPLIT TENSION PINS (cont.)**

ZINC PLATED

Line: 295-00

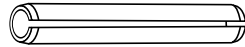

PART NUMBER	SIZE	QTY/BX	LIST PRICE
KUA06044	3/8 X 1 3/8	25	
KUA06048	3/8 X 1 1/2	25	
KUA06052	3/8 X 1 5/8	25	
KUA06056	3/8 X 1 3/4	25	
KUA06060	3/8 X 1 7/8	25	
KUA06064	3/8 X 2	25	
KUA06072	3/8 X 2 1/4	25	
KUA06080	3/8 X 2 1/2	25	
KUA06088	3/8 X 2 3/4	25	
KUA06096	3/8 X 3	25	
KUA06104	3/8 X 3 1/4	25	
KUA06112	3/8 X 3 1/2	25	
KUA06120	3/8 X 3 3/4	25	
KUA06128	3/8 X 4	25	
KUA07032	7/16 X 1	25	
KUA07036	7/16 X 1 1/8	25	
KUA07040	7/16 X 1 1/4	25	
KUA07044	7/16 X 1 3/8	25	
KUA07048	7/16 X 1 1/2	25	
KUA07052	7/16 X 1 5/8	25	
KUA07056	7/16 X 1 3/4	25	
KUA07064	7/16 X 2	25	
KUA07072	7/16 X 2 1/4	25	
KUA07080	7/16 X 2 1/2	25	
KUA07088	7/16 X 2 3/4	25	
KUA07096	7/16 X 3	25	
KUA07104	7/16 X 3 1/4	25	
KUA07112	7/16 X 3 1/2	25	
KUA07120	7/16 X 3 3/4	25	
KUA07128	7/16 X 4	25	
KUA08032	1/2 X 1	25	
KUA08040	1/2 X 1 1/4	25	
KUA08044	1/2 X 1 3/8	25	
KUA08048	1/2 X 1 1/2	25	
KUA08052	1/2 X 1 5/8	25	
KUA08056	1/2 X 1 3/4	25	
KUA08064	1/2 X 2	25	
KUA08072	1/2 X 2 1/4	25	
KUA08080	1/2 X 2 1/2	25	
KUA08088	1/2 X 2 3/4	25	
KUA08096	1/2 X 3	25	
KUA08104	1/2 X 3 1/4	25	
KUA08112	1/2 X 3 1/2	25	
KUA08120	1/2 X 3 3/4	25	

(continued...)

**SPLIT TENSION PINS (cont.)**

ZINC PLATED

Line: 295-00

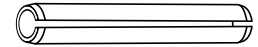

PART NUMBER	SIZE	QTY/BX	LIST PRICE
KUA08128	1/2 X 4	25	
KUA08160	1/2 X 5	25	

**SPIRAL ROLL SPRING PINS**

PLAIN FINISH

Line: 295-01

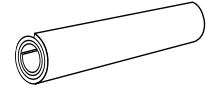

PART NUMBER	SIZE	QTY/BX	LIST PRICE
JWG01008	1/16 X 1/4	100	
JWG01010	1/16 X 5/16	100	
JWG01012	1/16 X 3/8	100	
JWG01014	1/16 X 7/16	100	
JWG01016	1/16 X 1/2	100	
JWG01018	1/16 X 9/16	100	
JWG01020	1/16 X 5/8	100	
JWG01022	1/16 X 11/16	100	
JWG01024	1/16 X 3/4	100	
JWG01028	1/16 X 7/8	100	
JWG01030	1/16 X 15/16	100	
JWG01032	1/16 X 1	100	
JWG78010	5/64 X 5/16	100	
JWG78012	5/64 X 3/8	100	
JWG78014	5/64 X 7/16	100	
JWG78016	5/64 X 1/2	100	
JWG78018	5/64 X 9/16	100	
JWG78020	5/64 X 5/8	100	
JWG78022	5/64 X 11/16	100	
JWG78024	5/64 X 3/4	100	
JWG78028	5/64 X 7/8	100	
JWG78030	5/64 X 15/16	100	
JWG78032	5/64 X 1	100	
JWG78040	5/64 X 1 1/4	100	
JWG93010X	3/32 X 5/16	100	
JWG93012	3/32 X 3/8	100	
JWG93014	3/32 X 7/16	100	
JWG93016	3/32 X 1/2	100	
JWG93018	3/32 X 9/16	100	
JWG93020	3/32 X 5/8	100	
JWG93022	3/32 X 11/16	100	
JWG93024	3/32 X 3/4	100	
JWG93028	3/32 X 7/8	100	
JWG93030	3/32 X 15/16	100	
JWG93032	3/32 X 1	100	
JWG93036	3/32 X 1 1/8	100	
JWG93040	3/32 X 1 1/4	100	
JWG93044	3/32 X 1 3/8	100	

(continued...)



**SPIRAL ROLL SPRING PINS (cont.)**

PLAIN FINISH

Line: 295-01

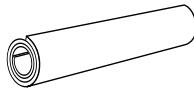

PART NUMBER	SIZE	QTY/BX	LIST PRICE
JWG93048	3/32 X 1 1/2	100	
JWG93052	3/32 X 1 5/8	100	
JWG93056	3/32 X 1 3/4	100	
JWG02010	1/8 X 5/16	100	
JWG02012X	1/8 X 3/8	100	
JWG02014	1/8 X 7/16	100	
JWG02016X	1/8 X 1/2	100	
JWG02018	1/8 X 9/16	100	
JWG02020	1/8 X 5/8	100	
JWG02022	1/8 X 11/16	100	
JWG02024X	1/8 X 3/4	100	
JWG02028	1/8 X 7/8	100	
JWG02030	1/8 X 15/16	100	
JWG02032	1/8 X 1	100	
JWG02036	1/8 X 1 1/8	100	
JWG02040X	1/8 X 1 1/4	100	
JWG02044	1/8 X 1 3/8	100	
JWG02048	1/8 X 1 1/2	100	
JWG02052	1/8 X 1 5/8	100	
JWG02056	1/8 X 1 3/4	100	
JWG02064	1/8 X 2	100	
JWG156012	5/32 X 3/8	100	
JWG156014	5/32 X 7/16	100	
JWG156016	5/32 X 1/2	100	
JWG156018	5/32 X 9/16	100	
JWG156020	5/32 X 5/8	100	
JWG156022X	5/32 X 11/16	100	
JWG156024	5/32 X 3/4	100	
JWG156028	5/32 X 7/8	100	
JWG156030	5/32 X 15/16	100	
JWG156032	5/32 X 1	100	
JWG156036	5/32 X 1 1/8	100	
JWG156040	5/32 X 1 1/4	100	
JWG156044	5/32 X 1 3/8	100	
JWG156048	5/32 X 1 1/2	50	
JWG156052	5/32 X 1 5/8	50	
JWG156056	5/32 X 1 3/4	50	
JWG156064	5/32 X 2	50	
JWG03016	3/16 X 1/2	50	
JWG03018	3/16 X 9/16	100	
JWG03020	3/16 X 5/8	50	
JWG03022	3/16 X 11/16	50	
JWG03024	3/16 X 3/4	50	
JWG03028	3/16 X 7/8	50	

(continued...)

**SPIRAL ROLL SPRING PINS (cont.)**

PLAIN FINISH

Line: 295-01

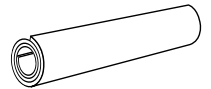

PART NUMBER	SIZE	QTY/BX	LIST PRICE
JWG03030	3/16 X 15/16	50	
JWG03032	3/16 X 1	50	
JWG03036	3/16 X 1 1/8	50	
JWG03040	3/16 X 1 1/4	50	
JWG03044	3/16 X 1 3/8	50	
JWG03048	3/16 X 1 1/2	50	
JWG03052	3/16 X 1 5/8	100	
JWG03056	3/16 X 1 3/4	50	
JWG03064	3/16 X 2	50	
JWG03072	3/16 X 2 1/4	50	
JWG03080	3/16 X 2 1/2	50	
JWG21020	7/32 X 5/8	50	
JWG21022	7/32 X 11/16	100	
JWG21024	7/32 X 3/4	50	
JWG21028	7/32 X 7/8	100	
JWG21030	7/32 X 15/16	100	
JWG21032	7/32 X 1	50	
JWG21036	7/32 X 1 1/8	50	
JWG21040	7/32 X 1 1/4	50	
JWG21044	7/32 X 1 3/8	100	
JWG21048	7/32 X 1 1/2	50	
JWG21052	7/32 X 1 5/8	100	
JWG21056	7/32 X 1 3/4	50	
JWG21064	7/32 X 2	50	
JWG21072	7/32 X 2 1/4	100	
JWG21080	7/32 X 2 1/2	100	
JWG04016	1/4 X 1/2	50	
JWG04018	1/4 X 9/16	50	
JWG04020	1/4 X 5/8	50	
JWG04022	1/4 X 11/16	50	
JWG04024	1/4 X 3/4	50	
JWG04028	1/4 X 7/8	50	
JWG04030	1/4 X 15/16	50	
JWG04032	1/4 X 1	50	
JWG04036	1/4 X 1 1/8	50	
JWG04040	1/4 X 1 1/4	50	
JWG04044	1/4 X 1 3/8	50	
JWG04048X	1/4 X 1 1/2	50	
JWG04052	1/4 X 1 5/8	25	
JWG04056	1/4 X 1 3/4	25	
JWG04064	1/4 X 2	25	
JWG04072	1/4 X 2 1/4	25	
JWG04080	1/4 X 2 1/2	25	
JWG04096X	1/4 X 3	25	

(continued...)

## SPIRAL ROLL SPRING PINS (cont)

PLAIN FINISH

Line: 295-01

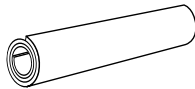

PART NUMBER	SIZE	QTY/BX	LIST PRICE
JWG05024	5/16 X 3/4	50	
JWG05028	5/16 X 7/8	50	
JWG05030	5/16 X 15/16	50	
JWG05032	5/16 X 1	50	
JWG05036	5/16 X 1 1/8	50	
JWG05040	5/16 X 1 1/4	50	
JWG05044	5/16 X 1 3/8	50	
JWG05048	5/16 X 1 1/2	25	
JWG05052	5/16 X 1 5/8	25	
JWG05056	5/16 X 1 3/4	25	
JWG05064	5/16 X 2	25	
JWG05072	5/16 X 2 1/4	25	
JWG05080	5/16 X 2 1/2	25	
JWG05096X	5/16 X 3	25	
JWG06024X	3/8 X 3/4	25	
JWG06032	3/8 X 1	25	
JWG06064X	3/8 X 2	25	

## UNIVERSAL CLEVIS PINS

PLAIN FINISH

Line: 298-00

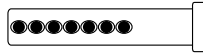

PART NUMBER	SIZE	QTY/BX	LIST PRICE
KNA03032	3/16 X 1	25	
KNA03048	3/16 X 1 1/2	25	
KNA03064	3/16 X 2	25	
KNA04032	1/4 X 1	25	
KNA04048	1/4 X 1 1/2	25	
KNA04064	1/4 X 2	25	
KNA04080	1/4 X 2 1/2	25	
KNA04096	1/4 X 3	25	
KNA05048	5/16 X 1 1/2	25	
KNA05064	5/16 X 2	25	
KNA05080	5/16 X 2 1/2	25	
KNA05096	5/16 X 3	25	
KNA05112	5/16 X 3 1/2	25	
KNA06032	3/8 X 1	25	
KNA06048	3/8 X 1 1/2	25	
KNA06064	3/8 X 2	25	
KNA06080	3/8 X 2 1/2	25	
KNA06096	3/8 X 3	25	
KNA06112	3/8 X 3 1/2	25	
KNA06128	3/8 X 4	25	
KNA07064	7/16 X 2	25	
KNA07080	7/16 X 2 1/2	25	
KNA07096	7/16 X 3	25	

(continued...)

## UNIVERSAL CLEVIS PINS (cont.)

PLAIN FINISH

Line: 298-00

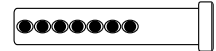

PART NUMBER	SIZE	QTY/BX	LIST PRICE
KNA07128	7/16 X 4	25	
KNA08064	1/2 X 2	25	
KNA08080	1/2 X 2 1/2	25	
KNA08096	1/2 X 3	25	
KNA08112	1/2 X 3 1/2	25	
KNA08128	1/2 X 4	25	
KNA09128	9/16 X 4	10	
KNA10064	5/8 X 2	10	
KNA10096	5/8 X 3	10	
KNA10128	5/8 X 4	10	

## ONE HOLE CLEVIS PINS

PLAIN FINISH

Line: 299-00

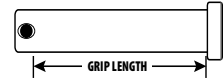

PART NUMBER	SIZE	QTY/BX	LIST PRICE
KLA03019	3/16 X 19/32	25	
KLA03020	3/16 X 5/8	25	
KLA03024	3/16 X 3/4	25	
KLA03028	3/16 X 7/8	25	
KLA03032	3/16 X 1	25	
KLA03036	3/16 X 1 1/8	25	
KLA03048X	3/16 X 1 1/2	25	
KLA03056X	3/16 X 1 3/4	25	
KLA03064	3/16 X 2	25	
KLA03080	3/16 X 2 1/2	25	
KLA04016	1/4 X 1/2	25	
KLA04020	1/4 X 5/8	25	
KLA04024	1/4 X 3/4	25	
KLA04025	1/4 X 51/64	25	
KLA04028	1/4 X 7/8	25	
KLA04032	1/4 X 1	25	
KLA04036	1/4 X 1 1/8	25	
KLA04040	1/4 X 1 1/4	25	
KLA04044	1/4 X 1 3/8	25	
KLA04048	1/4 X 1 1/2	25	
KLA04052	1/4 X 1 5/8	25	
KLA04056	1/4 X 1 3/4	25	
KLA04064	1/4 X 2	25	
KLA04068	1/4 X 2 1/8	25	
KLA04072	1/4 X 2 1/4	25	
KLA04076	1/4 X 2 3/8	25	
KLA04078	1/4 X 2 7/16	25	
KLA04080	1/4 X 2 1/2	25	
KLA04084	1/4 X 2 5/8	25	

(continued...)

# ONE HOLE CLEVIS PINS (cont.)

PLAIN FINISH

Line: 299-00

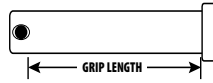

PART NUMBER	SIZE	QTY/BX	LIST PRICE
KLA04088	1/4 X 2 3/4	25	
KLA04096	1/4 X 3	25	
KLA04112	1/4 X 3 1/2	25	
KLA04128	1/4 X 4	25	
KLA04160	1/4 X 5	25	
KLA05016	5/16 X 1/2	25	
KLA05024	5/16 X 3/4	25	
KLA05028	5/16 X 7/8	25	
KLA05031	5/16 X 31/32	25	
KLA05032	5/16 X 1	25	
KLA05036	5/16 X 1 1/8	25	
KLA05038	5/16 X 1 3/16	25	
KLA05040	5/16 X 1 1/4	25	
KLA05044	5/16 X 1 3/8	25	
KLA05048	5/16 X 1 1/2	25	
KLA05052	5/16 X 1 5/8	25	
KLA05054	5/16 X 1 11/16	25	
KLA05056	5/16 X 1 3/4	25	
KLA05058	5/16 X 1 13/16	25	
KLA05060	5/16 X 1 7/8	25	
KLA05062	5/16 X 1 15/16	25	
KLA05064	5/16 X 2	25	
KLA05068	5/16 X 2 1/8	25	
KLA05070	5/16 X 2 3/16	25	
KLA05072	5/16 X 2 1/4	25	
KLA05076	5/16 X 2 3/8	25	
KLA05080	5/16 X 2 1/2	25	
KLA05084	5/16 X 2 5/8	25	
KLA05088	5/16 X 2 3/4	25	
KLA05090	5/16 X 2 13/16	25	
KLA05092	5/16 X 2 7/8	25	
KLA05096	5/16 X 3	25	
KLA05100	5/16 X 3 1/8	25	
KLA05104	5/16 X 3 1/4	25	
KLA05112	5/16 X 3 1/2	25	
KLA05128	5/16 X 4	25	
KLA06024	3/8 X 3/4	25	
KLA06032	3/8 X 1	25	
KLA06035	3/8 X 1 3/32	25	
KLA06036	3/8 X 1 1/8	25	
KLA06040	3/8 X 1 1/4	25	
KLA06042	3/8 X 1 5/16	25	
KLA06044	3/8 X 1 3/8	25	
KLA06048	3/8 X 1 1/2	25	

(continued...)

# ONE HOLE CLEVIS PINS (cont.)

PLAIN FINISH

Line: 299-00



PART NUMBER	SIZE	QTY/BX	LIST PRICE
KLA06052	3/8 X 1 5/8	25	
KLA06056	3/8 X 1 3/4	25	
KLA06060	3/8 X 1 7/8	25	
KLA06064	3/8 X 2	25	
KLA06068	3/8 X 2 1/8	25	
KLA06072	3/8 X 2 1/4	25	
KLA06075	3/8 X 2 23/64	25	
KLA06076	3/8 X 2 3/8	25	
KLA06080	3/8 X 2 1/2	25	
KLA06084	3/8 X 2 5/8	25	
KLA06088	3/8 X 2 3/4	25	
KLA06096	3/8 X 3	25	
KLA06104	3/8 X 3 1/4	25	
KLA06112	3/8 X 3 1/2	25	
KLA06120	3/8 X 3 3/4	25	
KLA06128	3/8 X 4	25	
KLA07032	7/16 X 1	25	
KLA07038	7/16 X 1 15/64	25	
KLA07040	7/16 X 1 1/4	25	
KLA07048	7/16 X 1 1/2	25	
KLA07052	7/16 X 1 5/8	25	
KLA07056	7/16 X 1 3/4	25	
KLA07064	7/16 X 2	25	
KLA07072	7/16 X 2 1/4	25	
KLA07076	7/16 X 2 3/8	25	
KLA07080	7/16 X 2 1/2	25	
KLA07084	7/16 X 2 5/8	25	
KLA07088	7/16 X 2 3/4	25	
KLA07096	7/16 X 3	25	
KLA07112	7/16 X 3 1/2	25	
KLA07128	7/16 X 4	25	
KLA08032	1/2 X 1	25	
KLA08040	1/2 X 1 1/4	25	
KLA08046	1/2 X 1 27/64	25	
KLA08048	1/2 X 1 1/2	25	
KLA08056	1/2 X 1 3/4	25	
KLA08064	1/2 X 2	25	
KLA08072	1/2 X 2 1/4	25	
KLA08080	1/2 X 2 1/2	25	
KLA08084	1/2 X 2 5/8	25	
KLA08088	1/2 X 2 3/4	25	
KLA08096	1/2 X 3	25	
KLA08112	1/2 X 3 1/2	25	
KLA08128	1/2 X 4	25	

(continued...)

# ONE HOLE CLEVIS PINS (cont.)

PLAIN FINISH

Line: 299-00



PART NUMBER	SIZE	QTY/BX	LIST PRICE
KLA08144	1/2 X 4 1/2	25	
KLA08160	1/2 X 5	25	
KLA08192	1/2 X 6	25	
KLA09064	9/16 X 2	10	
KLA09080	9/16 X 2 1/2	10	
KLA09096	9/16 X 3	10	
KLA10040	5/8 X 1 1/4	10	
KLA10048	5/8 X 1 1/2	10	
KLA10056	5/8 X 1 3/4	10	
KLA10061	5/8 X 1 25/32	10	
KLA10064	5/8 X 2	10	
KLA10072	5/8 X 2 1/4	10	
KLA10080	5/8 X 2 1/2	10	
KLA10096	5/8 X 3	10	
KLA10112	5/8 X 3 1/2	10	
KLA10128	5/8 X 4	10	
KLA12064	3/4 X 2	10	
KLA12080	3/4 X 2 1/2	10	
KLA12088	3/4 X 2 3/4	10	
KLA12096	3/4 X 3	10	
KLA12112	3/4 X 3 1/2	10	
KLA12120	3/4 X 3 3/4	10	
KLA12128	3/4 X 4	10	
KLA12144	3/4 X 4 1/2	10	
KLA12160	3/4 X 5	10	
KLA12176	3/4 X 5 1/2	10	
KLA12208	3/4 X 6 1/2	10	
KLA14064	7/8 X 2	5	
KLA14080	7/8 X 2 1/2	5	
KLA14096	7/8 X 3	5	
KLA14112	7/8 X 3 1/2	5	
KLA14128	7/8 X 4	5	
KLA16064	1 X 2	5	
KLA16080	1 X 2 1/2	5	
KLA16088	1 X 2 3/4	5	
KLA16096	1 X 3	5	
KLA16112	1 X 3 1/2	5	
KLA16128	1 X 4	5	
KLA16144	1 X 4 1/2	5	
KLA16192	1 X 6	5	
KLA18096	1 1/8 X 3	5	
KLA18112	1 1/8 X 3 1/2	5	
KLA20160	1 1/4 X 5	5	
KLA20192	1 1/4 X 6	5	

# ONE HOLE CLEVIS PINS

ZINC PLATED

Line: 300-00



PART NUMBER	SIZE	QTY/BX	LIST PRICE
KMA03016	3/16 X 1/2	25	
KMA03019	3/16 X 19/32	25	
KMA03020	3/16 X 5/8	25	
KMA03024	3/16 X 3/4	25	
KMA03028	3/16 X 7/8	25	
KMA03032	3/16 X 1	25	
KMA03036	3/16 X 1 1/8	25	
KMA03040	3/16 X 1 1/4	25	
KMA03056	3/16 X 1 3/4	25	
KMA03064	3/16 X 2	25	
KMA03072	3/16 X 2 1/4	25	
KMA03080	3/16 X 2 1/2	25	
KMA04016	1/4 X 1/2	25	
KMA04020	1/4 X 5/8	25	
KMA04024	1/4 X 3/4	25	
KMA04025	1/4 X 51/64	25	
KMA04028	1/4 X 7/8	25	
KMA04032	1/4 X 1	25	
KMA04036	1/4 X 1 1/8	25	
KMA04040	1/4 X 1 1/4	25	
KMA04044	1/4 X 1 3/8	25	
KMA04048	1/4 X 1 1/2	25	
KMA04052	1/4 X 1 5/8	25	
KMA04056	1/4 X 1 3/4	25	
KMA04064	1/4 X 2	25	
KMA04068	1/4 X 2 1/8	25	
KMA04072	1/4 X 2 1/4	25	
KMA04076	1/4 X 2 3/8	25	
KMA04078	1/4 X 2 7/16	25	
KMA04080	1/4 X 2 1/2	25	
KMA04084	1/4 X 2 5/8	25	
KMA04088	1/4 X 2 3/4	25	
KMA04096	1/4 X 3	25	
KMA04104	1/4 X 3 1/4	25	
KMA04112	1/4 X 3 1/2	25	
KMA04120X	1/4 X 3 3/4 RD HD	1	
KMA04128	1/4 X 4	25	
KMA04160	1/4 X 5	25	
KMA05016	5/16 X 1/2 (Y/Z)	25	
KMA05024	5/16 X 3/4	25	
KMA05031	5/16 X 31/32	25	
KMA05032	5/16 X 1	25	
KMA05036	5/16 X 1 1/8	25	
KMA05038	5/16 X 1 3/16	25	

(continued...)

# ONE HOLE CLEVIS PINS (cont.)

ZINC PLATED

Line: 300-00



PART NUMBER	SIZE	QTY/BX	LIST PRICE
KMA05040	5/16 X 1 1/4	25	
KMA05044	5/16 X 1 3/8	25	
KMA05048	5/16 X 1 1/2	25	
KMA05052	5/16 X 1 5/8	25	
KMA05054	5/16 X 1 11/16	25	
KMA05056	5/16 X 1 3/4	25	
KMA05058	5/16 X 1 13/16	25	
KMA05060	5/16 X 1 7/8	25	
KMA05062	5/16 X 1 15/16	25	
KMA05064	5/16 X 2	25	
KMA05068	5/16 X 2 1/8	25	
KMA05070	5/16 X 2 3/16	25	
KMA05072	5/16 X 2 1/4	25	
KMA05076	5/16 X 2 3/8	25	
KMA05080	5/16 X 2 1/2	25	
KMA05084	5/16 X 2 5/8	25	
KMA05088	5/16 X 2 3/4	25	
KMA05090	5/16 X 2 13/16	25	
KMA05092	5/16 X 2 7/8	25	
KMA05096	5/16 X 3	25	
KMA05100	5/16 X 3 1/8	25	
KMA05104	5/16 X 3 1/4	25	
KMA05112	5/16 X 3 1/2	25	
KMA05128	5/16 X 4	25	
KMA06024	3/8 X 3/4	25	
KMA06032	3/8 X 1	25	
KMA06035	3/8 X 1 3/32	25	
KMA06036	3/8 X 1 1/8	25	
KMA06040	3/8 X 1 1/4	25	
KMA06042	3/8 X 1 5/16	25	
KMA06044	3/8 X 1 3/8	25	
KMA06048	3/8 X 1 1/2	25	
KMA06052	3/8 X 1 5/8	25	
KMA06056	3/8 X 1 3/4	25	
KMA06060	3/8 X 1 7/8	25	
KMA06064	3/8 X 2	25	
KMA06068	3/8 X 2 1/8	25	
KMA06072	3/8 X 2 1/4	25	
KMA06075	3/8 X 2 23/64	25	
KMA06076	3/8 X 2 3/8	25	
KMA06080	3/8 X 2 1/2	25	
KMA06084	3/8 X 2 5/8	25	
KMA06088	3/8 X 2 3/4	25	
KMA06096	3/8 X 3	25	

(continued...)

# ONE HOLE CLEVIS PINS (cont.)

ZINC PLATED

Line: 300-00



PART NUMBER	SIZE	QTY/BX	LIST PRICE
KMA06104	3/8 X 3 1/4	25	
KMA06112	3/8 X 3 1/2	25	
KMA06120	3/8 X 3 3/4	25	
KMA06128	3/8 X 4	25	
KMA07032	7/16 X 1	25	
KMA07038	7/16 X 1 15/64	25	
KMA07040	7/16 X 1 1/4	25	
KMA07048	7/16 X 1 1/2	25	
KMA07052	7/16 X 1 5/8	25	
KMA07056	7/16 X 1 3/4	25	
KMA07064	7/16 X 2	25	
KMA07072	7/16 X 2 1/4	25	
KMA07076	7/16 X 2 3/8	25	
KMA07080	7/16 X 2 1/2	25	
KMA07084	7/16 X 2 5/8	25	
KMA07088	7/16 X 2 3/4	25	
KMA07096	7/16 X 3	25	
KMA07112	7/16 X 3 1/2	25	
KMA07128	7/16 X 4	25	
KMA08032	1/2 X 1	25	
KMA08040	1/2 X 1 1/4	25	
KMA08044	1/2 X 1 3/8	25	
KMA08046	1/2 X 1 27/64	25	
KMA08048	1/2 X 1 1/2	25	
KMA08056	1/2 X 1 3/4	25	
KMA08064	1/2 X 2	25	
KMA08072	1/2 X 2 1/4	25	
KMA08080	1/2 X 2 1/2	25	
KMA08084	1/2 X 2 5/8	25	
KMA08088	1/2 X 2 3/4	25	
KMA08096	1/2 X 3	25	
KMA08112	1/2 X 3 1/2	25	
KMA08128	1/2 X 4	25	
KMA08144	1/2 X 4 1/2	25	
KMA08160	1/2 X 5	25	
KMA08192	1/2 X 6	25	
KMA09064	9/16 X 2	10	
KMA09080	9/16 X 2 1/2	10	
KMA09096	9/16 X 3	10	
KMA10040	5/8 X 1 1/4	10	
KMA10048	5/8 X 1 1/2	10	
KMA10056	5/8 X 1 3/4	10	
KMA10064	5/8 X 2	10	
KMA10072	5/8 X 2 1/4	10	

(continued...)

## ONE HOLE CLEVIS PINS (cont.)

ZINC PLATED

Line: 300-00



PART NUMBER	SIZE	QTY/BX	LIST PRICE
KMA10080	5/8 X 2 1/2	10	
KMA10096	5/8 X 3	10	
KMA10112	5/8 X 3 1/2	10	
KMA10128	5/8 X 4	10	
KMA12064	3/4 X 2	10	
KMA12080	3/4 X 2 1/2	10	
KMA12088	3/4 X 2 3/4	10	
KMA12096	3/4 X 3	10	
KMA12112	3/4 X 3 1/2	10	
KMA12120	3/4 X 3 3/4	10	
KMA12128	3/4 X 4	10	
KMA12144	3/4 X 4 1/2	10	
KMA12160	3/4 X 5	10	
KMA12208	3/4 X 6 1/2	10	
KMA16112	1 X 3 1/2	5	
KMA16128	1 X 4	5	
KMA20128	1 1/4 X 4	5	
KMA20160	1 1/4 X 5	5	
KMA20192	1 1/4 X 6	5	

## TAPER PIN

PLAIN MACHINED FINISH

Line: 302-00



PART NUMBER	SIZE	QTY/BX	LIST PRICE
DEC70008	7/0 X 1/4 INCH	100	
DEC70016	7/0 X 1/2 INCH	100	
DEC70024	7/0 X 3/4 INCH	100	
DEC70032	7/0 X 1 INCH	100	
DEC70040	7/0 X 1 1/4 INCH	100	
DEC70048	7/0 X 1 1/2 INCH	100	
DEC70056	7/0 X 1 3/4 INCH	100	
DEC70064	7/0 X 2 INCH	100	
DEC70072	7/0 X 2 1/4 INCH	100	
DEC70080	7/0 X 2 1/2 INCH	100	
DEC70088	7/0 X 2 3/4 INCH	100	
DEC70096	7/0 X 3 INCH	100	
DEC60008	6/0 X 1/4 INCH	100	
DEC60016	6/0 X 1/2 INCH	100	
DEC60024	6/0 X 3/4 INCH	100	
DEC60032	6/0 X 1 INCH	100	
DEC60040	6/0 X 1 1/4 INCH	100	
DEC60048	6/0 X 1 1/2 INCH	100	
DEC60056	6/0 X 1 3/4 INCH	100	
DEC60064	6/0 X 2 INCH	100	
DEC60072	6/0 X 2 1/4 INCH	100	

(continued...)

## TAPER PIN (cont.)

PLAIN MACHINED FINISH

Line: 302-00



PART NUMBER	SIZE	QTY/BX	LIST PRICE
DEC60080	6/0 X 2 1/2 INCH	100	
DEC60088	6/0 X 2 3/4 INCH	100	
DEC60096	6/0 X 3 INCH	100	
DEC50008	5/0 X 1/4 INCH	100	
DEC50016	5/0 X 1/2 INCH	100	
DEC50024	5/0 X 3/4 INCH	100	
DEC50032	5/0 X 1 INCH	100	
DEC50040	5/0 X 1 1/4 INCH	100	
DEC50048	5/0 X 1 1/2 INCH	100	
DEC50056	5/0 X 1 3/4 INCH	100	
DEC50064	5/0 X 2 INCH	100	
DEC50072	5/0 X 2 1/4 INCH	100	
DEC50080	5/0 X 2 1/2 INCH	100	
DEC50088	5/0 X 2 3/4 INCH	100	
DEC50096	5/0 X 3 INCH	100	
DEC40008	4/0 X 1/4 INCH	100	
DEC40016	4/0 X 1/2 INCH	100	
DEC40024	4/0 X 3/4 INCH	100	
DEC40032	4/0 X 1 INCH	100	
DEC40040	4/0 X 1 1/4 INCH	100	
DEC40048	4/0 X 1 1/2 INCH	100	
DEC40056	4/0 X 1 3/4 INCH	100	
DEC40064	4/0 X 2 INCH	100	
DEC40072	4/0 X 2 1/4 INCH	100	
DEC40080	4/0 X 2 1/2 INCH	100	
DEC40088	4/0 X 2 3/4 INCH	100	
DEC40096	4/0 X 3 INCH	100	
DEC30016	3/0 X 1/2 INCH	100	
DEC30024	3/0 X 3/4 INCH	100	
DEC30032	3/0 X 1 INCH	100	
DEC30040	3/0 X 1 1/4 INCH	100	
DEC30048	3/0 X 1 1/2 INCH	100	
DEC30056	3/0 X 1 3/4 INCH	100	
DEC30064	3/0 X 2 INCH	100	
DEC30072	3/0 X 2 1/4 INCH	100	
DEC30080	3/0 X 2 1/2 INCH	100	
DEC30088	3/0 X 2 3/4 INCH	100	
DEC30096	3/0 X 3 INCH	100	
DEC20016	2/0 X 1/2 INCH	100	
DEC20020	2/0 X 5/8 INCH	100	
DEC20024	2/0 X 3/4 INCH	100	
DEC20032	2/0 X 1 INCH	100	
DEC20040	2/0 X 1 1/4 INCH	100	
DEC20048	2/0 X 1 1/2 INCH	100	

(continued...)

**TAPER PIN** (continued)

PLAIN MACHINED FINISH

Line: 302-00

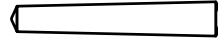

PART NUMBER	SIZE	QTY/BX	LIST PRICE
DEC20056	2/0 X 1 3/4 INCH	100	
DEC20064	2/0 X 2 INCH	100	
DEC20072	2/0 X 2 1/4 INCH	100	
DEC20080	2/0 X 2 1/2 INCH	100	
DEC20088	2/0 X 2 3/4 INCH	100	
DEC20096	2/0 X 3 INCH	100	
DEC00016	0 X 1/2 INCH	100	
DEC00024	0 X 3/4 INCH	100	
DEC00032	0 X 1 INCH	100	
DEC00040	0 X 1 1/4 INCH	100	
DEC00048	0 X 1 1/2 INCH	100	
DEC00056	0 X 1 3/4 INCH	100	
DEC00064	0 X 2 INCH	100	
DEC00072	0 X 2 1/4 INCH	100	
DEC00080	0 X 2 1/2 INCH	100	
DEC00088	0 X 2 3/4 INCH	100	
DEC00096	0 X 3 INCH	100	
DEC00128	0 X 4 INCH	100	
DEC01024	1 X 3/4 INCH	100	
DEC01032	1 X 1 INCH	100	
DEC01040	1 X 1 1/4 INCH	100	
DEC01048	1 X 1 1/2 INCH	100	
DEC01056	1 X 1 3/4 INCH	100	
DEC01064	1 X 2 INCH	100	
DEC01072	1 X 2 1/4 INCH	100	
DEC01080	1 X 2 1/2 INCH	100	
DEC01088	1 X 2 3/4 INCH	100	
DEC01096	1 X 3 INCH	100	
DEC01104	1 X 3 1/4 INCH	100	
DEC01112	1 X 3 1/2 INCH	100	
DEC01120	1 X 3 3/4 INCH	100	
DEC01128X	1 X 4 INCH	100	
DEC02024	2 X 3/4 INCH	100	
DEC02032	2 X 1 INCH	100	
DEC02040	2 X 1 1/4 INCH	100	
DEC02044	2 X 1 3/8 INCH	100	
DEC02048	2 X 1 1/2 INCH	100	
DEC02056	2 X 1 3/4 INCH	100	
DEC02064	2 X 2 INCH	100	
DEC02072	2 X 2 1/4 INCH	100	
DEC02080	2 X 2 1/2 INCH	100	
DEC02088	2 X 2 3/4 INCH	100	
DEC02096	2 X 3 INCH	100	
DEC02104	2 X 3 1/4 INCH	100	

(continued...)

**TAPER PIN** (cont.)

PLAIN MACHINED FINISH

Line: 302-00



PART NUMBER	SIZE	QTY/BX	LIST PRICE
DEC02112	2 X 3 1/2 INCH	100	
DEC02128X	2 X 4 INCH	100	
DEC02144	2 X 4 1/2 INCH	100	
DEC02160X	2 X 5 INCH	100	
DEC03024	3 X 3/4 INCH	100	
DEC03032	3 X 1 INCH	100	
DEC03040	3 X 1 1/4 INCH	100	
DEC03048	3 X 1 1/2 INCH	100	
DEC03056	3 X 1 3/4 INCH	100	
DEC03064	3 X 2 INCH	100	
DEC03072	3 X 2 1/4 INCH	100	
DEC03080	3 X 2 1/2 INCH	100	
DEC03088	3 X 2 3/4 INCH	100	
DEC03096	3 X 3 INCH	100	
DEC03104	3 X 3 1/4 INCH	100	
DEC03112	3 X 3 1/2 INCH	100	
DEC03120X	3 X 3 3/4 INCH	100	
DEC03128	3 X 4 INCH	100	
DEC03144	3 X 4 1/2 INCH	100	
DEC03160	3 X 5 INCH	100	
DEC03192	3 X 6 INCH	100	
DEC04024	4 X 3/4 INCH	100	
DEC04032	4 X 1 INCH	100	
DEC04040	4 X 1 1/4 INCH	100	
DEC04048	4 X 1 1/2 INCH	100	
DEC04056	4 X 1 3/4 INCH	100	
DEC04064	4 X 2 INCH	100	
DEC04072	4 X 2 1/4 INCH	100	
DEC04080	4 X 2 1/2 INCH	100	
DEC04088	4 X 2 3/4 INCH	100	
DEC04096	4 X 3 INCH	100	
DEC04104	4 X 3 1/4 INCH	50	
DEC04112	4 X 3 1/2 INCH	50	
DEC04120	4 X 3 3/4 INCH	50	
DEC04128	4 X 4 INCH	50	
DEC04144X	4 X 4 1/2 INCH	50	
DEC04152	4 X 4 3/4 INCH	50	
DEC04160	4 X 5 INCH	50	
DEC04176	4 X 5 1/2 INCH	50	
DEC04192X	4 X 6 INCH	50	
DEC05024	5 X 3/4 INCH	100	
DEC05032	5 X 1 INCH	100	
DEC05040	5 X 1 1/4 INCH	100	
DEC05048	5 X 1 1/2 INCH	100	

(continued...)

**TAPER PIN (cont.)**

PLAIN MACHINED FINISH

Line: 302-00

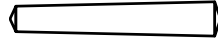

PART NUMBER	SIZE	QTY/BX	LIST PRICE
DEC05056	5 X 1 3/4 INCH	100	
DEC05064	5 X 2 INCH	100	
DEC05072	5 X 2 1/4 INCH	100	
DEC05080	5 X 2 1/2 INCH	100	
DEC05088	5 X 2 3/4 INCH	100	
DEC05096	5 X 3 INCH	100	
DEC05104	5 X 3 1/4 INCH	25	
DEC05112	5 X 3 1/2 INCH	25	
DEC05120	5 X 3 3/4 INCH	25	
DEC05128	5 X 4 INCH	25	
DEC05136	5 X 4 1/4 INCH	25	
DEC05144	5 X 4 1/2 INCH	25	
DEC05152	5 X 4 3/4 INCH	25	
DEC05160	5 X 5 INCH	25	
DEC05176	5 X 5 1/2 INCH	25	
DEC05192	5 X 6 INCH	25	
DEC06024	6 X 3/4 INCH	50	
DEC06032	6 X 1 INCH	50	
DEC06040	6 X 1 1/4 INCH	50	
DEC06048	6 X 1 1/2 INCH	50	
DEC06056	6 X 1 3/4 INCH	50	
DEC06064	6 X 2 INCH	50	
DEC06072	6 X 2 1/4 INCH	50	
DEC06080	6 X 2 1/2 INCH	50	
DEC06088	6 X 2 3/4 INCH	50	
DEC06096	6 X 3 INCH	25	
DEC06104	6 X 3 1/4 INCH	25	
DEC06112	6 X 3 1/2 INCH	25	
DEC06120	6 X 3 3/4 INCH	25	
DEC06128	6 X 4 INCH	25	
DEC06136	6 X 4 1/4 INCH	25	
DEC06144	6 X 4 1/2 INCH	25	
DEC06152	6 X 4 3/4 INCH	25	
DEC06160	6 X 5 INCH	25	
DEC06168	6 X 5 1/4 INCH	25	
DEC06176	6 X 5 1/2 INCH	25	
DEC06184	6 X 5 3/4 INCH	25	
DEC06192	6 X 6 INCH	25	
DEC06208	6 X 6 1/2 INCH	25	
DEC06224	6 X 7 INCH	25	
DEC07032	7 X 1 INCH	25	
DEC07040	7 X 1 1/4 INCH	25	
DEC07048	7 X 1 1/2 INCH	25	
DEC07056	7 X 1 3/4 INCH	25	

(continued...)

**TAPER PIN (cont.)**

PLAIN MACHINED FINISH

Line: 302-00



PART NUMBER	SIZE	QTY/BX	LIST PRICE
DEC07064	7 X 2 INCH	25	
DEC07072	7 X 2 1/4 INCH	25	
DEC07080	7 X 2 1/2 INCH	25	
DEC07088	7 X 2 3/4 INCH	25	
DEC07096	7 X 3 INCH	25	
DEC07104X	7 X 3 1/4 INCH	25	
DEC07112	7 X 3 1/2 INCH	25	
DEC07120	7 X 3 3/4 INCH	25	
DEC07128	7 X 4 INCH	10	
DEC07136	7 X 4 1/4 INCH	10	
DEC07144	7 X 4 1/2 INCH	10	
DEC07152	7 X 4 3/4 INCH	10	
DEC07160	7 X 5 INCH	10	
DEC07168	7 X 5 1/4 INCH	10	
DEC07176	7 X 5 1/2 INCH	10	
DEC07184	7 X 5 3/4 INCH	10	
DEC07192	7 X 6 INCH	10	
DEC07208	7 X 6 1/2 INCH	10	
DEC07224	7 X 7 INCH	10	
DEC08032	8 X 1 INCH	10	
DEC08040	8 X 1 1/4 INCH	10	
DEC08048	8 X 1 1/2 INCH	10	
DEC08056	8 X 1 3/4 INCH	10	
DEC08064	8 X 2 INCH	10	
DEC08072	8 X 2 1/4 INCH	10	
DEC08080	8 X 2 1/2 INCH	10	
DEC08088	8 X 2 3/4 INCH	10	
DEC08096	8 X 3 INCH	10	
DEC08104	8 X 3 1/4 INCH	5	
DEC08112	8 X 3 1/2 INCH	5	
DEC08120	8 X 3 3/4 INCH	5	
DEC08128	8 X 4 INCH	5	
DEC08136	8 X 4 1/4 INCH	5	
DEC08144	8 X 4 1/2 INCH	5	
DEC08152	8 X 4 3/4 INCH	5	
DEC08160	8 X 5 INCH	5	
DEC08168	8 X 5 1/4 INCH	5	
DEC08176	8 X 5 1/2 INCH	5	
DEC08184	8 X 5 3/4 INCH	5	
DEC08192	8 X 6 INCH	5	
DEC08208	8 X 6 1/2 INCH	5	
DEC08224	8 X 7 INCH	5	
DEC09032	9 X 1 INCH	10	
DEC09040	9 X 1 1/4 INCH	10	

(continued...)



**TAPER PIN (cont.)**

PLAIN MACHINED FINISH

Line: 302-00

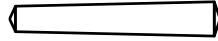

PART NUMBER	SIZE	QTY/BX	LIST PRICE
DEC09048	9 X 1 1/2 INCH	10	
DEC09056	9 X 1 3/4 INCH	10	
DEC09064	9 X 2 INCH	10	
DEC09072	9 X 2 1/4 INCH	10	
DEC09080	9 X 2 1/2 INCH	10	
DEC09088	9 X 2 3/4 INCH	10	
DEC09096	9 X 3 INCH	10	
DEC09104	9 X 3 1/4 INCH	5	
DEC09112	9 X 3 1/2 INCH	5	
DEC09120	9 X 3 3/4 INCH	5	
DEC09128	9 X 4 INCH	5	
DEC09136	9 X 4 1/4 INCH	5	
DEC09144	9 X 4 1/2 INCH	5	
DEC09152	9 X 4 3/4 INCH	5	
DEC09160	9 X 5 INCH	5	
DEC09168	9 X 5 1/4 INCH	5	
DEC09176	9 X 5 1/2 INCH	5	
DEC09184	9 X 5 3/4 INCH	5	
DEC09192	9 X 6 INCH	5	
DEC09208	9 X 6 1/2 INCH	5	
DEC09224	9 X 7 INCH	5	
DEC11032	10 X 1 INCH	5	
DEC11040	10 X 1 1/4 INCH	5	
DEC11048	10 X 1 1/2 INCH	5	
DEC11056	10 X 1 3/4 INCH	5	
DEC11064	10 X 2 INCH	5	
DEC11072	10 X 2 1/4 INCH	5	
DEC11080	10 X 2 1/2 INCH	5	
DEC11088	10 X 2 3/4 INCH	5	
DEC11096	10 X 3 INCH	5	
DEC11104	10 X 3 1/4 INCH	5	
DEC11112	10 X 3 1/2 INCH	5	
DEC11120	10 X 3 3/4 INCH	5	
DEC11128	10 X 4 INCH	5	
DEC11136	10 X 4 1/4 INCH	5	
DEC11144	10 X 4 1/2 INCH	5	
DEC11152	10 X 4 3/4 INCH	5	
DEC11160	10 X 5 INCH	5	
DEC11168	10 X 5 1/4 INCH	5	
DEC11176	10 X 5 1/2 INCH	5	
DEC11184	10 X 5 3/4 INCH	5	
DEC11192	10 X 6 INCH	5	
DEC11208	10 X 6 1/2 INCH	10	
DEC11224	10 X 7 INCH	5	

**RECTANGLE KEY STOCK**

ZINC PLATED

Line: 304-00

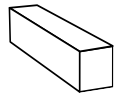

PART NUMBER	SIZE	QTY/BX	LIST PRICE
DHC0302384	3/16 X 1/8 X 12 INCH	5	
DHC0402384	1/4 X 1/8 X 12 INCH	5	
DHC0403384	1/4 X 3/16 X 12 INCH	5	
DHC0503384	5/16 X 3/16 X 12 INCH	5	
DHC0504384	5/16 X 1/4 X 12 INCH	5	
DHC0602384	3/8 X 1/8 X 12 INCH	5	
DHC0603384	3/8 X 3/16 X 12 INCH	5	
DHC0604384	3/8 X 1/4 X 12 INCH	5	
DHC0605384	3/8 X 5/16 X 12 INCH	5	
DHC0710384	7/16 X 5/8 X 12 INCH	1	
DHC0803384	1/2 X 3/16 X 12 INCH	5	
DHC0804384	1/2 X 1/4 X 12 INCH	5	
DHC0805384	1/2 X 5/16 X 12 INCH	5	
DHC0806384	1/2 X 3/8 X 12 INCH	5	
DHC0807384	1/2 X 7/16 X 12 INCH	5	
DHC1005384	5/8 X 5/16 X 12 INCH	1	
DHC1006384	5/8 X 3/8 X 12 INCH	1	
DHC1008384	5/8 X 1/2 X 12 INCH	1	
DHC1206384	3/4 X 3/8 X 12 INCH	1	
DHC1208384	3/4 X 1/2 X 12 INCH	1	
DHC1210384	3/4 X 5/8 X 12 INCH	1	
DHC2018384	1 1/4 X 1 1/8 X 12 INCH	1	
DHC1610384	1 X 5/8 X 12 INCH	1	
DHC1612384	1 X 3/4 X 12 INCH	1	

**SQUARE KEY STOCK**

HARDENED HI-CARBON - PLAIN

Line: 304-01

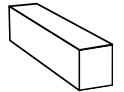

PART NUMBER	SIZE	QTY/BX	LIST PRICE
CAM02384	1/8 X 12 INCH	5	
CAM156384	5/32 X 12 INCH	5	
CAM03384	3/16 X 12 INCH	5	
CAM21384	7/32 X 12 INCH	5	
CAM04384	1/4 X 12 INCH	5	
CAM932384	9/32 X 12 INCH	5	
CAM05384	5/16 X 12 INCH	5	
CAM06384	3/8 X 12 INCH	5	
CAM07384	7/16 X 12 INCH	5	
CAM08384	1/2 X 12 INCH	5	
CAM10384	5/8 X 12 INCH	1	
CAM12384	3/4 X 12 INCH	1	
CAM14384	7/8 X 12 INCH	1	
CAM16384	1 X 12 INCH	1	

## SQUARE KEY STOCK

ZINC PLATED & PLAIN FINISH

Line: 305-00

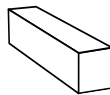

PART NUMBER	SIZE	QTY/BX	LIST PRICE
DJC02PF	1/8 X 1/8 X 12 INCH (PLAIN)	5	
DJC0202384	1/8 X 1/8 X 12 INCH	5	
DJC55PF	5/32 X 5/32 X 12 INCH (PLAIN)	5	
DJC555384X	5/32 X 5/32 X 12 INCH	5	
DJC03PF	3/16 X 3/16 X 12 INCH (PLAIN)	5	
DJC0303384	3/16 X 3/16 X 12 INCH	5	
DJC2121384X	7/32 X 7/32 X 12 INCH	5	
DJC04PF	1/4 X 1/4 X 12 INCH (PLAIN)	5	
DJC0404384	1/4 X 1/4 X 12 INCH	5	
DJC9999384X	9/32 X 9/32 X 12 INCH	5	
DJC05PF	5/16 X 5/16 X 12 INCH (PLAIN)	5	
DJC0505384	5/16 X 5/16 X 12 INCH	5	
DJC06PF	3/8 X 3/8 X 12 INCH (PLAIN)	5	
DJC0606384	3/8 X 3/8 X 12 INCH	5	
DJC07PF	7/16 X 7/16 X 12 INCH (PLAIN)	5	
DJC0707384	7/16 X 7/16 X 12 INCH	5	
DJC08PF	1/2 X 1/2 X 12 INCH (PLAIN)	5	
DJC0808384	1/2 X 1/2 X 12 INCH	5	
DJC0909384	9/16 X 9/16 X 12 INCH	1	
DJC10PF	5/8 X 5/8 X 12 INCH (PLAIN)	1	
DJC1010384	5/8 X 5/8 X 12 INCH	1	
DJC1111384X	11/16 X 11/16 X 12 INCH	1	
DJC12PF	3/4 X 3/4 X 12 INCH (PLAIN)	1	
DJC1212384	3/4 X 3/4 X 12 INCH	1	
DJC1313384X	13/16 X 13/16 X 12 INCH	1	
DJC1414384	7/8 X 7/8 X 12 INCH	1	
DJC16PF	1 X 1 X 12 INCH (PLAIN)	1	
DJC1616384	1 X 1 X 12 INCH	1	
DJC1818384	1 1/8 X 1 1/8 X 12 INCH	1	
DJC2020384X	1 1/4 X 1 1/4 X 12 INCH	1	
DJC2424384	1 1/2 X 1 1/2 X 12 INCH	1	
DJC3232384	2 X 2 X 12 INCH	1	

## SQUARE KEY STOCK

STAINLESS STEEL

Line: 305-02

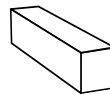

PART NUMBER	SIZE	QTY/BX	LIST PRICE
ARP02SS	1/8 X 12 INCH	5	
ARP03SS	3/16 X 12 INCH	5	
ARP04SS	1/4 X 12 INCH	5	
ARP05SS	5/16 X 12 INCH	5	
ARP06SS	3/8 X 12 INCH	5	
ARP07SS	7/16 X 12 INCH	5	
ARP08SS	1/2 X 12 INCH	5	
ARP10SS	5/8 X 12 INCH	1	

(continued...)

## SQUARE KEY STOCK (cont.)

STAINLESS STEEL

Line: 305-02

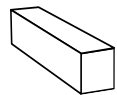

PART NUMBER	SIZE	QTY/BX	LIST PRICE
ARP12SS	3/4 X 12 INCH	1	
ARP14SS	7/8 X 12 INCH	1	
ARP16SS	1 X 12 INCH	1	

## METRIC SQUARE KEY STOCK

STAINLESS STEEL

Line: 305-03

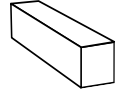

PART NUMBER	SIZE	QTY/BX	LIST PRICE
BSK040412	M4 X 12 INCH	5	
BSK050512	M5 X 12 INCH	5	
BSK060612	M6 X 12 INCH	5	
BSK070712	M7 X 12 INCH	5	
BSK080812	M8 X 12 INCH	5	
BSK101012	M10 X 12 INCH	5	
BSK121212	M12 X 12 INCH	5	
BSK141412	M14 X 12 INCH	1	
BSK161612	M16 X 12 INCH	1	

## METRIC SQUARE KEY STOCK

ZINC PLATED

Line: 305-04

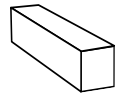

PART NUMBER	SIZE	QTY/BX	LIST PRICE
BTT020212	M2 X 12 INCH	5	
BTT030312	M3 X 12 INCH	5	
BTT040412	M4 X 12 INCH	5	
BTT050512	M5 X 12 INCH	5	
BTT060612	M6 X 12 INCH	5	
BTT070712	M7 X 12 INCH	5	
BTT070812	M7 X M8 X 12 INCH	5	
BTT080812	M8 X 12 INCH	5	
BTT081012	M8 X M10 X 12 INCH	5	
BTT091412	M9 X M14 X 12 INCH	5	
BTT101012	M10 X 12 INCH	5	
BTT121212	M12 X 12 INCH	5	
BTT122012	M12 X M20 X 12 INCH	5	
BTT141412	M14 X 12 INCH	1	
BTT161612	M16 X 12 INCH	1	
BTT181812	M18 X 12 INCH	1	
BTT202012	M20 X 12 INCH	1	
BTT222212	M22 X 12 INCH	1	
BTT252512	M25 X 12 INCH	1	

# WOODRUFF KEY

PLAIN FINISH

Line: 306-00



PART NUMBER	SIZE	QTY/BX	LIST PRICE
DDC02008	1/16 X 1/4 #201	25	
DDC02010	1/16 X 5/16 #206	25	
DDC02012	1/16 X 3/8 #211	25	
DDC02016	1/16 X 1/2 #1	25	
DDC44010	3/32 X 5/16 #207	25	
DDC44012	3/32 X 3/8 #212	25	
DDC44016	3/32 X 1/2 #2	25	
DDC44020	3/32 X 5/8 #4	25	
DDC66012	1/8 X 3/8 #213	25	
DDC66016	1/8 X 1/2 #3	25	
DDC66020	1/8 X 5/8 #5	25	
DDC66020A	1/8 X 5/8 ALLOY	25	
DDC66024	1/8 X 3/4 #7	25	
DDC88020	5/32 X 5/8 #6	25	
DDC88024	5/32 X 3/4 #8	25	
DDC88024A	5/32 X 3/4 ALLOY	25	
DDC88028	5/32 X 7/8 #10	25	
DDC88028A	5/32 X 7/8 ALLOY	25	
DDC03020	3/16 X 5/8 #61	25	
DDC03024	3/16 X 3/4 #9	25	
DDC03028	3/16 X 7/8 #11	25	
DDC03028A	3/16 X 7/8 ALLOY	25	
DDC03032	3/16 X 1 #13	25	
DDC03032A	3/16 X 1 ALLOY	25	
DDC03036	3/16 X 1 1/8 #16	25	
DDC03040	3/16 X 1 1/4 #19	25	
DDC03068	3/16 X 2 1/8 #26	25	
DDC03068A	3/16 X 2 1/8 ALLOY	25	
DDC03068FT	3/16 X 2 1/8 #126	25	
DDC21028	7/32 X 7/8 #12	25	
DDC21032	7/32 X 1 #14	25	
DDC21036	7/32 X 1 1/8 #17	25	
DDC21040	7/32 X 1 1/4 #20	25	
DDC04024	1/4 X 3/4 #91	25	
DDC04028	1/4 X 7/8 #A	25	
DDC04032	1/4 X 1 #15	25	
DDC04032A	1/4 X 1 ALLOY	25	
DDC04032FT	1/4 X 1 #141	25	
DDC04036	1/4 X 1 1/8 #18	25	
DDC04040	1/4 X 1 1/4 #21	25	
DDC04044	1/4 X 1 3/8 #22	25	
DDC04048	1/4 X 1 1/2 #24	25	
DDC04068	1/4 X 2 1/8 #27	25	
DDC04068FT	1/4 X 2 1/8 #127	25	

(continued...)

# WOODRUFF KEY (cont.)

PLAIN FINISH

Line: 306-00



PART NUMBER	SIZE	QTY/BX	LIST PRICE
DDC04088	1/4 X 2 3/4 #R	25	
DDC04088FT	1/4 X 2 3/4 RX	25	
DDC05032	5/16 X 1 #B	25	
DDC05036	5/16 X 1 1/8 #C	25	
DDC05040	5/16 X 1 1/4 #D	25	
DDC05044	5/16 X 1 3/8 #23	25	
DDC05048	5/16 X 1 1/2 #25	25	
DDC05068	5/16 X 2 1/8 #28	25	
DDC05068A	5/16 X 2 1/8 ALLOY	25	
DDC05068FT	5/16 X 2 1/8 #128	25	
DDC05088	5/16 X 2 3/4 #S	25	
DDC05088FT	5/16 X 2 3/4 SX	25	
DDC06032	3/8 X 1 #152	25	
DDC06040	3/8 X 1 1/4 #E	25	
DDC06044	3/8 X 1 3/8 #F	25	
DDC06048	3/8 X 1 1/2 #G	25	
DDC06068	3/8 X 2 1/8 #29	25	
DDC06068FT	3/8 X 2 1/8 #129	25	
DDC06088	3/8 X 2 3/4 #T	25	
DDC06088FT	3/8 X 2 3/4 TX	25	
DDC06112	3/8 X 3 1/2 #30	25	
DDC07088	7/16 X 2 3/4 #U	25	
DDC07088FT	7/16 X 2 3/4 UX	25	
DDC07112	7/16 X 3 1/2 #31	25	
DDC08088	1/2 X 2 3/4 #V	25	
DDC08088FT	1/2 X 2 3/4 VX	25	
DDC08112	1/2 X 3 1/2 #32	25	
DDC09112	9/16 X 3 1/2 #33	25	
DDC10112	5/8 X 3 1/2 #34	25	
DDC11112	11/16 X 3 1/2 #35	25	
DDC12112	3/4 X 3 1/2 #36	25	

## EXTERNAL RETAINING SNAP RINGS

#1400

Line: 308-00



PART NUMBER	SIZE	QTY/BX	LIST PRICE
YUB08	1/8 (12)	25	
YUB10	5/32 (15)	25	
YUB12	3/16 (18)	25	
YUB14	7/32 (21)	25	
YUB15	15/64 (23)	25	
YUB16	1/4 (25)	25	
YUB18	9/32 (28)	25	
YUB20	5/16 (31)	25	
YUB22	11/32 (34)	25	
YUB24	3/8 (37)	25	
YUB26	13/32 (40)	25	
YUB28	7/16 (43)	25	
YUB30	15/32 (46)	25	
YUB32	1/2 (50)	25	
YUB36	9/16 (56)	25	
YUB38	19/32 (59)	25	
YUB40	5/8 (62)	25	
YUB43	43/64 (66)	25	
YUB44	11/16 (68)	25	
YUB48	3/4 (75)	25	
YUB50	25/32 (78)	25	
YUB52	13/16 (81)	25	
YUB56	7/8 (87)	25	
YUB60	15/16 (93)	25	
YUB64	1 (100)	25	
YUB68	1 1/16 (106)	25	
YUB72	1 1/8 (112)	25	
YUB76	1 3/16 (118)	25	
YUB80	1 1/4 (125)	25	
YUB84	1 5/16 (131)	25	
YUB88	1 3/8 (137)	25	
YUB92	1 7/16 (143)	25	
YUB96	1 1/2 (150)	25	
YUB100	1 9/16 (156)	25	
YUB104	1 5/8 (162)	25	
YUB108	1 11/16 (168)	25	
YUB112	1 3/4 (175)	25	
YUB116	1 13/16 (181)	25	
YUB120	1 7/8 (187)	25	
YUB124	1 15/16 (193)	25	
YUB128	2 (200)	25	
YUB132	2 1/16 (206)	25	
YUB136	2 1/8 (212)	25	
YUB138	2 5/32 (215)	25	

(continued...)

## EXTERNAL RETAINING SNAP RINGS (cont.)

#1400

Line: 308-00



PART NUMBER	SIZE	QTY/BX	LIST PRICE
YUB144	2 1/4 (225)	25	
YUB148	2 5/16 (231)	25	
YUB152	2 3/8 (237)	25	
YUB156	2 7/16 (243)	25	
YUB160	2 1/2 (250)	25	
YUB255	2 9/16 (256)	25	
YUB168	2 5/8 (262)	25	
YUB275X	2 3/4 (275)	25	
YUB300X	3 (300)	25	
YUB256	4 (400)	10	

## INTERNAL RETAINING SNAP RING

#1300

Line: 309-00



PART NUMBER	SIZE	QTY/BX	LIST PRICE
YVB16	1/4 (25)	25	
YVB20	5/16 (31)	25	
YVB24	3/8 (37)	25	
YVB28	7/16 (43)	25	
YVB32	1/2 (50)	25	
YVB36	9/16 (56)	25	
YVB40	5/8 (62)	25	
YVB44	11/16 (68)	25	
YVB48	3/4 (75)	25	
YVB52	13/16 (81)	25	
YVB56	7/8 (87)	25	
YVB60	15/16 (93)	25	
YVB64	1 (100)	25	
YVB66	1.023 (1.023)	25	
YVB68	1 1/16 (106)	25	
YVB72	1 1/8 (112)	25	
YVB76	1 3/16 (118)	25	
YVB80	1 1/4 (125)	25	
YVB84	1 5/16 (131)	25	
YVB88	1 3/8 (137)	25	
YVB92	1 7/16 (143)	25	
YVB96	1 1/2 (150)	25	
YVB100	1 9/16 (156)	25	
YVB104	1 5/8 (162)	25	
YVB108	1 11/16 (168)	25	
YVB112	1 3/4 (175)	25	
YVB116	1 13/16 (181)	25	
YVB120	1 7/8 (187)	25	
YVB124	1 15/16 (193)	25	

(continued...)

**INTERNAL RETAINING SNAP RING (cont.)**

#1300

Line: 309-00



PART NUMBER	SIZE	QTY/BX	LIST PRICE
YVB128	2 (200)	25	
YVB132	2 1/16 (206)	25	
YVB136	2 1/8 (212)	25	
YVB140	2 3/16 (218)	25	
YVB144	2 1/4 (225)	25	
YVB148	2 5/16 (231)	25	
YVB152	2 3/8 (237)	25	
YVB244X	2 7/16 (244)	25	
YVB250X	2 1/2 (250)	25	
YVB275X	2 3/4 (275)	25	
YVB300X	3 (300)	25	
YVB315X	80 MM (315)	25	
YVB316X	3 5/32 (315)	25	
YVB277	4 11/32 (433)	25	
YVB500	5 (500)	1	
YVB368	5 3/4 (575)	1	
YVB384	6 (600)	1	
YVB400	6 1/4 (625)	1	

**EXTERNAL C RETAINING SNAP RING**

#1800

Line: 310-00



PART NUMBER	SIZE	QTY/BX	LIST PRICE
YWB08	1/8 (12)	25	
YWB10	5/32 (15)	25	
YWB12	3/16 (18)	25	
YWB14	7/32 (21)	25	
YWB15	15/64 (23)	25	
YWB16	1/4 (25)	25	
YWB18	9/32 (28)	25	
YWB20	5/16 (31)	25	
YWB24	3/8 (37)	25	
YWB26	13/32 (40)	25	
YWB28	7/16 (43)	25	
YWB32	1/2 (50)	25	
YWB36	9/16 (56)	25	
YWB40	5/8 (62)	25	
YWB44	11/16 (68)	25	
YWB48	3/4 (75)	25	
YWB52	13/16 (81)	25	
YWB56	7/8 (87)	25	
YWB60X	15/16 (93)	25	
YWB64	1 (100)	25	
YWB72	1 1/8 (112)	25	

(continued...)

**EXTERNAL C RETAINING SNAP RING (cont.)**

#1800

Line: 310-00



PART NUMBER	SIZE	QTY/BX	LIST PRICE
YWB76	1 3/16 (118)	25	
YWB80	1 1/4 (125)	25	
YWB88	1 3/8 (137)	25	
YWB96	1 1/2 (150)	25	
YWB112	1 3/4 (175)	25	
YWB128	2 (200)	25	

**EXTERNAL E RETAINING SNAP RING**

#1500

Line: 311-00



PART NUMBER	SIZE	QTY/BX	LIST PRICE
YXB04	1/16 (6)	25	
YXB06	3/32 (9)	25	
YXB07	7/64 (X11)	25	
YXB12	3/16 (18)	25	
YXB08	1/8 (12)	25	
YXB14	7/32 (X21)	25	
YXB10	5/32 (15)	25	
YXB16	1/4 (25)	25	
YXB20	5/16 (X31)	25	
YXB09	9/64 (14)	25	
YXB24	3/8 (37)	25	
YXB11	11/64 (X17)	25	
YXB28	7/16 (43)	25	
YXB32	1/2 (50)	25	
YXB40	5/8 (62)	25	
YXB48	3/4 (75)	25	
YXB56	7/8 (87)	25	
YXB64	1 (X98)	25	
YXB76	1 3/16 (X118)	25	
YXB88	1 3/8 (X137)	25	

# METRIC EXTERNAL RETAINING RING

DSH SERIES

Line: 311-25



PART NUMBER	SIZE	QTY/BX	LIST PRICE
CFR30	M3.0	25	
CFR40	M4.0	25	
CFR50	M5.0	25	
CFR60	M6.0	25	
CFR70	M7.0	25	
CFR80	M8.0	25	
CFR90	M9.0	25	
CFR100	M10.0	25	
CFR110	M11.0	25	
CFR120	M12.0	25	
CFR130	M13.0	25	
CFR140	M14.0	25	
CFR150	M15.0	25	
CFR160	M16.0	25	
CFR170	M17.0	25	
CFR180	M18.0	25	
CFR190	M19.0	25	
CFR200	M20.0	25	
CFR210	M21.0	25	
CFR220	M22.0	25	
CFR230	M23.0	25	
CFR240	M24.0	25	
CFR250	M25.0	25	
CFR260	M26.0	25	
CFR270	M27.0	25	
CFR280	M28.0	25	
CFR290	M29.0	25	
CFR300	M30.0	25	
CFR310	M31.0	25	
CFR320	M32.0	25	
CFR330	M33.0	25	
CFR340	M34.0	25	
CFR350	M35.0	25	
CFR360	M36.0	25	
CFR370	M37.0	25	
CFR380	M38.0	25	
CFR390	M39.0	25	
CFR400	M40.0	25	
CFR410	M41.0	25	
CFR420	M42.0	25	
CFR430	M43.0	25	
CFR440	M44.0	25	
CFR450	M45.0	25	
CFR460	M46.0	25	

(continued...)

# METRIC EXTERNAL RETAINING RING (cont.)

DSH SERIES

Line: 311-25



PART NUMBER	SIZE	QTY/BX	LIST PRICE
CFR470	M47.0	25	
CFR480	M48.0	25	
CFR500	M50.0	25	
CFR510	M51.0	25	
CFR520	M52.0	25	
CFR530	M53.0	10	
CFR540	M54.0	10	
CFR550	M55.0	10	
CFR560	M56.0	10	
CFR570	M57.0	10	
CFR580	M58.0	10	
CFR600	M60.0	10	
CFR620	M62.0	10	
CFR630	M63.0	10	
CFR650	M65.0	10	
CFR670	M67.0	10	
CFR680	M68.0	10	
CFR700	M70.0	10	
CFR720	M72.0	5	
CFR750	M75.0	5	
CFR770	M77.0	5	
CFR780	M78.0	5	
CFR800	M80.0	5	
CFR820	M82.0	5	
CFR850	M85.0	5	
CFR870	M87.0	5	
CFR880	M88.0	5	
CFR900	M90.0	5	



**CALL - 1 (800) 723-2826**

**METRIC INTERNAL RETAINING RING**

DHO ROTO SER

Line: 311-26



PART NUMBER	SIZE	QTY/BX	LIST PRICE
CFS80	M8.0	25	
CFS90	M9.0	25	
CFS100	M10.0	25	
CFS110	M11.0	25	
CFS120	M12.0	25	
CFS130	M13.0	25	
CFS140	M14.0	25	
CFS150	M15.0	25	
CFS160	M16.0	25	
CFS170	M17.0	25	
CFS180	M18.0	25	
CFS190	M19.0	25	
CFS200	M20.0	25	
CFS210	M21.0	25	
CFS220	M22.0	25	
CFS230	M23.0	25	
CFS240	M24.0	25	
CFS250	M25.0	25	
CFS260	M26.0	25	
CFS270	M27.0	25	
CFS280	M28.0	25	
CFS290	M29.0	25	
CFS300	M30.0	25	
CFS310	M31.0	25	
CFS320	M32.0	25	
CFS330	M33.0	25	
CFS340	M34.0	25	
CFS350	M35.0	25	
CFS360	M36.0	25	
CFS370	M37.0	25	
CFS380	M38.0	25	
CFS390	M39.0	25	
CFS400	M40.0	25	
CFS410	M41.0	25	
CFS420	M42.0	25	
CFS430	M43.0	25	
CFS440	M44.0	25	
CFS450	M45.0	25	
CFS460	M46.0	25	
CFS470	M47.0	25	
CFS480	M48.0	25	
CFS500	M50.0	25	
CFS510	M51.0	25	
CFS520	M52.0	25	

(continued...)

**METRIC INTERNAL RETAINING RING (cont.)**

DHO ROTO SER

Line: 311-26



PART NUMBER	SIZE	QTY/BX	LIST PRICE
CFS530	M53.0	10	
CFS540	M54.0	10	
CFS550	M55.0	10	
CFS560	M56.0	10	
CFS570	M57.0	10	
CFS580	M58.0	10	
CFS600	M60.0	10	
CFS620	M62.0	10	
CFS630	M63.0	10	
CFS640	M64.0	10	
CFS650	M65.0	10	
CFS670	M67.0	10	
CFS680	M68.0	10	
CFS700	M70.0	10	
CFS720	M72.0	5	
CFS750	M75.0	5	
CFS770	M77.0	5	
CFS780	M78.0	5	
CFS800	M80.0	5	
CFS810	M81.0	5	
CFS820	M82.0	5	
CFS830	M83.0	5	
CFS850	M85.0	5	
CFS870	M87.0	5	
CFS880	M88.0	5	
CFS900	M90.0	5	

## METRIC EXTERNAL RETAINING RING

DE SERIES ROTO

Line: 311-27



PART NUMBER	SIZE	QTY/BX	LIST PRICE
CFT08	0.8 MM	100	
CFT12	1.2 MM	50	
CFT15	1.5 MM	50	
CFT19	1.9 MM	50	
CFT23	2.3 MM	50	
CFT32	3.2 MM	50	
CFT40	4.0 MM	50	
CFT50	5.0 MM	50	
CFT60	6.0 MM	50	
CFT70	7.0 MM	50	
CFT80	8.0 MM	25	
CFT90	9.0 MM	25	
CFT100	10.0 MM	25	
CFT120	12.0 MM	25	
CFT150	15.0 MM	25	
CFT190	19.0 MM	25	
CFT240	24.0 MM	25	

## EXTERNAL RETAINING RING PLIERS

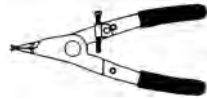

Line: 312-00

PART NUMBER	SIZE	QTY/BX	LIST PRICE
YYBRP18	.18 -.23 RANGE ARP18	1	
YYB2	.37-.87 RANGE RRP200	1	
YYB290	.37 - .87 90° EXT	1	
YYB4	.93-1.43 RANGE RP400	1	
YYB490	.93 - 1.43 90° EXT	1	
YYB6	1.50-3.43 RANGE RP600	1	
YYB690	1.50 - 3.43 90° EXT	1	

## INTERNAL RETAINING RING PLIERS

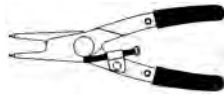

Line: 313-00

PART NUMBER	SIZE	QTY/BX	LIST PRICE
YZBRPS100	.25 -.31 RANGE RPS100	1	
YZB1	.37-1.02 RANGE RP100	1	
YZB190	.37 - 1.02 90° INT	1	
YZB3	1.06-1.75 RANGE RP300	1	
YZB390	1.06 - 1.75 90° INT	1	
YZB5	1.81-3.00 RANGE RP500	1	
YZB590	.81 - 3.47 90° INT	1	

## EXTERNAL RETAINING RING PLIERS

METRIC

Line: 314-01

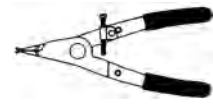

PART NUMBER	SIZE	QTY/BX	LIST PRICE
CFX0310	M3 THRU M10	1	
CFX1025	M10 THRU M25	1	
CFX1960	M19 THRU M60	1	
CFX40100	M40 THRU M100	1	
CFX85165	M85 THRU M165	1	

## INTERNAL RETAINING RING PLIERS

METRIC

Line: 314-02

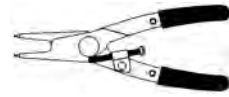

PART NUMBER	SIZE	QTY/BX	LIST PRICE
CFY0310	M3 THRU M10	1	
CFY1025	M10 THRU M25	1	
CFY1960	M19 THRU M60	1	
CFY40100	M40 THRU M100	1	
CFY85165	M85 THRU M165	1	

## HAIRPIN COTTER



Line: 315-00

PART NUMBER	SIZE	QTY/BX	LIST PRICE
ZRB32SSWW	1/16X.042X7/16 SS	100	
ZRB32WW	1/16DIA .042 X 7/16	100	
ZRB26SSWW	7/64X.035X7/16 SS	100	
ZRB26WW	7/64DIA .035 X 7/16	100	
ZRB21WW	1/8DIA .047 X 19/32	100	
ZRB31WW	1/8DIA .028 X 5/8	100	
ZRB23WW	3/16DIA .042 X 1	100	
ZRB13WW	1/4DIA 080 X 1 3/16	100	
ZRB22WW	1/4DIA 062 X 1 5/16	100	
ZRB222WWSS	1/4DIA.062 X 1 5/16	100	
ZRB233WW	1/4 X .093 X 1 1/8	100	
ZRB24WW	1/4DIA 047 X 1 9/16	100	
ZRB28WW	1/4DIA .094 X 2	100	
ZRB3WW	1/4DIA .094 X 1 5/8	100	
ZRB7WW	1/4DIA 094 X 2 5/16	100	
ZRB230WWSS	5/16DIA.102 X 1 1/4	100	
ZRB25WW	5/16DI 072 X 1 3/32	100	
ZRB30WW	5/16DIA 102 X 1 1/4	100	
ZRB14WW	3/8DIA .093 X 2 1/2	100	
ZRB17WW	3/8DIA 080 X 1 9/16	100	
ZRB18WW	3/8DIA 062 X 1 9/16	100	
ZRB239WWSS	3/8DIA .072 X 1 7/8	100	
ZRB11WW	7/16DI 125 X 2 9/16	100	
ZRB15WW	1/2DIA 125 X 1 9/16	100	
ZRB16WW	1/2DI .125 X 1 15/16	100	

(continued...)



## HAIRPIN COTTER (cont.)

Line: 315-00



PART NUMBER	SIZE	QTY/BX	LIST PRICE
ZRB212WW	1/2DIA .162X3 7/16	100	
ZRB10WW	5/8DI 148 X 2 15/16	100	
ZRB27SSWW	5/8 X.125X 2 1/2 SS	100	
ZRB27WW	5/8DIA .125 X 2 1/2	100	
ZRB6WW	5/8DIA .177 X 3 1/4	100	
ZRB19WW	3/4DIA X .243 X 4	50	
ZRB2WW	3/4DIA .125 X 3 1/8	100	
ZRB202WWSS	3/4DIA.125 X 3 1/8	100	
ZRB219WW	3/4 DIA .243 X 4	50	
ZRB29WW	3/4DIA .177 X 3 1/2	100	
ZRB9WW	3/4DIA 148 X 3 5/16	100	
ZRB205WW	7/8DIA .162 X 2 3/16	50	
ZRB220WW	7/8DIA .310X3 15/16	50	
ZRB8WW	7/8DIA .177 X 3 3/4	100	

## HAIRPIN COTTER

LB STYLE

Line: 315-01



PART NUMBER	SIZE	QTY/BX	LIST PRICE
ZRB128	.306 X 4	50	
ZRB19	1/8DIA .029 X 19/32	100	
ZRB30	3/16DI .042 X 15/16	100	
ZRB36	1/4DIA .058 X 1 1/8	100	
ZRB46	5/16DI 072 X 1 7/16	100	
ZRB60	3/8DIA .091 X 1 7/8	100	
ZRB76	1/2DIA .120X 2 3/8	100	
ZRB86	5/8DI 148 X 2 11/16	100	
ZRB106	1DIA .178 X 3 9/16	50	
ZRB168	1 1/4DIA .243 X 5	50	

## HAIRPIN CLIPS

ZINC PLATED

Line: 316-00



PART NUMBER	SIZE	QTY/BX	LIST PRICE
ZSB04	.029 X 1/8	100	
ZSB06	.031 X 3/16	100	
ZSB08	.033 X 1/4	100	
ZSB10	.048 X 5/16	100	
ZSB12	.052 X 3/8	100	
ZSB14	.055 X 7/16	100	
ZSB16	.064 X 1/2	100	
ZSB20	.087 X 5/8	100	
ZSB24	.093 X 3/4	100	
ZSB28	.105 X 7/8	100	
ZSB32	.125 X 1	100	
ZSB4020J	.135 X 11/16 HAIR PI	50	
ZSB2703	3/16 GROOVE X .047	100	
ZSB1548J	1/16 X .026 SHAFT SI	100	
ZSB926J	3/8 GROOVE X .062	100	
ZSB4017J	1/2 GROOVE X .106	100	

## HITCH STEEL PINS

ZINC PLATED

Line: 316-01



PART NUMBER	SIZE	QTY/BX	LIST PRICE
JNF04056CL	1/4 X 1 3/4 COTTERLESS	10	
JNF04080CL	1/4 X 2 1/2 COTTERLESS	10	
JNF08064CLX	1/2 X 2 COTTERLESS	10	
JNF08080X	1/2 X 2 1/2	10	
JNF08152X	1/2 X 4 3/4 31-35	1	
JNF08160X	1/2 X 5	1	
JNF08208	1/2 X 6 1/2	1	
JNF10208X	5/8 X 6 1/2	1	
JNF12152X	3/4 X 4 3/4 #31-13	1	
JNF12224	3/4 X 7 EFF LGT 6.25	1	
JNF14168	7/8 X 5 1/4	1	
JNF14256	7/8 X 8 (EFF 7)	1	
JNF16256X	1 X 8	1	
JNF20248X	1 1/4 X 7 3/4	1	

## SAFETY SNAPPER PIN

ZINC PLATED

Line: 316-02



PART NUMBER	SIZE	QTY/BX	LIST PRICE
JYG091X	.091 X 2 3/4 SAFETY	10	
JYG120X	.120 X 4 3/8 SAFETY	10	
JYG148X	.148 X 5 3/4	10	
JYG2801	1/4 X 2 SNAPPER	5	
JYG2807	1/4 X 2 3/4 SNAPPER	5	
JYG2802	5/16 X 2 3/4 SNPR	5	
JYG2808	5/16 X 2 SNAPPER	5	
JYG2809	5/16 X 3 15/16 SNPR	5	
JYG2803	3/8 X 1 5/8 SNAPPER	5	
JYG2804	3/8 X 2 1/2 SNAPPER	5	
JYG2806	3/8 X 2 3/4 SNAPPER	5	
JYG2811	3/8 X 3 7/16 SNPR	5	
JYG4000H	5/8 X 4	5	

## LYNCH RING PINS

ZINC PLATED

Line: 316-03



PART NUMBER	SIZE	QTY/BX	LIST PRICE
KEA03052X	3/16 X 1 5/8 W/RING	10	
KEA04052	1/4 X 1 5/8 W/RING	10	
KEA05052	5/16 X 1 5/8 W/RING	10	
KEA07052	7/16 X 1 5/8 W/RING	10	
KEA07056	7/16 X 1 3/4 W/RING	10	



CALL - 1 (800) 723-2826

# SECTION 8 PRODUCT INDEX

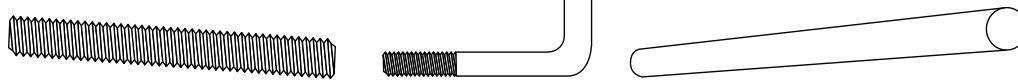

Line Description	Alpha	Line#	Page#
THREADED ROD GRADE 2 - PLAIN FINISH	AKU	318-00	8-2
THREADED ROD GRADE 2 - ZINC PLATED	ALU	319-00	8-2
THREADED ROD GRADE 2 - HOT DIPPED GALVANIZED	ATG	319-01	8-3
THREADED ROD GRADE 2 - B7 ALLOY - PLAIN	AJU	320-00	8-3
L-ANCHOR BOLTS W/NUTS & WASHER - PLAIN	JRF	320-01	8-5
L-ANCHOR BOLTS W/NUTS & WASHER - GALVANIZED	JRF	320-02	8-5
ROUND J-ANCHOR BOLTS A307 STEEL- HD GALVANIZED	CCK	320-03	8-5
ROUND STOCK UNTHREADED STEEL - ZINC	WBB	321-00	8-6
DRILL ROD OIL HARDENING	WDB	322-00	8-6
DRILL ROD WATER HARDENING	WEB	323-00	8-6
B7 - FULL THREAD STUDS - PLAIN	WGB	325-00	8-7

**NOTE:** 12' FOOT ROD **CAN NOT BE SHIPPED** BY UPS OR FED/EX.

COMMON CARRIERS (TRUCK) WILL SHIP AT MINIMUM FREIGHT RATES WHICH MAY NOT BE ECONOMICAL FOR SMALL LOTS.



**CALL - 1 (800) 723-2826**

**THREADED ROD - GRADE 2**

PLAIN FINISH

Line: 318-00



PART NUMBER	SIZE	QTY/BX	LIST PRICE
AKU0403F	1/4-20 X 3'	5	
AKU0503F	5/16-18 X 3'	5	
AKU0603F	3/8-16 X 3'	5	
AKU0703F	7/16-14 X 3'	5	
AKU0803F	1/2-13 X 3'	5	
AKU0903F	9/16-12 X 3'	3	
AKU1003F	5/8-11 X 3'	3	
AKU1203F	3/4-10 X 3'	2	
AKU1403F	7/8-9 X 3'	1	
AKU1603F	1-8 X 3'	1	

**THREADED ROD - GRADE 2**

ZINC PLATED

Line: 319-00



PART NUMBER	SIZE	QTY/BX	LIST PRICE
ALU4403F	4/40 X 3'	5	
ALU5503FX	5/40 X 3'	5	
ALU6603F	6/32 X 3'	5	
ALU6606F	6/32 X 6'	1	
ALU8803F	8/32 X 3'	5	
ALU8806F	8/32 X 6'	1	
ALU0302F	10/24 X 2'	10	
ALU0303F	10/24 X 3'	5	
ALU0306F	10/24 X 6'	1	
ALU50303F	10/32 X 3'	5	
ALU50306F	10/32 X 6'	1	
ALU2103F	12/24 X 3'	5	
ALU0402F	1/4-20 X 2'	10	
ALU0403F	1/4-20 X 3'	5	
ALU0406F	1/4-20 X 6'	1	
ALU0410F	1/4-20 X 10'	1	
ALU0412F	1/4-20 X 12'	1	
ALU50403F	1/4-28 X 3'	3	
ALU50406F	1/4-28 X 6'	1	
ALU0502F	5/16-18 X 2'	10	
ALU0503F	5/16-18 X 3'	5	
ALU0506F	5/16-18 X 6'	1	
ALU0510F	5/16 X 10'	1	
ALU0512F	5/16-18 X 12'	1	
ALU50503F	5/16-24 X 3'	3	
ALU50506F	5/16-24 X 6'	1	
ALU0602F	3/8-16 X 2'	10	
ALU0603F	3/8-16 X 3'	5	
ALU0606F	3/8-16 X 6'	1	

(continued...)

**THREADED ROD - GRADE 2 (cont.)**

ZINC PLATED

Line: 319-00



PART NUMBER	SIZE	QTY/BX	LIST PRICE
ALU0610F	3/8-16 X 10'	1	
ALU0612F	3/8-16 X 12'	1	
ALU50603F	3/8-24 X 3'	3	
ALU50606F	3/8-24 X 6'	1	
ALU0702F	7/16-14 X 2'	5	
ALU0703F	7/16-14 X 3'	5	
ALU0706F	7/16-14 X 6'	1	
ALU50703F	7/16-20 X 3'	1	
ALU50706F	7/16-20 X 6'	1	
ALU0802F	1/2-13 X 2'	5	
ALU0803F	1/2-13 X 3'	5	
ALU0806F	1/2-13 X 6'	1	
ALU0810F	1/2-13 X 10'	1	
ALU0812F	1/2-13 X 12'	1	
ALU50803F	1/2-20 X 3'	1	
ALU50806F	1/2-20 X 6'	1	
ALU0903F	9/16-12 X 3'	3	
ALU0906F	9/16-12 X 6'	1	
ALU50903F	9/16-18 X 3'	1	
ALU50906F	9/16-18 X 6'	1	
ALU1002F	5/8-11 X 2'	3	
ALU1003F	5/8-11 X 3'	3	
ALU1006F	5/8-11 X 6'	1	
ALU1010F	5/8-11 X 10'	1	
ALU1012F	5/8-11 X 12'	1	
ALU51003F	5/8-18 X 3'	1	
ALU51006F	5/8-18 X 6'	1	
ALU1202F	3/4-10 X 2	2	
ALU1203F	3/4-10 X 3'	2	
ALU1206F	3/4-10 X 6'	1	
ALU1210F	3/4-10 X 10'	1	
ALU1212F	3/4-10 X 12'	1	
ALU51203F	3/4-16 X 3'	1	
ALU51206F	3/4-16 X 6'	1	
ALU1403F	7/8-9 X 3'	1	
ALU1406F	7/8-9 X 6'	1	
ALU1410F	7/8-9 X 10'	1	
ALU1412F	7/8-9 X 12'	1	
ALU51403F	7/8-14 X 3'	1	
ALU51406F	7/8-14 X 6'	1	
ALU1603F	1-8 X 3'	1	
ALU1606F	1-8 X 6'	1	
ALU1610F	1-8 X 10'	1	
ALU1612F	1-8 X 12'	1	

(continued...)



**THREADED ROD - GRADE 2 (cont.)**

ZINC PLATED

Line: 319-00

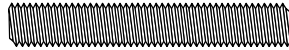

PART NUMBER	SIZE	QTY/BX	LIST PRICE
ALUSS1603F	1-12 X 3'	1	
ALUS1603F	1-14 X 3'	1	
ALUS1606F	1-14 X 6'	1	
ALU1803F	1 1/8-7 X 3'	1	
ALU1806F	1 1/8-7 X 6'	1	
ALU1812F	1 1/8-7 X 12'	1	
ALUS1803F	1 1/8-12 X 3'	1	
ALUS1806F	1 1/8-12 X 6'	1	
ALU2003F	1 1/4-7 X 3'	1	
ALU2006F	1 1/4-7 X 6'	1	
ALU2012F	1 1/4-7 X 12'	1	
ALUS2003F	1 1/4-12 X 3'	1	
ALUS2006F	1 1/4-12 X 6'	1	
ALU2203F	1 3/8-6 X 3'	1	
ALU2206F	1 3/8-6 X 6'	1	
ALU2212F	1 3/8-6 X 12'	1	
ALUS2203F	1 3/8-12 X 3'	1	
ALUS2206F	1 3/8-12 X 6'	1	
ALU2403F	1 1/2-6 X 3'	1	
ALU2406F	1 1/2-6 X 6'	1	
ALU2412F	1 1/2-6 X 12'	1	
ALUS2403F	1 1/2-12 X 3'	1	
ALUS2406F	1 1/2-12 X 6'	1	
ALU2803F	1 3/4-5 X 3'	1	
ALU2806F	1 3/4-5 X 6'	1	
ALU2812F	1 3/4-5 X 12'	1	
ALU3203F	2-4 1/2 X 3'	1	
ALU3206F	2-4 1/2 X 6'	1	
ALU3212F	2-4 1/2 X 12'	1	

**THREADED ROD - GRADE 2**

HOT DIP GALVANIZED

Line: 319-01



PART NUMBER	SIZE	QTY/BX	LIST PRICE
ATG0603F	3/8-16 X 3'	1	
ATG0606F	3/8-16 X 6'	1	
ATG0612F	3/8-16 X 12'	1	
ATG0706F	7/16-14 X 6'	1	
ATG0803F	1/2-13 X 3'	1	
ATG0806F	1/2-13 X 6'	1	
ATG0812F	1/2-13 X 12'	1	
ATG1003F	5/8-11 X 3'	1	
ATG1006F	5/8-11 X 6'	1	

(continued...)

**THREADED ROD - GRADE 2 (cont.)**

HOT DIP GALVANIZED

Line: 319-01

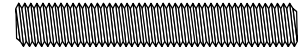

PART NUMBER	SIZE	QTY/BX	LIST PRICE
ATG1012F	5/8-11 X 12'	1	
ATG1203F	3/4-10 X 3'	1	
ATG1206F	3/4-10 X 6'	1	
ATG1212F	3/4-10 X 12'	1	
ATG1403F	7/8-9 X 3'	1	
ATG1406F	7/8-9 X 6'	1	
ATG1412F	7/8-9 X 12'	1	
ATG1603F	1-8 X 3'	1	
ATG1606F	1-8 X 6'	1	
ATG1612F	1-8 X 12'	1	
ATG1803F	1 1/8-7 X 3'	1	
ATG1806F	1 1/8-7 X 6'	1	
ATG2003F	1 1/4-7 X 3'	1	
ATG2006F	1 1/4-7 X 6'	1	
ATG2012F	1 1/4-7 X 12'	1	
ATG2206F	1 3/8-6 X 6'	1	
ATG2403F	1 1/2-6 X 3'	1	
ATG2406F	1 1/2-6 X 6'	1	
ATG2412F	1 1/2-6 X 12'	1	
ATG2803F	1 3/4-5 X 3'	1	
ATG2806F	1 3/4-5 X 6'	1	
ATG2812F	1 3/4-5 X 12'	1	
ATG3203F	2-4 1/2 X 3'	1	
ATG3206F	2-4 1/2 X 6'	1	
ATG3212F	2-4 1/2 X 12'	1	

**THREADED ROD - B7**

ALLOY FINISH/PLAIN

Line: 320-00



PART NUMBER	SIZE	QTY/BX	LIST PRICE
AJU0403F	1/4-20 X 3'	3	
AJU0406F	1/4-20 X 6'	1	
AJU0412F	1/4-20 X 12'	1	
AJUS0403F	1/4-28 X 3'	1	
AJUS0406F	1/4-28 X 6'	1	
AJU0503F	5/16-18 X 3'	3	
AJU0506F	5/16-18 X 6'	1	
AJU0512F	5/16-18 X 12'	1	
AJUS0503F	5/16-24 X 3'	1	
AJUS0506F	5/16-24 X 6'	1	
AJU0603F	3/8-16 X 3'	3	
AJU0606F	3/8-16 X 6'	1	
AJU0612F	3/8-16 X 12'	1	
AJUS0603F	3/8-24 X 3'	1	

(continued...)

**THREADED ROD - B7 (cont.)**

ALLOY FINISH/PLAIN

Line: 320-00



PART NUMBER	SIZE	QTY/BX	LIST PRICE
AJUS0606F	3/8-24 X 6'	1	
AJU0703F	7/16-14 X 3'	1	
AJU0706F	7/16-14 X 6'	1	
AJU0712F	7/16-14 X 12'	1	
AJUS0703F	7/16-20 X 3'	1	
AJUS0706F	7/16-20 X 6'	1	
AJU0803F	1/2-13 X 3'	1	
AJU0806F	1/2-13 X 6'	1	
AJU0812F	1/2-13 X 12'	1	
AJUS0803F	1/2-20 X 3'	1	
AJUS0806F	1/2-20 X 6'	1	
AJU0903F	9/16-12 X 3'	1	
AJU0906F	9/16-12 X 6'	1	
AJU0912F	9/16-12 X 12'	1	
AJUS0903F	9/16-18 X 3'	1	
AJUS0906F	9/16-18 X 6'	1	
AJU1003F	5/8-11 X 3'	1	
AJU1006F	5/8-11 X 6'	1	
AJU1012F	5/8-11 X 12'	1	
AJUS1003F	5/8-18 X 3'	1	
AJUS1006F	5/8-18 X 6'	1	
AJUS1012F	5/8-18 X 12'	1	
AJU1203F	3/4-10 X 3'	1	
AJU1206F	3/4-10 X 6'	1	
AJU1212F	3/4-10 X 12'	1	
AJUS1203F	3/4-16 X 3'	1	
AJUS1206F	3/4-16 X 6'	1	
AJU1403F	7/8-9 X 3'	1	
AJU1406F	7/8-9 X 6'	1	
AJU1412F	7/8-9 X 12'	1	
AJUS1403F	7/8-14 X 3'	1	
AJUS1406F	7/8-14 X 6'	1	
AJU1603F	1-8 X 3'	1	
AJU1606F	1-8 X 6'	1	
AJU1612F	1-8 X 12'	1	
AJUS1603F	1-14 X 3'	1	
AJUS1606F	1-14 X 6'	1	
AJU1803F	1 1/8-7 X 3'	1	
AJU1806F	1 1/8-7 X 6'	1	
AJU1812F	1 1/8-7 X 12'	1	
AJUN1803F	1 1/8-8 X 3'	1	
AJUN1806F	1 1/8-8 X 6'	1	
AJUN1812F	1 1/8-8 X 12'	1	
AJUS1803F	1 1/8-12 X 3'	1	

(continued...)

**THREADED ROD - B7 (cont.)**

ALLOY FINISH

Line: 320-00

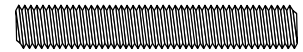

PART NUMBER	SIZE	QTY/BX	LIST PRICE
AJU2003F	1 1/4-7 X 3'	1	
AJU2006F	1 1/4-7 X 6'	1	
AJU2012F	1 1/4-7 X 12'	1	
AJUN2003F	1 1/4-8 X 3'	1	
AJUN2006F	1 1/4-8 X 6'	1	
AJUN2012F	1 1/4-8 X 12'	1	
AJUS2003F	1 1/4-12 X 3'	1	
AJU2203F	1 3/8-6 X 3'	1	
AJU2206F	1 3/8-6 X 6'	1	
AJU2212F	1 3/8-6 X 12'	1	
AJUN2203F	1 3/8-8 X 3'	1	
AJUN2206F	1 3/8-8 X 6'	1	
AJUN2212F	1 3/8-8 X 12'	1	
AJUS2203F	1 3/8-12 X 3'	1	
AJU2403F	1 1/2-6 X 3'	1	
AJU2406F	1 1/2-6 X 6'	1	
AJU2412F	1 1/2-6 X 12'	1	
AJUN2403F	1 1/2-8 X 3'	1	
AJUN2406F	1 1/2-8 X 6'	1	
AJUN2412F	1 1/2-8 X 12'	1	
AJUS2403F	1 1/2-12 X 3'	1	
AJU2603FX	1 5/8-5 X 3'	1	
AJU2803F	1 3/4-5 X 3'	1	
AJU2806F	1 3/4-5 X 6'	1	
AJU2812F	1 3/4-5 X 12'	1	
AJUN2803F	1 3/4-8 X 3'	1	
AJUN2806F	1 3/4-8 X 6'	1	
AJUN2812F	1 3/4-8 X 12'	1	
AJUS2803F	1 3/4-12 X 3'	1	
AJU3203F	2-4 1/2 X 3'	1	
AJU3206F	2-4 1/2 X 6'	1	
AJU3212F	2-4 1/2 X 12'	1	
AJUN3203F	2-8 X 3'	1	
AJUN3206F	2-8 X 6'	1	
AJUN3212F	2-8 X 12'	1	
AJUS3203F	2-12 X 3'	1	
AJUN3603F	2 1/4-8 X 3'	1	

## L/ANCHOR BOLT W/NUTS & WASHERS

PLAIN FINISH

Line: 320-01

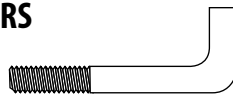

PART NUMBER	SIZE	QTY/BX	LIST PRICE
JRF06192X	3/8 X 6"	50	
JRF06256Q25	3/8 X 8"	25	
JRF06256X	3/8 X 8"	50	
JRF06320	3/8 X 10"	25	
JRF06384	3/8 X 12"	25	
JRF08192	1/2 X 6"	50	
JRF08256	1/2 X 8"	50	
JRF08256Q25	1/2 X 8"	25	
JRF08320	1/2 X 10"	50	
JRF08320Q25	1/2 X 10"	25	
JRF08384	1/2 X 12"	50	
JRF08384Q25	1/2 X 12"	25	
JRF08448	1/2 X 14"	50	
JRF08512	1/2 X 16"	50	
JRF08576	1/2 X 18"	50	
JRF08576Q25	1/2 X 18"	25	
JRF10256	5/8 X 8"	25	
JRF10320	5/8 X 10"	20	
JRF10384	5/8 X 12"	25	
JRF10480	5/8 X 15"	25	
JRF10512	5/8 X 16"	25	
JRF10576	5/8 X 18" (4" THREAD)	25	
JRF12192	3/4 X 6"	25	
JRF12384	3/4 X 12"	20	
JRF12480	3/4 X 15"	20	
JRF12576	3/4 X 18"	20	
JRF12768	3/4 X 24"	20	
JRF12960	3/4 X 30"	20	
JRF14640	7/8 X 20"	20	
JRF16576	1 X 18"	15	
JRF16640	1 X 20"	10	
JRF20576	1 1/4 X 18"	1	

## L/ANCHOR BOLT W/NUTS & WASHERS

HOT DIP GALVANIZED

Line: 320-02

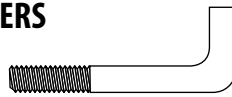

PART NUMBER	SIZE	QTY/BX	LIST PRICE
JRF06192GALV	3/8 X 6"	50	
JRF06256GALV	3/8 X 8"	50	
JRF06320GALV	3/8 X 10"	50	
JRF06384GALV	3/8 X 12"	50	
JRF08192GALV	1/2 X 6"	50	
JRF08256GALV	1/2 X 8"	50	
JRF08320GALV	1/2 X 10"	50	

(continued...)

## L/ANCHOR BOLT W/NUTS & WASHERS (cont.)

HOT DIP GALVANIZED

Line: 320-02

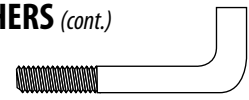

PART NUMBER	SIZE	QTY/BX	LIST PRICE
JRF08384GALV	1/2 X 12"	50	
JRF08512GALV	1/2 X 16"	50	
JRF10320GALV	5/8 X 10"	25	
JRF10384GALV	5/8 X 12"	25	
JRF10512GALV	5/8 X 16"	20	
JRF10576GALV	5/8-11 X 18" (6" THREAD)	25	
JRF12384GALV	3/4 X 12"	20	
JRF12480GALV	3/4 X 15"	20	
JRF12576GALV	3/4 X 18"	20	
JRF12640GALV	3/4 X 20"	20	
JRF16576GALV	1 X 18"	15	

## J/ANCHOR BOLTS

HOT DIP GALVANIZED

Line: 320-03



PART NUMBER	SIZE	QTY/BX	LIST PRICE
CCK06256	3/8 X 8"	50	
CCK06320	3/8 X 10"	50	
CCK06384	3/8 X 12"	50	
CCK06448	3/8 X 14"	25	
CCK08256	1/2 X 8"	50	
CCK08320	1/2 X 10"	50	
CCK08384	1/2 X 12"	50	
CCK08448	1/2 X 14"	25	
CCK08512	1/2 X 16"	25	
CCK08576	1/2 X 18"	25	
CCK10320	5/8 X 10"	25	
CCK10384	5/8 X 12"	25	
CCK10576	5/8 X 18"	15	
CCK12256	3/4 X 8"	25	
CCK12320	3/4 X 10"	25	
CCK12384	3/4 X 12"	25	
CCK16448	1 X 14"	10	

**STEEL ROUND STOCK**

ZINC PLATED

Line: 321-00



PART NUMBER	SIZE	QTY/BX	LIST PRICE
WBB0203F	1/8 X 3'	3	
WBB0303F	3/16 X 3'	3	
WBB0403F	1/4 X 3'	3	
WBB0503F	5/16 X 3'	3	
WBB0603F	3/8 X 3'	3	
WBB0703F	7/16 X 3'	1	
WBB0803F	1/2 X 3'	1	
WBB1003F	5/8 X 3'	1	
WBB1203F	3/4 X 3'	1	
WBB1403F	7/8 X 3'	1	
WBB1603F	1 X 3'	1	
WBB2003F	1 1/4 X 3'	1	

**OIL HARDENING DRILL ROD**

Line: 322-00



PART NUMBER	SIZE	QTY/BX	LIST PRICE
WDB020M3F	M2.0 X 3' (METRIC)	1	
WDB030M3F	M3.0 X 3' (METRIC)	1	
WDB040M3F	M4.0 X 3' (METRIC)	1	
WDB060M3F	M6.0 X 3' (METRIC)	1	
WDB080M3F	M8.0 X 3' (METRIC)	1	
WDB090M3F	M9.0 X 3' (METRIC)	1	
WDB100M3F	M10.0 X 3' (METRIC)	1	
WDB140M3F	M14.0 X 3' (METRIC)	1	
WDB0403F	1/16 X 3'	1	
WDB0503F	5/64 X 3'	1	
WDB0603F	3/32 X 3'	1	
WDB0703F	7/64 X 3'	1	
WDB0803F	1/8 X 3'	1	
WDB0903F	9/64 X 3'	1	
WDB1003F	5/32 X 3'	1	
WDB1103F	11/64 X 3'	1	
WDB1203F	3/16 X 3'	1	
WDB1303F	13/64 X 3'	1	
WDB1403F	7/32 X 3'	1	
WDB1503F	15/64 X 3'	1	
WDB1603F	1/4 X 3'	1	
WDB1703F	17/64 X 3'	1	
WDB1803F	9/32 X 3'	1	
WDB1903F	19/64 X 3'	1	
WDB2003F	5/16 X 3'	1	
WDB2203F	11/32 X 3'	1	
WDB2303F	23/64 X 3'	1	

(continued...)

**OIL HARDENING DRILL ROD (cont.)**

Line: 322-00



PART NUMBER	SIZE	QTY/BX	LIST PRICE
WDB2403F	3/8 X 3'	1	
WDB2503F	25/64 X 3'	1	
WDB2603F	13/32 X 3'	1	
WDB2703F	27/64 X 3'	1	
WDB2803F	7/16 X 3'	1	
WDB2903F	29/64 X 3'	1	
WDB3003F	15/32 X 3'	1	
WDB3103F	31/64 X 3'	1	
WDB3203F	1/2 X 3'	1	
WDB3403F	17/32 X 3'	1	
WDB3603F	9/16 X 3'	1	
WDB3803F	19/32 X 3'	1	
WDB4003F	5/8 X 3'	1	
WDB4203F	21/32 X 3'	1	
WDB4403F	11/16 X 3'	1	
WDB4603F	23/32 X 3'	1	
WDB4803F	3/4 X 3'	1	
WDB5203F	13/16 X 3'	1	
WDB5603F	7/8 X 3'	1	
WDB6003F	15/16 X 3'	1	
WDB6403F	1 X 3'	1	
WDB6803F	1 1/16 X 3'	1	
WDB7203F	1 1/8 X 3'	1	
WDB8003F	1 1/4 X 3'	1	
WDB8403F	1 5/16 X 3'	1	
WDB8803F	1 3/8 X 3'	1	
WDB9603F	1 1/2 X 3'	1	

**WATER HARDENING DRILL ROD**

Line: 323-00



PART NUMBER	SIZE	QTY/BX	LIST PRICE
WEB0403F	1/16 X 3'	1	
WEB0503F	5/64 X 3'	1	
WEB0603F	3/32 X 3'	1	
WEB0703F	7/64 X 3'	1	
WEB0803F	1/8 X 3'	1	
WEB0903F	9/64 X 3'	1	
WEB1003F	5/32 X 3'	1	
WEB1103F	11/64 X 3'	1	
WEB1203F	3/16 X 3'	1	
WEB1303F	13/64 X 3'	1	
WEB1403F	7/32 X 3'	1	
WEB1503F	15/64 X 3'	1	

(continued...)



# WATER HARDENING DRILL ROD (cont.)



Line: 323-00

PART NUMBER	SIZE	QTY/BX	LIST PRICE
WEB1603F	1/4 X 3'	1	
WEB1703F	17/64 X 3'	1	
WEB1803F	9/32 X 3'	1	
WEB1903F	19/64 X 3'	1	
WEB2003F	5/16 X 3'	1	
WEB2203F	11/32 X 3'	1	
WEB2303F	23/64 X 3'	1	
WEB2403F	3/8 X 3'	1	
WEB2503F	25/64 X 3'	1	
WEB2603F	13/32 X 3'	1	
WEB2703F	27/64 X 3'	1	
WEB2803F	7/16 X 3'	1	
WEB2903F	29/64 X 3'	1	
WEB3003F	15/32 X 3'	1	
WEB3103F	31/64 X 3'	1	
WEB3203F	1/2 X 3'	1	
WEB3403F	17/32 X 3'	1	
WEB3603F	9/16 X 3'	1	
WEB3803F	19/32 X 3'	1	
WEB4003F	5/8 X 3'	1	
WEB4203F	21/32 X 3'	1	
WEB4303F	43/64 X 3'	1	
WEB4403F	11/16 X 3'	1	
WEB4603F	23/32 X 3'	1	
WEB4803F	3/4 X 3'	1	
WEB5203F	13/16 X 3'	1	
WEB5603F	7/8 X 3'	1	
WEB6003F	15/16 X 3'	1	
WEB6403F	1 X 3'	1	
WEB6803F	1 1/16 X 3'	1	
WEB7203F	1 1/8 X 3'	1	
WEB8003F	1 1/4 X 3'	1	
WEB8403F	1 5/16 X 3'	1	
WEB8803F	1 3/8 X 3'	1	
WEB9603F	1 1/2 X 3'	1	

# B7 FULL THREAD STUDS

FACTORY AVAILABILITY MAY APPLY

Line: 325-00



PART NUMBER	SIZE	QTY/BX	LIST PRICE
WGB04024X	1/4-20 X 3/4	100	
WGBS04024X	1/4-28 X 3/4	100	
WGB06192	3/8-16 X 6	25	
WGB07072X	7/16-14 X 2 1/4	25	
WGB07128X	7/16-14 X 4	25	
WGB07160	7/16-14 X 5	25	
WGB08064	1/2-13 X 2	25	
WGB08072	1/2-13 X 2 1/4	25	
WGB08080	1/2-13 X 2 1/2	25	
WGB08088	1/2-13 X 2 3/4	25	
WGB08096	1/2-13 X 3	25	
WGB08104	1/2-13 X 3 1/4	25	
WGB08112	1/2-13 X 3 1/2	25	
WGB08120	1/2-13 X 3 3/4	25	
WGB08128	1/2-13 X 4	25	
WGB08136	1/2-13 X 4 1/4	25	
WGB08144	1/2-13 X 4 1/2	25	
WGB08152	1/2-13 X 4 3/4	25	
WGB08160	1/2-13 X 5	25	
WGB08168	1/2-13 X 5 1/4	25	
WGB08176	1/2-13 X 5 1/2	25	
WGB08184	1/2-13 X 5 3/4	25	
WGB08192	1/2-13 X 6	25	
WGB08200	1/2-13 X 6 1/4	25	
WGB08208	1/2-13 X 6 1/2	25	
WGB08216	1/2-13 X 6 3/4	25	
WGB08224	1/2-13 X 7	25	
WGB09080	9/16-12 X 2 1/2	25	
WGB10064	5/8-11 X 2	25	
WGB10072	5/8-11 X 2 1/4	25	
WGB10080	5/8-11 X 2 1/2	25	
WGB10088	5/8-11 X 2 3/4	25	
WGB10096	5/8-11 X 3	25	
WGB10104	5/8-11 X 3 1/4	25	
WGB10112	5/8-11 X 3 1/2	25	
WGB10120	5/8-11 X 3 3/4	25	
WGB10128	5/8-11 X 4	25	
WGB10136	5/8-11 X 4 1/4	25	
WGB10144	5/8-11 X 4 1/2	25	
WGB10152	5/8-11 X 4 3/4	25	
WGB10160	5/8-11 X 5	25	
WGB10168	5/8-11 X 5 1/4	25	
WGB10176	5/8-11 X 5 1/2	25	
WGB10184	5/8-11 X 5 3/4	25	

(continued...)

**B7 FULL THREAD STUDS (cont.)**

FACTORY AVAILABILITY MAY APPLY

Line: 325-00

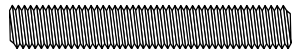

PART NUMBER	SIZE	QTY/BX	LIST PRICE
WGB10192	5/8-11 X 6	25	
WGB10200	5/8-11 X 6 1/4	25	
WGB10208	5/8-11 X 6 1/2	25	
WGB10224	5/8-11 X 7	25	
WGB10232X	5/8-11 X 7 1/4	25	
WGB10240	5/8-11 X 7 1/2	25	
WGB10256	5/8-11 X 8	25	
WGB10336	5/8-11 X 10 1/2	25	
WGB12064	3/4-10 X 2	25	
WGB12072	3/4-10 X 2 1/4	25	
WGB12080	3/4-10 X 2 1/2	25	
WGB12088	3/4-10 X 2 3/4	25	
WGB12096	3/4-10 X 3	25	
WGB12104	3/4-10 X 3 1/4	25	
WGB12112	3/4-10 X 3 1/2	25	
WGB12120	3/4-10 X 3 3/4	25	
WGB12128	3/4-10 X 4	25	
WGB12136	3/4-10 X 4 1/4	25	
WGB12144	3/4-10 X 4 1/2	25	
WGB12152	3/4-10 X 4 3/4	25	
WGB12160	3/4-10 X 5	25	
WGB12168	3/4-10 X 5 1/4	25	
WGB12176	3/4-10 X 5 1/2	25	
WGB12184	3/4-10 X 5 3/4	25	
WGB12192	3/4-10 X 6	25	
WGB12200	3/4-10 X 6 1/4	25	
WGB12208	3/4-10 X 6 1/2	25	
WGB12224	3/4-10 X 7	25	
WGB12232	3/4-10 X 7 1/4	25	
WGB12240	3/4-10 X 7 1/2	25	
WGB12256	3/4-10 X 8	25	
WGB12272	3/4-10 X 8 1/2	25	
WGB12288	3/4-10 X 9	25	
WGB12320	3/4-10 X 10	25	
WGB14096	7/8-9 X 3	10	
WGB14104	7/8-9 X 3 1/4	10	
WGB14112	7/8-9 X 3 1/2	10	
WGB14120	7/8-9 X 3 3/4	10	
WGB14128	7/8-9 X 4	10	
WGB14136	7/8-9 X 4 1/4	10	
WGB14144	7/8-9 X 4 1/2	10	
WGB14152	7/8-9 X 4 3/4	10	
WGB14160	7/8-9 X 5	10	

(continued...)

**B7 FULL THREAD STUDS (cont.)**

FACTORY AVAILABILITY MAY APPLY

Line: 325-00

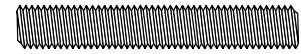

PART NUMBER	SIZE	QTY/BX	LIST PRICE
WGB14168	7/8-9 X 5 1/4	10	
WGB14176	7/8-9 X 5 1/2	10	
WGB14184	7/8-9 X 5 3/4	10	
WGB14192	7/8-9 X 6	10	
WGB14200	7/8-9 X 6 1/4	10	
WGB14208	7/8-9 X 6 1/2	10	
WGB14224	7/8-9 X 7	10	
WGB14232	7/8-9 X 7 1/4	1	
WGB14240	7/8-9 X 7 1/2	1	
WGB14248	7/8-9 X 7 3/4	1	
WGB14256	7/8-9 X 8	1	
WGB14264	7/8-9 X 8 1/4	1	
WGB14272	7/8-9 X 8 1/2	1	
WGB14288	7/8-9 X 9	1	
WGB14304	7/8-9 X 9 1/2	1	
WGB14320	7/8-9 X 10	1	
WGB14352	7/8-9 X 11	1	
WGB16128	1-8 X 4	10	
WGB16136	1-8 X 4 1/4	10	
WGB16144	1-8 X 4 1/2	10	
WGB16152	1-8 X 4 3/4	10	
WGB16160	1-8 X 5	10	
WGB16168	1-8 X 5 1/4	10	
WGB16176	1-8 X 5 1/2	10	
WGB16184	1-8 X 5 3/4	10	
WGB16192	1-8 X 6	10	
WGB16200	1-8 X 6 1/4	10	
WGB16208	1-8 X 6 1/2	10	
WGB16216	1-8 X 6 3/4	10	
WGB16224	1-8 X 7	10	
WGB16232	1-8 X 7 1/4	10	
WGB16240	1-8 X 7 1/2	10	
WGB16248X	1-8 X 7 3/4	10	
WGB16256	1-8 X 8	10	
WGB16264	1-8 X 8 1/4	10	
WGB16272	1-8 X 8 1/2	10	
WGB16288	1-8 X 9	10	
WGB16320	1-8 X 10	10	
WGB16384	1-8 X 12	10	
WGB18096X	1 1/8-7 X 3	1	
WGB18120	1 1/8-7 X 3 3/4	1	
WGB18144	1 1/8-7 X 4 1/2	1	
WGB18160	1 1/8-7 X 5	1	

(continued...)

**B7 FULL THREAD STUDS (cont.)**

FACTORY AVAILABILITY MAY APPLY

Line: 325-00



PART NUMBER	SIZE	QTY/BX	LIST PRICE
WGB18176	1 1/8-7 X 5 1/2	1	
WGB18192	1 1/8-7 X 6	1	
WGB18200	1 1/8-7 X 6 1/4	1	
WGB18208	1 1/8-7 X 6 1/2	1	
WGB18216	1 1/8-7 X 6 3/4	1	
WGB18224	1 1/8-7 X 7	1	
WGB18240	1 1/8-7 X 7 1/2	1	
WGB18248	1 1/8-7 X 7 3/4	1	
WGB18256	1 1/8-7 X 8	1	
WGB18264	1 1/8-7 X 8 1/4	1	
WGB18272	1 1/8-7 X 8 1/2	1	
WGB18288	1 1/8-7 X 9	1	
WGB18320	1 1/8-7 X 10	1	
WGB18352	1 1/8-7 X 11	1	
WGB18384	1 1/8-7 X 12	1	
WGBS18160	1 1/8-8 X 5	1	
WGBS18176	1 1/8-8 X 5 1/2	1	
WGBS18192	1 1/8-8 X 6	1	
WGBS18200	1 1/8-8 X 6 1/4	1	
WGBS18208	1 1/8-8 X 6 1/2	1	
WGBS18216	1 1/8-8 X 6 3/4	1	
WGBS18224	1 1/8-8 X 7	1	
WGBS18240	1 1/8-8 X 7 1/2	1	
WGBS18256	1 1/8-8 X 8	1	
WGBS18264	1 1/8-8 X 8 1/4	1	
WGBS18272	1 1/8-8 X 8 1/2	1	
WGBS18288	1 1/8-8 X 9	1	
WGBS18320	1 1/8-8 X 10	1	
WGBS18352	1 1/8-8 X 11	1	
WGBS18384	1 1/8-8 X 12	1	
WGB20144	1 1/4-7 X 4 1/2	1	
WGB20192	1 1/4-7 X 6	1	
WGB20200	1 1/4-7 X 6 1/4	1	
WGB20208	1 1/4-7 X 6 1/2	1	
WGB20216	1 1/4-7 X 6 3/4	1	
WGB20224	1 1/4-7 X 7	1	
WGB20240	1 1/4-7 X 7 1/2	1	
WGB20256	1 1/4-7 X 8	1	
WGB20272	1 1/4-7 X 8 1/2	1	
WGB20288	1 1/4-7 X 9	1	
WGB20320	1 1/4-7 X 10	1	
WGB20352	1 1/4-7 X 11	1	
WGB20384	1 1/4-7 X 12	1	
WGBS20160	1 1/4-8 X 5	1	

(continued...)

**B7 FULL THREAD STUDS (cont.)**

FACTORY AVAILABILITY MAY APPLY

Line: 325-00



PART NUMBER	SIZE	QTY/BX	LIST PRICE
WGBS20176	1 1/4-8 X 5 1/2	1	
WGBS20192	1 1/4-8 X 6	1	
WGBS20200	1 1/4-8 X 6 1/4	1	
WGBS20208	1 1/4-8 X 6 1/2	1	
WGBS20216	1 1/4-8 X 6 3/4	1	
WGBS20224	1 1/4-8 X 7	1	
WGBS20240	1 1/4-8 X 7 1/2	1	
WGBS20256	1 1/4-8 X 8	1	
WGBS20272	1 1/4-8 X 8 1/2	1	
WGBS20288	1 1/4-8 X 9	1	
WGBS20320	1 1/4-8 X 10	1	
WGBS20352	1 1/4-8 X 11	1	
WGBS20384	1 1/4-8 X 12	1	

# SECTION 9 PRODUCT INDEX

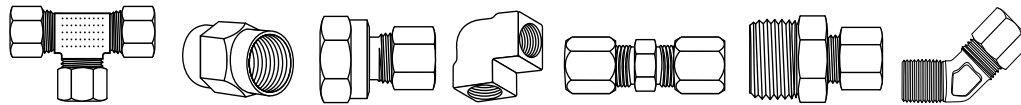

Line Description	Alpha	Line#	Page#
SAE FLARE SHORT NUT BRASS TUBE FITTING - PARKER/DANA	LFA	326-00	9-11
SAE FLARE LONG NUT BRASS TUBE FITTING - PARKER/DANA	LGA	327-00	9-11
SAE FLARE UNION NUT BRASS TUBE FITTING - PARKER/DANA	LJA	328-00	9-11
SAE FLARE 3/WAY TEE BRASS TUBE FITTING - PARKER/DANA	LKA	329-00	9-11
SAE FLARE CAP BRASS TUBE FITTING - PARKER/DANA	LLA	330-00	9-11
SAE FLARE PLUG BRASS TUBE FITTING - PARKER/DANA	LMA	331-00	9-11
SAE FLARE REFER NUT BRASS TUBE FITTING - PARKER/DANA	LNA	332-00	9-11
SAE FLARE SWIVEL UNION BRASS TUBE FITTING - PARKER/DANA	LNAU	333-00	9-11
SAE FLARE UNION ELBOW BRASS TUBE FITTING - PARKER/DANA	LSA	335-00	9-12
SAE FLARE BONNET BRASS TUBE FITTING - PARKER/DANA	LTA	336-00	9-12
SAE FLARE COPPER GASKET BRASS TUBE FITTING - PARKER/DANA	LUA	336-01	9-12
SAE FLARE MALE CONNECTOR BRASS TUBE FITTING - PARKER/DANA	LWA	337-00	9-12
SAE FLARE MALE ELBOW BRASS TUBE FITTING - PARKER/DANA	LXA	338-00	9-12
SAE FLARE FEMALE ELBOW BRASS TUBE FITTING - PARKER/DANA	LYA	339-00	9-13
SAE FLARE FEMALE CONNECTOR BRASS TUBE FITTING - PARKER/DANA	LZA	340-00	9-13
SAE FLARE 45° MALE ELBOW BRASS TUBE FITTING - PARKER/DANA	MAA	341-00	9-13
SAE FLARE RED UNION BRASS TUBE FITTING - PARKER/DANA	MBA	342-00	9-13
SAE FLARE MALE X FEMALE BRASS TUBE FITTING - PARKER/DANA	MCA	343-00	9-13
SAE FLARE 2/WAY BRANCH TEE BRASS TUBE FITTING - PARKER/DANA	MEA	345-00	9-14
SAE FLARE 2/WAY RUN TEE BRASS TUBE FITTING - PARKER/DANA	MFA	346-00	9-14
SAE FLARE ADAPT TEE BRASS TUBE FITTING - PARKER/DANA	MHA	347-00	9-14
SAE FLARE CHECK FLOW MALE CONN BRASS TUBE FITTING - PARKER/DANA	MJA	348-00	9-14
COMPRESSION SHORT NUT BRASS TUBE FITTING - PARKER/DANA	MKA	349-00	9-14
COMPRESSION LONG NUT BRASS TUBE FITTING - PARKER/DANA	MLA	350-00	9-14
COMPRESSION SLEEVE BRASS TUBE FITTING - PARKER/DANA	MMA	351-00	9-14
COMPRESSION NYLON SLEEVE BRASS TUBE FITTING - PARKER/DANA	NKA	351-02	9-15
COMPRESSION TUBE INSERTS FOR POLY TUBING - PARKER/DANA	NLA	351-03	9-15
COMPRESSION UNION BRASS TUBE FITTINGS - PARKER/DANA	MNA	352-00	9-15
COMPRESSION UNION ELBOW BRASS TUBE FITTINGS - PARKER/DANA	MPA	353-00	9-15
COMPRESSION 3/WAY UNION TEE BRASS TUBE FITTING - PARKER/DANA	MRA	354-00	9-15
COMPRESSION BULK HD UNION BRASS TUBE FITTINGS - PARKER/DANA	MSA	355-00	9-15
COMPRESSION MALE CONN BRASS TUBE FITTINGS - PARKER/DANA	MTA	356-00	9-16
COMPRESSION MALE ELBOW BRASS TUBE FITTINGS - PARKER/DANA	MUA	357-00	9-16

(CONTINUED...)



**CALL - 1 (800) 723-2826**

# SECTION 9 PRODUCT INDEX

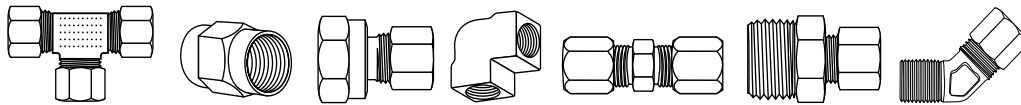

<b>Line Description</b>	<b>Alpha</b>	<b>Line#</b>	<b>Page#</b>
COMPRESSION FEMALE CONN BRASS TUBE FITTINGS - PARKER/DANA	<b>MVA</b>	<b>358-00</b>	9-16
COMPRESSION FEMALE ELBOW BRASS TUBE FITTINGS - PARKER/DANA	<b>MWA</b>	<b>359-00</b>	9-17
COMPRESSION 45° MALE ELBOW BRASS TUBE FITTINGS - PARKER/DANA	<b>MXA</b>	<b>360-00</b>	9-17
COMPRESSION 2/WAY BRANCH TEE BRASS TUBE FITTING- PARKER/DANA	<b>MYA</b>	<b>361-00</b>	9-17
COMPRESSION 2/WAY RUN TEE BRASS TUBE FITTINGS- PARKER/DANA	<b>MZA</b>	<b>362-00</b>	9-17
COMPRESSION ADAPT TEE BRASS TUBE FITTINGS- PARKER/DANA	<b>NAA</b>	<b>363-00</b>	9-17
COMPRESSION REDUCING UNION BRASS TUBE FITTINGS- PARKER/DANA	<b>NBA</b>	<b>364-00</b>	9-17
COMPRESSION CHECK MALE CONN BRASS TUBE FITTING- PARKER/DANA	<b>NCA</b>	<b>365-00</b>	9-18
SELF ALIGN SLV/NUT ASSEMBLY - BRASS TUBE FITT - PARKER/DANA	<b>CBV</b>	<b>365-99</b>	9-18
SELF ALIGN SLEEVES - BRASS TUBE FITTINGS - PARKER/DANA	<b>HTD</b>	<b>366-00</b>	9-18
SELF ALIGN SHORT NUT - BRASS TUBE FITTINGS - PARKER/DANA	<b>HUD</b>	<b>366-01</b>	9-18
SELF ALIGN UNION - BRASS TUBE FITTINGS - PARKER/DANA	<b>JUV</b>	<b>366-03</b>	9-18
SELF ALIGN MALE CONN - BRASS TUBE FITTINGS - PARKER/DANA	<b>JVV</b>	<b>366-04</b>	9-18
SELF ALIGN MALE ELBOW - BRASS TUBE FITTINGS - PARKER/DANA	<b>JWV</b>	<b>366-05</b>	9-19
SELF ALIGN UNION ELBOW - BRASS TUBE FITTINGS - PARKER/DANA	<b>JXV</b>	<b>366-06</b>	9-19
SELF ALIGN FEMALE CONN - BRASS TUBE FITTINGS - PARKER/DANA	<b>JYV</b>	<b>366-07</b>	9-19
SELF ALIGN FEMALE ELBOW - BRASS TUBE FITTINGS - PARKER/DANA	<b>JZV</b>	<b>366-08</b>	9-19
SELF ALIGN UNION TEE - BRASS TUBE FITTINGS - PARKER/DANA	<b>JAW</b>	<b>366-09</b>	9-19
SELF ALIGN MALE RUN TEE - BRASS TUBE FITTINGS - PARKER/DANA	<b>JBW</b>	<b>366-10</b>	9-19
SELF ALIGN MALE BRANCH TEE - BRASS TUBE FITTINGS - PARKER/DANA	<b>JCW</b>	<b>366-11</b>	9-19
VIBRA LOCK RUBBER SLEEVES - PARKER	<b>JXX</b>	<b>367-12</b>	9-20
AIR BRAKE LONG NUT BRASS TUBE FITTINGS - PARKER/DANA	<b>NFA</b>	<b>368-00</b>	9-20
AIR BRAKE SLEEVE BRASS TUBE FITTINGS - PARKER/DANA	<b>NEA</b>	<b>369-00</b>	9-20
AIR BRAKE LONG UNION BRASS TUBE FITTINGS - PARKER/DANA	<b>NGA</b>	<b>370-00</b>	9-20
AIR BRAKE 3/WAY UNION TEE BRASS TUBE FITTINGS - PARKER/DANA	<b>NHA</b>	<b>371-00</b>	9-20
AIR BRAKE UNION ELBOW BRASS TUBE FITTINGS - PARKER/DANA	<b>NJA</b>	<b>372-00</b>	9-20
AIR BRAKE MALE CONNECTOR BRASS TUBE FITTINGS - PARKER/DANA	<b>NMA</b>	<b>375-00</b>	9-20
AIR BRAKE MALE ELBOW BRASS TUBE FITTINGS - PARKER/DANA	<b>NNA</b>	<b>376-00</b>	9-21
AIR BRAKE FEMALE CONNECTOR BRASS TUBE FITTINGS - PARKER/DANA	<b>NPA</b>	<b>377-00</b>	9-21
AIR BRAKE FEMALE ELBOW BRASS TUBE FITTINGS - PARKER/DANA	<b>NRA</b>	<b>378-00</b>	9-21
AIR BRAKE 45° MALE ELBOW BRASS TUBE FITTINGS - PARKER/DANA	<b>NSA</b>	<b>379-00</b>	9-21
AIR BRAKE 2/WAY BRANCH TEE BRASS TUBE FITTINGS - PARKER/DANA	<b>NTA</b>	<b>380-00</b>	9-21
AIR BRAKE 2/WAY RUN TEE BRASS TUBE FITTINGS - PARKER/DANA	<b>NUA</b>	<b>381-00</b>	9-21

(CONTINUED...)



**CALL - 1 (800) 723-2826**

# SECTION 9 PRODUCT INDEX

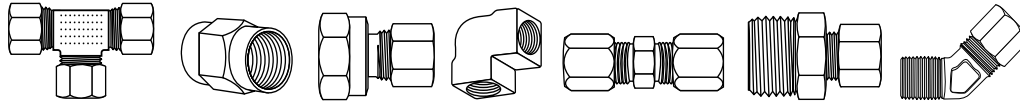

Line Description	Alpha	Line#	Page#
PIPE THREAD BULKHEAD COUPLINGS - STEEL & BRASS - DANA	<b>NYA</b>	<b>384-00</b>	9-22
AIR COCK DRAINS - BRASS - PARKER	<b>NZA</b>	<b>385-00</b>	9-22
AIR BRAKE HOSE BODY CONNECTOR W/NUT - PARKER	<b>PAA</b>	<b>385-02</b>	9-22
AIR BRAKE HOSE BODY CONNECTOR W/SPRING NUT - PARKER	<b>PAA</b>	<b>385-03</b>	9-22
AIR BRAKE HOSE BODY (ONLY) BRASS - PARKER	<b>PAA</b>	<b>386-00</b>	9-22
AIR BRAKE GLAD HAND COUPLER - DANA	<b>WEA</b>	<b>386-02</b>	9-22
AIR BRAKE GLAD HAND SEAL - DANA	<b>WEA</b>	<b>386-03</b>	9-22
AIR BRAKE H338 TRUCK HOSE CONN W/ADAPT - PARKER/DANA	<b>WEA</b>	<b>386-04</b>	9-22
AIR BRAKE H338 TRUCK HOSE CONNECTOR - PARKER/DANA	<b>WEA</b>	<b>386-05</b>	9-22
AIR BRAKE H338 ADAPTER - PARKER/DANA	<b>WEA</b>	<b>386-08</b>	9-22
AIR BRAKE TRUCK HOSE SLEEVE BRASS	<b>PBA</b>	<b>387-00</b>	9-22
AIR BRAKE TRUCK HOSE NUT BRASS - PARKER/DANA	<b>PCA</b>	<b>388-00</b>	9-23
AIR BRAKE TRUCK HOSE SPRINGNUT PARTS BRASS - PARKER/DANA	<b>PDA</b>	<b>389-00</b>	9-23
AIR BRAKE HOSE SPRINGNUT PARTS BRASS - PARKER/DANA	<b>PDA</b>	<b>389-01</b>	9-23
AIR BRAKE TRUCK HOSE MENDERS BRASS - PARKER/DANA	<b>PEA</b>	<b>390-00</b>	9-23
J844 TRUCK TUBING SLEEVE BRASS - PARKER/DANA	<b>PFA</b>	<b>391-00</b>	9-23
J844 TRUCK TUBING NUT BRASS - PARKER/DANA	<b>PGA</b>	<b>392-00</b>	9-23
J844 TRUCK TUBING UNION BRASS - PARKER/DANA	<b>PHA</b>	<b>393-00</b>	9-23
J844 TRUCK TUBING UNION ELBOW BRASS - PARKER/DANA	<b>PJA</b>	<b>394-00</b>	9-23
J844 BULK HEAD UNION BRASS - PARKER/DANA	<b>PKA</b>	<b>395-00</b>	9-23
J844 TRUCK TUBING INSERTS - BRASS - PARKER/DANA	<b>PLA</b>	<b>396-00</b>	9-23
J844 TRUCK TUBING UNION TEE - BRASS - PARKER/DANA	<b>PMA</b>	<b>397-00</b>	9-24
J844 TRUCK TUBING FEMALE CONNECTOR - BRASS - PARKER/DANA	<b>PNA</b>	<b>398-00</b>	9-24
J844 TRUCK TUBING FEMALE ELBOW - BRASS - PARKER/DANA	<b>PPA</b>	<b>399-00</b>	9-24
J844 TRUCK TUBING MALE RUN TEE - BRASS - PARKER/DANA	<b>PRA</b>	<b>400-00</b>	9-24
J844 TRUCK TUBING FEMALE BRANCH TEE - BRASS - PARKER/DANA	<b>PSA</b>	<b>401-00</b>	9-24
J844 TRUCK TUBING ADAPTER TEE - BRASS - PARKER/DANA	<b>PTA</b>	<b>402-00</b>	9-24
J844 TRUCK TUBING MALE BRANCH TEE - BRASS - PARKER/DANA	<b>PVA</b>	<b>404-00</b>	9-24
J844 TRUCK TUBING MALE CONNECTOR - BRASS - PARKER/DANA	<b>PWA</b>	<b>405-00</b>	9-25
J844 TRUCK TUBING MALE ELBOW - BRASS - PARKER/DANA	<b>PXA</b>	<b>406-00</b>	9-25
J844 TRUCK TUBING 45° MALE ELBOW - BRASS - PARKER/DANA	<b>PYA</b>	<b>407-00</b>	9-25
INVERTED FLARE NUT BRASS - PARKER/DANA	<b>PZA</b>	<b>408-00</b>	9-25
INVERTED FLARE NUT STEEL- PARKER/DANA	<b>RAA</b>	<b>409-00</b>	9-25
INVERTED FLARE LONG NUT STEEL- PARKER/DANA	<b>RBA</b>	<b>410-00</b>	9-26
INVERTED FLARE UNION BRASS - PARKER/DANA	<b>RCA</b>	<b>411-00</b>	9-26
INVERTED FLARE UNION ELBOW BRASS - PARKER/DANA	<b>RDA</b>	<b>412-00</b>	9-26
INVERTED FLARE UNION TEE - BRASS - PARKER/DANA	<b>REA</b>	<b>413-00</b>	9-26
INVERTED FLARE PLUG - STEEL- PARKER/DANA	<b>RFA</b>	<b>414-00</b>	9-26
INVERTED FLARE MALE CONNECTOR - BRASS - PARKER/DANA	<b>RGA</b>	<b>415-00</b>	9-26
INVERTED FLARE MALE ELBOW - BRASS - PARKER/DANA	<b>RHA</b>	<b>416-00</b>	9-26

(CONTINUED...)

# SECTION 9 PRODUCT INDEX

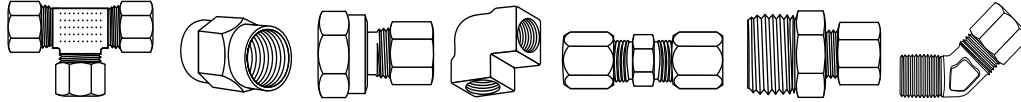

<b>Line Description</b>	<b>Alpha</b>	<b>Line#</b>	<b>Page#</b>
INVERTED FLARE FEMALE CONNECTOR - BRASS - PARKER/DANA	<b>RJA</b>	<b>417-00</b>	9-27
INVERTED FLARE 45° MALE ELBOW - BRASS - PARKER/DANA	<b>RKA</b>	<b>418-00</b>	9-27
INVERTED FLARE FEMALE ELBOW - BRASS - PARKER/DANA	<b>RLA</b>	<b>419-00</b>	9-27
INVERTED FLARE MALE BRANCH TEE - BRASS - PARKER/DANA	<b>RMA</b>	<b>420-00</b>	9-27
INVERTED FLARE FEMALE BRANCH TEE - BRASS - PARKER/DANA	<b>RNA</b>	<b>421-00</b>	9-27
INVERTED FLARE MALE RUN TEE - BRASS - PARKER/DANA	<b>RPA</b>	<b>422-00</b>	9-27
INVERTED FLARE ADAPT TEE - BRASS - PARKER/DANA	<b>RRA</b>	<b>423-00</b>	9-27
INVERTED FLARE ADAPTERS - BRASS - PARKER/DANA	<b>RSA</b>	<b>424-00</b>	9-28
INVERTED FLARE BRAKE TEES - BRASS - PARKER/DANA	<b>HSD</b>	<b>425-00</b>	9-28
PIPE THREAD FITTINGS - ADAPTERS - BRASS - PARKER/DANA	<b>RTA</b>	<b>426-00</b>	9-28
PIPE THREAD FITTINGS - BUSHINGS - BRASS - PARKER/DANA	<b>RUA</b>	<b>427-00</b>	9-28
PIPE THREAD FITTINGS - REDUCING COUPLINGS - BRASS - PARKER/DANA	<b>RVA</b>	<b>428-00</b>	9-28
PIPE THREAD FITTINGS - REDUCING NIPPLE - BRASS - PARKER/DANA	<b>RWA</b>	<b>429-00</b>	9-28
PIPE THREAD FITTINGS - REDUCING STREET ELBOW - BRASS - PARKER/DANA	<b>RXA</b>	<b>430-00</b>	9-29
PIPE THREAD FITTINGS - REDUCING FEMALE ELBOW - BRASS - PARKER/DANA	<b>RYA</b>	<b>431-00</b>	9-29
PIPE THREAD FITTINGS - SLOTTED PLUG - BRASS - PARKER/DANA	<b>RZA</b>	<b>432-00</b>	9-29
PIPE THREAD FITTINGS - SQUARE PLUG - BRASS - PARKER/DANA	<b>SAA</b>	<b>433-00</b>	9-29
PIPE THREAD FITTINGS - HEX PLUG - BRASS - PARKER/DANA	<b>SBA</b>	<b>434-00</b>	9-29
PIPE THREAD FITTINGS - RECESSED HEX PLUG - BRASS - PARKER/DANA	<b>SDA</b>	<b>436-00</b>	9-29
PIPE THREAD FITTINGS - PIPE CAP - BRASS - PARKER/DANA	<b>SEA</b>	<b>437-00</b>	9-29
PIPE THREAD FITTINGS - UNION - BRASS - PARKER/DANA	<b>SGA</b>	<b>439-00</b>	9-29
PIPE THREAD FITTINGS - COUPLING - BRASS - PARKER/DANA	<b>SHA</b>	<b>440-00</b>	9-29
PIPE THREAD FITTINGS - HEX NIPPLE - BRASS - PARKER/DANA	<b>SJA</b>	<b>441-00</b>	9-29
PIPE THREAD FITTINGS - CLOSE NIPPLE - BRASS - PARKER/DANA	<b>SKA</b>	<b>442-00</b>	9-30
PIPE THREAD FITTINGS - 45° STREET ELBOW - BRASS - PARKER/DANA	<b>SLA</b>	<b>443-00</b>	9-30
PIPE THREAD FITTINGS - 90° STREET ELBOW - BRASS - PARKER/DANA	<b>SMA</b>	<b>444-00</b>	9-30
PIPE THREAD FITTINGS - 90° FEMALE ELBOW - BRASS - PARKER/DANA	<b>SNA</b>	<b>445-00</b>	9-30
PIPE THREAD FITTINGS - MALE BRANCH TEE - BRASS - PARKER/DANA	<b>SPA</b>	<b>446-00</b>	9-30
PIPE THREAD FITTINGS - FEMALE TEE - BRASS - PARKER/DANA	<b>SRA</b>	<b>447-00</b>	9-30
PIPE THREAD FITTINGS - STREET TEE - BRASS - PARKER/DANA	<b>SSA</b>	<b>448-00</b>	9-30
PIPE THREAD FITTINGS - FEMALE CROSS - BRASS - PARKER/DANA	<b>STA</b>	<b>449-00</b>	9-30
PIPE THREAD FITTINGS - MALE ELBOW - BRASS - PARKER/DANA	<b>SUA</b>	<b>450-00</b>	9-30

(CONTINUED...)



**CALL - 1 (800) 723-2826**

# SECTION 9 PRODUCT INDEX

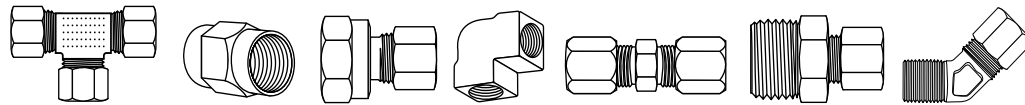

Line Description	Alpha	Line#	Page#
PIPE THREAD FITTINGS - PIPE LOCK NUTS - BRASS - PARKER/DANA	<b>SVA</b>	<b>451-00</b>	9-30
PIPE THREAD FITTINGS - 45° FEMALE ELBOW - BRASS - PARKER/DANA	<b>SWA</b>	<b>452-00</b>	9-31
PIPE THREAD FITTINGS - LONG NIPPLES - BRASS - PARKER/DANA	<b>SXA</b>	<b>452-01</b>	9-31
PIPE THREAD FITTINGS -XLONG NIPPLES - BRASS - PARKER/DANA	<b>SXA</b>	<b>453-00</b>	9-31
TANK & VENT VALVE CAPS	<b>TKA</b>	<b>454-00</b>	9-31
LONG TANK & VENT VALVE CAPS	<b>TKA</b>	<b>455-00</b>	9-31
SHORT VENT VALVES - BRASS	<b>TKA</b>	<b>456-00</b>	9-32
INVERTED FLARE X SAE FLARE - BRASS ADAPTER	<b>TLA</b>	<b>463-00</b>	9-32
MULTI-PURPOSE PIPE THREAD AIR VENT	<b>TLA</b>	<b>464-00</b>	9-32
FORD CARB NUT & FITTING	<b>TLA</b>	<b>468-00</b>	9-32
WATER LINE PIPE THREAD TO HOSE CONNECTOR	<b>TLA</b>	<b>469-00</b>	9-32
WATER LINE PIPE THREAD TO HOSE ELBOW	<b>TLA</b>	<b>470-00</b>	9-32
WIPER HOSE TEE - BRASS	<b>TLA</b>	<b>471-00</b>	9-32
DOUBLE COMPRESSION NUT - BRASS	<b>TMA</b>	<b>472-00</b>	9-32
DOUBLE COMPRESSION UNION - BRASS	<b>TNA</b>	<b>473-00</b>	9-32
DOUBLE COMPRESSION MALE CONNECTOR - BRASS	<b>TPA</b>	<b>474-00</b>	9-32
DOUBLE COMPRESSION MALE ELBOW - BRASS	<b>TRA</b>	<b>475-00</b>	9-32
ANGLE BIB DRAIN COCK - BRASS	<b>TUA</b>	<b>477-00</b>	9-32
ANGLE BIB STYLE DRAIN COCK - BRASS	<b>TUA</b>	<b>478-00</b>	9-33
DRAIN COCK LONG STEM - BRASS	<b>TUA</b>	<b>479-00</b>	9-33
EXTERNAL SEAT DRAIN COCK - BRASS	<b>TUA</b>	<b>480-00</b>	9-33
INTERNAL SEAT DRAIN COCK - BRASS	<b>TUA</b>	<b>481-00</b>	9-33
AIR COCK GROUND PLUG - BRASS - PARKER/DANA	<b>TUA</b>	<b>482-00</b>	9-33
MARINE TYPE MALE/FEMALE PIPE SHUTOFF	<b>TVA</b>	<b>483-00</b>	9-33
FORGED SHUT OFF FEMALE/FEMALE PIPE THREAD - BRASS	<b>TVA</b>	<b>484-00</b>	9-33
FORGED SHUT OFF MALE/MALE PIPE THREAD - BRASS	<b>TVA</b>	<b>485-00</b>	9-33
FORGED SHUT OFF MALE/FEMALE PIPE THREAD - BRASS	<b>TVA</b>	<b>486-00</b>	9-33
SHUT OFF FEMALE/FEMALE PIPE THREAD EXTRUDED	<b>TVA</b>	<b>487-00</b>	9-33
SHUT OFF MALE/MALE PIPE THREAD EXTRUDED	<b>TVA</b>	<b>488-00</b>	9-33
SHUT OFF MALE/FEMALE PIPE THREAD EXTRUDED	<b>TVA</b>	<b>489-00</b>	9-34
TRUCK SHUT OFF WHEEL HANDLE BRASS	<b>TVA</b>	<b>490-00</b>	9-34
SHUT OFF COMP X MPT GROUND PLUG - BRASS	<b>TWA</b>	<b>491-00</b>	9-34
SHUT OFF SAE X MPT GROUND PLUG - BRASS	<b>TWA</b>	<b>492-00</b>	9-34
SHUT OFF COMPRESSION 90° ANGLE - BRASS	<b>TWA</b>	<b>493-00</b>	9-34
SHUT OFF COMP X COMP STRA FORGED - BRASS	<b>TWA</b>	<b>494-00</b>	9-34
SHUT OFF COMPRESSION NEEDLE VALVE - BRASS	<b>TWA</b>	<b>495-00</b>	9-34
SHUT OFF COMP X MPT NEEDLE VALVE - BRASS	<b>TWA</b>	<b>496-00</b>	9-34
SHUT OFF INVERTED FLARE 90° ANGLE - BRASS	<b>TWA</b>	<b>497-00</b>	9-34
SHUT OFF SAE FLARE 90° ANGLE - BRASS	<b>TWA</b>	<b>498-00</b>	9-34
SHUT OFF SAE FL X SAE FL - BRASS	<b>TWA</b>	<b>499-00</b>	9-35

(CONTINUED...)



# SECTION 9 PRODUCT INDEX

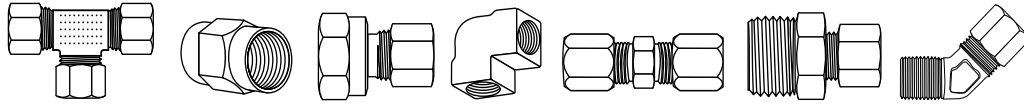

Line Description	Alpha	Line#	Page#
SHUT OFF SAE FL X SAE FL GROUND PLUG - BRASS	<b>TWA</b>	<b>500-00</b>	9-35
SHUT OFF SAE X MPT STRAIGHT - BRASS	<b>TWA</b>	<b>501-00</b>	9-35
SHUT OFF PIPE X HOSE W/FILTER SCREEN	<b>TWA</b>	<b>502-00</b>	9-35
SHUT OFF WATER PIPE TO HOSE STEEL BODY	<b>TWA</b>	<b>503-00</b>	9-35
3/WAY FEMALE PIPE LEVER VALVE BRASS	<b>TZA</b>	<b>509-00</b>	9-35
4/WAY FEMALE PIPE LEVER VALVE BRASS	<b>TZA</b>	<b>510-00</b>	9-35
PARKER BRASS BALL VALVES	<b>AGB</b>	<b>511-02</b>	9-35
SHARPE STAINLESS STEEL BALL VALVES	<b>ASF</b>	<b>511-03</b>	9-35
BRASS BALL VALVES REGULAR STYLE	<b>AGB</b>	<b>511-06</b>	9-36
PRESSURE GAUGES LIQUID/DRY/VACUUM	<b>BDH</b>	<b>511-07</b>	9-36
CARBON STEEL HI-PRESSURE BALL VALVES	<b>AUT</b>	<b>511-10</b>	9-36
PRESTOLOK UNION - BRASS - PARKER	<b>AMY</b>	<b>512-20</b>	9-36
PRESTOLOK BULKHEAD UNION - BRASS - PARKER	<b>AMZ</b>	<b>512-21</b>	9-37
PRESTOLOK FEMALE CONNECTOR - BRASS - PARKER	<b>AND</b>	<b>512-22</b>	9-37
PRESTOLOK UNION TEE - BRASS - PARKER	<b>ANE</b>	<b>512-23</b>	9-37
PRESTOLOK UNION Y CONNECTOR - BRASS - PARKER	<b>ANF</b>	<b>512-24</b>	9-37
PRESTOLOK UNION ELBOW- BRASS - PARKER	<b>ANG</b>	<b>512-25</b>	9-37
PRESTOLOK MALE ELBOW- BRASS - PARKER	<b>ANH</b>	<b>512-26</b>	9-37
PRESTOLOK SWIVEL 90° MALE ELBOW- BRASS - PARKER	<b>ANJ</b>	<b>512-27</b>	9-37
PRESTOLOK MALE CONNECTOR - BRASS - PARKER	<b>ANK</b>	<b>512-28</b>	9-38
PRESTOLOK UNION MALE BRANCH SWIVEL TEE - BRASS - PARKER	<b>CCE</b>	<b>512-29</b>	9-38
PRESTOMATIC AIR BRAKE FEMALE ELBOW - BRASS - PARKER	<b>BMW</b>	<b>512-50</b>	9-38
PRESTOMATIC AIR BRAKE UNION - BRASS - PARKER	<b>BMX</b>	<b>512-51</b>	9-38
PRESTOMATIC AIR BRAKE BULKHEAD UNION - BRASS - PARKER	<b>BMY</b>	<b>512-52</b>	9-38
PRESTOMATIC FEMALE CONNECTOR - BRASS - PARKER	<b>BMZ</b>	<b>512-53</b>	9-38
PRESTOMATIC MALE CONNECTOR - BRASS - PARKER	<b>BND</b>	<b>512-54</b>	9-39
PRESTOMATIC UNION TEE - BRASS - PARKER	<b>BNE</b>	<b>512-55</b>	9-39
PRESTOMATIC UNION ELBOW - BRASS - PARKER	<b>BNF</b>	<b>512-56</b>	9-39
PRESTOMATIC MALE SWIVEL ELBOW - BRASS - PARKER	<b>BNG</b>	<b>512-57</b>	9-39
PRESTOMATIC MALE BRANCH SWIVEL TEE - BRASS - PARKER	<b>BNH</b>	<b>512-58</b>	9-39
PRESTOMATIC MALE ELBOW - BRASS - PARKER	<b>BNJ</b>	<b>512-59</b>	9-39
PRESTOMATIC 45° MALE ELBOW - BRASS - PARKER	<b>BNK</b>	<b>512-60</b>	9-40
TRUE SEAL (GREY ACETAL) MALE CONNECTOR - PARKER	<b>BYT</b>	<b>512-70</b>	9-40

(CONTINUED...)



**CALL - 1 (800) 723-2826**

# SECTION 9 PRODUCT INDEX

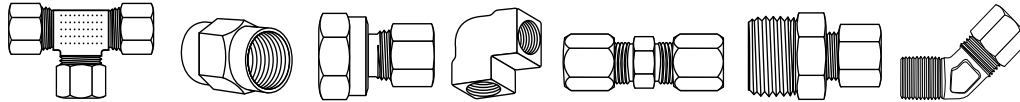

Line Description	Alpha	Line#	Page#
TRUE SEAL (GREY ACETAL) UNION ELBOW - PARKER	<b>BYV</b>	<b>512-71</b>	9-40
TRUE SEAL (GREY ACETAL) UNION TEE - PARKER	<b>BYW</b>	<b>512-72</b>	9-40
TRUE SEAL (GREY ACETAL) MALE ELBOW - PARKER	<b>BYX</b>	<b>512-73</b>	9-40
TRUE SEAL (GREY ACETAL) MALE RUN SWIVEL TEE - PARKER	<b>BYY</b>	<b>512-74</b>	9-40
TRUE SEAL (GREY ACETAL) MALE BRANCH - PARKER	<b>BYZ</b>	<b>512-75</b>	9-40
TRUE SEAL (GREY ACETAL) UNION - PARKER	<b>BZD</b>	<b>512-76</b>	9-40
TRUE SEAL (GREY ACETAL) FEMALE CONNECTOR - PARKER	<b>BZE</b>	<b>512-77</b>	9-41
TRUE SEAL (GREY ACETAL) TUBE STEM X MPT - PARKER	<b>BZF</b>	<b>512-78</b>	9-41
TRUE SEAL (GREY ACETAL) FEMALE ELBOW - PARKER	<b>BZG</b>	<b>512-79</b>	9-41
TRUE SEAL (GREY ACETAL) TUBE X BARB CONNECTOR - PARKER	<b>BZH</b>	<b>512-80</b>	9-41
TRUE SEAL (GREY ACETAL) TUBE X BARB ELBOW - PARKER	<b>BZJ</b>	<b>512-81</b>	9-41
TRUE SEAL (GREY ACETAL) TUBE PLUGS & TOOLS - PARKER	<b>BZK</b>	<b>512-82</b>	9-41
POLY FLOW FITTING SLEEVE - BRASS - PARKER	<b>ZWA</b>	<b>513-00</b>	9-41
POLY FLOW FITTING ACETALSLEEVE - PARKER	<b>ZVA</b>	<b>513-01</b>	9-41
POLY FLOW FITTING SLEEVE NUT ASSEMBLY - BRASS - PARKER	<b>ZXA</b>	<b>514-00</b>	9-41
POLY FLOW FITTING NUT - BRASS - PARKER	<b>ZYA</b>	<b>515-00</b>	9-42
POLY FLOW FITTING UNION - BRASS - PARKER	<b>ZZA</b>	<b>516-00</b>	9-42
POLY FLOW FITTING POLY TO COMP. UNION - BRASS - PARKER	<b>AAB</b>	<b>517-00</b>	9-42
POLY FLOW FITTING POLY TO COMP BULKHEAD UNION - BRASS - PARKER	<b>BMR</b>	<b>517-01</b>	9-42
POLY FLOW FITTING UNION TEE - BRASS - PARKER	<b>ACB</b>	<b>519-00</b>	9-42
POLY FLOW FITTING BULKHEAD UNION - BRASS - PARKER	<b>ADB</b>	<b>520-00</b>	9-42
POLY FLOW FITTING FEMALE CONNECTOR - BRASS - PARKER	<b>AKB</b>	<b>521-00</b>	9-42
POLY FLOW FITTING MALE CONNECTOR - BRASS - PARKER	<b>ALB</b>	<b>522-00</b>	9-42
POLY FLOW FITTING MALE ELBOW - BRASS - PARKER	<b>AMB</b>	<b>523-00</b>	9-43
POLY FLOW FITTING FEMALE ELBOW - BRASS - PARKER	<b>ANB</b>	<b>524-00</b>	9-43
POLY FLOW FITTING MALE RUN TEE - BRASS - PARKER	<b>APB</b>	<b>525-00</b>	9-43
POLY FLOW FITTING MALE BRANCH TEE - BRASS - PARKER	<b>ARB</b>	<b>526-00</b>	9-43
POLY FLOW FITTING FEMALE BRANCH TEE - BRASS - PARKER	<b>ASB</b>	<b>527-00</b>	9-43
POLY FLOW FITTING RED UNION - BRASS - PARKER	<b>ATB</b>	<b>528-00</b>	9-43
POLY FLOW FITTING RED UNION TEE - BRASS - PARKER	<b>AVB</b>	<b>530-00</b>	9-43
POLY FLOW FITTING PLASTIC CAP - PARKER	<b>AWB</b>	<b>531-00</b>	9-43
ERMETO #7000 STEEL FITTING NUT - DANA	<b>JZW</b>	<b>550-03</b>	9-44
ERMETO #7000 STEEL FITTING SLEEVE - DANA	<b>JAX</b>	<b>550-04</b>	9-44
ERMETO #7000 STEEL FITTING CAP - DANA	<b>JBX</b>	<b>550-05</b>	9-44
ERMETO #7000 STEEL FITTING PLUG - DANA	<b>JCX</b>	<b>550-06</b>	9-44
ERMETO #7000 STEEL FITTING BULK HEAD NUT - DANA	<b>JDY</b>	<b>550-07</b>	9-45
ERMETO #7000 STEEL FITTING MALE CONNECTOR - DANA	<b>JEX</b>	<b>550-08</b>	9-45
ERMETO #7000 STEEL FITTING FEMALE CONNECTOR - DANA	<b>JFX</b>	<b>550-09</b>	9-45
ERMETO #7000 STEEL FITTING UNION - DANA	<b>JGX</b>	<b>550-10</b>	9-45
ERMETO #7000 STEEL FITTING 45° MALE ELBOW - DANA	<b>JHX</b>	<b>550-11</b>	9-45

(CONTINUED...)

# SECTION 9 PRODUCT INDEX

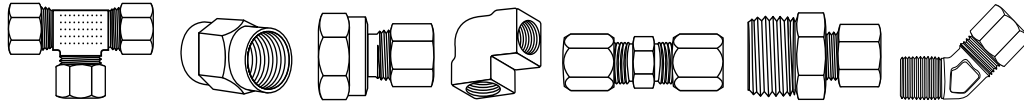

Line Description	Alpha	Line#	Page#
ERMETO #7000 STEEL FITTING MALE ELBOW - DANA	<b>JJX</b>	<b>550-12</b>	9-45
ERMETO #7000 STEEL FITTING FEMALE ELBOW - DANA	<b>JKX</b>	<b>550-13</b>	9-46
ERMETO #7000 STEEL FITTING UNION ELBOW - DANA	<b>JLX</b>	<b>550-14</b>	9-46
ERMETO #7000 STEEL FITTING MALE BRANCH TEE - DANA	<b>JMX</b>	<b>550-15</b>	9-46
ERMETO #7000 STEEL FITTING UNION TEE - DANA	<b>JNX</b>	<b>550-16</b>	9-46
ERMETO #7000 STEEL FITTING MALE RUN TEE - DANA	<b>JPX</b>	<b>550-17</b>	9-46
ERMETO #8000 STEEL FITTING METRIC DIESEL NUT - DANA	<b>JSX</b>	<b>550-19</b>	9-46
ERMETO #8000 STEEL FITTING METRIC DIESEL NUT SLEEVE- DANA	<b>JTX</b>	<b>550-20</b>	9-46
ERMETO #7000 STEEL FITTING FEMALE BRANCH TEE - DANA	<b>AGD</b>	<b>550-22</b>	9-47
FERULOK/ERMETO STEEL FITTING O-RING MALE CONNECTOR - DANA	<b>ARD</b>	<b>550-50</b>	9-47
FERULOK/ERMETO STEEL FITTING O-RING MALE ELBOW - DANA	<b>ARE</b>	<b>550-51</b>	9-47
FERULOK/ERMETO STEEL FITTING O-RING 45° MALE ELBOW - DANA	<b>ARF</b>	<b>550-52</b>	9-47
FERULOK/ERMETO STEEL FITTING O-RING MALE RUN TEE - DANA	<b>ARG</b>	<b>550-53</b>	9-47
FERULOK/ERMETO STEEL FITTING O-RING MALE BRANCH TEE - DANA	<b>ARH</b>	<b>550-54</b>	9-47
FERULOK/ERMETO STEEL FITTING SWIVEL NUT 90° ELBOW - DANA	<b>ARJ</b>	<b>550-55</b>	9-47
FERULOK/ERMETO STEEL FITTING SWIVEL RUN TEE - DANA	<b>ARK</b>	<b>550-56</b>	9-47
FERULOK/ERMETO STEEL FITTING SWIVEL BRANCH TEE - DANA	<b>ARL</b>	<b>550-57</b>	9-48
STEEL BRAKE LINES W/INVERTED FLARE NUTS	<b>ZLA</b>	<b>551-00</b>	9-48
STEEL BRAKE LINES BRITISH BULB FLARE	<b>JUX</b>	<b>551-01</b>	9-48
STEEL BRAKE LINES EUROPEAN BULB FLARE	<b>JVX</b>	<b>551-02</b>	9-48
STEEL BRAKE LINES JAPANESE STANDARD FLARE	<b>JWX</b>	<b>551-03</b>	9-48



**CALL - 1 (800) 723-2826**

# SECTION 9 PRODUCT INDEX

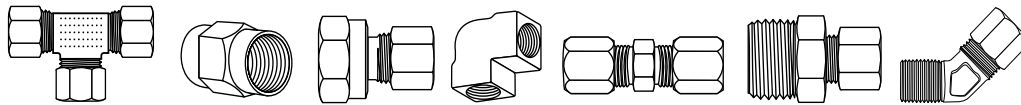

## HI-VALUE INDUSTRIAL BRASS FITTINGS

Line Description	Alpha	Line#	Page#
IND SAE FLARE REGULAR NUT - BRASS	BUD	551-25	9-48
IND SAE FLARE LONG NUT - BRASS	BUE	551-26	9-49
IND SAE FLARE CAP - BRASS	BUF	551-27	9-49
IND SAE FLARE PLUG - BRASS	BUG	551-28	9-49
IND SAE FLARE UNION - BRASS	BUH	551-29	9-49
IND SAE FLARE REDUCING UNION - BRASS	BUJ	551-30	9-49
IND SAE FLAREMALE X FEMALE REDUCER - BRASS	BUK	551-31	9-49
IND SAE FLARE MALE CONNECTOR- BRASS	BUL	551-32	9-49
IND SAE FLARE MALE ELBOW- BRASS	BUM	551-33	9-50
IND SAE FLARE FEMALE CONNECTOR- BRASS	BUN	551-34	9-50
IND SAE FLARE SWIVEL NUT UNION - BRASS	BUP	551-35	9-50
IND SAE FLARE FEMALE ELBOW - BRASS	BUR	551-36	9-51
IND SAE FLARE 45° MALE ELBOW - BRASS	BUT	551-37	9-51
IND SAE FLARE UNION TEE - BRASS	BUV	551-38	9-51
IND SAE FLARE REDUCING UNION TEE - BRASS	BUW	551-39	9-51
IND SAE FLARE UNION ELBOW - BRASS	BUX	551-40	9-51
IND SAE FLARE FORGED NUT - BRASS	BUY	551-41	9-51
IND SAE FLARE MALE BRANCH TEE - BRASS	BUZ	551-42	9-52
IND SAE FLARE MALE RUN TEE - BRASS	BVD	551-43	9-52
IND INVERTED FLARE NUT - BRASS	BVE	551-50	9-52
IND INVERTED FLARE UNION - BRASS	BVF	551-51	9-52
IND INVERTED FLARE MALE CONNECTOR - BRASS	BVG	551-52	9-52
IND INVERTED FLARE MALE ELBOW - BRASS	BVH	551-53	9-53
IND INVERTED FLARE 45° MALE ELBOW - BRASS	BVJ	551-54	9-53
IND INVERTED FLARE UNION TEE- BRASS	BVK	551-55	9-53
IND INVERTED FLARE MALE PLUG - BRASS	BVL	551-56	9-53
IND INVERTED FLARE FEMALE CONNECTOR - BRASS	BVM	551-57	9-53
IND COMPRESSION SHORT NUT - BRASS	BVN	551-60	9-53
IND COMPRESSION SLEEVE - BRASS	BVP	551-61	9-53
IND COMPRESSION UNION - BRASS	BVR	551-62	9-54
IND COMPRESSION UNION TEE- BRASS	BVT	551-63	9-54
IND COMPRESSION MALE RUN TEE- BRASS	BVV	551-64	9-54
IND COMPRESSION MALE BRANCH TEE- BRASS	BVW	551-65	9-54
IND COMPRESSION MALE UNION ELBOW- BRASS	BVX	551-66	9-54
IND COMPRESSION MALE CONNECTOR - BRASS	BVY	551-67	9-55
IND COMPRESSION FEMALE CONNECTOR - BRASS	BVZ	551-68	9-55
IND COMPRESSION MALE ELBOW - BRASS	BWD	551-69	9-55
IND COMPRESSION 45° MALE ELBOW - BRASS	BWE	551-70	9-55

(CONTINUED...)

# SECTION 9 PRODUCT INDEX

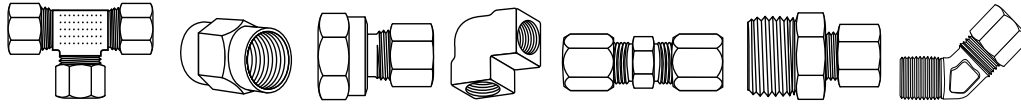

## HI-VALUE INDUSTRIAL BRASS FITTINGS

Line Description	Alpha	Line#	Page#
IND COMPRESSION FEMALE ELBOW - BRASS	<b>BWF</b>	<b>551-71</b>	9-56
IND PIPE THREAD FEMALE ELBOW - BRASS	<b>BWG</b>	<b>551-80</b>	9-56
IND PIPE THREAD 45° FEMALE ELBOW - BRASS	<b>BWH</b>	<b>551-81</b>	9-56
IND PIPE THREAD FEMALE UNION TEE - BRASS	<b>BWJ</b>	<b>551-82</b>	9-56
IND PIPE THREAD FEMALE COUPLING - BRASS	<b>BWK</b>	<b>551-83</b>	9-56
IND PIPE THREAD SCREWED UNION - BRASS	<b>BWL</b>	<b>551-84</b>	9-56
IND PIPE THREAD FEMALE CAP - BRASS	<b>BWM</b>	<b>551-85</b>	9-56
IND PIPE THREAD SQUARE PLUG - BRASS	<b>BWN</b>	<b>551-86</b>	9-56
IND PIPE THREAD REDUCING BUSHING - BRASS	<b>BWP</b>	<b>551-87</b>	9-57
IND PIPE THREAD LONG NIPPLE - BRASS	<b>BWR</b>	<b>551-88</b>	9-57
IND PIPE THREAD CLOSE NIPPLE - BRASS	<b>BWT</b>	<b>551-89</b>	9-57
IND PIPE THREAD 90° STREET ELBOW - BRASS	<b>BWV</b>	<b>551-90</b>	9-57
IND PIPE THREAD ADAPTER - BRASS	<b>BWW</b>	<b>551-91</b>	9-57
IND PIPE THREAD HEX PLUG - BRASS	<b>BWX</b>	<b>551-92</b>	9-58
IND PIPE THREAD HEX NIPPLE - BRASS	<b>BWY</b>	<b>551-93</b>	9-58
IND PIPE THREAD REDUCING HEX NIPPLE - BRASS	<b>BWZ</b>	<b>551-94</b>	9-58
IND PIPE THREAD 45° STREET ELBOW - BRASS	<b>BXA</b>	<b>551-95</b>	9-58
IND PIPE THREAD REDUCING COUPLING - BRASS	<b>BXD</b>	<b>551-96</b>	9-58
IND PIPE THREAD COUNTERSUNK HEX PLUG - BRASS	<b>BXE</b>	<b>551-97</b>	9-58
IND NEEDLE VALVES COMP/FLARE/PIPE	<b>BXF</b>	<b>552-10</b>	9-58
IND GROUND PLUG VALVES COMPRESSION/FLARE/PIPE	<b>BXG</b>	<b>552-11</b>	9-59
IND DRAIN COCKS INTERNAL & EXTERNAL SEAT TYPES	<b>BXH</b>	<b>552-12</b>	9-59



**CALL - 1 (800) 723-2826**

## SAE FLARE SHORT NUT

BRASS

Line: 326-00

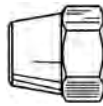

PART NO.	SIZE	QTY/BX	LIST PRICE
LFA1110X2	1/8 (41FS-2)	5	
LFA1110X3	3/16 (41FS-3)	5	
LFA1110X4	1/4 (41FS-4)	5	
LFA1110X5	5/16 (41FS-5)	5	
LFA1110X6	3/8 (41FS-6)	5	
LFA1110X8	1/2 (41FS-8)	5	
LFA1110X10	5/8 (41FS-10)	5	
LFA1110X12	3/4 (41FS-12)	5	

## SAE FLARE LONG NUT

BRASS

Line: 327-00

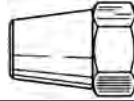

PART NO.	SIZE	QTY/BX	LIST PRICE
LGAN22	1/8 (41FL-2)	5	
LGA41X3	3/16 (41FL-3)	5	
LGA41X4	1/4 (41FL-4)	5	
LGA41X5	5/16 (41FL-5)	5	
LGA41X6	3/8 (41FL-6)	5	
LGA41X8	1/2 (41FL-8)	5	
LGA41X10	5/8 (41FL-10)	5	
LGAN2-12	3/4 (41FL-12)	5	

## SAE FLARE UNION

BRASS

Line: 328-00

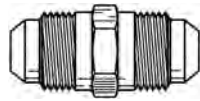

PART NO.	SIZE	QTY/BX	LIST PRICE
LJA42X2	1/8 (42F-2)	5	
LJA42X3	3/16 (42F-3)	5	
LJA42X4	1/4 (42F-4)	5	
LJA42X5	5/16 (42F-5)	5	
LJA42X6	3/8 (42F-6)	5	
LJA42X8	1/2 (42F-8)	5	
LJA42X10	5/8 (42F-10)	5	
LJA42X12	3/4 (42F-12)	5	

## SAE FLARE 3/W TEE

BRASS

Line: 329-00

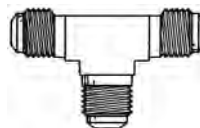

PART NO.	SIZE	QTY/BX	LIST PRICE
LKA44A	1/8	5	
LKA44X3	3/16 (144F-3)	5	
LKA44X4	1/4 (144F-4)	5	
LKA44X5	5/16 (144F-5)	5	
LKA44X6	3/8 (144F-6)	5	
LKA44X8	1/2 (144F-8)	5	
LKA44FFE	1/2 X 1/2 X 3/8	5	
LKA44X10	5/8 (144F-10)	5	

## SAE FLARE CAP

BRASS

Line: 330-00



PART NO.	SIZE	QTY/BX	LIST PRICE
LLAN5B	3/16 (40X3 640F-3)	5	
LLAN5C	1/4 (40X4 640F-4)	5	
LLAN5D	5/16 (40X5 640F-5)	5	
LLAN5E	3/8 (40X6 640F-6)	5	
LLAN5F	1/2 (40X8 640F-8)	5	
LLAN5H	5/8 (40X10 640F-10)	5	
LLAN5J	3/4	5	

## SAE FLARE PLUG

BRASS

Line: 331-00

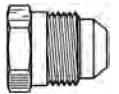

PART NO.	SIZE	QTY/BX	LIST PRICE
LMAP23	3/16 (39X3)	5	
LMAP24	1/4 (39X4 639F-4)	5	
LMAP25	5/16 (39X5 639F-5)	5	
LMAP26	3/8 (39X6 639F-6)	5	
LMAP28	1/2 (39X8 639F-8)	5	
LMAP210	5/8 (39X10 639F-10)	5	
LMAP212	3/4 (39X12)	5	

## SAE FLARE REFER NUT

BRASS

Line: 332-00



PART NO.	SIZE	QTY/BX	LIST PRICE
LNANS4B	3/16	5	
LNANS4C	1/4 (14FSX-4)	5	
LNANS4D	5/16 (14FSX-5)	5	
LNANS4E	3/8 (14FSX-6)	5	
LNANS4F	1/2 (14FSX-8)	5	
LNANS4H	5/8 (14FSX-10)	5	
LNA14FSX12	3/4 (14FSX12)	5	

## SAE FLARE SWIVEL UNION

BRASS

Line: 333-00

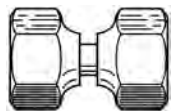

PART NO.	SIZE	QTY/BX	LIST PRICE
LNAUS4C	1/4 (DBL SWIVEL NUT)	5	
LNAUS4DX	5/16	5	
LNAUS4E	3/8 (DBL SWIVEL NUT)	5	
LNAUS4F	1/2 (DBL SWIVEL NUT)	2	
LNAUS4H	5/8 (DBL SWIVEL NUT)	2	
LNAUS4J	3/4	5	

**SAE FLARE UNION ELBOW**

BRASS

Line: 335-00



PART NO.	SIZE	QTY/BX	LIST PRICE
LSA55B	3/16	5	
LSA55X4	1/4 (155F-4)	5	
LSA55X5	5/16 (155F-5)	5	
LSA55X6	3/8 (155F-6)	5	
LSA55X8	1/2 (155F-8)	5	
LSA55X10	5/8 (155F-10)	5	
LSA55J	3/4 (155F-12)	5	

**SAE FLARE BONNET**

BRASS

Line: 336-00



PART NO.	SIZE	QTY/BX	LIST PRICE
LTAB1B	3/16	25	
LTAB1C	1/4 (3GF-4)	25	
LTAB1D	5/16	25	
LTAB1E	3/8 (3GF-6)	25	
LTAB1F	1/2 (3GF-8)	25	
LTAB1H	5/8	10	

**SAE FLARE GASKET**

COPPER

Line: 336-01



PART NO.	SIZE	QTY/BX	LIST PRICE
LUAB2C	1/4	5	
LUAB2E	3/8	5	

**SAE FLARE MALE CONNECTOR**

BRASS

Line: 337-00

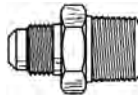

PART NO.	SIZE	QTY/BX	LIST PRICE
LWA48X2	1/8 X 1/8 (48F-2-2)	5	
LWA48X3	3/16 X 1/8 (48F-3-2)	5	
LWA48BB	3/16 X 1/4	5	
LWA48X4	1/4 X 1/8 (48F-4-2)	5	
LWA48X4X4	1/4 X 1/4 (48F-4-4)	5	
LWA48CE	1/4 X 3/8 948F-4-6)	5	
LWA48CF	1/4 X 1/2 (48F-4-8)	5	
LWA48X5	5/16 X 1/8 (48F-5-2)	5	
LWA48X5X4	5/16 X 1/4 (48F-5-4)	5	
LWA48DE	5/16 X 3/8 (48F-5-6)	5	
LWA48DFX	5/16 X 1/2	5	
LWA48X6X2	3/8 X 1/8 (48F-6-2)	5	
LWA48X6	3/8 X 1/4 (48F-6-4)	5	
LWA48X6X6	3/8 X 3/8 (48F-6-6)	5	
LWA48X6X8	3/8 X 1/2 (48F-6-8)	5	
LWA48EJ	3/8 X 3/4 (48F-6-12)	5	
LWA48X7	7/16 X 1/4	5	

(continued...)

**SAE FLARE MALE CONNECTOR (cont.)**

BRASS

Line: 337-00

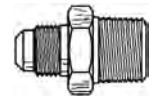

PART NO.	SIZE	QTY/BX	LIST PRICE
LWA48X8X2X	1/2 X 1/8	5	
LWA48X8X4	1/2 X 1/4 (48F-8-4)	5	
LWA48X8	1/2 X 3/8 (48F-8-6)	5	
LWA48X8X8	1/2 X 1/2 (48F-8-8)	5	
LWA48FJ	1/2 X 3/4 (48F-8-12)	5	
LWA48HJ	5/8 X 3/4 (48F-10-12)	5	
LWA48X10X6	5/8 X 3/8 (48F-10-6)	5	
LWA48X10	5/8 X 1/2 (48F-10-8)	5	
LWA48JE	3/4 X 3/8	5	
LWA48X12	3/4 X 1/2 (48F-12-8)	5	
LWA48X12X12	3/4 X 3/4 (48F-12-12)	5	
LWA48NJX	1 X 3/4	5	
LWA48NNX	1 X 1	5	

**SAE FLARE MALE ELBOW**

BRASS

Line: 338-00



PART NO.	SIZE	QTY/BX	LIST PRICE
LXA49X2	1/8 X 1/8 (149F-2-2)	5	
LXA49X3	3/16 X 1/8 (249F-3-2)	5	
LXA49BB	3/16 X 1/4	5	
LXA49X4	1/4 X 1/8 (249F-4-2)	5	
LXA49X4X4	1/4 X 1/4 (249F-4-4)	5	
LXA49X4X6	1/4 X 3/8 (249F-4-6)	5	
LXA49CF	1/4 X 1/2	5	
LXA49X5	5/16 X 1/8 (249F-5-2)	5	
LXA49X5X4	5/16 X 1/4 (249F-5-4)	5	
LXA49DE	5/16 X 3/8 (149F-5-6)	5	
LXA49X6X2	3/8 X 1/8 (249F-6-2)	5	
LXA49X6	3/8 X 1/4 (249F-6-4)	5	
LXA49X6X6	3/8 X 3/8 (249F-6-6)	5	
LXA49X6X8	3/8 X 1/2 (249F-6-8)	5	
LXA49EJ	3/8 X 3/4 (149F-6-12)	5	
LXA49FA	1/2 X 1/8	5	
LXA49X8X4	1/2 X 1/4 (149F-8-4)	5	
LXA49X8	1/2 X 3/8 (249F-8-6)	5	
LXA49X8X8	1/2 X 1/2 (249F-8-8)	5	
LXA49FJ	1/2 X 3/4 (149F-8-12)	5	
LXA49X10X6	5/8 X 3/8 (149F-10-6)	5	
LXA49X10	5/8 X 1/2 (249F-10-8)	5	
LXA49HJ	5/8 X 3/4 (149F-10-12)	5	
LXA49X12	3/4 X 1/2 (149F-12-8)	5	
LXA49X12X12	3/4 X 3/4 (149F12-12)	5	
LXA49JNX	3/4 X 1	5	

## SAE FLARE FEMALE ELBOW

BRASS

Line: 339-00

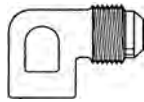

PART NO.	SIZE	QTY/BX	LIST PRICE
LYA50AX	1/8 X 1/8	5	
LYA50X3	3/16 X 1/8	5	
LYA50X4	1/4 X 1/8 (150F-4-2)	5	
LYA50X4X4	1/4 X 1/4 (150F-4-4)	5	
LYA50X5	5/16 X 1/8	5	
LYA50X5X4	5/16 X 1/4 (150F-5-4)	5	
LYA50EX	3/8 X 1/8 (150F-6-2)	5	
LYA50X6	3/8 X 1/4 (150F-6-4)	5	
LYA50X6X6	3/8 X 3/8 (150F-6-6)	5	
LYA54EF	3/8 X 1/2	5	
LYA54EJ	3/8 X 3/4	5	
LYA50FC	1/2 X 1/4	5	
LYA50X8	1/2 X 3/8 (150F-8-6)	5	
LYA50X8X8	1/2 X 1/2 (150F-8-8)	5	
LYA50HE	5/8 X 3/8	5	
LYA50X10	5/8 X 1/2 (150F-10-8)	5	
LYA50J	3/4 X 1/2	5	

## SAE FLARE FEMALE CONNECTOR

BRASS

Line: 340-00

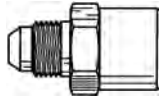

PART NO.	SIZE	QTY/BX	LIST PRICE
LZA46A	1/8 X 1/8 (46F-2-2)	5	
LZA46X3	3/16 X 1/8 (46F-3-2)	5	
LZA46X4	1/4 X 1/8 (46F-4-2)	5	
LZA46X4X4	1/4 X 1/4 (46F-4-4)	5	
LZA46CFX	1/4 X 1/2	5	
LZA46X5X4	5/16 X 1/4 (46F-5-4)	5	
LZA46X5	5/16 X 1/8 (46F-5-2)	5	
LZA46X6X2	3/8 X 1/8 (46F-6-2)	5	
LZA46X6	3/8 X 1/4 (46F-6-4)	5	
LZA46X6X6	3/8 X 3/8 (46F-6-6)	5	
LZA46X6X8	3/8 X 1/2 (46F-6-8)	5	
LZA46X8X4	1/2 X 1/4	5	
LZA46X8	1/2 X 3/8 (46F-8-6)	5	
LZA46X8X8	1/2 X 1/2	5	
LZA46X10	5/8 X 1/2 (46F-10-8)	5	
LZA46HJ	5/8 X 3/4 (46F-10-12)	5	
LZA46J	3/4 X 1/2	5	
LZA46JJ	3/4 X 3/4	5	

## SAE FLARE 45° MALE ELBOW

BRASS

Line: 341-00

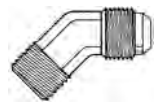

PART NO.	SIZE	QTY/BX	LIST PRICE
MAA56BX	3/16 X 1/8	5	
MAA54X4	1/4 X 1/8 (159F-4-2)	5	
MAA56CC	1/4 X 1/4 (159F-4-4)	5	
MAA56CE	1/4 X 3/8	5	
MAA54X5	5/16 X 1/8 (159F-5-2)	5	
MAA56DD	5/16 X 1/4 (159F-5-4)	5	
MAA54X6	3/8 X 1/4 (159F-6-4)	5	
MAA56EEE	3/8 X 3/8 (159F-6-6)	5	
MAA54X8	1/2 X 3/8 (159F-8-6)	5	
MAA56FF	1/2 X 1/2 (159F-8-8)	5	
MAA54X10	5/8 X 1/2 (159F-10-8)	5	
MAA56J	3/4 X 1/2 (159F-12-8)	5	

## SAE FLARE REDUCING UNION

BRASS

Line: 342-00

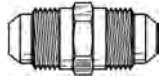

PART NO.	SIZE	QTY/BX	LIST PRICE
MBAG42CBX	1/4 X 3/16	5	
MBAG42EC	3/8 X 1/4 (42F-6-4)	5	
MBAG42ED	3/8 X 5/16	5	
MBAG42FCX	1/2 X 1/4	5	
MBAG42FE	1/2 X 3/8 (42F-8-6)	5	
MBAG42HF	5/8 X 1/2 (42F-10-8)	5	
MBAG42JF	3/4 X 1/2	5	

## SAE FLARE MALE X FEMALE

BRASS

Line: 343-00

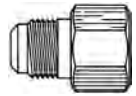

PART NO.	SIZE	QTY/BX	LIST PRICE
MCAUR3CE	1/4 X 3/8	5	
MCAUR3EC	3/8 X 1/4 (661FHD-6-4)	5	
MCAUR3FE	1/2 X 3/8 (661FHD-8-6)	5	
MCAUR3HF	5/8 X 1/2	5	



### SAE FLARE 2/WAY TEE BRANCH

BRASS

Line: 345-00

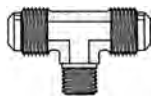

PART NO.	SIZE	QTY/BX	LIST PRICE
MEA45X3	3/16 X 1/8	5	
MEA45X4	1/4 X 1/8 (145F-4-2)	5	
MEA45X4X4	1/4 X 1/4 (145F-4-4)	5	
MEA45X5	5/16 X 1/8	5	
MEA45X5X4	5/16 X 1/4	5	
MEA45X6	3/8 X 1/4 (145F-6-4)	5	
MEA45X6X6	3/8 X 3/8 (145F-6-6)	5	
MEA45EFX	3/8 X 1/2	5	
MEA45X8	1/2 X 3/8 (145F-8-6)	5	
MEA45X8X8	1/2 X 1/2	5	
MEA45X10	5/8 X 1/2	5	

### SAE FLARE 2/WAY TEE ML RUN

BRASS

Line: 346-00

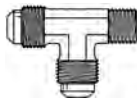

PART NO.	SIZE	QTY/BX	LIST PRICE
MFA51X3	3/16 X 1/8	5	
MFA51CC	1/4 X 1/4 (151F-4-4)	5	
MFA51X4	1/4 X 1/8 (151F-4-2)	5	
MFA51X5	5/16 X 1/8	5	
MFA51X5X4	5/16 X 1/4	5	
MFA51X6	3/8 X 1/4 (151F-6-4)	5	
MFA51X6X6	3/8 X 3/8 (151F-6-6)	5	
MFA51X8X8	1/2 X 1/2 (151F-8-8)	5	
MFA51X10	5/8 X 1/2 (151F-10-8)	5	

### SAE FLARE #56 ADAPTER TEE

BRASS

Line: 347-00



PART NO.	SIZE	QTY/BX	LIST PRICE
MHA56X4	1/4 X 1/8 (256F-4-2)	5	

### SAE FLARE CHECK VALVE MALE CONN

BRASS

Line: 348-00

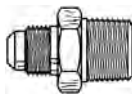

PART NO.	SIZE	QTY/BX	LIST PRICE
MJA43X4	1/4 X 1/8	5	
MJA43X6	3/8 X 1/4	5	

### COMPRESSION SHORT NUT

BRASS

Line: 349-00



PART NO.	SIZE	QTY/BX	LIST PRICE
MKA61X2	1/8 (61C-2)	10	
MKA61AAX	5/32	10	
MKA61X3	3/16 (61C-3)	10	
MKA61X4	1/4 (61C-4)	10	
MKA61X5	5/16 (61C-5)	10	
MKA61X6	3/8 (61C-6)	10	
MKA61X7	7/16 (61C-7)	10	
MKA61X8	1/2 (61C-8)	10	
MKA61X10	5/8 (61C-10)	10	
MKA61X12	3/4 (61C-12)	5	
MKA61X14X	7/8	5	

### COMPRESSION LONG NUT

BRASS

Line: 350-00

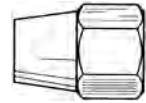

PART NO.	SIZE	QTY/BX	LIST PRICE
MLA161AX	1/8	5	
MLA1611X3	3/16	5	
MLA1611X4	1/4 (61CL-4)	5	
MLA1611X5	5/16 (61CL-5)	5	
MLA1611X6	3/8 (61CL-6)	5	
MLA1611X8	1/2 (61CL-8)	5	
MLA1611X10	5/8 (61CL-10)	5	
MLA1611X12	3/4 (61CL-12)	5	
MLA1611X16	1	5	

### COMPRESSION SLEEVE

BRASS

Line: 351-00



PART NO.	SIZE	QTY/BX	LIST PRICE
MMA60X2	1/8 (60C-2)	50	
MMA660A	1/8 SURE GRIP	25	
MMA60AA	5/32	25	
MMA60X3	3/16 (60C-3)	50	
MMA60X4	1/4 (60C-4)	50	
MMA60X5	5/16 (60C-5)	50	
MMA60X6	3/8 (60C-6)	50	
MMA60X7	7/16 (60C-7)	50	
MMA60X8	1/2 (60C-8)	25	
MMA60X10	5/8 (60C-10)	10	
MMA60X12	3/4 (60C-12)	10	
MMA60M	7/8	10	
MMA60X16	1	10	

## COMP NYLON SLEEVE FOR POLY TUBE



Line: 351-02

PART NO.	SIZE	QTY/BX	LIST PRICE
NKA460C	1/4 (60PT-4)	25	
NKA460D	5/16 (60PT-5)	25	
NKA460E	3/8 (60PT-6)	25	
NKA460F	1/2 (60PT-8)	25	
NKA460H	5/8 (60PT-10)	25	

## COMP POLY TUBE BRASS INSERTS

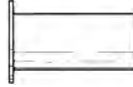

Line: 351-03

PART NO.	SIZE	QTY/BX	LIST PRICE
NLA461A	1/8 (63PT216 .080 OD)	25	
NLA461B	3/16 (63PT-3-25)	25	
NLA2030X4	1/4 X .062WALL .126ID	25	
NLA2030X4A	1/4 X .040WALL .170ID	25	
NLA2030X5	5/16 (63PT-5-62)	25	
NLA461DOSX	5/16 (.23205 63PT-540)	25	
NLATH461DX	5/16	25	
NLA2030X6	3/8 (63PT-6-62)	25	
NLA2030X8	1/2	25	
NLA2030X10	5/8	10	
NLA2030X12	3/4	5	
NLAM4	4 MM (100187501907X)	25	
NLAM5	5 MM (100187501908X)	25	

## COMPRESSION UNION

BRASS

Line: 352-00

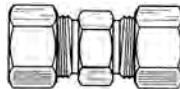

PART NO.	SIZE	QTY/BX	LIST PRICE
MNA62X2	1/8 (62C-2)	5	
MNA62X3	3/16 (62C-3)	5	
MNA62X4	1/4 (62C-4)	5	
MNA62X5	5/16 (62C-5)	5	
MNA62X6	3/8 (62C-6)	5	
MNA62X8	1/2 (62C-8)	5	
MNA62X10	5/8 (62C-10)	5	
MNA62X12	3/4 (62C-12)	5	
MNA62X14	7/8 (62C-14)	5	

## COMPRESSION UNION ELBOW

BRASS

Line: 353-00

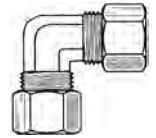

PART NO.	SIZE	QTY/BX	LIST PRICE
MPA65A	1/8 (165C-2)	5	
MPA65X3	3/16 (165C-3)	5	
MPA65X4	1/4 (265C-4)	5	
MPA65X5	5/16 (165C-5)	5	
MPA65X6	3/8 (165C-6)	5	
MPA65RECX	3/8 X 1/4 REDUCING	5	
MPA65X8	1/2 (165C-8)	5	
MPA65RFEX	1/2 X 3/8 REDUCING	5	
MPA65H	5/8 (165C-10)	5	
MPA65J	3/4	5	

## COMPRESSION 3/WAY UNION TEE

BRASS

Line: 354-00

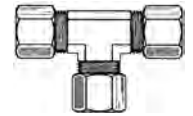

PART NO.	SIZE	QTY/BX	LIST PRICE
MRA64A	1/8 (164C-2)	5	
MRA64X3	3/16 (264C-3)	5	
MRA64X4	1/4 (264C-4)	5	
MRA64X5	5/16 (164C-5)	5	
MRA64X6	3/8 (164C-6)	5	
MRA64EEC	3/8 X 3/8 X 1/4	5	
MRA64X8	1/2 (164C-8)	5	
MRA64H	5/8 (164C-10)	5	
MRA64J	3/4	5	

## COMPRESSION BULKHEAD UNION

BRASS

Line: 355-00

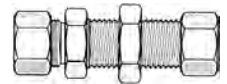

PART NO.	SIZE	QTY/BX	LIST PRICE
MSA74X4	1/4	5	
MSA74X5	5/16	5	
MSA74X6	3/8	5	
MSA74X8	1/2	5	



CALL - 1 (800) 723-2826

### COMPRESSION MALE CONN

BRASS

Line: 356-00

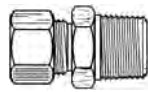

PART NO.	SIZE	QTY/BX	LIST PRICE
MTA68X2	1/8 X 1/8 (68C-2-2)	5	
MTA68BB	3/16 X 1/4 (68C-3-4)	5	
MTA68X3	3/16 X 1/8 (68C-3-2)	5	
MTA68X4	1/4 X 1/8 (68C-4-2)	5	
MTA68X4X4	1/4 X 1/4 (68C-4-4)	5	
MTA68CE	1/4 X 3/8 (68C-4-6)	5	
MTA68CF	1/4 X 1/2 (68C-4-8)	5	
MTA68X5	5/16 X 1/8 (68C-5-2)	5	
MTA68X5X4	5/16 X 1/4 (68C-5-4)	5	
MTA68DE	5/16 X 3/8	5	
MTA68E	3/8 X 1/8 (68C-6-2)	5	
MTA68X6	3/8 X 1/4 (68C-6-4)	5	
MTA68X6X6	3/8 X 3/8 (68C-6-6)	5	
MTA68X6X8	3/8 X 1/2 (68C-6-8)	5	
MTA68EJ	3/8 X 3/4	5	
MTA68X7	7/16 X 1/4 (68C-7-4)	5	
MTA68FAX	1/2 X 1/8	5	
MTA68X8X4	1/2 X 1/4 (68C-8-4)	5	
MTA68X8	1/2 X 3/8 (68C-8-6)	5	
MTA68X8X8	1/2 X 1/2 (68C-8-8)	5	
MTA68FJ	1/2 X 3/4	5	
MTA68HE	5/8 X 3/8 (68C-10-6)	5	
MTA68X10	5/8 X 1/2 (68C-10-8)	5	
MTA68HJ	5/8 X 3/4 (68C-10-12)	5	
MTA68X12	3/4 X 1/2 (68C-12-8)	5	
MTA68X12X12	3/4 X 3/4 (68C-12-12)	5	
MTA68MN	7/8 X 1	5	

### COMPRESSION MALE ELBOW

BRASS

Line: 357-00



PART NO.	SIZE	QTY/BX	LIST PRICE
MUA69X2	1/8 X 1/8 (269C-2-2)	5	
MUA69BB	3/16 X 1/4 (169C-3-4)	5	
MUA69X3	3/16 X 1/8 (269C-3-2)	5	
MUA69X4	1/4 X 1/8 (269C-4-2)	5	
MUA69X4X4	1/4 X 1/4 (269C-4-4)	5	
MUA69CE	1/4 X 3/8 (169C-4-6)	5	
MUA69CF	1/4 X 1/2 (169C-4-8)	5	
MUA69X5	5/16 X 1/8 (269C-5-2)	5	
MUA69X5X4	5/16 X 1/4 (269C-5-4)	5	
MUA69DE	5/16 X 3/8 (169C-5-6)	5	
MUA69DFX	5/16 X 1/2	5	
MUA69X6X2	3/8 X 1/8 (269C-6-2)	5	
MUA69X6	3/8 X 1/4 (269C-6-4)	5	

(continued...)

### COMPRESSION MALE ELBOW (cont.)

BRASS

Line: 357-00



PART NO.	SIZE	QTY/BX	LIST PRICE
MUA69X6X6	3/8 X 3/8 (269C-6-6)	5	
MUA69X6X8	3/8 X 1/2 (169C-6-8)	5	
MUA69GE	7/16 X 3/8	5	
MUA69X8X4	1/2 X 1/4 (169C-8-4)	5	
MUA69X8	1/2 X 3/8 (169C-8-6)	5	
MUA69X8X8	1/2 X 1/2 (169C-8-8)	5	
MUA69HE	5/8 X 3/8 (169C-10-6)	5	
MUA69X10	5/8 X 1/2 (169C-10-8)	5	
MUA69HJ	5/8 X 3/4	5	
MUA69X12	3/4 X 1/2 (169C-12-8)	5	
MUA69X12X12	3/4 X 3/4 (169C-12-12)	5	

### COMPRESSION FEMALE CONN

BRASS

Line: 358-00



PART NO.	SIZE	QTY/BX	LIST PRICE
MVA66X2	1/8 X 1/8 (66C-2-2)	5	
MVA66X3	3/16 X 1/8 (66C-3-2)	5	
MVA66BB	3/16 X 1/4 (66C-3-4)	5	
MVA66X4	1/4 X 1/8 (66C-4-2)	5	
MVA66X4X4	1/4 X 1/4 (66C-4-4)	5	
MVA66CE	1/4 X 3/8	5	
MVA66CF	1/4 X 1/2	5	
MVA66X5	5/16 X 1/8 (66C-5-2)	5	
MVA66X5X4	5/16 X 1/4 (66C-5-4)	5	
MVA66X6X2	3/8 X 1/8 (66C-6-2)	5	
MVA66X6	3/8 X 1/4 (66C-6-4)	5	
MVA66EEE	3/8 X 3/8 (66C-6-6)	5	
MVA66EF	3/8 X 1/2 (66C-6-8)	5	
MVA66FC	1/2 X 1/4 (66C-8-4)	5	
MVA66X8	1/2 X 3/8 (66C-8-6)	5	
MVA66FF	1/2 X 1/2 (66C-8-8)	5	
MVA66FJX	1/2 X 3/4	5	
MVA66X10	5/8 X 1/2 (66C-10-8)	5	
MVA66JX	3/4 X 1/2	5	

## COMPRESSION FEMALE ELBOW

BRASS

Line: 359-00



PART NO.	SIZE	QTY/BX	LIST PRICE
MWA70A	1/8 X 1/8 (170C-2-2)	5	
MWA70X3	3/16 X 1/8	5	
MWA70X4	1/4 X 1/8 (170C-4-2)	5	
MWA70CC	1/4 X 1/4 (170C-4-4)	5	
MWA70CEX	1/4 X 3/8	5	
MWA70CFX	1/4 X 1/2	5	
MWA70DD	5/16 X 1/4	5	
MWA70X5	5/16 X 1/8	5	
MWA70E	3/8 X 1/8	5	
MWA70X6	3/8 X 1/4 (170C-6-4)	5	
MWA70EEE	3/8 X 3/8 (170C-6-6)	5	
MWA70EJX	3/8 X 3/4	5	
MWA70FC	1/2 X 1/4	5	
MWA70X8	1/2 X 3/8 (170C-8-6)	5	
MWA70FF	1/2 X 1/2	5	
MWA70X10	5/8 X 1/2	5	

## COMPRESSION MALE 45° ELBOW

BRASS

Line: 360-00



PART NO.	SIZE	QTY/BX	LIST PRICE
MXA78B	3/16 X 1/8	5	
MXA78C	1/4 X 1/8 (179C-4-2)	5	
MXA78CC	1/4 X 1/4 (179C-4-4)	5	
MXA78D	5/16 X 1/8	5	
MXA78DD	5/16 X 1/4	5	
MXA78E	3/8 X 1/8 (179C-6-2)	5	
MXA78EE	3/8 X 1/4 (179C-6-4)	5	
MXA78EEE	3/8 X 3/8 (179C-6-6)	5	
MXA78F	1/2 X 3/8 (179C-8-6)	5	
MXA78FF	1/2 X 1/2	5	

## COMPRESSION 2/W BRANCH TEE

BRASS

Line: 361-00

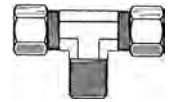

PART NO.	SIZE	QTY/BX	LIST PRICE
MYA72A	1/8 X 1/8 (172C-2-2)	5	
MYA72X3	3/16 X 1/8 (172C-3-2)	5	
MYA72X4	1/4 X 1/8 (172C-4-2)	5	
MYA72X4X4	1/4 X 1/4 (172C-4-4)	5	
MYA72X5	5/16 X 1/8	5	
MYA72DD	5/16 X 1/4	5	
MYA72E	3/8 X 1/8 (172C-6-2)	5	
MYA72X6	3/8 X 1/4 (172C-6-4)	5	
MYA72EEE	3/8 X 3/8 (172C-6-6)	5	
MYA72X8	1/2 X 3/8 (172C-8-6)	5	
MYA72FF	1/2 X 1/2	5	
MYA72H	5/8 X 1/2	5	

## COMPRESSION 2/W RUN TEE

BRASS

Line: 362-00

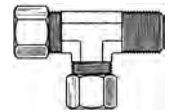

PART NO.	SIZE	QTY/BX	LIST PRICE
MZA71A	1/8 X 1/8 (171C-2-2)	5	
MZA71X3	3/16 X 1/8 (171C-3-2)	5	
MZA71X4	1/4 X 1/8 (171C-4-2)	5	
MZA71X4X4X4	1/4 X 1/4 (171C-4-4)	5	
MZA71DD	5/16 X 1/4	5	
MZA71X5	5/16 X 1/8	5	
MZA71E	3/8 X 1/8	5	
MZA71X6	3/8 X 1/4 (171C-6-4)	5	
MZA71EEE	3/8 X 3/8	5	
MZA71FF	1/2 X 1/2	5	
MZA71X8	1/2 X 3/8	5	
MZA71H	5/8 X 1/2	5	
MZA71J	3/4 X 1/2	5	

## COMPRESSION ADAPTER TEE

BRASS FITTING

Line: 363-00



PART NO.	SIZE	QTY/BX	LIST PRICE
NAA76A3A	3/16 X 1/8	5	
NAA76X4	1/4 X 1/8	5	

## COMPRESSION REDUCING UNION

BRASS FITTING

Line: 364-00

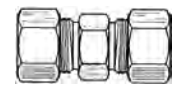

PART NO.	SIZE	QTY/BX	LIST PRICE
NBA62RCA	1/4 X 1/8	5	
NBA62RDC	5/16 X 1/4	5	
NBA62REC	3/8 X 1/4	5	
NBA62RFE	1/2 X 3/8	5	

### COMPRESSION CHECK VALVE

BRASS FITTING

Line: 365-00

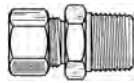

PART NO.	SIZE	QTY/BX	LIST PRICE
NCA63X4	1/4 X 1/8	5	
NCA63X6	3/8 X 1/4	2	

### P/H SELF/ALIGN SLEEVE/NUT ASSEMBLY

Line: 365-99



PART NO.	SIZE	QTY/BX	LIST PRICE
CBV61CAX2	1/8	5	
CBV61CAX3	3/16	5	
CBV61CAX4	1/4	5	
CBV61CAX5	5/16	5	
CBV61CAX6	3/8	5	
CBV61CAX8	1/2	5	
CBV61CAX10	5/8	5	
CBV61CAX12	3/4	5	

### P/H SELF/ALIGN SLEEVE

Line: 366-00



PART NO.	SIZE	QTY/BX	LIST PRICE
HTD601X2	1/8 (61CA-2)	25	
HTD601X3	3/16 (61CA-3)	25	
HTD601X4	1/4 (61CA-4)	25	
HTD601X5	5/16 (61CA-5)	25	
HTD601X6	3/8 (61CA-6)	25	
HTD601X8	1/2 (61CA-8)	25	
HTD601X10	5/8 (61CA-10)	10	
HTD601X12	3/4 (61CA-12)	10	
HTD601X16	1 (61CA-16)	10	

### W/H SELF ALIGN SHORT NUT

Line: 366-01



PART NO.	SIZE	QTY/BX	LIST PRICE
HUD611X2	1/8	5	
HUD611X3	3/16	5	
HUD611X4	1/4	5	
HUD611X5	5/16	5	
HUD611X6	3/8	5	
HUD611X8	1/2	5	
HUD611X10	5/8	5	
HUD611X12	3/4	5	

### W/H SELF ALIGN UNION



Line: 366-03

PART NO.	SIZE	QTY/BX	LIST PRICE
JUV621X2	1/8 (62CA-2)	5	
JUV621X3	3/16 (62CA-3)	5	
JUV621X4	1/4 (62CA-4)	5	
JUV621X5	5/16 (62CA-5)	5	
JUV621X6	3/8 (62CA-6)	5	
JUV621X8	1/2 (62CA-8)	5	
JUV621X10	5/8 (62CA-10)	5	
JUV621X12	3/4 (62CA-12)	5	

### W/H SELF MALE CONNECTOR

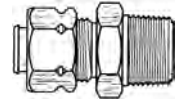

Line: 366-04

PART NO.	SIZE	QTY/BX	LIST PRICE
JVV681X2X1	1/8 X 1/16	5	
JVV681X2	1/8 X 1/8 (68C-2-2)	5	
JVV681X3	3/16 X 1/8 (68C-3-2)	5	
JVV681X3X4	3/16 X 1/4 (68CA-3-4)	5	
JVV681X4	1/4 X 1/8 (68C-4-2)	5	
JVV681X4X4	1/4 X 1/4 (68C-4-4)	5	
JVV681X5	5/16 X 1/8 (68C-5-2)	5	
JVV681X5X4	5/16 X 1/4 (68C-5-4)	5	
JVV681X6X2	3/8 X 1/8 (68C-6-2)	5	
JVV681X6	3/8 X 1/4 (68C-6-4)	5	
JVV681X6X6	3/8 X 3/8 (68C-6-6)	5	
JVV681X6X8	3/8 X 1/2	5	
JVV681X8X4	1/2 X 1/4	5	
JVV681X8	1/2 X 3/8	5	
JVV681X8X8	1/2 X 1/2	5	
JVV681X10	5/8 X 1/2	5	
JVV681X12	3/4 X 1/2	5	
JVV681X12X12	3/4 X 3/4	5	
JVV1681X16	1 X 1	1	



**CALL - 1 (800) 723-2826**

## W/H SELF ALIGN MALE ELBOW

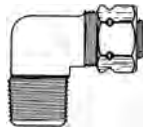

Line: 366-05

PART NO.	SIZE	QTY/BX	LIST PRICE
JWV691X2X1	1/8 X 1/16	5	
JWV691X2	1/8 X 1/8 (269C-2-2)	5	
JWV691X3	3/16 X 1/8 (269C-3-2)	5	
JWV691X4	1/4 X 1/8 (269C-4-2)	5	
JWV691X4X4	1/4 X 1/4	5	
JWV691X5	5/16 X 1/8 (269C-5-2)	5	
JWV691X5X4	5/16 X 1/4	5	
JWV691X6	3/8 X 1/4 (269C-6-4)	5	
JWV691X6X2	3/8 X 1/8	5	
JWV691X6X6	3/8 X 3/8	5	
JWV691X6X8	3/8 X 1/2	5	
JWV691X8X4	1/2 X 1/4	5	
JWV691X8	1/2 X 3/8	5	
JWV691X8X8	1/2 X 1/2	5	
JWV691X10	5/8 X 1/2	5	
JWV691X12	3/4 X 1/2	5	
JWV691X12X12	3/4 X 3/4	5	

## W/H SELF ALIGN UNION ELBOW

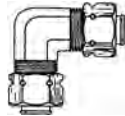

Line: 366-06

PART NO.	SIZE	QTY/BX	LIST PRICE
JXV651X3	3/16	5	
JXV651X4	1/4	5	
JXV651X5	5/16	5	
JXV651X6	3/8	5	
JXV651X8	1/2	5	

## W/H SELF ALIGN FEMALE CONNECTOR



Line: 366-07

PART NO.	SIZE	QTY/BX	LIST PRICE
JYV661X2	1/8 X 1/8	5	
JYV661X3	3/16 X 1/8	5	
JYV661X4	1/4 X 1/8	5	
JYV661X4X4	1/4 X 1/4	5	
JYV661X5	5/16 X 1/8	5	
JYV661X5X4	5/16 X 1/4	5	
JYV661X6X2	3/8 X 1/8	5	
JYV661X6	3/8 X 1/4	5	
JYV661X8	1/2 X 3/8	5	
JYV661X10	5/8 X 1/2	5	

## W/H SELF ALIGN FEMALE ELBOW

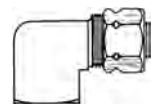

Line: 366-08

PART NO.	SIZE	QTY/BX	LIST PRICE
JZV701X3	3/16 X 1/8	5	
JZV701X4	1/4 X 1/8	5	
JZV701X6	3/8 X 1/4	5	
JZV701X8	1/2 X 3/8	5	

## W/H SELF ALIGN UNION TEE

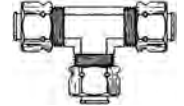

Line: 366-09

PART NO.	SIZE	QTY/BX	LIST PRICE
JAW641X3	3/16	5	
JAW641X4	1/4	5	
JAW641X5	5/16	5	
JAW641X6	3/8	5	
JAW641X8	1/2	5	

## W/H SELF ALIGN MALE RUN TEE

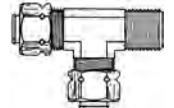

Line: 366-10

PART NO.	SIZE	QTY/BX	LIST PRICE
JBW711X3	3/16 X 1/8	5	
JBW711X4	1/4 X 1/8	5	
JBW711X4X4	1/4 X 1/4	5	
JBW711X6	3/8 X 1/4	5	

## W/H SELF ALIGN MALE BRANCH TEE

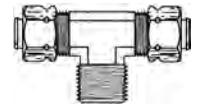

Line: 366-11

PART NO.	SIZE	QTY/BX	LIST PRICE
JCW721X3	3/16 X 1/8	5	
JCW721X4	1/4 X 1/8	5	
JCW721X4X4X4	1/4 X 1/4	5	
JCW721X5	5/16 X 1/8	5	
JCW721X6	3/8 X 1/4	5	
JCW721X8	1/2 X 3/8	5	

## 60 VL VIBRA LOCK RUBBER SLEEVE



Line: 367-12

PART NO.	SIZE	QTY/BX	LIST PRICE
JXX60FLO2	1/8	50	
JXX60FLO3	3/16 (60VL-3)	50	
JXX60FLO4	1/4 (60VL-4)	50	
JXX60FLO5	5/16 (60VL-5)	50	
JXX60FLO6	3/8 (60VL-6)	50	
JXX60FLO8	1/2 (60VL-8)	25	
JXX60FL10	5/8 (60VL-10)	25	
JXX60FL12	3/4	25	

## AIR BRAKE LONG NUT

BRASS FITTING

Line: 368-00



PART NO.	SIZE	QTY/BX	LIST PRICE
NFAW00455	1/4 (61AB-4 1361X4)	5	
NFA261-D	5/16	5	
NFAW00360	3/8 (61AB-6 1361X6)	5	
NFAW03755	1/2 (61AB-8 1361X8)	5	
NFAW10613	5/8 (61AB-10 1361X10)	5	
NFAW03896	3/4 (61AB-12 1361X12)	5	

## AIR BRAKE SLEEVE

BRASS FITTING

Line: 369-00



PART NO.	SIZE	QTY/BX	LIST PRICE
NEAW00457	1/4 (60AB-4 1360X4)	25	
NEA260-D	5/16	25	
NEAW00361	3/8 (60AB-6 1360X6)	25	
NEAW03754	1/2 (60AB-8 1360X8)	10	
NEAW10612	5/8 (60AB-10 1360X10)	10	
NEAW03897	3/4 (60AB-12 1360X12)	10	

## AIR BRAKE LONG UNION

BRASS FITTING

Line: 370-00



PART NO.	SIZE	QTY/BX	LIST PRICE
NGAW05514	1/4 (62AB-4 1362X4)	5	
NGA262D	5/16	5	
NGAW05134	3/8 (62AB-6 1362X6)	5	
NGAW15710	1/2 (62AB-8 1362X8)	5	
NGAW21826	5/8 (62AB-10 1362X10)	5	
NGAW16523	3/4 (62AB-12 1362X12)	5	

## AIR BRAKE 3/W UNION TEE

BRASS FITTING

Line: 371-00

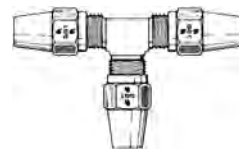

PART NO.	SIZE	QTY/BX	LIST PRICE
NHA264C	1/4 (264AB-4)	5	
NHA264DX	5/16	5	
NHAW05106	3/8 (264AB-6)	5	
NHAW15712	1/2 (264AB-8)	5	
NHA264H	5/8 (264AB-10)	5	
NHA264JX	3/4	5	

## AIR BRAKE UNION ELBOW

BRASS FITTING

Line: 372-00

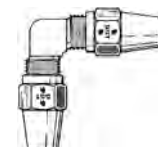

PART NO.	SIZE	QTY/BX	LIST PRICE
NJA265C	1/4 (264AB-4)	5	
NJAW05113	3/8 (265AB-6)	5	
NJAW22359	1/2 (265AB-8)	5	
NJAW22360	5/8 (265AB-10)	5	
NJA265J	3/4	5	

## AIR BRAKE MALE CONNECTOR

BRASS FITTING

Line: 375-00



PART NO.	SIZE	QTY/BX	LIST PRICE
NMAW05127	1/4 X 1/8 (VS68AB-42)	5	
NMAW05183	1/4 X 1/4 (VS68AB-44)	5	
NMA268CE	1/4 X 3/8 (VS68AB-4-6)	5	
NMA268DX	5/16 X 1/8	5	
NMA268DDX	5/16 X 1/4	5	
NMAW05509	3/8 X 1/8 (VS68AB-62)	5	
NMAW05053	3/8 X 1/4 (VS68AB-64)	5	
NMAW05824	3/8 X 3/8 (VS68AB-66)	5	
NMAW22063	3/8 X 1/2 (VS68AB-6-8)	5	
NMAW17525	1/2 X 3/8 (VS68AB-86)	5	
NMAW17690	1/2 X 1/4 (VS68AB-84)	5	
NMAW17691	1/2 X 1/2 (VS68AB-8-8)	5	
NMAW16685	5/8 X 3/8 (VS68AB-106)	5	
NMAW16684	5/8 X 1/2 (VS68AB-108)	5	
NMAW17621	3/4 X 1/2 (VS68AB-128)	5	
NMAW15762	3/4 X 3/4 (VS68AB1212)	5	

## AIR BRAKE MALE ELBOW

BRASS FITTING

Line: 376-00

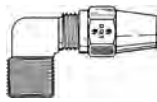

PART NO.	SIZE	QTY/BX	LIST PRICE
NNAW05539	1/4 X 1/8 (VS269AB-42)	5	
NNAW24318	1/4 X 1/4 (VS269AB-44)	5	
NNA269CEX	1/4 X 3/8 (VS269AB-46)	5	
NNA269DDX	5/16 X 1/4	5	
NNA269DFX	5/16 X 1/2	5	
NNA269DX	5/16 X 1/8	5	
NNAW05522	3/8 X 1/8 (VS269AB-62)	5	
NNAW05102	3/8 X 1/4 (VS269AB-64)	5	
NNAW05829	3/8 X 3/8 (VS269AB-66)	5	
NNAW22062	3/8 X 1/2 (VS269AB-68)	5	
NNAW20475	1/2 X 1/4 (VS269AB-84)	5	
NNAW15709	1/2 X 3/8 (VS269AB-86)	5	
NNAW16310	1/2 X 1/2 (VS269AB-88)	5	
NNAW21993	5/8 X 3/8 (VS269AB-106)	5	
NNAW21825	5/8 X 1/2 (VS269AB-108)	5	
NNA269J	3/4 X 1/2 (VS269AB-128)	5	
NNA269JJ	3/4 X 3/4	5	

## AIR BRAKE FEMALE CONNECTOR

BRASS FITTING

Line: 377-00



PART NO.	SIZE	QTY/BX	LIST PRICE
NPA266CC	1/4 X 1/4 (66AB-4-4)	5	
NPA266CX	1/4 X 1/8 (66AB-4-2)	5	
NPAW05418	3/8 X 1/8 (66AB-6-2)	5	
NPAW05826	3/8 X 1/4 (66AB-6-4)	5	
NPAW05827	3/8 X 3/8 (66AB-6-6)	5	
NPA266FCX	1/2 X 1/4	5	
NPAW15711	1/2 X 3/8 (66AB-8-6)	5	
NPA266FF	1/2 X 1/2 (66AB-8-8)	5	
NPA266HEX	5/8 X 3/8 (66AB-10-6)	5	
NPA266H	5/8 X 1/2 (66AB-10-8)	5	

## AIR BRAKE FEMALE ELBOW

BRASS FITTING

Line: 378-00

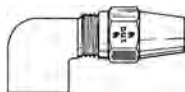

PART NO.	SIZE	QTY/BX	LIST PRICE
NRA270CX	1/4 X 1/8 (270AB-4-2)	5	
NRA270CC	1/4 X 1/4 (270AB-4-4)	5	
NRA270EX	3/8 X 1/8 (270AB-6-2)	5	
NRAW05135	3/8 X 1/4 (270AB-6-4)	5	
NRAW05830	3/8 X 3/8 (270AB-6-6)	5	
NRA270F	1/2 X 3/8 (270AB-8-6)	5	
NRA270FF	1/2 X 1/2 (270AB-8-8)	5	
NRA270HX	5/8 X 1/2 (270AB-10-8)	5	
NRA270JX	3/4 X 1/2	5	

## AIR BRAKE MALE 45° ELBOW

BRASS FITTING

Line: 379-00



PART NO.	SIZE	QTY/BX	LIST PRICE
NSA278C	1/4 X 1/8 (VS279AB-4-2)	5	
NSA278CC	1/4 X 1/4 (VS279AB-4-4)	5	
NSA278EX	3/8 X 1/8 (VS279AB-6-2)	5	
NSAW20722	3/8 X 1/4 (VS279AB-6-4)	5	
NSAW20291	3/8 X 3/8 (VS279AB-6-6)	5	
NSA279ABX6X8	3/8 X 1/2	5	
NSAW20292	1/2 X 3/8 (VS279AB-8-6)	5	
NSA278FF	1/2 X 1/2 (VS279AB-8-8)	5	
NSAW22065	5/8 X 1/2 (VS279AB-108)	5	
NSA279ABX12X8	3/4 X 1/2	5	

## AIR BRAKE 2/W BRANCH TEE

BRASS FITTING

Line: 380-00



PART NO.	SIZE	QTY/BX	LIST PRICE
NTA272C	1/4 X 1/8 (VS272AB-4-2)	5	
NTA272CC	1/4 X 1/4 (VS272AB-4-4)	5	
NTAW17051	3/8 X 1/8 (VS272AB-6-2)	5	
NTAW05103	3/8 X 1/4 (VS272AB-6-4)	5	
NTAW05177	3/8 X 3/8 (VS272AB-6-6)	5	
NTA272EF	3/8 X 1/2	5	
NTAW15700	1/2 X 3/8 (VS272AB-8-6)	5	
NTA272FF	1/2 X 1/2 (VS272AB-8-8)	5	
NTA272H	5/8 X 1/2 (VS272AB-108)	5	
NTA272J	3/4 X 1/2	5	

## AIR BRAKE 2/W RUN TEE

BRASS FITTING

Line: 381-00

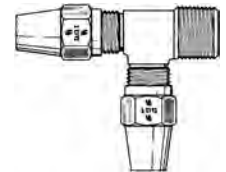

PART NO.	SIZE	QTY/BX	LIST PRICE
NUA271C	1/4 X 1/8 (VS271AB-42)	5	
NUA271CC	1/4 X 1/4 (VS271AB4-4)	5	
NUA271E	3/8 X 1/8	5	
NUAW05104	3/8 X 1/4 (VS271AB-64)	5	
NUAW17050	3/8 X 3/8 (VS271-6-6)	5	
NUAW15701	1/2 X 3/8 (VS271AB-86)	5	
NUA271FF	1/2 X 1/2	5	
NUA271H	5/8 X 1/2	5	
NUA271JX	3/4 X 1/2	5	



### IPT BULKHEAD COUPLING

STEEL FITTING

Line: 384-00

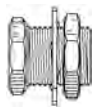

PART NO.	SIZE	QTY/BX	LIST PRICE
NYA1344	1/4 FPT X 1 1/2 BRASS	10	
NYA1351	1/2 FPT X 1 1/2 BRASS	2	
NYAW21204	1/4 X 15/16 (207ACBHS4)	5	
NYAW05465	1/4 X 1 1/2 (207ACBH4)	5	
NYAW17709	3/8 X 1 5/16	5	
NYAW05498	1/2 X 1/4 X 2 5/32	5	
NYAW05499	1/2 X 1/4 X 2 17/32	5	
NYAW05730	1/2 X 1/4 X 2 15/16	5	
NYAW23464	1/2 X 1/4 X 3 15/16	5	

### AIR COCK DRAINS

BRASS FITTING

Line: 385-00

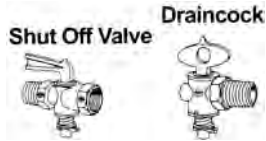

PART NO.	SIZE	QTY/BX	LIST PRICE
NZAW15310	1/4	5	
NZAW20332	1/4 X 1/4	5	

### AIR BRAKE HOSE BODY CONNECTOR

WITH NUT

Line: 385-02

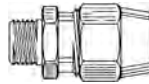

PART NO.	SIZE	QTY/BX	LIST PRICE
PAAW15540X	3/8 ID X 1/4 MPT (68RB64)	10	
PAAW24887	3/8 ID X 3/8 MPT (68RB66)	10	
PAAW15539X	3/8 ID X 1/2 MPT (68RB68)	10	
PAAW33883	1/2 ID X 3/8 MPT (68RB86)	10	
PAAW33884	1/2 ID X 1/2 MPT (68RB88)	5	

### AIR BRAKE HOSE BODY CONNECTOR

WITH SPRING NUT

Line: 385-03



PART NO.	SIZE	QTY/BX	LIST PRICE
PAAW15536X	3/8 ID X 1/4 MPT (68RBSG640)	5	
PAAW23907X	3/8 X 3/8 MPT (68RBSG66)	5	
PAAW15535	3/8 ID X 1/2 MPT (68RBSG68)	5	
PAAW33885	1/2 X 3/8 MPT (68RBSG86)	5	
PAAW33886	1/2 X 1/2 MPT (68RBSG88)	5	

### AIR BRAKE TRUCK HOSE BODY

BRASS FITTING

Line: 386-00

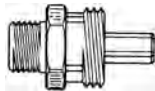

PART NO.	SIZE	QTY/BX	LIST PRICE
PAAW15993	3/8 X 1/4 MPT (68RB64B)	10	
PAAW33470	3/8 X 3/8 MPT (68RB66B)	10	
PAAW15992	3/8 X 1/2 MPT (68RB68B)	10	
PAAW33888	1/2 X 3/8 MPT (68RB86B)	10	
PAAW33889	1/2 X 1/2 MPT (68RB88B)	5	

### GLAD HAND COUPLER



Line: 386-02

PART NO.	SIZE	QTY/BX	LIST PRICE
WEAW14630	REG GLADHAND SEAL	5	
WEAW75150	UNIVERSAL	1	
WEAW76150	UNIVERSAL ALL HOOKUP	5	
WEAW78850	SERVICE	1	
WEAW78851	EMERGENCY	1	

### AIR BRAKE GLAD HAND SEAL



Line: 386-03

PART NO.	SIZE	QTY/BX	LIST PRICE
WEAW13630	WEATHERHEAD	25	
WEA2529J	BENDIX	25	

### AIR BRAKE H338 TRK HOSE CONN

W/ ADAPTER

Line: 386-04



PART NO.	SIZE	QTY/BX	LIST PRICE
WEAW26293	3/8 X 3/8 X 1/4	5	
WEAW33808	3/8 X 3/8 X 3/8	5	
WEAW33882X	1/2 X 1/2 X 3/8	5	

### AIR BRAKE H338 TRK HOSE CONN

Line: 386-05

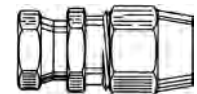

PART NO.	SIZE	QTY/BX	LIST PRICE
WEAW26292	3/8 H X 3/4-20	5	
WEAW33881	1/2 H X 7/8-20	5	

### AIR BRAKE H338 ADAPTER

Line: 386-08



PART NO.	SIZE	QTY/BX	LIST PRICE
WEAW02687	3/8 X 1/4	5	
WEAW33807	3/8 X 3/8	5	
WEAW33805X	1/2 X 3/8	5	
WEAW33806X	1/2 X 1/2	5	

### AIR BRAKE TRUCK HOSE SLEEVE

BRASS FITTING

Line: 387-00



PART NO.	SIZE	QTY/BX	LIST PRICE
PBAW03610	3/8 ID H	10	
PBAW33801	1/2 ID H	10	

## AIR BRAKE TRUCK HOSE NUT



Line: 388-00

PART NO.	SIZE	QTY/BX	LIST PRICE
PCAW03624	3/8	10	
PCAW33802	1/2	10	

## AIR BRAKE TRUCK HOSE SPRING NUT



Line: 389-00

PART NO.	SIZE	QTY/BX	LIST PRICE
PDA36131045	3/8	5	
PDA3380333804	1/2 ID H	5	

## AIR BRAKE TRUCK HOSE SPRING NUT



Line: 389-01

PART NO.	SIZE	QTY/BX	LIST PRICE
PDAW01045	3/8 ID SPRING (56RBSG-6)	5	
PDAW03613	3/8 ID NUT (61RBSG-6)	5	
PDAW33803	1/2 ID NUT (61RBSG-8)	5	
PDAW33804	1/2 ID SPRING (56RBSG8)	5	

## AIR BRAKE TRUCK HOSE MENDER

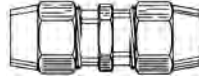

Line: 390-00

PART NO.	SIZE	QTY/BX	LIST PRICE
PEAW16678	3/8 (62RB6/33806BY06)	5	
PEAW33887	1/2 (62RB8/33808BY08)	5	

## J844 TRUCK TUBING SLEEVE

BRASS FITTINGS



Line: 391-00

PART NO.	SIZE	QTY/BX	LIST PRICE
PFA60TF2	1/8 TRANS FITT	10	
PFA60TF532	5/32 TRANS FITT	10	
PFA1460X4	1/4 (60NTA-4)	10	
PFA1460X6	3/8 (60NTA-6)	10	
PFA1460X8	1/2 (60NTA-8)	10	
PFA1460X10	5/8 (60NTA-10)	10	
PFA1460X12	3/4 (60NTA-12)	10	

## J844 TRUCK TUBING NUT

BRASS FITTINGS



Line: 392-00

PART NO.	SIZE	QTY/BX	LIST PRICE
PGA61TF2	1/8 (TRANS FITT)	10	
PGA61TF532	5/32 (TRANS FITT)	10	
PGA1461X4	1/4 (61NTA-4)	5	
PGA1461X6	3/8 (61NTA-6)	5	
PGA1461X8	1/2 (61NTA-8)	5	
PGA1461X10	5/8 (61NTA-10)	5	
PGA1461X12	3/4 (61NTA-12)	5	

## J844 TRUCK TUBING UNION



Line: 393-00

PART NO.	SIZE	QTY/BX	LIST PRICE
PHA62TF2	1/8 (TRANS FITT)	5	
PHA62TF532	5/32 (TRANS FITT)	5	
PHA1462X4	1/4 (62NTA-4)	5	
PHA1462X6	3/8 (62NTA-6)	5	
PHA1462X8	1/2 (62NTA-8)	5	
PHA1462X10	5/8 (62NTA-10)	5	
PHA1462X12	3/4 (62NTA-12)	5	

## J844 TRUCK TUBING UNION ELBOW



Line: 394-00

PART NO.	SIZE	QTY/BX	LIST PRICE
PJA1465X4	1/4 (265NTA-4)	5	
PJA1465X6	3/8 (265NTA-6)	5	
PJA1465X8	1/2 (265NTA-8)	5	
PJA1465X10	5/8 (265NTA-10)	5	

## J844 BULKHEAD UNION



Line: 395-00

PART NO.	SIZE	QTY/BX	LIST PRICE
PKA1474X4	1/4	5	
PKA1474X6	3/8 (62NBH-6)	5	
PKA1474X8	1/2 (62NBH-8)	5	
PKA1474X10	5/8	5	

## J844 TRUCK TUBING INSERTS

BRASS & STAINLESS



Line: 396-00

PART NO.	SIZE	QTY/BX	LIST PRICE
PLA1484X4	1/4 (63NTA-4)	25	
PLA1484X4SS	1/4 (63NTA-4 ST/ST)	25	
PLA1484X6	3/8 (63NTA-6)	25	
PLA1484X6SS	3/8 (63NTA-6 ST/ST)	25	
PLA1484X8	1/2 (63NTA-8)	10	
PLA1484X10SS	5/8 (63NTA-10 ST/ST)	10	
PLA1484X10	5/8 (BRASS PRESS-FIT)	10	
PLA1484X12	3/4 (63NTA-12)	10	

### J844 TRUCK TUBING UNION TEE

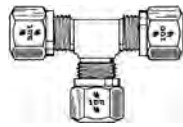

Line: 397-00

PART NO.	SIZE	QTY/BX	LIST PRICE
PMA1464X4	1/4 (264NTA-4)	5	
PMA1464X4X6	1/4 X 3/8 X 3/8	5	
PMA1464X6	3/8 (264NTA-6)	5	
PMA1464X644	3/8 X 3/8 X 1/4	5	
PMA1464X6X8	3/8 X 3/8 X 1/2	5	
PMA1464X8	1/2 (264NTA-8)	5	
PMA1464X10	5/8 (264NTA-10)	5	

### J844 TRUCK TUBING FEMALE CONN

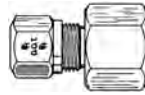

Line: 398-00

PART NO.	SIZE	QTY/BX	LIST PRICE
PNA1466X4	1/4 X 1/8 (66NTA-4-2)	5	
PNA1466X4X4	1/4 X 1/4 (66NTA-4-4)	5	
PNA1466X6X2	3/8 X 1/8 (66NTA-6-2)	5	
PNA1466X6	3/8 X 1/4 (66NTA-6-4)	5	
PNA1466X6X6	3/8 X 3/8 (66NTA-6-6)	5	
PNA1466X8	1/2 X 3/8 (66NTA-8-6)	5	
PNA1466X8X8	1/2 X 1/2 (66NTA-8-8)	5	
PNA1466X10X6	5/8 X 3/8	5	
PNA1466X10	5/8 X 1/2 (66NTA-10-8)	5	

### J844 TRUCK TUBING FEMALE ELBOW

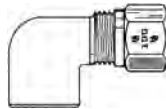

Line: 399-00

PART NO.	SIZE	QTY/BX	LIST PRICE
PPA1470X4	1/4 X 1/8 (270NTA-4-2)	5	
PPA1470X4X4	1/4 X 1/4	5	
PPA1470X6X2	3/8 X 1/8 (270NTA-6-2)	5	
PPA1470X6	3/8 X 1/4 (270NTA-6-4)	5	
PPA1470X6X6	3/8 X 3/8 (270NTA-6-6)	5	
PPA1470X8	1/2 X 3/8 (270NTA-8-6)	5	
PPA1470X8X8	1/2 X 1/2	5	
PPA1470X10	5/8 X 1/2 (270NTA108)	5	

### J844 TRUCK TUBING MALE RUN TEE

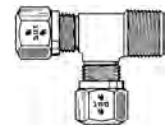

Line: 400-00

PART NO.	SIZE	QTY/BX	LIST PRICE
PRA1471X4	1/4 X 1/8 (VS271NTA42)	5	
PRA1471X6	3/8 X 1/4 (VS271NTA64)	5	
PRA1471X644	3/8 X 1/4 X 1/4	5	
PRA1471X666	3/8 X 3/8 (VS271NTA66)	5	
PRA1471X8	1/2 X 3/8 (VS271NTA86)	5	
PRA1471X10	5/8 X 1/2 (VS271NTA10-8)	5	

### J844 TRUCK TUBING FEMALE BRANCH TEE

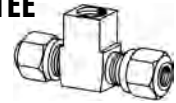

Line: 401-00

PART NO.	SIZE	QTY/BX	LIST PRICE
PSA1477X6	3/8 X 1/4	5	
PSA1477X8X8X4	1/2 X 1/4	5	
PSA1477X10X4	5/8 X 1/4	5	

### J844 TRUCK TUBING ADAPTER TEE

BRASS FITTINGS

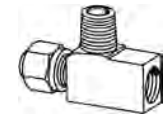

Line: 402-00

PART NO.	SIZE	QTY/BX	LIST PRICE
PTA1482X644	3/8 X 1/4 X 1/4	5	
PTA1482X646	3/8 X 1/4 X 3/8	5	
PTA1482X10X48	5/8 X 1/4 X 1/2	5	

### J844 TRUCK TUBING MALE BRANCH TEE

BRASS FITTINGS

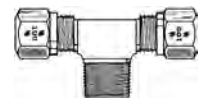

Line: 404-00

PART NO.	SIZE	QTY/BX	LIST PRICE
PVA1472X4	1/4 X 1/8 (VS272NTA4-2)	5	
PVA1472X662	3/8 X 1/8 (VS272NTA6-2)	5	
PVA1472X6	3/8 X 1/4 (VS272NTA6-4)	5	
PVA1472X644	3/8 X 1/4 X 1/4	5	
PVA1472X666	3/8 X 3/8 (VS272NTA6-6)	5	
PVA1472X884	1/2 X 1/4 (VS272NTA8-4)	5	
PVA1472X8	1/2 X 3/8 (VS272NTA8-6)	5	
PVA1472X866	1/2 X 3/8 X 3/8	5	
PVA1472X10104	5/8 X 1/4	5	
PVA1472X10	5/8 X 1/2 (VS272NTA108)	5	

## J844 TRUCK TUBING MALE CONNECTOR



Line: 405-00

PART NO.	SIZE	QTY/BX	LIST PRICE
PWA68TF21	1/8 X 1/16 (TRANS FIT)	5	
PWA68TF22	1/8 X 1/8 (TRANS FIT)	5	
PWA68TF5321	5/32 X 1/16 (TRANS FIT)	5	
PWA68TF5322	5/32 X 1/8 (TRANS FIT)	5	
PWA1468X4	1/4 X 1/8 (VS68NTA-4-2)	5	
PWA1468X4X4	1/4 X 1/4 (VS68NTA-4-4)	5	
PWA1468X4X6	1/4 X 3/8 (VS68NTA-4-6)	5	
PWA1468X6X2	3/8 X 1/8 (VS68NTA-6-2)	5	
PWA1468X6	3/8 X 1/4 (VS68NTA-6-4)	5	
PWA1468X6X6	3/8 X 3/8 (VS68NTA-6-6)	5	
PWA1468X6X8	3/8 X 1/2 (VS68NTA-6-8)	5	
PWA1468X8X4	1/2 X 1/4 (VS68NTA-8-4)	5	
PWA1468X8	1/2 X 3/8 (VS68NTA-8-6)	5	
PWA1468X8X12	1/2 X 3/4 (VS68NTA8-12)	5	
PWA1468X8X8	1/2 X 1/2 (VS68NTA-8-8)	5	
PWA1468X10	5/8 X 1/2 (VS68NTA10-8)	5	
PWA1468X10X6	5/8 X 3/8 (VS68NTA10-6)	5	
PWA1468X1012	5/8 X 3/4	5	
PWA1468X12	3/4 X 1/2 (VS68NTA12-8)	5	
PWA1468X1212	3/4 X 3/4	5	

## J844 TRUCK TUBING MALE ELBOW



Line: 406-00

PART NO.	SIZE	QTY/BX	LIST PRICE
PXA269TF22	1/8 X 1/8 (TRANS FIT)	5	
PXA269TF5322	5/32 X 1/8 (TRANS FIT)	5	
PXA1469X4	1/4 X 1/8 (VS269NTA4-2)	5	
PXA1469X4X4	1/4 X 1/4 (VS269NTA4-4)	5	
PXA1469X4X6	1/4 X 3/8 (VS269NTA4-6)	5	
PXA1469X6X2	3/8 X 1/8 (VS269NTA6-2)	5	
PXA1469X6	3/8 X 1/4 (VS269NTA6-4)	5	
PXA1469X6X6	3/8 X 3/8 (VS269NTA6-6)	5	
PXA1469X6X8	3/8 X 1/2 (VS269NTA6-8)	5	
PXA1469X8X4	1/2 X 1/4 (VS269NTA8-4)	5	
PXA1469X8	1/2 X 3/8 (VS269NTA8-6)	5	
PXA1469X8L	1/2 X 3/8 (LONG)	5	
PXA1469X8X8	1/2 X 1/2 (VS269NTA8-8)	5	
PXA1469X10	5/8 X 1/2 (VS269NTA108)	5	
PXA1469X10X6	5/8 X 3/8 (VS269NTA106)	5	
PXA1469X1012	5/8 X 3/4	5	
PXA1469X12	3/4 X 1/2 (VS269NTA128)	5	
PXA1469X12X12	3/4 X 3/4	5	
PXA1469X12X6	3/4 X 3/8	5	

## J844 TRUCK TUBING 45° MALE ELBOW

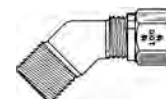

Line: 407-00

PART NO.	SIZE	QTY/BX	LIST PRICE
PYA1480X4	1/4 X 1/8 (VS279NTA4-2)	5	
PYA1480X4X4	1/4 X 1/4 (VS279NTA-4)	5	
PYA1480X6X2	3/8 X 1/8 (VS279NTA6-2)	5	
PYA1480X6	3/8 X 1/4 (VS279NTA6-4)	5	
PYA1480X6X6	3/8 X 3/8 (VS279NTA6-6)	5	
PYA1480X6X8	3/8 X 1/2 (VS279NTA6-8)	5	
PYA1480X8X4	1/2 X 1/4 (VS279NTA8-4)	5	
PYA1480X8	1/2 X 3/8 (VS279NTA8-6)	5	
PYA1480X8X8	1/2 X 1/2 (VS279NTA8-8)	5	
PYA279NTAX106	5/8 X 3/8	5	
PYA1480X10	5/8 X 1/2 (VS279NTA108)	5	
PYA1480X12	3/4 X 1/2	5	

## INVERTED FLARE NUT

BRASS

Line: 408-00



PART NO.	SIZE	QTY/BX	LIST PRICE
PZA105A	1/8 (411F-2)	10	
PZA100X3	3/16 (411F-3)	10	
PZA100X4	1/4 (411F-4)	10	
PZA100X5	5/16 (411F-5)	10	
PZA100X6	3/8 (411F-6)	10	
PZA100X8	1/2 (411F-8)	10	
PZA105H	5/8 (411F-10)	5	

## INVERTED FLARE NUT

STEEL

Line: 409-00

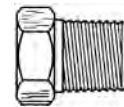

PART NO.	SIZE	QTY/BX	LIST PRICE
RAA105X2	1/8 (411FS-2)	10	
RAA105X3	3/16 (411FS-3)	10	
RAA105X4	1/4 (411FS-4)	10	
RAA105X5	5/16 (411FS-5)	10	
RAA105X6	3/8 (411FS-6)	10	
RAA105X7	7/16	10	
RAA105X8	1/2 (411FS-8)	10	
RAA105X10	5/8 (411FS-10)	5	
RAA105X12	3/4 (411FS-12)	5	
RAA105X14X	7/8	5	
RAA105X16	1	5	

### INVERTED FLARE STEEL LONG NUT

Line: 410-00

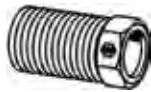

PART NO.	SIZE	QTY/BX	LIST PRICE
RBA7896X3	3/16	5	
RBA7896X4	1/4	5	

### INVERTED FLARE UNION

BRASS

Line: 411-00

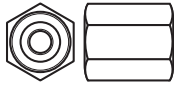

PART NO.	SIZE	QTY/BX	LIST PRICE
RCA302X2	1/8 (421FD-2)	5	
RCA302X3	3/16 (421FD-3)	5	
RCA302X4	1/4 (421FD-4)	5	
RCA302X5	5/16 (421FD-5)	5	
RCA302X6	3/8 (421FD-6)	5	
RCA302X8	1/2 (421FD-8)	5	
RCA302X10	5/8	5	

### INVERTED FLARE UNION ELBOW

Line: 412-00

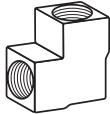

PART NO.	SIZE	QTY/BX	LIST PRICE
RDA502X4	1/4 (2551FHD-4)	5	
RDA502X6X	3/8	5	
RDA502X8	1/2	5	

### INVERTED FLARE UNION TEE

BRASS

Line: 413-00

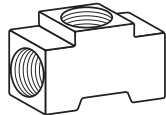

PART NO.	SIZE	QTY/BX	LIST PRICE
REA702X2	1/8	5	
REA702X3	3/16 (2441FHD-3)	5	
REA702X4	1/4 (2441FHD-4)	5	
REA702X5	5/16 (2441FHD-5)	5	
REA702X6	3/8 (2441FHD-6)	5	
REA702X8	1/2 (2441FHD-8)	5	

### INVERTED FLARE STEEL PLUG

Line: 414-00

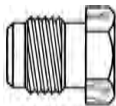

PART NO.	SIZE	QTY/BX	LIST PRICE
RFA131X3	3/16	5	
RFA131X4	1/4	5	
RFA131X5	5/16	5	
RFA131X6	3/8	5	

### INVERTED FLARE MALE CONNECTOR

BRASS

Line: 415-00

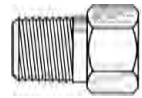

PART NO.	SIZE	QTY/BX	LIST PRICE
RGA202X2	1/8 X 1/8 (4811FHD-2-2)	5	
RGA202X3	3/16 X 1/8 (4811FHD3-2)	5	
RGA202X4	1/4 X 1/8 (4811FHD-4-2)	5	
RGA202X4X4	1/4 X 1/4 (4811FHD-4-4)	5	
RGA202X5	5/16 X 1/8 (4811FHD5-2)	5	
RGA202X5X4	5/16 X 1/4 (4811FHD5-4)	5	
RGA202X6	3/8 X 1/4 (4811FHD-6-4)	5	
RGA202X6X2	3/8 X 1/8 (4811FHD-6-2)	5	
RGA202X6X6	3/8 X 3/8 (4811FHD-6-6)	5	
RGA202X7	7/16 X 1/4	5	
RGA202X8	1/2 X 3/8 (4811FHD-8-6)	5	
RGA202X8X4	1/2 X 1/4	5	
RGA202X8X8	1/2 X 1/2	5	
RGA202X10	5/8 X 1/2 (4811FHD10-8)	5	
RGA202X12	3/4 X 3/4	5	
RGA202X12X8	3/4 X 1/2	5	

### INVERTED FLARE MALE ELBOW

BRASS

Line: 416-00

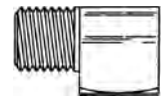

PART NO.	SIZE	QTY/BX	LIST PRICE
RHA402X2	1/8 X 1/8 (2491FHD-2-2)	5	
RHA402X3	3/16 X 1/8 (2491FHD3-2)	5	
RHA402X4	1/4 X 1/8 (2491FHD-4-2)	5	
RHA402X4X4	1/4 X 1/4 (2491FHD-4-4)	5	
RHA431X4	1/4 X 1/8 RESTRICT	5	
RHA402X5	5/16 X 1/8 (2491FHD5-2)	5	
RHA402X5X4	5/16 X 1/4 (2491FHD5-4)	5	
RHA402X5X6	5/16 X 3/8	5	
RHA402X6	3/8 X 1/4 (2491FHD-6-4)	5	
RHA402X6X2	3/8 X 1/8 (2491FHD-6-2)	5	
RHA402X6X6	3/8 X 3/8 (2491FHD-6-6)	5	
RHA402X7	7/16 X 1/4	5	
RHA402X8	1/2 X 3/8 (2491FHD-8-6)	5	
RHA402X8X4	1/2 X 1/4 (2491FHD-8-4)	5	
RHA402X8X8	1/2 X 1/2 (2491FHD-8-8)	5	
RHA402X10	5/8 X 1/2 (2491FHD10-8)	5	
RHA402X10X6	5/8 X 3/8	5	
RHA402X12	3/4 X 3/4	5	
RHA402X12X8	3/4 X 1/2	5	
RHA402X14	7/8 X 3/4	5	
RHA402X16	1 X 1	5	

## INVERTED FLARE FEMALE CONNECTOR

BRASS

Line: 417-00



PART NO.	SIZE	QTY/BX	LIST PRICE
RJA252X3	3/16 X 1/8 (461FHD-3-2)	5	
RJA252X4	1/4 X 1/8 (461FHD-4-2)	5	
RJA252X5	5/16 X 1/8 (461FHD-5-2)	5	
RJA252X6	3/8 X 1/4 (461FHD-6-4)	5	
RJA252X7	7/16 X 1/4	5	
RJA252X8	1/2 X 3/8 (461FHD-8-6)	5	
RJA252X10	5/8 X 1/2	5	
RJA252X12	3/4 X 3/4	5	

## INVERTED FLARE MALE 45 ELBOW

BRASS

Line: 418-00

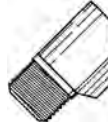

PART NO.	SIZE	QTY/BX	LIST PRICE
RKA352X2	1/8 X 1/8	5	
RKA352X3	3/16 X 1/8 (259IFHD3-2)	5	
RKA352X4	1/4 X 1/8 (259IFHD-4-2)	5	
RKA352X5	5/16 X 1/8 (259IFHD5-2)	5	
RKA352X5X4	5/16 X 1/4 (259IFHD5-4)	5	
RKA352X6	3/8 X 1/4 (259IFHD-6-4)	5	
RKA352X8	1/2 X 3/8	5	
RKA352X10	5/8 X 1/2	5	

## INVERTED FLARE FEMALE ELBOW

BRASS

Line: 419-00



PART NO.	SIZE	QTY/BX	LIST PRICE
RLA452X3	3/16 X 1/8	5	
RLA452X4	1/4 X 1/8 (250IFHD-4-2)	5	
RLA452X5	5/16 X 1/8 (250IFHD5-2)	5	
RLA452X6	3/8 X 1/4 (250IFHD-6-4)	5	
RLA452X8	1/2 X 3/8	5	
RLA452X10	5/8 X 1/2	5	

## INVERTED FLARE MALE BRANCH TEE

BRASS

Line: 420-00

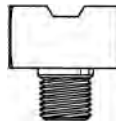

PART NO.	SIZE	QTY/BX	LIST PRICE
RMA602X3	3/16 X 1/8	5	
RMA602X4	1/4 X 1/8 (245IFHD-4-2)	5	
RMA602X5	5/16 X 1/8	5	
RMA602X6	3/8 X 1/4 (245IFHD-6-4)	5	
RMA602X8	1/2 X 3/8	5	

## INVERTED FLARE FEMALE BRANCH TEE

BRASS

Line: 421-00



PART NO.	SIZE	QTY/BX	LIST PRICE
RNA652X3	3/16 X 1/8	5	
RNA652X4	1/4 X 1/8	5	
RNA652X5	5/16 X 1/8	5	
RNA652X6	3/8 X 1/4	5	

## INVERTED FLARE MALE RUN TEE

BRASS

Line: 422-00

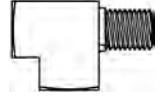

PART NO.	SIZE	QTY/BX	LIST PRICE
RPA752X3	3/16 X 1/8	5	
RPA752X4	1/4 X 1/8	5	
RPA752X5	5/16 X 1/8	5	
RPA752X6	3/8 X 1/4	5	
RPA752X8	1/2 X 3/8	5	

## INVERTED FLARE ADAPTER TEE

BRASS

Line: 423-00



PART NO.	SIZE	QTY/BX	LIST PRICE
RRA552X3	3/16 X 1/8	5	
RRA552X4	1/4 X 1/8	5	

### INVERTED FLARE ADAPTER CONN

BRASS  
Line: 424-00

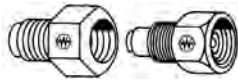

PART NO.	SIZE	QTY/BX	LIST PRICE
RSA1441	IF 3/16 X 3/8-24	5	
RSA7912	IF 3/16 X 1/2-20	5	
RSA7913	IF 3/16 X 9/16-18	5	
RSA7916	IF 3/16 X 1/4 X 5/8-18	5	
RSA7817	3/16 X 1/2-20	5	
RSA7818	IF 3/16 X 1/4	5	
RSA7897	IF 3/16 X 5/16	5	
RSA7910	3/16 X 9/16-20	5	
RSA7911	3/16 X 9/16-18	5	
RSA7727	1/4 X 1/2-20	5	
RSA7732	1/4 X 7/16-20	5	
RSA7828	IF 1/4 X 3/16	5	
RSA7829	IF 1/4 X 5/16	5	
RSA7908	1/4 X 9/16-18	5	
RSA1074	5/16 X 1/2-20	5	
RSA7771	5/16 X 3/8 MP	5	
RSA7915	IF 3/8 X 5/16 IF ML	5	
RSA7940	3/8-24 BRIT UNION	5	
RSA7917	1/2-20 X 7/16-24	5	

### INVERTED FLARE BRAKE FITTING TEE

BRASS  
Line: 425-00

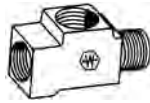

PART NO.	SIZE	QTY/BX	LIST PRICE
HSD7830	IF 3/16 X 5/16 X 1/8	5	
HSD7933	IF 3/16 X 9/16-18	5	
HSD7900	3/16 X 3/16	5	
HSD7907	3/16 X 7/16-20	5	
HSD7765X	1/4-IF 3/WAY W/BACKET	5	
HSD7898	1/4 X 1/4	5	
HSD7901	1/4 X 3/16	5	
HSD7914	7/16-24 X 3/16	5	

### BRASS PIPE THREAD ADAPTER

Line: 426-00

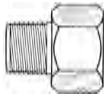

PART NO.	SIZE	QTY/BX	LIST PRICE
SFA3200X2	1/8 (222P-2-2)	5	
SFA3200X4	1/4 (222P-4-4)	5	
RTA3200X42	1/4 X 1/8 (222P-4-2)	5	
SFA3200X6	3/8 (222P-6-6)	5	
RTA120REA	3/8 X 1/8	5	
RTA3200X64	3/8 X 1/4 (222P-6-4)	5	
SFA120F	1/2 (222P-8-8)	5	
RTA120RFC	1/2 X 1/4	5	
RTA3200X86	1/2 X 3/8 (222P-8-6)	5	
RTA120RJF	3/4 X 1/2	5	

### BRASS PIPE THREAD BUSHING

Line: 427-00

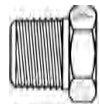

PART NO.	SIZE	QTY/BX	LIST PRICE
RUA3220X42	1/4 X 1/8 (209P-4-2)	5	
RUA3220X62	3/8 X 1/8 (209P-6-2)	5	
RUA3220X64	3/8 X 1/4 (209P-6-4)	5	
RUA3220X82	1/2 X 1/8 (209P-8-2)	5	
RUA3220X84	1/2 X 1/4 (209P-8-4)	5	
RUA3220X86	1/2 X 3/8 (209P-8-6)	5	
RUA110JA	3/4 X 1/8 (209P-12-2)	5	
RUA110JC	3/4 X 1/4 (209P-12-4)	5	
RUA3220X126	3/4 X 3/8 (209-12-6)	5	
RUA3220X128	3/4 X 1/2 (209P-12-8)	5	
RUA110NC	1 X 1/4	5	
RUA110NE	1 X 3/8	5	
RUA110NF	1 X 1/2	5	
RUA110NJ	1 X 3/4	5	

### BRASS PIPE THREAD REDUCING COUPLING

Line: 428-00

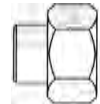

PART NO.	SIZE	QTY/BX	LIST PRICE
RVA3300X42	1/4 X 1/8 (208P-4-2)	5	
RVA3300X62	3/8 X 1/8	5	
RVA3300X64	3/8 X 1/4 (208P-6-4)	5	
RVA3300X82X	1/2 X 1/8	5	
RVA119FC	1/2 X 1/4 (208P-8-4)	5	
RVA3300X86	1/2 X 3/8 (208P-8-6)	5	
RVA119JC	3/4 X 1/4	5	
RVA119JE	3/4 X 3/8	5	
RVA119J	3/4 X 1/2	5	
RVA119NJ	1 X 3/4	5	

### BRASS PIPE THREAD REDUCING NIPPLE

Line: 429-00

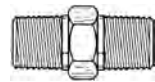

PART NO.	SIZE	QTY/BX	LIST PRICE
RWA3325X42	1/4 X 1/8 (216P-4-2)	5	
RWA3325X62	3/8 X 1/8 (216P-6-2)	5	
RWA3325X64	3/8 X 1/4 (216P-6-4)	5	
RWA112RFC	1/2 X 1/4	5	
RWA112RFE	1/2 X 3/8 (216P-8-6)	5	
RWA112RJF	3/4 X 1/2	5	

## IPT REDUCING STREET ELBOW

BRASS FITTING

Line: 430-00

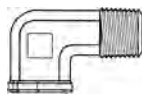

PART NO.	SIZE	QTY/BX	LIST PRICE
RXA116HCA	1/4 M X 1/8 F	5	
RXA3400X42	1/4 X 1/8 (2202P4-2)	5	
RXA116SCE	3/8 FX 1/4 M	5	

## IPT REDUCING FEMALE ELBOW

BRASS FITTING

Line: 431-00



PART NO.	SIZE	QTY/BX	LIST PRICE
RYA100EC	3/8 X 1/4	5	
RYA100FE	1/2 X 3/8	5	

## IPT SLOTTED PLUG

BRASS FITTING

Line: 432-00



PART NO.	SIZE	QTY/BX	LIST PRICE
RZA3150X2	1/8 (220P-2)	5	
RZA3150X4	1/4 (220P-4)	5	
RZA109WE	3/8 (220P-6)	5	

## BRASS PIPE THREAD SQUARE PIPE PLUG

Line: 433-00

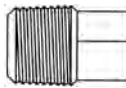

PART NO.	SIZE	QTY/BX	LIST PRICE
SAA3151X2	1/8 (211P-2)	5	
SAA3151X4	1/4 (211P-4)	5	
SAA3151X6	3/8 (211P-6)	5	
SAA3151X8	1/2 (211P-8)	5	
SAA3151X12	3/4 (211P-12)	5	

## BRASS PIPE THREAD HEX PLUG

Line: 434-00

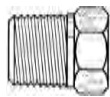

PART NO.	SIZE	QTY/BX	LIST PRICE
SBA3152X2	1/8 (218P-2)	5	
SBA3152X4	1/4 (218P-4)	5	
SBA3152X6	3/8 (218P-6)	5	
SBA3152X8	1/2 (218P-8)	5	
SBA3152X12	3/4	5	
SBA109XN	1	5	

## IPT HEX RECESSED PLUG

BRASS FITTING

Line: 436-00



PART NO.	SIZE	QTY/BX	LIST PRICE
SDA109UA	1/8 (219P-2)	5	
SDA109UC	1/4 (219P-4)	5	
SDA109UE	3/8 (219P-6)	5	
SDA109UF	1/2 (219P-8)	5	

## BRASS PIPE THREAD PIPE CAP

Line: 437-00



PART NO.	SIZE	QTY/BX	LIST PRICE
SEA3129X2	1/8 (213P-2)	5	
SEA3129X4	1/4 (213P-4)	5	
SEA108E	3/8 (213P-6)	5	
SEA108F	1/2 (213P-8)	5	
SEA108J	3/4	5	
SEA108N	1	5	

## IPT UNION

Line: 439-00

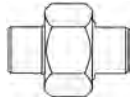

PART NO.	SIZE	QTY/BX	LIST PRICE
SGA3250X2	1/8	5	
SGA3250X4	1/4 (212P-4)	5	
SGA104E	3/8 (212P-6)	5	
SGA104F	1/2	5	
SGA104J	3/4	5	
SGA104N	1	5	

## PIPE THREAD PIPE COUPLING

Line: 440-00

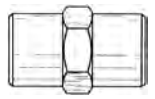

PART NO.	SIZE	QTY/BX	LIST PRICE
SHA3300X2	1/8 (207P-2)	5	
SHA3300X4	1/4 (207P-4)	5	
SHA3300X6	3/8 (207P-6)	5	
SHA3300X8	1/2 (207P-8)	5	
SHA3300X12	3/4	5	
SHA103N	1	5	

## BRASS PIPE THREAD HEX NIPPLE

Line: 441-00

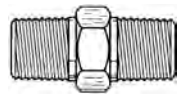

PART NO.	SIZE	QTY/BX	LIST PRICE
SJA3325X2	1/8 (216P-2)	5	
SJA3325X4	1/4 (216P-4)	5	
SJA3325X6	3/8 (216P-6)	5	
SJA3325X8	1/2 (216P-8)	5	
SJA3325X12	3/4	5	
SJA112XN	1	5	



### BRASS PIPE THREAD CLOSE NIPPLE

Line: 442-00

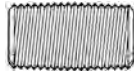

PART NO.	SIZE	QTY/BX	LIST PRICE
SKA3326X2	1/8 (215PN-2)	5	
SKA3326X4	1/4 (215PN-4)	5	
SKA3326X6	3/8 (215PN-6)	5	
SKA3326X8	1/2 (215PN-8)	5	
SKA3326X12	3/4 (215PN-12)	5	
SKA112N	1	5	

### BRASS PIPE THREAD 45° STREET ELBOW

Line: 443-00



PART NO.	SIZE	QTY/BX	LIST PRICE
SLA3350X2	1/8 (2214P-2-2)	5	
SLA3350X4	1/4 (2214P-4-4)	5	
SLA3350X6	3/8 (2214P-6-6)	5	
SLA3350X8	1/2 (2214P-8-8)	5	
SLA3350X12	3/4	5	

### BRASS PIPE THREAD 90° STREET ELBOW

Line: 444-00

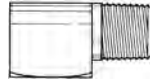

PART NO.	SIZE	QTY/BX	LIST PRICE
SMA3400X2	1/8 (2202P-2-2)	5	
SMA3400X4	1/4 (2202P-4-4)	5	
SMA3400X6	3/8 (2202P-6-6)	5	
SMA3400X8	1/2 (2202P-8-8)	5	
SMA3400X12	3/4	5	
SMA116N	1	5	

### BRASS PIPE THREAD 90° FEMALE ELBOW

Line: 445-00

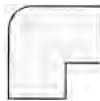

PART NO.	SIZE	QTY/BX	LIST PRICE
SNA3500X2	1/8 (2200P-2-2)	5	
SNA3500X4	1/4 (2200P-4-4)	5	
SNA3500X6	3/8 (2200P-6-6)	5	
SNA3500X8	1/2 (2200P-8-8)	5	
SNA3500X12	3/4	5	
SNA100N	1	5	

### IPT MALE BRANCH TEE

Line: 446-00



PART NO.	SIZE	QTY/BX	LIST PRICE
SPA3600X2	1/8 (2224P-2)	5	
SPA3600X4	1/4 (2224P-4)	5	
SPA3600X6	3/8 (2224P-6)	5	
SPA3600X8	1/2 (2224P-8)	5	
SPA3600X12	3/4	5	

### BRASS PIPE THREAD TEE

Line: 447-00

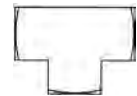

PART NO.	SIZE	QTY/BX	LIST PRICE
SRA3700X2	1/8 (2203P-2)	5	
SRA3700X4	1/4 (2203P-4)	5	
SRA3700X6	3/8 (2203P-6)	5	
SRA3700X8	1/2 (2203P-8)	5	
SRA3700X12	3/4	5	

### BRASS PIPE THREAD STREET TEE

BRASS FITTING

Line: 448-00

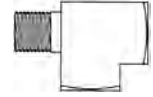

PART NO.	SIZE	QTY/BX	LIST PRICE
SSA3750X2	1/8 (2225P-2)	5	
SSA3750X4	1/4 (2225P-4)	5	
SSA3750X6	3/8 (2225P-6)	5	
SSA3750X8	1/2 (2225P-8)	5	
SSA3750X12	3/4	5	

### IPT CROSS

Line: 449-00

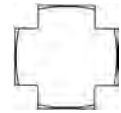

PART NO.	SIZE	QTY/BX	LIST PRICE
STA3950X2	1/8 (2205P-2)	5	
STA3950X4	1/4 (2205P-4)	5	
STA3950X6	3/8 (2205P-6)	5	
STA3950X8	1/2	5	
STA3950X12	3/4	5	

### IPT MALE ELBOW

Line: 450-00

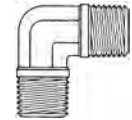

PART NO.	SIZE	QTY/BX	LIST PRICE
SUA130A	1/8	5	
SUA130C	1/4	5	
SUA130CAX	1/4 X 1/8 IPT REDUCING	5	
SUA130E	3/8	5	
SUA130EC	3/8 X 1/4	5	
SUA130F	1/2	5	

### IPT LOCK NUT

Line: 451-00



PART NO.	SIZE	QTY/BX	LIST PRICE
SVA111A	1/8	5	
SVA111C	1/4	5	
SVA111E	3/8	5	
SVA111F	1/2	5	
SVA111J	3/4	5	

## BRASS PIPE THREAD 45° MALE ELBOW

Line: 452-00

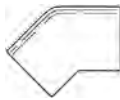

PART NO.	SIZE	QTY/BX	LIST PRICE
SWA129A	1/8	5	
SWA129C	1/4	5	
SWA129E	3/8	5	
SWA129F	1/2	5	
SWA129J	3/4	5	

## W/H BRASS LONG NIPPLE

Line: 452-01



PART NO.	SIZE	QTY/BX	LIST PRICE
SXA3327X2	1/8 X 1 1/2 (2155PNL2-15)	5	
SXA3328X2	1/8 X 2 (2155PNL-2-20)	5	
SXA3329X2	1/8 X 2 1/2 (2155PNL2-25)	5	
SXA3330X2	1/8 X 3 (2155PNL-2-30)	5	
SXA3327X4	1/4 X 1 1/2 (2155PNL4-15)	5	
SXA3328X4	1/4 X 2 (2155PNL-4-20)	5	
SXA3329X4	1/4 X 2 1/2 (2155PNL4-25)	5	
SXA3330X4	1/4 X 3 (2155PNL-4-30)	5	
SXA3331X4	1/4 X 3 1/2 (2155PNL4-35)	5	
SXA117E1-5	3/8 X 1 1/2 (2155PNL6-15)	5	
SXA3328X6	3/8 X 2 (2155PNL-6-20)	5	
SXA3329X6	3/8 X 2 1/2 (2155PNL6-25)	5	
SXA3330X6	3/8 X 3 (2155PNL-6-30)	5	
SXA117F1-5	1/2 X 1 1/2 (2155PNL8-15)	5	
SXA3328X8	1/2 X 2 (2155PNL-8-20)	5	
SXA3329X8	1/2 X 2 1/2 (2155PNL8-25)	5	
SXA3330X8	1/2 X 3 (2155PNL-8-30)	5	
SXA3331X8	1/2 X 3 1/2 (2155PNL8-35)	5	
SXA3328X12	3/4 X 2	5	
SXA3329X12	3/4 X 2 1/2	5	

## PIPE THREAD EXTRA LONG PIPE NIPPLE

Line: 453-00



PART NO.	SIZE	QTY/BX	LIST PRICE
SXA117A3-5	1/8 X 3 1/2 (215PNL2-35)	5	
SXA117A4	1/8 X 4	5	
SXA117A5	1/8 X 5	5	
SXA117A6	1/8 X 6	5	
SXA117C4	1/4 X 4	5	
SXA117C5	1/4 X 5	5	
SXA117C6	1/4 X 6	5	
SXA117E3-5	3/8 X 3 1/2 (215PNL635)	5	
SXA117E4	3/8 X 4	5	
SXA117E5	3/8 X 5	5	
SXA117E6	3/8 X 6	5	
SXA117F4	1/2 X 4	5	
SXA117F5	1/2 X 5	5	
SXA117F6	1/2 X 6	5	
SXA117J3	3/4 X 3	5	
SXA117J3-5	3/4 X 3 1/2	5	
SXA117J4	3/4 X 4	5	
SXA117J5	3/4 X 5	5	
SXA117J6	3/4 X 6	5	
SXA117N1-5	1 X 1 1/2	5	
SXA117N2	1 X 2	5	
SXA117N2-5	1 X 2 1/2	5	
SXA117N3	1 X 3	5	
SXA117N3-5	1 X 3 1/2	5	
SXA117N4	1 X 4	5	
SXA117N4-5	1 X 4 1/2	5	
SXA117N5	1 X 5	5	
SXA117N6	1 X 6	5	

## TANK AND VENT VALVE CAPS

Line: 454-00



PART NO.	SIZE	QTY/BX	LIST PRICE
TKA4V	HEX VALVE CAP	10	
TKA5VX	SLT VALV CAP	5	
TKA6V	DOME VLV CAP	25	

## LONG TANK AND VENT VALVES

Line: 455-00



PART NO.	SIZE	QTY/BX	LIST PRICE
TKAIVAH	1/8 HVY DUTY	5	
TKAIVAL	1/8	5	

## VENT VALVE SHORT

Line: 456-00



PART NO.	SIZE	QTY/BX	LIST PRICE
TKAVCORE	STANDARD VALVE CORE	100	
TKA3VAH	1/8 HVY DUTY	5	
TKA3VAL	1/8	5	
TKA3VCHX	1/4 HVY DUTY	5	
TKA3VCL	1/4	5	

## INV FLARE X SAE FLARE ADAPTER

Line: 463-00

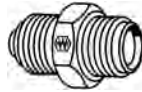

PART NO.	SIZE	QTY/BX	LIST PRICE
TLA1563	3/8 X 3/8	5	
TLA1554	7/16 X 3/8	5	

## MULTI-PURPOSE PIPE THREAD AIR VENT

Line: 464-00



PART NO.	SIZE	QTY/BX	LIST PRICE
TLA705-2	1/8	5	

## SPECIAL FORD CARB NUT & FITTING

Line: 468-00

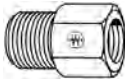

PART NO.	SIZE	QTY/BX	LIST PRICE
TLA1513	ADAPT FITT	5	
TLA59X4	1/4 CARB NUT 431F4	5	

## WATER LINE PIPE THD TO HOSE CONN

Line: 469-00

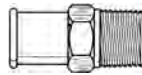

PART NO.	SIZE	QTY/BX	LIST PRICE
TLA1411	5/8 X 3/8 (68HB-10-6)	5	
TLA1431	5/8H X 1/2P (68HB-10-8)	5	
TLA1430	3/4H X 1/2P (68HB-12-8)	5	

## WATER LINE PIPE THD TO HOSE ELBOW

Line: 470-00

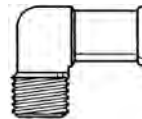

PART NO.	SIZE	QTY/BX	LIST PRICE
TLA1599	5/8 X 3/8	5	

## WIPER HOSE TEE

BRASS FITTING

Line: 471-00

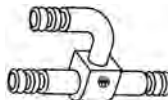

PART NO.	SIZE	QTY/BX	LIST PRICE
TLA1410	1/4	5	

## DOUBLE COMPRESSION NUT

Line: 472-00



PART NO.	SIZE	QTY/BX	LIST PRICE
TMA6100X2	1/8	10	
TMA6100X3	3/16	10	
TMA6100X4	1/4	10	
TMA6100X5	5/16	10	
TMA6100X6	3/8	10	
TMA11G	7/16	10	

## DOUBLE COMPRESSION UNION

Line: 473-00

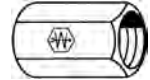

PART NO.	SIZE	QTY/BX	LIST PRICE
TNA13A	1/8	5	
TNA13B	3/16	5	
TNA6300X4	1/4	5	
TNA6300X5	5/16	5	
TNA13E	3/8	5	
TNA13F	1/2	5	

## DOUBLE COMPRESSION MALE CONN

Line: 474-00



PART NO.	SIZE	QTY/BX	LIST PRICE
TPA6200X2	1/8 X 1/8	5	
TPA6200X3	3/16 X 1/8	5	
TPA6200X4	1/4 X 1/8	5	
TPA6200X5	5/16 X 1/8	25	
TPA6200X5X4	5/16 X 1/4	25	
TPA12E	3/8 X 1/8	5	
TPA6200X6	3/8 X 1/4	5	

## DOUBLE COMPRESSION MALE ELBOW

Line: 475-00



PART NO.	SIZE	QTY/BX	LIST PRICE
TRA6400X2	1/8 X 1/8	5	
TRA6400X3	3/16 X 1/8	5	
TRA6400X4	1/4 X 1/8	5	
TRA6400X5	5/16 X 1/8	5	
TRA6400X6	3/8 X 1/4	5	

## ANGLE BIB DRAIN COCK

Line: 477-00

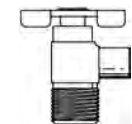

PART NO.	SIZE	QTY/BX	LIST PRICE
TUA6660-6-4	3/8 X 1/4	5	

## ANGLE BIB STYLE DRAIN COCK

Line: 478-00

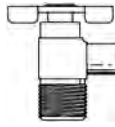

PART NO.	SIZE	QTY/BX	LIST PRICE
TUA150-2	1/8	5	
TUA120-4	1/4	5	

## DRAIN COCK LONG STEM

Line: 479-00

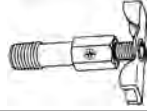

PART NO.	SIZE	QTY/BX	LIST PRICE
TUA185-2	1/8	5	

## BRASS EXTERNAL SEAT DRAIN COCK

Line: 480-00



PART NO.	SIZE	QTY/BX	LIST PRICE
TUA135-2	1/8 (DC604-2)	5	
TUA145-4	1/4 (DC604-4)	5	
TUA6788-4	1/4 NOZL (DC606-4)	5	
TUA270-6	3/8 (DC604-6)	5	
TUA108-8	1/2	5	

## BRASS INTERNAL SEAT DRAIN COCK

Line: 481-00

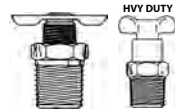

PART NO.	SIZE	QTY/BX	LIST PRICE
TUA130-2	1/8 (DC602-2)	5	
TUA1424-2	1/8 HVY DUTY (DC603-2)	5	
TUA6783-2	1/8 HOSE DRAIN STY	5	
TUA140-4	1/4	5	
TUA1425-4	1/4 HVY DUTY (DC603-4)	5	
TUA190-4X	1/4 (DC602-4)	5	
TUAIKE	3/8 IPT FORGED	5	
TUA1426-6	3/8 HVY DUTY (DC603-6)	5	
TUA230-6	3/8	5	
TUAIKF	1/2 IPT FORGED	5	

## BRASS GROUND PLUG DRAIN COCK

AIR STYLE

Line: 482-00

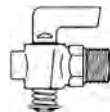

PART NO.	SIZE	QTY/BX	LIST PRICE
TUA6891-2	1/8 LEVER (DC601-2)	5	
TUA16LC-4	1/4 (C) LEVER TYPE	5	
TUA6892-4	1/4 LEVER (DC601-4)	5	
TUA6893-6	3/8 LEVER (DC601-6)	5	
TUA7LF0-8	1/2(C) LEVER (DC601-8)	5	

## MARINE TYPE SHUT OFF

MALE - FEMALE PIPE THREAD

Line: 483-00



PART NO.	SIZE	QTY/BX	LIST PRICE
TVA6828-4	1/4	5	

## BRASS SHUT OFF FORGD DBL FEM P.T.

Line: 484-00

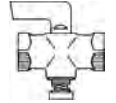

PART NO.	SIZE	QTY/BX	LIST PRICE
TVA6804-2	1/8 (V403P-2-2)	5	
TVA6809-4	1/4 (V403P-4-4)	5	
TVA131E-6	3/8(C) (V403P-6-6(P))	5	
TVA131F-8	1/2 (C)	5	

## BRASS SHUT OFF DBL MALE

P.T. FORGED

Line: 485-00



PART NO.	SIZE	QTY/BX	LIST PRICE
TVA176A-2	1/8(P) (V401P-2-2)	5	
TVA176C-4	1/4(P) (V401P-4-4)	5	
TVA176E-6	3/8(C)	5	

## BRASS SHUT OFF DBL MALE X FEMALE

P.T. FORGED

Line: 486-00

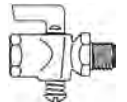

PART NO.	SIZE	QTY/BX	LIST PRICE
TVA6824-2	1/8 (V402P-2-2)	5	
TVA6829-4	1/4 (V402P-4-4)	5	
TVA148E-6	3/8(P) (V402P-6-6)	5	

## SHUT OFF DOUBLE FEMALE

P.T. EXTRUD

Line: 487-00

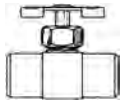

PART NO.	SIZE	QTY/BX	LIST PRICE
TVA6800-2	1/8 (NV109P-2)	5	
TVA6805-4	1/4 (NV109P-4)	5	

## BRASS SHUT OFF DBL MALE P.T.

Line: 488-00

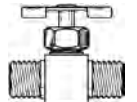

PART NO.	SIZE	QTY/BX	LIST PRICE
TVA6810-2	1/8 (NV107P-2)	5	
TVA6815-4	1/4 (NV107P-4)	5	

**SHUT OFF MALE X FEMALE**

P.T. EXTRUD  
Line: 489-00

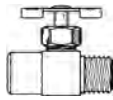

PART NO.	SIZE	QTY/BX	LIST PRICE
TVA6820-2	1/8 (NV108P-2)	5	
TVA6825-4	1/4 (NV108P-4)	5	

**BRASS TRUCK WATER SHUT OFF WHEEL HANDLE**

Line: 490-00

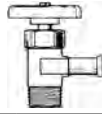

PART NO.	SIZE	QTY/BX	LIST PRICE
TVA1422-6-6	3/8 X 3/8 (V404P66)	5	
TVAV409F108	5/8SAE FLX 1/2 MPT 90°	5	
TVA1423-10-6	5/8 X 3/8 (V404P10-6)	2	
TVA1433-12-6	3/4 X 3/8 MP X HSE	5	
TVA1451-12-8	3/4 X 1/2 (SV404P128)	5	

**SHUT OFF COMP STRA X MPT GRND PLUG**

Line: 491-00

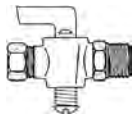

PART NO.	SIZE	QTY/BX	LIST PRICE
TWAA6754-4-4	1/4 X 1/4 (V304C-4-4)	5	
TWAA694-4-2	1/4 X 1/8 (V304C-42)	5	
TWAA664-5-2	5/16 X 1/8	5	
TWAA6759-5-4	5/16 X 1/4	5	
TWAA6764-6-4	3/8 X 1/4 (V304C-6-4)	5	
TWA275FF-8-8	1/2 X 1/2 (C)	5	

**SHUT OFF SAE FLR STRA X MPT GR PLUG**

Line: 492-00

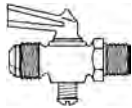

PART NO.	SIZE	QTY/BX	LIST PRICE
TWAA537-4-2	1/4 X 1/8 (V204F42)	5	
TWA27SEEE-6-6	3/8 X 3/8 (C)	5	
TWA703-6-4	3/8 X 1/4 (V204F64)	5	

**SHUT OFF COMPRESSION ANGLE**

Line: 493-00

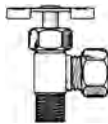

PART NO.	SIZE	QTY/BX	LIST PRICE
TWAA6845-3-2	3/16 X 1/8	5	
TWAA555-4-2	1/4 X 1/8 (NV104C42)	5	
TWANV312P42	1/4 POLYTITE X 1/8MP	5	
TWANV312P44	1/4 POLYTITE X 1/4 MP	5	
TWAA655-5-2	5/16 X 1/8 (NV104C52)	5	
TWAA6855-5-4	5/16 X 1/4	5	
TWAA6860-6-4	3/8 X 1/4 (NV104C64)	5	

**SHUT OFF COMP TO COMP**

FORGED BRASS  
Line: 494-00

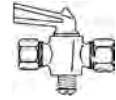

PART NO.	SIZE	QTY/BX	LIST PRICE
TWAA6769-4	1/4 (V303C-4-4(P))	5	
TWAA6774-5	5/16	5	
TWAA6779-6	3/8 (V303C-6-6)	5	

**SHUT OFF COMP TO COMP**

NEEDLE VALVE  
Line: 495-00

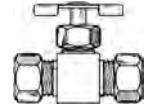

PART NO.	SIZE	QTY/BX	LIST PRICE
TWAA6763-3	3/16 COMP X COMP	5	
TWAA6765-4	1/4 (NV105C-4)	5	
TWAA6770-5	5/16 (NV105C-5)	5	
TWAA6775-6	3/8 (NV105C-6)	5	

**STRAIGHT COMP X MALE PIPE THREAD**

NEEDLE VALVE SHUT OFF  
Line: 496-00

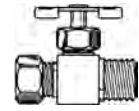

PART NO.	SIZE	QTY/BX	LIST PRICE
TWASA6690	3/16 X 1/8	5	
TWASA690-4-2	1/4 X 1/8 (NV106C-4-2)	5	
TWAA104KCCX	1/4 X 1/4(C) (NV106C4-4)	5	
TWASA660-5-2	5/16 X 1/8 (NV106C5-2)	5	
TWASA6755-5-4	5/16 X 1/4	5	
TWASA6760-6-4	3/8 X 1/4 (NV106C64)	5	

**SHUT OFF INVERTED FLARE ANGLE**

BRASS FITTING  
Line: 497-00



PART NO.	SIZE	QTY/BX	LIST PRICE
TWAA730-4-2	1/4 X 1/8 (B730)	5	
TWAA775-5-2	5/16 X 1/8 (B775)	5	
TWAA6890-6-4	3/8X1/4 (NV104C-6-4)	5	

**SHUT OFF SAE FLARE ANGLE**

BRASS FITTING  
Line: 498-00



PART NO.	SIZE	QTY/BX	LIST PRICE
TWA320-4-2	1/4 X 1/8 (NV101F-4-2)	5	
TWA325-5-2	5/16 X 1/8	5	
TWA6703-5-4	5/16 X 1/4	5	
TWA330-6-4	3/8 X 1/4	5	

## SHUT OFF DOUBLE SAE FLARE

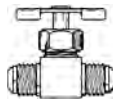

Line: 499-00

PART NO.	SIZE	QTY/BX	LIST PRICE
TWA6715-4	1/4 (NV102F-4)	5	
TWA106SE-6	3/8(P) (NV102F-6)	5	

## SHUT OFF DOUBLE SAE FLARE GRND PLUG



Line: 500-00

PART NO.	SIZE	QTY/BX	LIST PRICE
TWA6719-4	1/4	5	
TWA6724-5	5/16	5	
TWA6729-6	3/8 (V203F-6-6)	5	
TWA28SF-8	1/2	5	

## SHUT OFF SAE FLARE TO PIPE THD STRAIGHT

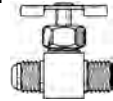

Line: 501-00

PART NO.	SIZE	QTY/BX	LIST PRICE
TWA530-4-2	1/4 X 1/8 (NV103F42)	5	
TWA6700-4-4	1/4 X 1/4	5	
TWA630-5-2	5/16 X 1/8	5	
TWA695-5-4	5/16 X 1/4	5	
TWA700-6-4	3/8 X 1/4 (NV103F64)	5	

## SHUT OFF PIPE TO HOSE W/SCREEN FILTER



Line: 502-00

PART NO.	SIZE	QTY/BX	LIST PRICE
TWA6600-4-2	1/4 X 1/8	5	

## WATER SHUT OFF HOSE TO PIPE STEEL BODY

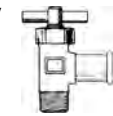

Line: 503-00

PART NO.	SIZE	QTY/BX	LIST PRICE
TXA211280106	5/8 X 3/8 90°	5	

## 3-WAY LEVER VALVE FEMALE PIPE THREAD



Line: 509-00

PART NO.	SIZE	QTY/BX	LIST PRICE
TZA6749	1/4 FEMALE PT (V406P4)	5	
TZA6709	3/8 FEMALE	5	

## 4-WAY LEVER VALVE 1/4 FEM PIPE THREAD

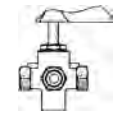

Line: 510-00

PART NO.	SIZE	QTY/BX	LIST PRICE
TZA6748	4/WAY VLV 1/4 FEMALE	5	
TZA6747	1/4FE SHT (V407P4)	5	

## PARKER BRASS BALL VALVE

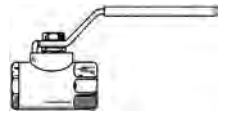

Line: 511-02

PART NO.	SIZE	QTY/BX	LIST PRICE
AGBV500P4	1/4 PIPE (V500P4)	1	
AGBV500PUL6	3/8 NPT FLAM GAS UL	1	
AGBV500P6	3/8 PIPE (V500P6)	1	
AGBV500P8VLO	1/2 (XVVP500P-8)	1	
AGBV500P8	1/2 PIPE (V500P8)	1	
AGBV500P12SSH	3/4 (XV500P-12-02)	1	
AGBV500P12VLO	3/4 (XVVP500P-12)	1	
AGBV500P12	3/4 PIPE (V500P12)	1	
AGBV500P16	1 PIPE (V500P16)	1	
AGBV500P16SSH	1 (XV500P-16-02)	1	
AGBV500P16VLO	1 (XVVP500P-16)	1	
AGBV500P20	1 1/4	1	
AGBV500P20SSH	1 1/4 (V500P-20-02)	1	
AGBV500P24	1 1/2	1	
AGBV500P24SSH	1 1/2 (V500P-24-02)	1	
AGB2032SSHNDL	S/S HANDLES 1 1/4-2	1	
AGBV500P32SSH	2 (V500P-32-02)	1	
AGBV500P32	2 PIPE (V520P-32)	1	
AGB0408HNDL	HANDLES FOR 1/4-1/2	1	
AGB1216HNDL	HANDLES FOR 3/4 & 1	1	

## STAINLESS STEEL SHARPE BALL VALVE

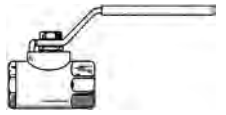

Line: 511-03

PART NO.	SIZE	QTY/BX	LIST PRICE
ASFV500SSX4	1/4 PIPE THREAD	1	
ASFV500SSX6	3/8 PIPE THREAD	1	
ASFV500SSX8	1/2 PIPE THREAD	1	
ASFV500SSX12	3/4 PIPE THREAD	1	
ASFV500SSX20	1 1/4 PIPE THREAD	1	
ASFV500SSX24	1 1/2 PIPE THREAD	1	
ASFV500SSX16	1 PIPE THREAD	1	
ASFV500SSX32	2	1	
ASFV500SSX48	3	1	

## BRASS REGULAR BALL VALVE

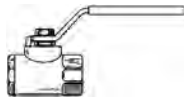

Line: 511-06

PART NO.	SIZE	QTY/BX	LIST PRICE
AGB107900	1/8 BV2103-A FRGD	1	
AGB888030	1/4-3/4REPL HANDLE	10	
AGB107901	1/4	1	
AGB107902	3/8	1	
AGB107903	1/2	1	
AGB107754	3/4 W/DRAIN CAP S&W	1	
AGB107904	3/4	1	
AGB107755	1 W/DRAIN CAP S&W	1	
AGB107905	1	1	
AGB888031	1-1 1/4 REPL HANDLE	10	
AGB107906	1 1/4	1	
AGB107907	1 1/2 PIPE SPP	1	
AGB107908	2	1	
AGB107709	2 1/2	1	
AGB107710	3	1	
AGB107711	4	1	

## LIQUID/DRY PRESSURE/VACUUM GAUGE (cont.)



Line: 511-07

PART NO.	SIZE	QTY/BX	LIST PRICE
BDH153252	0-300/PSI	1	
BDH153252DRY	0-300 PSI DRY	1	
BDH153254	0-600/PSI	1	
BDH153254DRY	0-600 PSI DRY	1	
BDH153256	0-1000/PSI	1	
BDH153256DRY	0-1000 PSI DRY	1	
BDH153257	0-1500/PSI	1	
BDH153257DRY	0-1500 PSI DRY	1	
BDH153258	0-2000/PSI	1	
BDH153258DRY	0-2000 PSI DRY	1	
BDH153259	0-3000/PSI	1	
BDH153259DRY	0-3000 PSI DRY	1	
BDH153261	0-5000/PSI	1	
BDH153261DRY	0-5000 PSI DRY	1	

## CARBON STEEL HI-PRES BALL VALVE 2M PSI

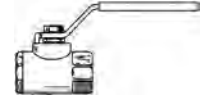

Line: 511-10

PART NO.	SIZE	QTY/BX	LIST PRICE
AUTXV500HP4	1/4 FPT 6M PSI P/H	1	
AUT04	1/4 FPT CARBON V500	1	
AUT06	3/8 FPT CARBON V500	1	
AUT08	1/2 FPT CARBON V500	1	
AUT12	3/4 FPT CARBON V500	1	
AUT16	1 FPT CARBON V500	1	
AUT20	1 1/4 FPT 3911 GRINNELL	1	
AUT24	1 1/2 FPT 3911 GRINNELL	1	
AUT32	2FPT 3911 GRINNELL	1	

## LIQUID/DRY PRESSURE/VACUUM GAUGE



Line: 511-07

PART NO.	SIZE	QTY/BX	LIST PRICE
BDH010000	0-10000 PSI	1	
BDH04000DRY	0-4000 PSI DRY	1	
BDH06000	0-6000 PSI	1	
BDH06000DRY	0-6000 PSI DRY	1	
BDH153240	30VAC 0/PSI	1	
BDH153241	30 VAC 15/PSI	1	
BDH153242	30 VAC 30/PSI	1	
BDH153242DRY	30VAC 30/PSI DRY	1	
BDH153243	30VAC 60/PSI	1	
BDH153244	30VAC 100/PSI	1	
BDH153246	0-15/PSI	1	
BDH153246DRY	0-15 PSI DRY	1	
BDH153247	0-30/PSI	1	
BDH153247DRY	0-30 PSI DRY	1	
BDH153248	0-60/PSI	1	
BDH153248DRY	0-60 PSI DRY	1	
BDH153249	0-100/PSI	1	
BDH153249DRY	0-100 PSI/DRY	1	
BDH153250	0-160/PSI	1	
BDH153250DRY	0-160 PSI DRY	1	
BDH153251	0-200/PSI	1	
BDH153251DRY	0-200 PSI DRY	1	

## P/H PRESTOLOK UNION #62PL



Line: 512-20

PART NO.	SIZE	QTY/BX	LIST PRICE
AMY62PLX2	1/8 (62PL-2)	5	
AMY62PLX3	3/16 (62PLX3)	5	
AMY62PLX4	1/4 (62PL-4)	5	
AMY62PLX5	5/16 (62PL-5)	5	
AMY62PLX532	5/32 (62PLX532)	5	
AMY62PLX6	3/8 (62PL-6)	5	
AMY62PLX8	1/2 (62PL-8)	5	

(continued...)

## P/H PRESTOLOK BULK HEAD UNION #62PBL

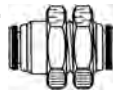

Line: 512-21

PART NO.	SIZE	QTY/BX	LIST PRICE
AMZ62PLBHX2	1/8	5	
AMZ62PLBHX532	5/32	5	
AMZ2700LNX3	3/16 (BPC2700-LN-3-3)	5	
AMZ62PLBHX4	1/4	5	
AMZ62PLBHX5	5/16	5	
AMZ62PLBHX6	3/8	5	
AMZ62PLBHX8	1/2	2	

## P/H PRESTOLOK FEMALE CONN #66PL



Line: 512-22

PART NO.	SIZE	QTY/BX	LIST PRICE
AND66PL2X2	1/8 X 1/8 (66PL-2-2)	5	
AND66PL532X2	5/32 X 1/8	5	
AND66PL532X4	5/32 X 1/4	5	
AND66PL4X2	1/4 X 1/8 (66PL-4-2)	5	
AND66PL4X4	1/4 X 1/4	5	
AND66PL5X2	5/16 X 1/8 (66PL-5-2)	5	
AND66PL5X4	5/16 X 1/4 (66PL-5-4)	5	
AND66PL6X4	3/8 X 1/4 (66PL-6-4)	5	
AND66PL6X6	3/8 X 3/8	5	

## P/H PRESTOLOK UNION TEE #164PL



Line: 512-23

PART NO.	SIZE	QTY/BX	LIST PRICE
ANE164PLX2	1/8 (164PL-2)	5	
ANE164PLX532	5/32	5	
ANE164PLX4	1/4 (164PL-4)	5	
ANE164PLX5	5/16	5	
ANE164PLX6	3/8	5	
ANE164PLX8	1/2	2	

## P/H PRESTOLOK UNION-Y-CONN #662PL

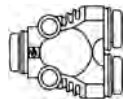

Line: 512-24

PART NO.	SIZE	QTY/BX	LIST PRICE
ANF662PLX532	5/32	5	
ANF362PLX4	1/4	5	

## P/H PRESTOLOK UNION ELBOW #169PL



Line: 512-25

PART NO.	SIZE	QTY/BX	LIST PRICE
ANG165PLX2	1/8 (165PL-2)	5	
ANG165PLX4	1/4 (165PL-4)	5	
ANG165PLX5	5/16 (165PL-5)	5	
ANG165PLX6	3/8 (165PL-6)	5	
ANG165PLX532	5/32	5	
ANG165PLX8	1/2	2	

## P/H PRESTOLOK MALE ELBOW #169PLNS



Line: 512-26

PART NO.	SIZE	QTY/BX	LIST PRICE
ANH169NS2X2	1/8 X 1/8 (169PLNS2-2)	5	
ANH169NS532X2	5/32 X 1/8 (169PLNS5322)	5	
ANH169NS532X4	5/32 X 1/4 (169PLNS5324)	5	
ANH169NS3X2	3/16 X 1/8 STD	5	
ANH169NS4X2	1/4 X 1/8 (169PLNS4-2)	5	
ANH169NS4X4	1/4 X 1/4 (169PLNS4-4)	5	
ANH169NS5X2	5/16 X 1/8 (169PLNS5-2)	5	
ANH169NS5X4	5/16 X 1/4	5	
ANH169NS6X4	3/8 X 1/4 (169PLNS6-4)	5	
ANH169NS6X6	3/8 X 3/8	5	
ANH169NS6X8	3/8 X 1/2	5	
ANH169NS8X6	1/2 X 3/8 (169PLNS8-6)	2	
ANH169NS8X8	1/2 X 1/2	2	

## P/H PRESTOLOK SWIVEL 90° ELBOW

#169PL

Line: 512-27



PART NO.	SIZE	QTY/BX	LIST PRICE
ANJ169PL2X2	1/8 X 1/8	5	
ANJ169PL21032	1/8 X 10/32	5	
ANJFC701532X2	5/32 X 1/8	1	
ANJ369ML532X2	5/32 X 1/8	5	
ANJFC701532X0	5/32 X 10/32	1	
ANJ169PL51032	5/32 X 10/32	5	
ANJ169PL532X2	5/32 X 2	5	
ANJ169PL532X4	5/32 X 4	5	
ANJ169PL3X2	3/16 X 1/8	5	
ANJFC7014X2	1/4 X 1/8	1	
ANJ169PL4X2	1/4 X 1/8	5	
ANJ369ML4X2	1/4 X 1/8 (MICROLOK)	10	
ANJ169PL4X4	1/4 X 1/4	5	
ANJ169PL4X6	1/4 X 3/8	5	
ANJ169PL41032	1/4 X 10/32	5	
ANJ369ML4X0	1/4 X 10/32 (MICROLOK)	10	



**P/H PRESTOLOK SWIVEL 90° ELBOW (cont.)**

#168PL  
Line: 512-27



PART NO.	SIZE	QTY/BX	LIST PRICE
ANJ169PL5X2	5/16 X 1/8	5	
ANJ169PL5X4	5/16 X 1/4	5	
ANJ169PL6X2	3/8 X 1/8	5	
ANJ169PL6X4	3/8 X 1/4	5	
ANJ169PL6X6	3/8 X 3/8	5	
ANJ169PL6X8	3/8 X 1/2	5	
ANJ169PL8X4	1/2 X 1/4	5	
ANJ169PL8X6	1/2 X 3/8	5	
ANJ169PL8X8	1/2 X 1/2	5	

**P/H PRESTOLOK MALE CONN #68PL**

Line: 512-28



PART NO.	SIZE	QTY/BX	LIST PRICE
ANK68PL2X1	1/8 X 1/16	5	
ANK68PL2X4	1/8 X 1/4	5	
ANK68PL2X2	1/8 X 1/8	5	
ANK68PL2X1032	1/8 X 10/32	5	
ANK68PL532X2	5/32 X 1/8	5	
ANK68PL532X4	5/32 X 1/4	5	
ANK68PL5X1032	5/32 X 10/32	5	
ANK68PL3X2	3/16 X 1/8	5	
ANK68PL3X4	3/16 X 1/4	5	
ANK68PL4X1	1/4 X 1/16	5	
ANK68PL4X2	1/4 X 1/8	5	
ANK68PL4X4	1/4 X 1/4	5	
ANK68PL4X1032	1/4 X 10/32	5	
ANK68PL4X6	1/4 X 3/8	5	
ANK68PL5X2	5/16 X 1/8	5	
ANK68PL5X4	5/16 X 1/4	5	
ANK68PL5X6	5/16 X 3/8	5	
ANK68PL6X2	3/8 X 1/8	5	
ANK68PL6X4	3/8 X 1/4	5	
ANK68PL6X6	3/8 X 3/8	5	
ANK68PL6X8	3/8 X 1/2	2	
ANK68PL8X4	1/2 X 1/4	5	
ANK68PL8X6	1/2 X 3/8	2	
ANK68PL8X8	1/2 X 1/2	2	

**PRESTOLOK MALE BRANCH SWIVEL TEE**

Line: 512-29



PART NO.	SIZE	QTY/BX	LIST PRICE
CCE172PL42	1/4 X 1/8	5	
CCE172PL44	1/4 X 1/4	5	
CCE172PL64	3/8 X 1/4	5	

**PRESTO/MATIC AIR BRAKE**

FEMALE ELBOW - 270 PMTNS  
Line: 512-50

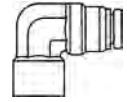

PART NO.	SIZE	QTY/BX	LIST PRICE
BMW170PMTNS42	1/4 T X 1/8 FP	4	
BMW270PMTNS44	1/4 T X 1/4 FP	4	
BMW270PMTNS64	3/8 T X 1/4 FP	4	
BMW270PMTNS66	3/8 T X 3/8 FP	4	
BMW270PMTNS84	1/2 T X 1/4 FP	4	
BMW270PMTNS86	1/2 T X 3/8 FP	4	
BMW270PMTNS88	1/2 T X 1/2 FP	4	

**PRESTO/MATIC AIR BRAKE UNION**

Line: 512-51



PART NO.	SIZE	QTY/BX	LIST PRICE
BMX62PM2	1/8	5	
BMX62PMT4	1/4	4	
BMX62PMT6	3/8	4	
BMX62PMT8	1/2	4	
BMX62PMT10	5/8	2	

**PRESTO/MATIC AB BULK HEAD UNION**

Line: 512-52

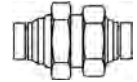

PART NO.	SIZE	QTY/BX	LIST PRICE
BMY62PMTBH4	1/4	4	
BMY62PMTBH6	3/8	4	
BMY62PMTBH8	1/2	2	
BMY62PMTBH10	5/8	5	

**PRESTO/MATIC AB FEM CONNECTOR**

Line: 512-53

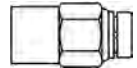

PART NO.	SIZE	QTY/BX	LIST PRICE
BMZ66PMT42	1/4 T X 1/8 FP	4	
BMZ66PMT44	1/4 T X 1/4 FP	4	
BMZ66PMT62	3/8 T X 1/8 FP	4	
BMZ66PMT64	3/8 T X 1/4 FP	4	
BMZ66PMT66	3/8 T X 3/8 FP	4	
BMZ66PMT84	1/2 T X 1/4 FP	4	
BMZ66PMT86	1/2 T X 3/8 FP	4	
BMZ66PMT88	1/2 T X 1/2 FP	4	

## PRESTO/MATIC AB MALE CONNECTOR

Line: 512-54

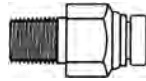

PART NO.	SIZE	QTY/BX	LIST PRICE
BND68PM21	1/8 T X 1/16 MP	5	
BND68PM22	1/8 T X 1/8 MP	4	
BND68PM5321	5/32 T X 1/16 MP	5	
BND68PM5322	5/32 T X 1/8 MP	4	
BND68PM32	3/16 T X 1/8 MP	4	
BND68PMT42	1/4 T X 1/8 MP	4	
BND68PMT44	1/4 T X 1/4 MP	4	
BND68PMT46	1/4 T X 3/8 MP	4	
BND68PMT62	3/8 T X 1/8 MP	4	
BND68PMT64	3/8 T X 1/4 MP	4	
BND68PMT66	3/8 T X 3/8 MP	4	
BND68PMT68	3/8 T X 1/2 MP	4	
BND68PMT84	1/2 T X 1/4 MP	4	
BND68PMT86	1/2 T X 3/8 MP	4	
BND68PMT88	1/2 T X 1/2 MP	4	
BND68PMT106	5/8 T X 3/8 MP	4	
BND68PMT108	5/8 T X 1/2 MP	4	

## PRESTO/MATIC AB UNION TEE

Line: 512-55

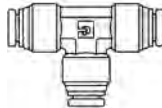

PART NO.	SIZE	QTY/BX	LIST PRICE
BNE264PMT4	1/4	4	
BNE264PMT6	3/8	4	
BNE264PMT8	1/2	2	

## PRESTO/MATIC AB UNION ELBOW

Line: 512-56

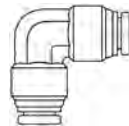

PART NO.	SIZE	QTY/BX	LIST PRICE
BNF265PMT4	1/4	4	
BNF265PMT6	3/8	4	
BNF265PMT8	1/2	2	

## PRESTO/MATIC AB MALE/SWIVEL ELBOW

Line: 512-57

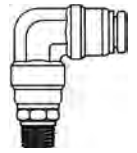

PART NO.	SIZE	QTY/BX	LIST PRICE
BNG369PM22	1/8 X 1/8 COMPOSITE BODY	4	
BNG369PM5322	1/8 X 5/32 COMPOSITE BODY	4	
BNG269PMT42	1/4 T X 1/8 MP	4	
BNG269PMT44	1/4 T X 1/4 MP	4	
BNG269PMT46	1/4 T X 3/8 MP	4	
BNG269PMT62	3/8 T X 1/8 MP	4	
BNG269PMT64	3/8 T X 1/4 MP	4	
BNG269PMT66	3/8 T X 3/8 MP	4	
BNG269PMT68	3/8 T X 1/2 MP	4	
BNG269PMT84	1/2 T X 1/4 MP	4	
BNG269PMT86	1/2 T X 3/8 MP	4	
BNG269PMT88	1/2 T X 1/2 MP	4	

## PRESTO/MATIC AIR BRAKE SWIVEL MB TEE

Line: 512-58

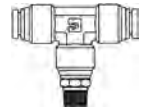

PART NO.	SIZE	QTY/BX	LIST PRICE
BNH272PMT42	1/4 T X 1/8 MP	4	
BNH272PMT44	1/4 T X 1/4 MP	4	
BNH272PMT62	3/8 T X 1/8 MP	4	
BNH272PMT64	3/8 T X 1/4 MP	4	
BNH272PMT66	3/8 T X 3/8 MP	4	
BNH272PMT84	1/2 T X 1/4 MP	2	
BNH272PMT86	1/2 T X 3/8 MP	2	
BNH272PMT88	1/2 T X 1/2 MP	2	

## PRESTO/MATIC AB MALE/ELBOW

Line: 512-59



PART NO.	SIZE	QTY/BX	LIST PRICE
BNJ69PM22	1/8 T X 1/8 MP	4	
BNJ169PMN5322	5/32 T X 1/8 MP	4	
BNJ169PMNS32	3/16 T X 1/8 MP	4	
BNJ269PMTNS42	1/4 T X 1/8 MP	4	
BNJ269PMTNS44	1/4 T X 1/4 MP	4	
BNJ269PMTNS46	1/4 T X 3/8 MP	4	
BNJ269PMTNS62	3/8 T X 1/8 MP	4	
BNJ269PMTNS64	3/8 T X 1/4 MP	4	
BNJ269PMTNS66	3/8 T X 3/8 MP	4	
BNJ269PMTNS68	3/8 T X 1/2 MP	4	
BNJ269PMTNS84	1/2 T X 1/4 MP	4	
BNJ269PMTNS86	1/2 T X 3/8 MP	4	
BNJ269PMTNS88	1/2 T X 1/2 MP	4	
BNJ169PTNS106	5/8 T X 3/8 MP	4	
BNJ169PTNS108	5/8 T X 1/2 MP	4	

## PRESTO/MATIC AB 45° MALE/ELBOW

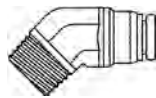

Line: 512-60

PART NO.	SIZE	QTY/BX	LIST PRICE
BNK279PMTNS42	1/4 T X 1/8 MP	5	
BNK279PMTNS44	1/4 T X 1/4 MP	4	
BNK279PMTNS62	3/8 T X 1/8 MP	5	
BNK279PMTNS64	3/8 T X 1/4 MP	4	
BNK279PMTNS66	3/8 T X 3/8 MP	4	
BNK279PMTNS84	1/2 T X 1/4 MP	5	
BNK279PMTNS86	1/2 T X 3/8 MP	2	
BNK279PMTNS88	1/2 T X 1/2 MP	2	
BNK179PTNS106	5/8 T X 3/8 MP	4	
BNK179PTNS108	5/8 T X 1/2 MP	4	

## TRUE SEAL GREY MALE CONNECTOR

PARKER HANNIFIN - COMPOSITE



Line: 512-70

PART NO.	SIZE	QTY/BX	LIST PRICE
BYTA4MC2	1/4 X 1/8 MP	10	
BYTA4MC4	1/4 X 1/4 MP	10	
BYTA4MC6	1/4 X 3/8 MP	10	
BYTA5MC2	5/16 X 1/8 MP	10	
BYTA5MC4	5/16 X 1/4 MP	10	
BYTA6MC2	3/8 X 1/8 MP	5	
BYTA6MC4	3/8 X 1/4 MP	10	
BYTA6MC6	3/8 X 3/8 MP	10	
BYTA6MC8	3/8 X 1/2 MP	5	
BYTA8MC6	1/2 X 3/8 MP	5	
BYTA8MC8	1/2 X 1/2 MP	5	

## TRUE SEAL GREY UNION ELBOW

PARKER HANNIFIN - COMPOSITE



Line: 512-71

PART NO.	SIZE	QTY/BX	LIST PRICE
BYVA4EU4	1/4	10	
BYVA5EU5	5/16	10	
BYVA6EU6	3/8	10	
BYVA8EU8	1/2	5	

## TRUE SEAL GREY UNION TEE

PARKER HANNIFIN - COMPOSITE



Line: 512-72

PART NO.	SIZE	QTY/BX	LIST PRICE
BYWA4TU4	1/4	5	
BYWA5TU5	5/16	5	
BYWA6TU6	3/8	5	
BYWA8TU8	1/2	5	

## TRUE SEAL GREY SWIVEL MALE ELBOW

PARKER HANNIFIN - COMPOSITE



Line: 512-73

PART NO.	SIZE	QTY/BX	LIST PRICE
BYXA4MES2	1/4 X 1/8	10	
BYXA4MES4	1/4 X 1/4	10	
BYXA4MES6	1/4 X 3/8	10	
BYXA5MES4	5/16 X 1/4	10	
BYXA5MES6	5/16 X 3/8	10	
BYXA6MES4	3/8 X 1/4	10	
BYXA6MES6	3/8 X 3/8	5	
BYXA8MES6	1/2 X 3/8	5	
BYXA8MES8	1/2 X 1/2	5	

## TRUE SEAL MALE RUN SWIVEL TEE

PARKER HANNIFIN - COMPOSITE



Line: 512-74

PART NO.	SIZE	QTY/BX	LIST PRICE
BYYA4MRS2	1/4 X 1/8	5	
BYYA4MRS4	1/4 X 1/4	5	
BYYA5MRS4	5/16 X 1/4	5	
BYYA6MRS4	3/8 X 1/4	5	
BYYA6MRS6	3/8 X 3/8	5	
BYYA8MRS6	1/2 X 3/8	5	
BYYA8MRS8	1/2 X 1/2	5	

## TRUE SEAL GREY MALE BR SWIVEL TEE

PARKER HANNIFIN - COMPOSITE



Line: 512-75

PART NO.	SIZE	QTY/BX	LIST PRICE
BYZA4MTS2	1/4 X 1/8	5	
BYZA4MTS4	1/4 X 1/4	5	
BYZA5MTS4	5/16 X 1/4	5	
BYZA6MTS4	3/8 X 1/4	5	
BYZA6MTS6	3/8 X 3/8	5	
BYZA8MTS6	1/2 X 3/8	5	
BYZA8MTS8	1/2 X 1/2	5	

## TRUE SEAL GREY UNION

PARKER HANNIFIN - COMPOSITE



Line: 512-76

PART NO.	SIZE	QTY/BX	LIST PRICE
BZDA4UC4	1/4	10	
BZDA5UC4	5/16-1/4 REDUCER	10	
BZDA5UC5	5/16	10	
BZDA6UC6	3/8	10	
BZDA8UC8	1/2	5	

## TRUE SEAL GREY FEMALE CONNECTOR

PARKER HANNIFIN - COMPOSITE

Line: 512-77



PART NO.	SIZE	QTY/BX	LIST PRICE
BZEA4FC2	1/4 X 1/8	10	
BZEA4FC4	1/4 X 1/4	10	
BZEA5FC4	5/16 X 1/4	10	
BZEA6FC4	3/8 X 1/4	10	
BZEA6FC6	3/8 X 3/8	5	
BZEA8FC6	1/2 X 3/8	5	
BZEA8FC8	1/2 X 1/2	5	

## TRUE SEAL TUBE STEM X MLE PIPE ADAPTER

PARKER HANNIFIN - COMPOSITE

Line: 512-78



PART NO.	SIZE	QTY/BX	LIST PRICE
BZFA4TMC2	1/4 X 1/8	10	
BZFA4TMC4	1/4 X 1/4	10	
BZFA5TMC4	5/16 X 1/4	10	
BZFA6TMC4	3/8 X 1/4	10	
BZFA6TMC6	3/8 X 3/8	10	
BZFA8TMC6	1/2 X 3/8	5	
BZFA8TMC8	1/2 X 1/2	5	

## TRUE SEAL GREY FEMALE ELBOW

PARKER HANNIFIN - COMPOSITE

Line: 512-79



PART NO.	SIZE	QTY/BX	LIST PRICE
BZGA4FE4	1/4 X 1/4	10	
BZGA6FE4	3/8 X 1/4	10	

## TRUE SEAL TUBE X BARB

STRAIGHT CONNECTOR - PARKER HANNIFIN - COMPOSITE

Line: 512-80



PART NO.	SIZE	QTY/BX	LIST PRICE
BZHA4TCB4	1/4 X 1/4	10	
BZHA6TCB4	3/8 X 1/4	10	
BZHA6TCB6	3/8 X 3/8	10	
BZHA8TCB6	1/2 X 3/8	10	
BZHA8TCB8	1/2 X 1/2	5	

## TRUE SEAL TUBE X BARB 90° ELBOW

PARKER HANNIFIN - COMPOSITE

Line: 512-81



PART NO.	SIZE	QTY/BX	LIST PRICE
BZJA4TEB4	1/4 X 1/4	10	
BZJA6TEB6	3/8 X 3/8	10	
BZJA8TEB8	1/2 X 1/2	5	

## TRUE SEAL TUBE PLUGS & TOOLS

PARKER HANNIFIN - COMPOSITE

Line: 512-82



PART NO.	SIZE	QTY/BX	LIST PRICE
BZKAQRT	QUICK RELEASE TOOL	1	
BZKPTC001RB	PLASTIC TUBE CUTTER	1	
BZKA4TPL	1/4	10	
BZKA6TPL	3/8	10	
BZKA8TPL	1/2	10	

## POLY FLOW FITTING BRASS SLEEVE

Line: 513-00



PART NO.	SIZE	QTY/BX	LIST PRICE
ZWA260U01X	1/16	10	
ZWA601X2	1/8	10	
ZWA601X3	3/16	10	
ZWA601X4	1/4	10	
ZWA601X5	5/16	10	
ZWA601X6	3/8	10	
ZWA601X8	1/2	10	
ZWA601X10	5/8	5	
ZWA601X12	3/4	5	
ZWA601X16	1	5	

## POLY FLOW ACETAL SLEEVE

Line: 513-01



PART NO.	SIZE	QTY/BX	LIST PRICE
ZVA1260X4	1/4	50	
ZVA1260X5	5/16	50	
ZVA1260X6	3/8	50	
ZVA1260X8	1/2	25	

## POLY FLOW FITTING SLEEVE NUT ASSEMBLY

Line: 514-00



PART NO.	SIZE	QTY/BX	LIST PRICE
ZXA1261X2A	1/8	5	
ZXA61P03	3/16	10	
ZXA1261X4A	1/4 (61P-4) DELRIN MATERIAL	10	
ZXA1261X4BR	1/4 BRASS SLV	10	
ZXA1261X5A	5/16	10	
ZXA1261X6A	3/8	10	
ZXA1261X8A	1/2	5	

## POLY FLOW FITTING NUT

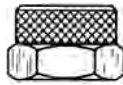

Line: 515-00

PART NO.	SIZE	QTY/BX	LIST PRICE
ZYA261U01	1/16	10	
ZYA261U02	1/8 (61PN-2)	10	
ZYA261U03	3/16 (61PN-3)	10	
ZYA1261X4	1/4 (61PN-4)	10	
ZYA1261X5	5/16 (61PN-5)	10	
ZYA1261X6	3/8 (61PN-6)	10	
ZYA1261X8	1/2 (61PN-8)	5	

## POLY FLOW FITTING UNION

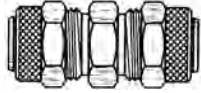

Line: 516-00

PART NO.	SIZE	QTY/BX	LIST PRICE
ZZA1262X4	1/4 62P-4	5	
ZZA1262X5	5/16 62P-5	5	
ZZA1262X6	3/8 62P-6	5	
ZZA262P02	1/8 62P-2	5	
ZZA262P03	3/16 62P-3	5	
ZZA262P08	1/2 62P-8	5	

## POLY FLOW TO COMPRESSION UNION

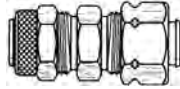

Line: 517-00

PART NO.	SIZE	QTY/BX	LIST PRICE
AAB62PC04	1/4	5	
AAB62PC5	5/16	5	
AAB62PC06	3/8	5	

## COMP/POLY FLOW BULK HEAD UNION



Line: 517-01

PART NO.	SIZE	QTY/BX	LIST PRICE
BMR62PCABH4	1/4 T SIZE	5	
BMR62PCABH6	3/8 T SIZE	5	

## POLY FLOW FITTING UNION TEE



Line: 519-00

PART NO.	SIZE	QTY/BX	LIST PRICE
ACB264P02	1/8	5	
ACB264P03	3/16	5	
ACB1264X4	1/4	5	
ACB1264X5	5/16	5	
ACB1264X6	3/8	5	
ACB264P08	1/2	5	

## POLY FLOW BULK HEAD UNION

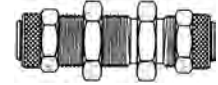

Line: 520-00

PART NO.	SIZE	QTY/BX	LIST PRICE
ADB1274X4	1/4	5	
ADB1274X5	5/16	5	
ADB1274X6	3/8	5	
ADB1274X8	1/2	5	

## POLY FLOW FITTING FEMALE CONN

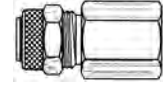

Line: 521-00

PART NO.	SIZE	QTY/BX	LIST PRICE
AKB266P0202	1/8 X 1/8	5	
AKB266P0302	3/16 X 1/8	5	
AKB1266X4	1/4 X 1/8	5	
AKB1266X4X4	1/4 X 1/4	5	
AKB1266X5	5/16 X 1/8	5	
AKB1266X5X4	5/16 X 1/4	5	
AKB1266X6	3/8 X 1/4	5	
AKB1266X6X2	3/8 X 1/8	5	
AKB1266X8	1/2 X 3/8	5	

## POLY FLOW FITTING MALE CONN



Line: 522-00

PART NO.	SIZE	QTY/BX	LIST PRICE
ALB268P0201	1/8 X 1/16	5	
ALB268P0202	1/8 X 1/8	5	
ALB268P0302	3/16 X 1/8	5	
ALB268P0401	1/4 X 1/16	5	
ALB1268X4	1/4 X 1/8	5	
ALB1268X4X4	1/4 X 1/4	5	
ALB1268X4X6	1/4 X 3/8	5	
ALB1268X5	5/16 X 1/8	5	
ALB1268X5X4	5/16 X 1/4	5	
ALB1268X6X2	3/8 X 1/8	5	
ALB1268X6	3/8 X 1/4	5	
ALB1268X6X6	3/8 X 3/8	5	
ALB1268X8	1/2 X 3/8	5	

## POLY FLOW FITTING MALE ELBOW

Line: 523-00



PART NO.	SIZE	QTY/BX	LIST PRICE
AMB269P0201	1/8 X 1/16	5	
AMB269P0202	1/8 X 1/8	5	
AMB269P0302	3/16 X 1/8	5	
AMB269P0401	1/4 X 1/16	5	
AMB1269X4	1/4 X 1/8	5	
AMB1269X4X4	1/4 X 1/4	5	
AMB1269X4X6	1/4 X 3/8	5	
AMB1269X5	5/16 X 1/8	5	
AMB1269X5X4X	5/16 X 1/4	5	
AMB1269X6	3/8 X 1/4	5	
AMB1269X6X2	3/8 X 1/8	5	
AMB1269X6X6	3/8 X 3/8	5	
AMB1269X8	1/2 X 3/8	5	

## POLY FLOW FITTING FEMALE ELBOW

Line: 524-00

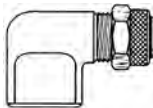

PART NO.	SIZE	QTY/BX	LIST PRICE
ANB270P0202	1/8 X 1/8	5	
ANB270P0302	3/16 X 1/8	5	
ANB1270X4	1/4 X 1/8	5	
ANB1270X4X4	1/4 X 1/4	5	
ANB1270X5	5/16 X 1/8	5	
ANB1270X6	3/8 X 1/4	5	
ANB1270X8	1/2 X 3/8	5	

## POLY FLOW FITTING MALE RUN TEE

Line: 525-00



PART NO.	SIZE	QTY/BX	LIST PRICE
APB271P0202	1/8 X 1/8	5	
APB271P0302	3/16 X 1/8	5	
APB1271X4	1/4 X 1/8	5	
APB1271X4X4X4	1/4 X 1/4	5	
APB1271X5	5/16 X 1/8	5	
APB1271X6	3/8 X 1/4	5	
APB1271X8	1/2 X 3/8	5	

## POLY FLOW FITTING MALE BRANCH TEE

Line: 526-00

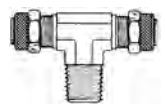

PART NO.	SIZE	QTY/BX	LIST PRICE
ARB272P0202	1/8 X 1/8	5	
ARB272P0302	3/16 X 1/8	5	
ARB1272X4	1/4 X 1/8	5	
ARB1272X4X4X4	1/4 X 1/4	5	
ARB1272X5	5/16 X 1/8	5	
ARB1272X6	3/8 X 1/4	5	
ARB272P0602	3/8 X 1/8	5	
ARB1272X8	1/2 X 3/8	5	

## POLY FLOW FITTING FEMALE BRANCH TEE

Line: 527-00

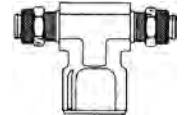

PART NO.	SIZE	QTY/BX	LIST PRICE
ASB277P04X02	1/4 X 1/8	5	
ASB277P04X04	1/4 X 1/4	5	
ASB277P04X06	1/4 X 3/8	5	

## POLY FLOW REDUCING UNION

Line: 528-00

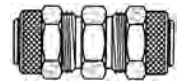

PART NO.	SIZE	QTY/BX	LIST PRICE
ATB256P06X04	3/8 X 1/4	5	

## POLY FLOW REDUCING UNION TEE

Line: 530-00

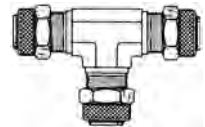

PART NO.	SIZE	QTY/BX	LIST PRICE
AVB279P06X6X4	3/8 X 3/8 X 1/4	5	

## POLY FLOW PLASTIC CAP

Line: 531-00

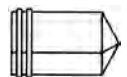

PART NO.	SIZE	QTY/BX	LIST PRICE
AWB224	1/4	10	
AWB59P5	5/16	10	
AWB226	3/8	10	
AWB50P8	1/2	10	

## 7000 SERIES ERMETO STEEL NUT

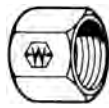

Line: 550-03

PART NO.	SIZE	QTY/BX	LIST PRICE
JZWML7105X6L	M6 T (M12-1.5 THD)	10	
JZWMH7105X6H	M6 T (M14-1.5 THD)	10	
JZWML7105X8L	M8 T (M14-1.5 THD)	10	
JZWMH7105X8H	M8 T (M16-1.5 THD)	10	
JZWMH7105X10H	M10 T (M18-1.5 THD)	10	
JZWML7105X10	M10 T (M16-1.5 THD)	10	
JZWMH7105X12H	M12 T (M20-1.5 THD)	10	
JZWML7105X12L	M12 T (M18-1.5 THD)	10	
JZWMH7105X14H	M14 T (M22-1.5 THD)	10	
JZWML7105X15L	M15 T (M22-1.5 THD)	10	
JZWMH7105X16H	M16 T (M24-1.5 THD)	10	
JZWML7105X18L	M18 T (M26-1.5 THD)	10	
JZWMH7105X20H	M20 T (M30-2.0 THD)	5	
JZWML7105X22L	M22 T (M30-2.0 THD)	5	
JZWMH7105X25H	M25 T (M36-2.0 THD)	5	
JZWML7105X28L	M28 T (M36-2.0 THD)	5	
JZWMH7105X30H	M30 T (M42-2.0 THD)	5	
JZW7105X4	1/4	5	
JZW7105X5	5/16	5	
JZW7105X6	3/8	5	
JZW7105X8	1/2	5	
JZW7105X10	5/8	5	
JZW7105X12	3/4	5	
JZW7105X14	7/8	5	
JZW7105X16	1	5	

**NOTE: ALL ERMETO STYLE FITTINGS ARE DESIGNED FOR HIGH PRESSURE APPLICATIONS WITH STEEL TUBING.**

## 7000 SERIES ERMETO STEEL SLEEVE



Line: 550-04

PART NO.	SIZE	QTY/BX	LIST PRICE
JAX7165X6M	M6 TUBE SIZE	10	
JAX7165X8M	M8 TUBE SIZE	10	
JAX7165X10MM	M10 TUBE SIZE	10	
JAX7165X12M	M12 TUBE SIZE	10	
JAX7165X14M	M14 TUBE SIZE	10	
JAX7165X15M	M15 TUBE SIZE	10	
JAX7165X16M	M16 TUBE SIZE	10	
JAX7165X18M	M18 TUBE SIZE	10	
JAX7165X20M	M20 TUBE SIZE	5	
JAX7165X22M	M22 TUBE SIZE	5	
JAX7165X25M	M25 TUBE SIZE	5	
JAX7165X28M	M28 TUBE SIZE	5	
JAX7165X30M	M30 TUBE SIZE	5	
JAX7165X2	1/8	5	
JAX7165X4	1/4	5	
JAX7165X5	5/16	5	
JAX7165X6	3/8	5	
JAX7165X8	1/2	5	
JAX7165X10	5/8	5	
JAX7165X12	3/4	5	
JAX7165X14	7/8	5	
JAX7165X16	1	5	

## 7000 SERIES ERMETO STEEL CAP

Line: 550-05



PART NO.	SIZE	QTY/BX	LIST PRICE
JBX7129X4	1/4	5	
JBX7129X6	3/8	5	
JBX7129X8	1/2	5	
JBX7129X10	5/8	5	
JBX7129X12	3/4	5	
JBX7129X16	1	5	

## 7000 SERIES ERMETO STEEL PLUG

Line: 550-06



PART NO.	SIZE	QTY/BX	LIST PRICE
JCX7229X4	1/4	5	
JCX7229X5	5/16	5	
JCX7229X6	3/8	5	
JCX7229X8	1/2	5	
JCX7229X10	5/8	5	
JCX7229X12	3/4	5	
JCX7229X16	1	5	

## ERMETO STEEL BULK HEAD NUT

7000 SERIES

Line: 550-07



PART NO.	SIZE	QTY/BX	LIST PRICE
JDX7924X4	1/4	5	
JDX7924X6	3/8	5	
JDX7924X8	1/2	5	
JDX7924X10	5/8	5	
JDX7924X12	3/4	5	
JDX7924X16	1	5	

## ERMETO STEEL MALE CONNECTOR

7000 SERIES

Line: 550-08

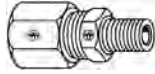

PART NO.	SIZE	QTY/BX	LIST PRICE
JEX7205X4	1/4 X 1/8	5	
JEX7205X4X4	1/4 X 1/4	5	
JEX7205X5	5/16 X 1/8	5	
JEX7205X5X4	5/16 X 1/4	5	
JEX7205X6	3/8 X 1/4	5	
JEX7205X6X2	3/8 X 1/8	5	
JEX7205X6X6	3/8 X 3/8	5	
JEX7205X6X8	3/8 X 1/2	1	
JEX7205X8X4	1/2 X 1/4	5	
JEX7205X8	1/2 X 3/8	5	
JEX7205X8X8	1/2 X 1/2	5	
JEX7205X10X6	5/8 X 3/8	5	
JEX7205X10	5/8 X 1/2	5	
JEX7205X12X8	3/4 X 1/2	5	
JEX7205X12	3/4 X 3/4	5	
JEX7205X14	7/8 X 3/4	5	
JEX7205X16X12	1 X 3/4	5	
JEX7205X16	1 X 1	5	

## ERMETO STEEL FEMALE CONNECTOR

7000 SERIES

Line: 550-09

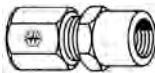

PART NO.	SIZE	QTY/BX	LIST PRICE
JFX7255X4	1/4 X 1/8	5	
JFX7255X4X4	1/4 X 1/4	5	
JFX7255X5	5/16 X 1/8	5	
JFX7255X6	3/8 X 1/4	5	
JFX7255X6X6	3/8 X 3/8	5	
JFX7255X84	1/2 X 1/4	5	
JFX7255X8	1/2 X 3/8	5	
JFX7255X8X8	1/2 X 1/2	5	
JFX7255X10	5/8 X 1/2	5	
JFX7255X12	3/4 X 3/4	5	
JFX7255X14	7/8 X 3/4	5	
JFX7255X16	1 X 1	5	

## ERMETO STEEL UNION

7000 SERIES

Line: 550-10

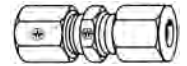

PART NO.	SIZE	QTY/BX	LIST PRICE
JGX7305X4	1/4	5	
JGX7305X5	5/16	5	
JGX7305X6	3/8	5	
JGX7305X6X4	3/8 X 1/4	5	
JGX7305X8	1/2	5	
JGX7305X8X6	1/2 X 3/8	5	
JGX7305X10	5/8	5	
JGX7305X12	3/4	5	
JGX7305X14	7/8	5	
JGX7305X16	1	5	

## ERMETO STEEL 45° MALE ELBOW

7000 SERIES

Line: 550-11



PART NO.	SIZE	QTY/BX	LIST PRICE
JHX7355X4	1/4 X 1/8	5	
JHX7355X4X4	1/4 X 1/4	5	
JHX7355X5	5/16 X 1/8	5	
JHX7355X6	3/8 X 1/4	5	
JHX7355X8	1/2 X 3/8	5	
JHX7355X10	5/8 X 1/2	5	
JHX7355X12	3/4 X 3/4	5	
JHX7355X16	1 X 1	5	

## ERMETO STEEL 90° MALE ELBOW

7000 SERIES

Line: 550-12



PART NO.	SIZE	QTY/BX	LIST PRICE
JJX7405X4	1/4 X 1/8	5	
JJX7405X4X4	1/4 X 1/4	5	
JJX7405X5	5/16 X 1/8	5	
JJX7405X5X4	5/16 X 1/4	5	
JJX7405X6X2	3/8 X 1/8	5	
JJX7405X6	3/8 X 1/4	5	
JJX405X6X8	3/8 X 1/2	5	
JJX7405X6X6	3/8 X 3/8	5	
JJX7405X8X4	1/2 X 1/4	5	
JJX7405X8	1/2 X 3/8	5	
JJX7405X8X8	1/2 X 1/2	5	
JJX7405X10X6	5/8 X 3/8	5	
JJX7405X10	5/8 X 1/2	5	
JJX7405X12X8	3/4 X 1/2	5	
JJX7405X12	3/4 X 3/4	5	
JJX7405X14	7/8 X 3/4	5	
JJX7405X16X12	1 X 3/4	5	
JJX7405X16	1 X 1	5	



### ERMETO STEEL 90° FEMALE ELBOW

7000 SERIES  
Line: 550-13

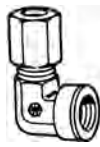

PART NO.	SIZE	QTY/BX	LIST PRICE
JKX7455X4	1/4 X 1/8	5	
JKX7455X4X4	1/4 X 1/4	5	
JKX7455X6	3/8 X 1/4	5	
JKX7455X6X6	3/8 X 3/8	5	
JKX7455X8	1/2 X 3/8	5	
JKX7455X8X8	1/2 X 1/2	5	
JKX7455X10	5/8 X 1/2	5	
JKX7455X12	3/4 X 3/4	5	
JKX7455X14	7/8 X 3/4	5	
JKX7455X16	1 X 1	5	

### ERMETO STEEL UNION ELBOW

7000 SERIES  
Line: 550-14



PART NO.	SIZE	QTY/BX	LIST PRICE
JLX7505X4	1/4	5	
JLX7505X5	5/16	5	
JLX7505X6	3/8	5	
JLX7505X8	1/2	5	
JLX7505X10	5/8	5	
JLX7505X12	3/4	5	
JLX7505X14	7/8	5	
JLX7505X16	1	5	

### ERMETO STEEL MALE BRANCH TEE

7000 SERIES  
Line: 550-15

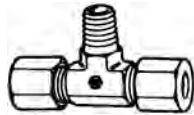

PART NO.	SIZE	QTY/BX	LIST PRICE
JMX7605X4	1/4 X 1/8	5	
JMX7605X4X4X4	1/4 X 1/4	5	
JMX7605X5	5/16 X 1/8	5	
JMX7605X6	3/8 X 1/4	5	
JMX7605X8	1/2 X 3/8	5	
JMX7605X8X8X8	1/2 X 1/2	5	
JMX7605X10	5/8 X 1/2	5	
JMX7605X12	3/4 X 3/4	5	
JMX7605X16	1 X 1	5	

### ERMETO STEEL UNION TEE

7000 SERIES  
Line: 550-16

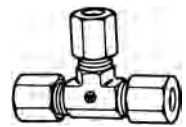

PART NO.	SIZE	QTY/BX	LIST PRICE
JNX7705X4	1/4	5	
JNX7705X5	5/16	5	
JNX7705X6	3/8	5	
JNX7705X8	1/2	5	
JNX7705X10	5/8	5	
JNX7705X12	3/4	5	
JNX7705X14	7/8	5	
JNX7705X16	1	5	

### ERMETO STEEL MALE RUN TEE

7000 SERIES  
Line: 550-17

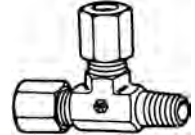

PART NO.	SIZE	QTY/BX	LIST PRICE
JPX7755X4	1/4 X 1/8	5	
JPX7755X4X4X4	1/4 X 1/4	5	
JPX7755X6	3/8 X 1/4	5	
JPX7755X8	1/2 X 3/8	5	
JPX7755X8X8X8	1/2 X 1/2	5	
JPX7755X10	5/8 X 1/2	5	
JPX7755X12	3/4 X 3/4	5	
JPX7755X16	1 X 1	5	

### ERMETO STANDARD DIESEL NUT

8000 SERIES - ZINC PLATED  
Line: 550-19

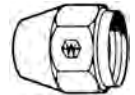

PART NO.	SIZE	QTY/BX	LIST PRICE
JSX8112X4	1/4 X 9/16-18	5	
JSX8112X5	5/16 X 5/8-18	5	
JSX8112X6	3/8 X 3/4-16	5	

### ERMETO DIESEL NUT SLEEVE

8000 SERIES - ZINC PLATED  
Line: 550-20



PART NO.	SIZE	QTY/BX	LIST PRICE
JTX8165X4	1/4	5	
JTX8165X5	5/16	5	
JTX8165X6	3/8	5	

## ERMETO FEMALE BRANCH TEE

7000 SERIES

Line: 550-22

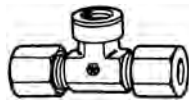

PART NO.	SIZE	QTY/BX	LIST PRICE
AGD7655X4	1/4 X 1/8	5	
AGD7655X444	1/4 X 1/4	5	
AGD7655X6	3/8 X 1/4	5	
AGD7655X8	1/2 X 3/8	1	
AGD7655X10	5/8 X 1/2	5	
AGD7655X12	3/4 X 3/4	5	
AGD7655X14	7/8 X 3/4	5	
AGD7655X16	1 X 1	5	

## FERULOK O-RING MALE CONNECTOR

Line: 550-50

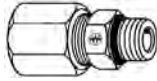

PART NO.	SIZE	QTY/BX	LIST PRICE
ARD4F5BUS	1/4 X 7/16-20	2	
ARD45F5BUS	1/4 X 1/2-20	2	
ARD46F5BUS	1/4 X 9/16-18	2	
ARD5F5BUS	5/16 X 1/2-20	2	
ARD6F5BUS	3/8 X 9/16-18	2	
ARD68F5BUS	3/8 X 3/4-16	2	
ARD8F5BUS	1/2 X 3/4-16	2	
ARD810F5BUS	1/2 X 7/8	2	
ARD812F5BUS	1/2 X 1 1/16-12	2	
ARD86F5BUS	1/2 X 9/16-18	2	
ARD10F5BUS	5/8 X 7/8-14	2	
ARD12F5BUS	3/4 X 1 1/16-12	2	
ARD1216F5BUS	3/4 X 1 5/16-12	2	
ARD1612F5BUS	1 X 1 1/16-12	1	
ARD16F5BUS	1 X 1 5/16-12	1	

## FERULOK O-RING MALE ELBOW

Line: 550-51



PART NO.	SIZE	QTY/BX	LIST PRICE
ARE4C5BUS	1/4 X 7/16-20	2	
ARE5C5BUS	5/16 X 1/2-20	2	
ARE6C5BUS	3/8 X 9/16-18	2	
ARE8C5BUS	1/2 X 3/4-16	2	
ARE10C5BUS	5/8 X 7/8-14	2	
ARE12C5BUS	3/4 X 1 1/16-12	2	
ARE16C5BUS	1 X 1 5/16-12	1	

## FERULOK O-RING 45° MALE ELBOW

Line: 550-52

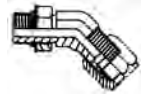

PART NO.	SIZE	QTY/BX	LIST PRICE
ARF4V5BUS	1/4 X 7/16-20	2	
ARF6V5BUS	3/8 X 9/16-18	2	
ARF8V5BUS	1/2 X 3/4-16	2	
ARF12V5BUS	3/4 X 1 1/16-12	2	
ARF16V5BUS	1 X 1 5/16-12	1	

## FERULOK O-RING STRA THRD RUN TEE

Line: 550-53

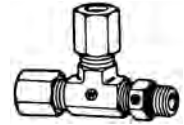

PART NO.	SIZE	QTY/BX	LIST PRICE
ARG4R5BUS	1/4 X 7/16-20	2	
ARG6R5BUS	3/8 X 9/16-18	2	
ARG8R5BUS	1/2 X 3/4-16	2	
ARG12R5BUS	3/4 X 1 1/16-12	2	

## FERULOK O-RING STRA THRD BRANCH TEE

Line: 550-54

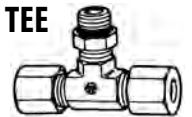

PART NO.	SIZE	QTY/BX	LIST PRICE
ARH4S5BUS	1/4 X 7/16-20	2	
ARH6S5BUS	3/8 X 9/16-18	2	
ARH8S5BUS	1/2 X 3/4-16	2	
ARH12S5BUS	3/4 X 1 1/16-12	2	

## FERULOK SWIVEL NUT 90° ELBOW

Line: 550-55

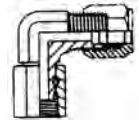

PART NO.	SIZE	QTY/BX	LIST PRICE
ARJ6C6BUS	3/8-T X 9/16-18 SV	2	
ARJ8C6BUS	1/2-T X 3/4-16 SV	2	
ARJ12C6BUS	3/4-T X 1 1/16-12 SV	2	

## FERULOK SWIVEL NUT RUN TEE

Line: 550-56

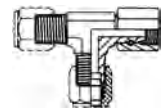

PART NO.	SIZE	QTY/BX	LIST PRICE
ARK6R6BUS	3/8-T X 9/16-18 SV	2	
ARK8R6BUS	1/2-T X 3/4-16 SV	2	
ARK12R6BUS	3/4-T X 1 1/16-12 SV	2	

**NOTE: FERULOK FITTINGS  
ARE PARKER EQUIVALENT TO  
ERMETO FITTINGS.**

## FERULOK SWIVEL NUT BRANCH TEE

Line: 550-57

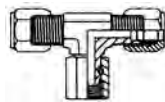

PART NO.	SIZE	QTY/BX	LIST PRICE
ARL6S6BUS	3/8-T X 9/16-18 SV	2	
ARL8S6BUS	1/2-T X 3/4-16 SV	2	
ARL12S6BUS	3/4-T X 1 1/16-12 SV	1	

## STEEL BRAKE LINES - INVERTED FLARE

WITH NUTS

Line: 551-00



PART NO.	SIZE	QTY/BX	LIST PRICE
ZLAS306	3/16 X 6 INCH LENGTH	1	
ZLAS308	3/16 X 8 INCH LENGTH	1	
ZLAS310	3/16 X 10 INCH LENGTH	1	
ZLAS312	3/16 X 12 INCH LENGTH	1	
ZLAS320	3/16 X 20 INCH LENGTH	1	
ZLAS330	3/16 X 30 INCH LENGTH	1	
ZLAS340	3/16 X 40 INCH LENGTH	1	
ZLAS351	3/16 X 51 INCH LENGTH	1	
ZLAS360	3/16 X 60 INCH LENGTH	1	
ZLAS372	3/16 X 72 INCH LENGTH	1	
ZLAS408	1/4 X 8 INCH LENGTH	1	
ZLAS412	1/4 X 12 INCH LENGTH	1	
ZLAS420	1/4 X 20 INCH LENGTH	1	
ZLAS430	1/4 X 30 INCH LENGTH	1	
ZLAS440	1/4 X 40 INCH LENGTH	1	
ZLAS451	1/4 X 51 INCH LENGTH	1	
ZLAS460	1/4 X 60 INCH LENGTH	1	
ZLAS512	5/16 X 12 INCH LENGTH	1	
ZLAS520	5/16 X 20 INCH LENGTH	1	
ZLAS530	5/16 X 30 INCH LENGTH	1	
ZLAS540	5/16 X 40 INCH LENGTH	1	
ZLAS551	5/16 X 51 INCH LENGTH	1	
ZLAS560	5/16 X 60 INCH LENGTH	1	
ZLAS612	3/8 X 12 INCH LENGTH	1	
ZLAS620	3/8 X 20 INCH LENGTH	1	
ZLAS630	3/8 X 30 INCH LENGTH	1	
ZLAS640	3/8 X 40 INCH LENGTH	1	
ZLAS651	3/8 X 51 INCH LENGTH	1	
ZLAS660	3/8 X 60 INCH LENGTH	1	
ZLAS672	3/8 X 72 INCH LENGTH	1	
ZLABA-48X	12SZ RACK FOR S3 & S4 LINES	1	

**NOTE:** BEGINNING WITH LINE #551-25, THIS PRODUCT IS A HIGH VALUE BRASS TUBE FITTING PRICED VERY COMPETITIVELY FOR NON-BRAND REQUIREMENTS

## STL BRAKE LINES BRITISH BUBBLE FLARE

Line: 551-01



PART NO.	SIZE	QTY/BX	LIST PRICE
JUXSB308	3/8-24 X 8 INCH LENGTH	1	
JUXSB312	3/8-24 X 12 INCH LENGTH	1	
JUXSB320	3/8-24 X 20 INCH LENGTH	1	
JUXSB330	3/8-24 X 30 INCH LENGTH	1	
JUXSB340	3/8-24 X 40 INCH LENGTH	1	
JUXSB351	3/8-24 X 51 INCH LENGTH	1	
JUXSB360	3/8-24 X 60 INCH LENGTH	1	
JUX7940	3/8-24ISO FLARE UNION	5	

## STL BRAKE LINES EUROPEAN BUBBLE FLARE

Line: 551-02



PART NO.	SIZE	QTY/BX	LIST PRICE
JVXSC308	10-1.0MM X 8 INCH LENGTH	1	
JVXSC312	10-1.0MM X 12 INCH LENGTH	1	
JVXSC320	10-1.0MM X 20 INCH LENGTH	1	
JVXSC330	10-1.0MM X 30 INCH LENGTH	1	
JVXSC340	10-1.0MM X 40 INCH LENGTH	1	
JVXSC351	10-1.0MM X 51 INCH LENGTH	1	
JVXSC360	10-1.0MM X 60 INCH LENGTH	1	
JVX7941	10-1.0 BULB FLARE UNION	5	

## STL BRAKE LINES JAPAN STD FLARE

Line: 551-03



PART NO.	SIZE	QTY/BX	LIST PRICE
JWXSJ308	10-1.0MM X 8 INCH LENGTH	1	
JWXSJ312	10-1.0MM X 12 INCH LENGTH	1	
JWXSJ320	10-1.0MM X 20 INCH LENGTH	1	
JWXSJ330	10-1.0MM X 30 INCH LENGTH	1	
JWXSJ340	10-1.0MM X 40 INCH LENGTH	1	
JWXSJ351	10-1.0MM X 51 INCH LENGTH	1	
JWXSJ360	10-1.0MM X 60 INCH LENGTH	1	
JWX7934	10-1.0MM UNION	1	

## STD SAE FLARE REG NUT BRASS N1

Line: 551-25

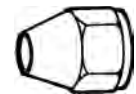

PART NO.	SIZE	QTY/BX	LIST PRICE
BUDN12	1/8	10	
BUDN13	3/16	10	
BUDN14	1/4	10	
BUDN15	5/16	10	
BUDN16	3/8	10	
BUDN18	1/2	10	
BUDN110	5/8	5	
BUDN112	3/4	5	

## SAE FLARE LONG NUT BRASS N2

BRASS FITTING

Line: 551-26

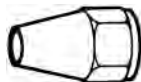

PART NO.	SIZE	QTY/BX	LIST PRICE
BUEN23	3/16	10	
BUEN24	1/4	10	
BUEN25	5/16	10	
BUEN26	3/8	10	
BUEN28	1/2	10	
BUEN210	5/8	5	

## SAE FLARE CAP BRASS N5

BRASS FITTING

Line: 551-27

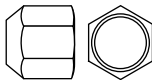

PART NO.	SIZE	QTY/BX	LIST PRICE
BUFN53	3/16	10	
BUFN54	1/4	10	
BUFN55	5/16	10	
BUFN56	3/8	10	
BUFN58	1/2	5	
BUFN510	5/8	5	
BUFN512	3/4	5	

## SAE FLARE PLUG BRASS P2

BRASS FITTING

Line: 551-28

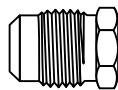

PART NO.	SIZE	QTY/BX	LIST PRICE
BUGP23	3/16	10	
BUGP24	1/4	10	
BUGP25	5/16	10	
BUGP26	3/8	10	
BUGP28	1/2	10	
BUGP210	5/8	5	
BUGP212	3/4	5	

## SAE FLARE UNION BRASS U2

BRASS FITTING

Line: 551-29

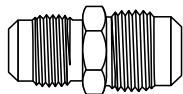

PART NO.	SIZE	QTY/BX	LIST PRICE
BUHU22	1/8	10	
BUHU23	3/16	10	
BUHU24	1/4	10	
BUHU25	5/16	10	
BUHU26	3/8	10	
BUHU28	1/2	5	
BUHU210	5/8	5	
BUHU212	3/4	5	

## SAE FLARE RED UNION BRASS UR2

Line: 551-30

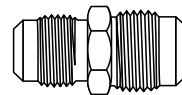

PART NO.	SIZE	QTY/BX	LIST PRICE
BUJUR264	3/8 X 1/4	10	
BUJUR284	1/2 X 1/4	10	
BUJUR286	1/2 X 3/8	10	
BUJUR2106	5/8 X 3/8	5	
BUJUR2108	5/8 X 1/2	5	
BUJUR2128	3/4 X 1/2	5	

## SAE FLARE MALE X FEM BRASS UR3

Line: 551-31

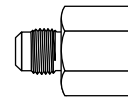

PART NO.	SIZE	QTY/BX	LIST PRICE
BUKUR346	F1/4 X M3/8	5	
BUKUR364	F3/8 X M1/4	5	
BUKUR368	F3/8 X M1/2	5	
BUKUR3810	F1/2 X M5/8	5	
BUKUR386	F1/2 X M3/8	5	
BUKUR3108	F5/8 X M1/2	5	

## SAE FLARE MALE CONN BRASS U1

Line: 551-32

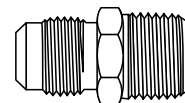

PART NO.	SIZE	QTY/BX	LIST PRICE
BULU12A	1/8 X 1/8	5	
BULU13A	3/16 X 1/8	10	
BULU14A	1/4 X 1/8	10	
BULU14B	1/4 X 1/4	10	
BULU14C	1/4 X 3/8	10	
BULU14D	1/4 X 1/2	5	
BULU15A	5/16 X 1/8	10	
BULU15B	5/16 X 1/4	10	
BULU15C	5/16 X 3/8	5	
BULU16A	3/8 X 1/8	10	
BULU16B	3/8 X 1/4	10	
BULU16C	3/8 X 3/8	10	
BULU16D	3/8 X 1/2	10	
BULU16E	3/8 X 3/4	5	
BULU18B	1/2 X 1/4	5	
BULU18C	1/2 X 3/8	5	
BULU18D	1/2 X 1/2	5	
BULU18E	1/2 X 3/4	5	
BULU110C	5/8 X 3/8	5	
BULU110D	5/8 X 1/2	5	
BULU110E	5/8 X 3/4	5	
BULU112D	3/4 X 1/2	5	
BULU112E	3/4 X 3/4	5	

## SAE FLARE MALE ELBOW BRASS E1

Line: 551-33

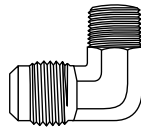

PART NO.	SIZE	QTY/BX	LIST PRICE
BUME12A	1/8 X 1/8	5	
BUME13A	3/16 X 1/8	10	
BUME13B	3/16 X 1/4	5	
BUME14A	1/4 X 1/8	10	
BUME14B	1/4 X 1/4	10	
BUME14C	1/4 X 3/8	10	
BUME14D	1/4 X 1/2	5	
BUME15A	5/16 X 1/8	10	
BUME15B	5/16 X 1/4	10	
BUME15C	5/16 X 3/8	5	
BUME16A	3/8 X 1/8	10	
BUME16B	3/8 X 1/4	10	
BUME16C	3/8 X 3/8	10	
BUME16D	3/8 X 1/2	10	
BUME16E	3/8 X 3/4	5	
BUME18B	1/2 X 1/4	5	
BUME18C	1/2 X 3/8	5	
BUME18D	1/2 X 1/2	5	
BUME18E	1/2 X 3/4	5	
BUME110C	5/8 X 3/8	5	
BUME110D	5/8 X 1/2	5	
BUME110E	5/8 X 3/4	5	
BUME112C	3/4 X 3/8	5	
BUME112D	3/4 X 1/2	5	
BUME112E	3/4 X 3/4	5	
BUME116E	1 X 3/4	5	

## SAE FLARE FEMALE CONN BRASS U3

Line: 551-34

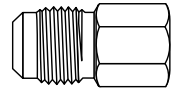

PART NO.	SIZE	QTY/BX	LIST PRICE
BUNU32A	1/8 X 1/8	5	
BUNU33A	3/16 X 1/8	5	
BUNU34A	1/4 X 1/8	10	
BUNU34B	1/4 X 1/4	10	
BUNU34C	1/4 X 3/8	10	
BUNU35A	5/16 X 1/8	10	
BUNU35B	5/16 X 1/4	10	
BUNU36A	3/8 X 1/8	10	
BUNU36B	3/8 X 1/4	10	
BUNU36C	3/8 X 3/8	10	
BUNU36D	3/8 X 1/2	5	
BUNU36E	3/8 X 3/4	5	
BUNU38B	1/2 X 1/4	5	
BUNU38C	1/2 X 3/8	5	
BUNU38D	1/2 X 1/2	5	
BUNU38E	1/2 X 3/4	5	
BUNU310C	5/8 X 3/8	5	
BUNU310D	5/8 X 1/2	5	
BUNU310E	5/8 X 3/4	5	
BUNU312D	3/4 X 1/2	5	
BUNU312E	3/4 X 3/4	5	

## SAE FLARE SWIVEL NUT UNION US4

Line: 551-35

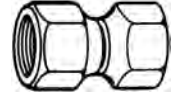

PART NO.	SIZE	QTY/BX	LIST PRICE
BUPUS44	1/4 X 1/4	10	
BUPUS45	5/16 X 5/16	10	
BUPUS46	3/8 X 3/8	10	
BUPUS48	1/2 X 1/2	10	
BUPUS410	5/8 X 5/8	5	
BUPUS412	3/4 X 3/4	5	

### SAE FLARE FEMALE ELBOW BRASS E3

Line: 551-36



PART NO.	SIZE	QTY/BX	LIST PRICE
BURE34A	1/4 X 1/8	10	
BURE34B	1/4 X 1/4	10	
BURE35A	5/16 X 1/8	10	
BURE35B	5/16 X 1/4	10	
BURE36A	3/8 X 1/8	10	
BURE36B	3/8 X 1/4	10	
BURE36C	3/8 X 3/8	10	
BURE36D	3/8 X 1/2	10	
BURE36E	3/8 X 3/4	5	
BURE38B	1/2 X 1/4	5	
BURE38C	1/2 X 3/8	5	
BURE38D	1/2 X 1/2	5	
BURE38E	1/2 X 3/4	5	
BURE310C	5/8 X 3/8	5	
BURE310D	5/8 X 1/2	5	
BURE310E	5/8 X 3/4	5	
BURE312D	3/4 X 1/2	5	
BURE312E	3/4 X 3/4	5	

### SAE FLARE 45° MALE ELBOW BRASS E145

Line: 551-37

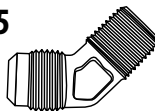

PART NO.	SIZE	QTY/BX	LIST PRICE
BUTE1454A	1/4 X 1/8	10	
BUTE1454B	1/4 X 1/4	10	
BUTE1455A	5/16 X 1/8	10	
BUTE1455B	5/16 X 1/4	10	
BUTE1456B	3/8 X 1/4	10	
BUTE1456C	3/8 X 3/8	10	
BUTE1456D	3/8 X 1/2	10	
BUTE1458C	1/2 X 3/8	5	
BUTE1458D	1/2 X 1/2	5	
BUTE14510C	5/8 X 3/8	5	
BUTE14510D	5/8 X 1/2	5	
BUTE14512D	3/4 X 1/2	5	
BUTE14512E	3/4 X 3/4	5	

### SAE FLARE UNION TEE BRASS T2

Line: 551-38

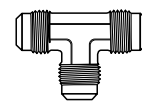

PART NO.	SIZE	QTY/BX	LIST PRICE
BUVT23	3/16	10	
BUVT24	1/4	10	
BUVT25	5/16	10	
BUVT26	3/8	10	
BUVT28	1/2	5	
BUVT210	5/8	5	
BUVT212	3/4	5	

### SAE FLARE RED UNION TEE BRASS TR2

Line: 551-39

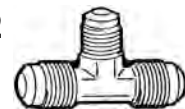

PART NO.	SIZE	QTY/BX	LIST PRICE
BUWTR2446	1/4 X 1/4 X 3/8	5	
BUWTR2664	3/8 X 3/8 X 1/4	5	
BUWTR2668	3/8 X 3/8 X 1/2	5	
BUWTR2886	1/2 X 1/2 X 3/8	5	
BUWTR28810	1/2 X 1/2 X 5/8	5	
BUWTR210106	5/8 X 5/8 X 3/8	5	
BUWTR210108	5/8 X 5/8 X 1/2	5	

### SAE FLARE UNION ELBOW BRASS E2

Line: 551-40

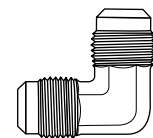

PART NO.	SIZE	QTY/BX	LIST PRICE
BUXE22	1/8	5	
BUXE23	3/16	5	
BUXE24	1/4	10	
BUXE25	5/16	10	
BUXE26	3/8	10	
BUXE28	1/2	5	
BUXE210	5/8	5	
BUXE212	3/4	5	

### SAE FLARE FORGED NUT BRASS NS4

Line: 551-41



PART NO.	SIZE	QTY/BX	LIST PRICE
BUYNS43	3/16	10	
BUYNS44	1/4	10	
BUYNS45	5/16	10	
BUYNS46	3/8	10	
BUYNS48	1/2	10	
BUYNS410	5/8	5	
BUYNS412	3/4	5	

**SAE FLARE MALE BRANCH TEE T1**

Line: 551-42

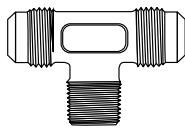

PART NO.	SIZE	QTY/BX	LIST PRICE
BUZT12A	1/8 X 1/8	5	
BUZT13A	3/16 X 3/16 X 1/8	5	
BUZT14A	1/4 X 1/4 X 1/8	5	
BUZT14B	1/4 X 1/4 X 1/4	5	
BUZT14C	1/4 X 1/4 X 3/8	5	
BUZT15A	5/16 X 5/16 X 1/8	5	
BUZT15B	5/16 X 5/16 X 1/4	5	
BUZT16A	3/8 X 3/8 X 1/8	5	
BUZT16B	3/8 X 3/8 X 1/4	5	
BUZT16C	3/8 X 3/8 X 3/8	5	
BUZT16D	3/8 X 3/8 X 1/2	5	
BUZT18B	1/2 X 1/2 X 1/4	5	
BUZT18C	1/2 X 1/2 X 3/8	5	
BUZT18D	1/2 X 1/2 X 1/2	5	
BUZT110D	5/8 X 5/8 X 1/2	5	
BUZT112D	3/4 X 1/2	5	

**SAE FLARE MALE RUN TEE T3**

Line: 551-43

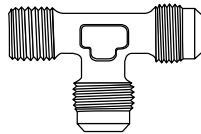

PART NO.	SIZE	QTY/BX	LIST PRICE
BVDT33A	3/16 X 3/16 X 1/8	5	
BVDT34A	1/4 X 1/4 X 1/8	5	
BVDT34B	1/4 X 1/4 X 1/4	5	
BVDT34C	1/4 X 1/4 X 3/8	5	
BVDT35A	5/16 X 5/16 X 1/8	5	
BVDT35B	5/16 X 5/16 X 1/4	5	
BVDT36A	3/8 X 3/8 X 1/8	5	
BVDT36B	3/8 X 3/8 X 1/4	5	
BVDT36C	3/8 X 3/8 X 3/8	5	
BVDT36D	3/8 X 3/8 X 1/2	5	
BVDT38B	1/2 X 1/2 X 1/4	5	
BVDT38C	1/2 X 1/2 X 3/8	5	
BVDT38D	1/2 X 1/2 X 1/2	5	
BVDT310C	5/8 X 5/8 X 3/8	5	
BVDT310D	5/8 X 5/8 X 1/2	5	
BVDT312D	3/4 X 1/2	5	

**INVERTED FLARE NUT BRASS 411B**

BRASS FITTING

Line: 551-50



PART NO.	SIZE	QTY/BX	LIST PRICE
BVE411B2	1/8	10	
BVE411B3	3/16	10	
BVE411B4	1/4	10	
BVE411B5	5/16	10	
BVE411B6	3/8	10	
BVE411B8	1/2	10	

**INVERTED FLARE UNION 421**

BRASS FITTING

Line: 551-51

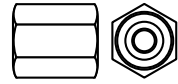

PART NO.	SIZE	QTY/BX	LIST PRICE
BVF4212	1/8	10	
BVF4213	3/16	10	
BVF4214	1/4	10	
BVF4215	5/16	10	
BVF4216	3/8	10	
BVF4218	1/2	10	

**INVERTED FLARE MALE CONN 481**

BRASS FITTING

Line: 551-52

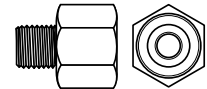

PART NO.	SIZE	QTY/BX	LIST PRICE
BVG4812A	1/8 X 1/8	10	
BVG4813A	3/16 X 1/8	10	
BVG4814A	1/4 X 1/8	10	
BVG4814B	1/4 X 1/4	10	
BVG4815A	5/16 X 1/8	10	
BVG4815B	5/16 X 1/4	5	
BVG4816A	3/8 X 1/8	10	
BVG4816B	3/8 X 1/4	10	
BVG4816C	3/8 X 3/8	5	
BVG4818B	1/2 X 1/4	5	
BVG4818C	1/2 X 3/8	10	
BVG4818D	1/2 X 1/2	5	
BVG48110D	5/8 X 1/2	5	

## INVERTED FLARE MALE ELBOW 491

BRASS FITTING

Line: 551-53

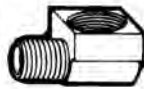

PART NO.	SIZE	QTY/BX	LIST PRICE
BVH4912A	1/8 X 1/8	10	
BVH4913A	3/16 X 1/8	10	
BVH4914A	1/4 X 1/8	10	
BVH4914B	1/4 X 1/4	10	
BVH4915A	5/16 X 1/8	10	
BVH4915B	5/16 X 1/4	5	
BVH4916A	3/8 X 1/8	10	
BVH4916B	3/8 X 1/4	10	
BVH4916C	3/8 X 3/8	5	
BVH4918B	1/2 X 1/4	5	
BVH4918C	1/2 X 3/8	10	
BVH4918D	1/2 X 1/2	5	
BVH49110D	5/8 X 1/2	5	

## INVERTED FLARE 45° MALE ELBOW 941

BRASS FITTING

Line: 551-54

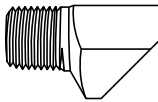

PART NO.	SIZE	QTY/BX	LIST PRICE
BVJ9413A	3/16 X 1/8	10	
BVJ9414A	1/4 X 1/8	10	
BVJ9415A	5/16 X 1/8	10	
BVJ9416B	3/8 X 1/4	10	
BVJ9418C	1/2 X 3/8	10	

## INVERTED FLARE UNION TEE 441

BRASS FITTING

Line: 551-55

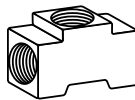

PART NO.	SIZE	QTY/BX	LIST PRICE
BVK4413	3/16	10	
BVK4414	1/4	10	
BVK4415	5/16	10	
BVK4416	3/8	10	
BVK4418	1/2	5	

## INVERTED FLARE MALE PLUG 411P

BRASS FITTING

Line: 551-56

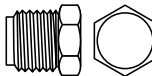

PART NO.	SIZE	QTY/BX	LIST PRICE
BVL411P3	3/16	10	
BVL411P4	1/4	10	
BVL411P5	5/16	10	
BVL411P6	3/8	10	

## INVERTED FLARE FEMALE CONN 461

BRASS FITTING

Line: 551-57

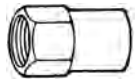

PART NO.	SIZE	QTY/BX	LIST PRICE
BVM4613A	3/16 X 1/8	10	
BVM4614A	1/4 X 1/8	10	
BVM4615A	5/16 X 1/8	10	
BVM4616B	3/8 X 1/4	10	
BVM4618C	1/2 X 3/8	5	

## COMPRESSION SHORT NUT61A

BRASS FITTING

Line: 551-60

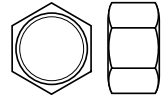

PART NO.	SIZE	QTY/BX	LIST PRICE
BVN61A2	1/8	10	
BVN61AAA	5/32	10	
BVN61A3	3/16	10	
BVN61A4	1/4	10	
BVN61A5	5/16	10	
BVN61A6	3/8	10	
BVN61A8	1/2	10	
BVN61A10	5/8	5	
BVN61A12	3/4	5	
BVN61A14	7/8	5	

## COMPRESSION SLEEVE 60A

BRASS FITTING

Line: 551-61



PART NO.	SIZE	QTY/BX	LIST PRICE
BVP60A2	1/8	50	
BVP60AAA	5/32	25	
BVP60A3	3/16	50	
BVP60A4	1/4	50	
BVP60A5	5/16	50	
BVP60A6	3/8	50	
BVP60A8	1/2	50	
BVP60A10	5/8	25	
BVP60A12	3/4	25	
BVP60A14	7/8	25	



## COMPRESSION UNION 62A

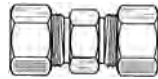

Line: 551-62

PART NO.	SIZE	QTY/BX	LIST PRICE
BVR62A22	1/8	10	
BVR62A33	3/16	10	
BVR62A44	1/4	10	
BVR62A42	1/4 X 1/8	10	
BVR62A43	1/4 X 3/16	10	
BVR62A55	5/16	10	
BVR62A54	5/16 X 1/4	10	
BVR62A66	3/8	10	
BVR62A64	3/8 X 1/4	10	
BVR62A65	3/8 X 5/16	10	
BVR62A88	1/2	10	
BVR62A86	1/2 X 3/8	5	
BVR62A1010	5/8	5	
BVR62A106	5/8 X 3/8	5	
BVR62A108	5/8 X 1/2	5	
BVR62A1212	3/4	5	
BVR62A1414	7/8	5	

## COMPRESSION UNION TEE 64A

Line: 551-63

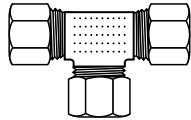

PART NO.	SIZE	QTY/BX	LIST PRICE
BVT64A22	1/8	10	
BVT64A33	3/16	10	
BVT64A44	1/4	10	
BVT64A55	5/16	10	
BVT64A66	3/8	10	
BVT64A88	1/2	10	
BVT64A1010	5/8	5	
BVT64A1212	3/4	5	
BVT64A1414	7/8	5	

## COMPRESSION MALE RUN TEE 71A



Line: 551-64

PART NO.	SIZE	QTY/BX	LIST PRICE
BVV71A2A	1/8 X 1/8	5	
BVV71A3A	3/16 X 1/8	5	
BVV71A4A	1/4 X 1/8	10	
BVV71A4B	1/4 X 1/4	10	
BVV71A5A	5/16 X 1/8	10	
BVV71A6A	3/8 X 1/8	5	
BVV71A6B	3/8 X 1/4	10	
BVV71A6C	3/8 X 3/8	10	
BVV71A8C	1/2 X 3/8	5	
BVV71A8D	1/2 X 1/2	5	
BVV71A10D	5/8 X 1/2	5	

## COMPRESSION MALE BRANCH TEE 72A

Line: 551-65

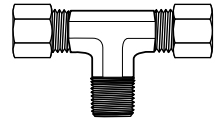

PART NO.	SIZE	QTY/BX	LIST PRICE
BVW72A2A	1/8 X 1/8	5	
BVW72A3A	3/16 X 1/8	5	
BVW72A4A	1/4 X 1/8	10	
BVW72A4B	1/4 X 1/4	10	
BVW72A5A	5/16 X 1/8	5	
BVW72A5B	5/16 X 1/4	10	
BVW72A6A	3/8 X 1/8	5	
BVW72A6B	3/8 X 1/4	10	
BVW72A6C	3/8 X 3/8	10	
BVW72A8C	1/2 X 3/8	5	
BVW72A10D	5/8 X 1/2	5	

## COMPRESSION UNION ELBOW 65A

Line: 551-66

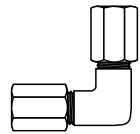

PART NO.	SIZE	QTY/BX	LIST PRICE
BVX65A22	1/8	10	
BVX65A33	3/16	10	
BVX65A44	1/4	10	
BVX65A55	5/16	10	
BVX65A66	3/8	10	
BVX65A88	1/2	5	
BVX65A1010	5/8	5	
BVX65A1212	3/4	5	
BVX65A1414	7/8	5	

**COMPRESSION MALE CONN 68A**

Line: 551-67

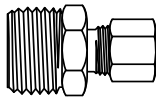

PART NO.	SIZE	QTY/BX	LIST PRICE
BVY68A2A	1/8 X 1/8	10	
BVY68A3A	3/16 X 1/8	10	
BVY68A3B	3/16 X 1/4	5	
BVY68A4A	1/4 X 1/8	10	
BVY68A4B	1/4 X 1/4	10	
BVY68A4C	1/4 X 3/8	10	
BVY68A4D	1/4 X 1/2	10	
BVY68A5A	5/16 X 1/8	10	
BVY68A5B	5/16 X 1/4	5	
BVY68A6A	3/8 X 1/8	10	
BVY68A6B	3/8 X 1/4	10	
BVY68A6C	3/8 X 3/8	10	
BVY68A6D	3/8 X 1/2	10	
BVY68A8B	1/2 X 1/4	5	
BVY68A8C	1/2 X 3/8	5	
BVY68A8D	1/2 X 1/2	5	
BVY68A8E	1/2 X 3/4	5	
BVY68A10C	5/8 X 3/8	5	
BVY68A10D	5/8 X 1/2	5	
BVY68A10E	5/8 X 3/4	5	
BVY68A12D	3/4 X 1/2	5	
BVY68A12E	3/4 X 3/4	5	

**COMPRESSION FEMALE CONN 66A**

Line: 551-68

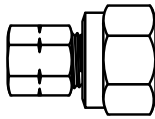

PART NO.	SIZE	QTY/BX	LIST PRICE
BVZ66A2A	1/8 X 1/8	5	
BVZ66A3A	3/16 X 1/8	5	
BVZ66A4A	1/4 X 1/8	10	
BVZ66A4B	1/4 X 1/4	10	
BVZ66A4C	1/4 X 3/8	5	
BVZ66A5A	5/16 X 1/8	5	
BVZ66A5B	5/16 X 1/4	10	
BVZ66A6A	3/8 X 1/8	5	
BVZ66A6B	3/8 X 1/4	10	
BVZ66A6C	3/8 X 3/8	5	
BVZ66A6D	3/8 X 1/2	10	
BVZ66A8B	1/2 X 1/4	5	
BVZ66A8C	1/2 X 3/8	10	
BVZ66A8D	1/2 X 1/2	5	
BVZ66A8E	1/2 X 3/4	5	
BVZ66A10D	5/8 X 1/2	5	
BVZ66A12D	3/4 X 1/2	5	
BVZ66A12E	3/4 X 3/4	5	

**COMPRESSION MALE ELBOW 69A**

Line: 551-69

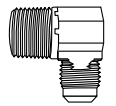

PART NO.	SIZE	QTY/BX	LIST PRICE
BWD69A2A	1/8 X 1/8	10	
BWD69A3A	3/16 X 1/8	10	
BWD69A3B	3/16 X 1/4	5	
BWD69A4A	1/4 X 1/8	10	
BWD69A4B	1/4 X 1/4	10	
BWD69A4C	1/4 X 3/8	5	
BWD69A5A	5/16 X 1/8	10	
BWD69A5B	5/16 X 1/4	5	
BWD69A6A	3/8 X 1/8	10	
BWD69A6B	3/8 X 1/4	10	
BWD69A6C	3/8 X 3/8	10	
BWD69A6D	3/8 X 1/2	5	
BWD69A8B	1/2 X 1/4	5	
BWD69A8C	1/2 X 3/8	10	
BWD69A8D	1/2 X 1/2	5	
BWD69A8E	1/2 X 3/4	5	
BWD69A10C	5/8 X 3/8	5	
BWD69A10D	5/8 X 1/2	5	
BWD69A10E	5/8 X 3/4	5	
BWD69A12D	3/4 X 1/2	5	
BWD69A12E	3/4 X 3/4	5	
BWD69A14E	7/8 X 3/4	5	

**COMPRESSION 45° MALE ELBOW 6945A**

Line: 551-70

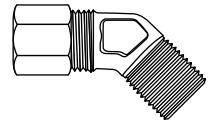

PART NO.	SIZE	QTY/BX	LIST PRICE
BWE6945A3A	3/16 X 1/8	10	
BWE6945A4A	1/4 X 1/8	10	
BWE6945A5A	5/16 X 1/8	10	
BWE6945A5B	5/16 X 1/4	5	
BWE6945A6B	3/8 X 1/4	10	
BWE6945A8C	1/2 X 3/8	10	
BWE6945A10D	5/8 X 1/2	5	

### COMPRESSION FEMALE ELBOW 70A

BRASS FITTING

Line: 551-71



PART NO.	SIZE	QTY/BX	LIST PRICE
BWF70A2A	1/8 X 1/8	5	
BWF70A3A	3/16 X 1/8	5	
BWF70A4A	1/4 X 1/8	10	
BWF70A4B	1/4 X 1/4	10	
BWF70A5A	5/16 X 1/8	10	
BWF70A5B	5/16 X 1/4	5	
BWF70A6A	3/8 X 1/8	5	
BWF70A6B	3/8 X 1/4	10	
BWF70A6C	3/8 X 3/8	10	
BWF70A6D	3/8 X 1/2	5	
BWF70A8C	1/2 X 3/8	10	
BWF70A8D	1/2 X 1/2	5	
BWF70A8E	1/2 X 3/4	5	
BWF70A10D	5/8 X 1/2	5	
BWF70A10E	5/8 X 3/4	5	
BWF70A12D	3/4 X 1/2	5	
BWF70A12E	3/4 X 3/4	5	

### IPT FEMALE ELBOW 100A

BRASS FITTING

Line: 551-80

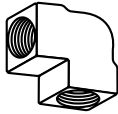

PART NO.	SIZE	QTY/BX	LIST PRICE
BWG100AA	1/8	10	
BWG100AB	1/4	10	
BWG100AC	3/8	10	
BWG100AD	1/2	5	
BWG100AE	3/4	5	

### IPT 45° FEMALE ELBOW 10045A

BRASS FITTING

Line: 551-81



PART NO.	SIZE	QTY/BX	LIST PRICE
BWH10045AA	1/8	10	
BWH10045AB	1/4	10	
BWH10045AC	3/8	10	
BWH10045AD	1/2	5	

### IPT FEMALE UNION TEE 101A

BRASS FITTING

Line: 551-82

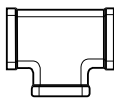

PART NO.	SIZE	QTY/BX	LIST PRICE
BWJ101AA	1/8	10	
BWJ101AB	1/4	10	
BWJ101AC	3/8	10	
BWJ101AD	1/2	5	
BWJ101AE	3/4	5	

### IPT FEMALE COUPLING 103A

BRASS FITTING

Line: 551-83

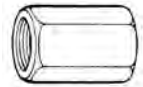

PART NO.	SIZE	QTY/BX	LIST PRICE
BWK103AA	1/8	10	
BWK103AB	1/4	10	
BWK103AC	3/8	10	
BWK103AD	1/2	5	
BWK103AE	3/4	5	

### IPT SCREWED UNION 104A

BRASS FITTING

Line: 551-84

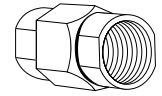

PART NO.	SIZE	QTY/BX	LIST PRICE
BWL104AA	1/8	5	
BWL104AB	1/4	5	
BWL104AC	3/8	5	
BWL104AD	1/2	5	
BWL104AE	3/4	5	

### IPT FEMALE CAP 108A

BRASS FITTING

Line: 551-85

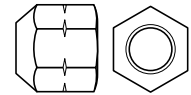

PART NO.	SIZE	QTY/BX	LIST PRICE
BWM108AA	1/8	10	
BWM108AB	1/4	10	
BWM108AC	3/8	10	
BWM108AD	1/2	10	
BWM108AE	3/4	10	

### IPT SQUARE PLUG 109A

BRASS FITTING

Line: 551-86

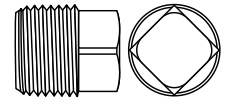

PART NO.	SIZE	QTY/BX	LIST PRICE
BWN109AA	1/8	10	
BWN109AB	1/4	10	
BWN109AC	3/8	10	
BWN109AD	1/2	10	
BWN109AE	3/4	10	
BWN109AF	1	5	

## IPT REDUCING BUSHING 110A

BRASS FITTING

Line: 551-87

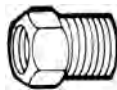

PART NO.	SIZE	QTY/BX	LIST PRICE
BWP110ABA	1/4 X 1/8	10	
BWP110ACA	3/8 X 1/8	10	
BWP110ACB	3/8 X 1/4	10	
BWP110ADA	1/2 X 1/8	10	
BWP110ADB	1/2 X 1/4	10	
BWP110ADC	1/2 X 3/8	10	
BWP110AEA	3/4 X 1/8	10	
BWP110AEB	3/4 X 1/4	10	
BWP110AEC	3/4 X 3/8	10	
BWP110AED	3/4 X 1/2	10	
BWP110AFB	1 X 1/4	5	
BWP110AFC	1 X 3/8	5	
BWP110AFD	1 X 1/2	5	
BWP110AFE	1 X 3/4	5	

## IPT LONG NIPPLE 134A

Line: 551-88



PART NO.	SIZE	QTY/BX	LIST PRICE
BWR113AA15	1/8 X 1 1/2	10	
BWR113AA2	1/8 X 2	10	
BWR113RBA25	1/8 X 2 1/2	10	
BWR113RBA3	1/8 X 3	10	
BWR113RBA4	1/8 X 4	10	
BWR113RBA5	1/8 X 5	100	
BWR113AB15	1/4 X 1 1/2	10	
BWR113AB2	1/4 X 2	10	
BWR113RBB25	1/4 X 2 1/2	10	
BWR113RBB3	1/4 X 3	10	
BWR113RBB4	1/4 X 4	10	
BWR113RBB5	1/4 X 5	10	
BWR113AC15	3/8 X 1 1/2	10	
BWR113AC2	3/8 X 2	10	
BWR113RBC25	3/8 X 2 1/2	10	
BWR113RBC3	3/8 X 3	10	
BWR113RBC35	3/8 X 3 1/2	5	
BWR113RBC4	3/8 X 4	10	
BWR113RBC5	3/8 X 5	10	
BWR113RBC6	3/8 X 6	10	
BWR113AD15	1/2 X 1 1/2	10	
BWR113AD2	1/2 X 2	10	
BWR113RBD25	1/2 X 2 1/2	10	
BWR113RBD3	1/2 X 3	10	
BWR113RBD35	1/2 X 3 1/2	5	
BWR113RBD4	1/2 X 4	5	

(continued...)

## IPT LONG NIPPLE 134A (cont.)

Line: 551-88



PART NO.	SIZE	QTY/BX	LIST PRICE
BWR113RBD45	1/2 X 4 1/2	5	
BWR113RBD5	1/2 X 5	1	
BWR113RBD6	1/2 X 6	5	
BWR113AE15	3/4 X 1 1/2	5	
BWR113AE2	3/4 X 2	5	
BWR113RBE25	3/4 X 2 1/2	5	
BWR113RBE3	3/4 X 3	5	
BWR113RBE35	3/4 X 3 1/2	5	
BWR113RBE4	3/4 X 4	5	
BWR113RBE45	3/4 X 4 1/2	5	
BWR113RBE5	3/4 X 5	5	
BWR113RBE6	3/4 X 6	5	

## IPT CLOSE NIPPLE 112A

BRASS FITTING

Line: 551-89



PART NO.	SIZE	QTY/BX	LIST PRICE
BWT112AA	1/8	10	
BWT112AB	1/4	10	
BWT112AC	3/8	10	
BWT112AD	1/2	10	
BWT112AE	3/4	10	

## IPT 90° STREET ELBOW 116A

BRASS FITTING

Line: 551-90

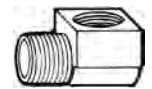

PART NO.	SIZE	QTY/BX	LIST PRICE
BWV116AA	1/8	10	
BWV116AB	1/4	10	
BWV116AC	3/8	10	
BWV116AD	1/2	5	
BWV116AE	3/4	5	

## IPT ADAPTER 120A

BRASS FITTING

Line: 551-91

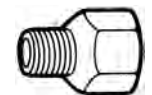

PART NO.	SIZE	QTY/BX	LIST PRICE
BWW120AAA	1/8 X 1/8	10	
BWW120ABA	1/4 X 1/8	10	
BWW120ABB	1/4 X 1/4	10	
BWW120ACA	3/8 X 1/8	10	
BWW120ACB	3/8 X 1/4	10	
BWW120ACC	3/8 X 3/8	10	
BWW120ADB	1/2 X 1/4	10	
BWW120ADC	1/2 X 3/8	10	
BWW120ADD	1/2 X 1/2	10	
BWW120AED	3/4 X 1/2	5	

### IPT HEX PLUG 121A

BRASS FITTING

Line: 551-92

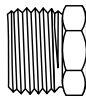

PART NO.	SIZE	QTY/BX	LIST PRICE
BWX121AA	1/8	10	
BWX121AB	1/4	10	
BWX121AC	3/8	10	
BWX121AD	1/2	10	
BWX121AE	3/4	10	
BWX121AF	1	5	

### IPT HEX NIPPLE 122A

BRASS FITTING

Line: 551-93

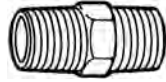

PART NO.	SIZE	QTY/BX	LIST PRICE
BWY122AA	1/8	10	
BWY122AB	1/4	10	
BWY122AC	3/8	10	
BWY122AD	1/2	10	
BWY122AE	3/4	5	

### IPT REDUCING HEX NIPPLE 123A

BRASS FITTING

Line: 551-94



PART NO.	SIZE	QTY/BX	LIST PRICE
BWZ123ABA	1/4 X 1/8	10	
BWZ123ACA	3/8 X 1/8	10	
BWZ123ACB	3/8 X 1/4	10	
BWZ123ADB	1/2 X 1/4	10	
BWZ123ADC	1/2 X 3/8	10	
BWZ123AED	3/4 X 1/2	10	

### IPT 45° STREET ELBOW 124A

BRASS FITTING

Line: 551-95

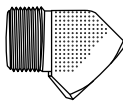

PART NO.	SIZE	QTY/BX	LIST PRICE
BXA124AA	1/8	10	
BXA124AB	1/4	10	
BXA124AC	3/8	10	
BXA124AD	1/2	10	
BXA124AE	3/4	5	

### IPT REDUCING COUPLING 119A

BRASS FITTING

Line: 551-96

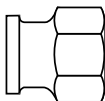

PART NO.	SIZE	QTY/BX	LIST PRICE
BXD119ABA	1/4 X 1/8	10	
BXD119ACA	3/8 X 1/8	10	
BXD119ACB	3/8 X 1/4	10	
BXD119ADA	1/2 X 1/8	5	
BXD119ADB	1/2 X 1/4	10	
BXD119ADC	1/2 X 3/8	10	
BXD119AED	3/4 X 1/2	5	

### IPT HEX COUNTERSUNK PLUG 109CS

BRASS FITTING

Line: 551-97



PART NO.	SIZE	QTY/BX	LIST PRICE
BXE109CSA	1/8	10	
BXE109CSB	1/4	10	
BXE109CSC	3/8	10	
BXE109CSD	1/2	10	
BXE109CSE	3/4	10	

### NEEDLE VALVES COMP/FLARE/IPT TYPES

BRASS FITTING

Line: 552-10

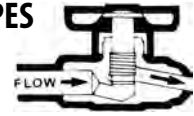

PART NO.	SIZE	QTY/BX	LIST PRICE
BXFA31NV	1/8 FPT/FPT	5	
BXFB48NV	1/8 FPT/MPT	5	
BXFC108MP	1/8 MPT/MPT	5	
BXFA32NV	1/4 FPT/FPT	5	
BXFB49NV	1/4 FPT/MPT	5	
BXFC110MP	1/4 MPT/MPT	5	
BXFD103CC	1/4 X 1/8 SC/MPT ELBOW	5	
BXFD1034CC	1/4 X 1/4 SC/MPT ELBOW	5	
BXFE101CP	1/4 X 1/8 SC/MPT	5	
BXFE101CP4	1/4 X 1/4 SC/MPT	5	
BXFF106CC	1/4 SC/SC	5	
BXFG103SAE	1/4 X 1/8 SF/MPT ELB	5	
BXFH104SAE	1/4 X 1/8 SF/MPT	5	
BXFH105SAE	1/4 X 1/4 SF/MPT	5	
BXFJ110SAE	1/4 X 1/4 SF/SF	5	
BXFD203CC	5/16 X 1/8 SC/MPT ELB	5	
BXFE102CP	5/16 X 1/8 SC/MPT	5	
BXFF107CC	5/16 SC/SC	5	
BXFG203SAE	5/16 X 1/8 SF/MPT ELB	5	
BXFG204SAE	5/16 X 1/4 SF/MPT ELB	5	
BXFH106SAE	5/16 X 1/8 SF/MPT	5	
BXFD303ACC	3/8 X 1/8 SC/MPT ELB	5	
BXFD303CC	3/8 X 1/4 SC/MPT ELB	5	
BXFE143CP	3/8 X 1/4 SC/MPT	5	
BXFF113CC	3/8 SC/SC	5	
BXFG303SAE	3/8 X 1/4 SF/MPT ELB	5	
BXFH108SAE	3/8 X 1/4 SF/MPT	5	
BXFJ115SAE	3/8 X 3/8 SF/SF	5	

## GROUND PLUG VALVES COMP/FLARE/IPT

Line: 552-11

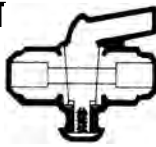

PART NO.	SIZE	QTY/BX	LIST PRICE
BXGC76PC	1/8 MPT/MPT	5	
BXGD31PC	1/8 FPT/FPT	5	
BXGE48PC	1/8 FPT/MPT	5	
BXGA28SAE	1/4 SF/SF	5	
BXGC77PC	1/4 MPT/MPT	5	
BXGD32PC	1/4 FPT/FPT	5	
BXGE49PC	1/4 FPT/MPT	5	
BXGG227CC	1/4 X 1/4 SC/MPT	5	
BXGG27CC	1/4 X 1/8 SC/MPT	5	
BXGH28CC	1/4 SC/SC	5	
BXGJ227SAE	1/4 X 1/4 SF/MPT	5	
BXGJ27SAE	1/4 X 1/8 SF/MPT	5	
BXGA30SAE	5/16 SF/SF	5	
BXGG229CC	5/16 X 1/4 SC/MPT	5	
BXGG29CC	5/16 X 1/8 SC/MPT	5	
BXGH30CC	5/16 SC/SC	5	
BXGJ229SAE	5/16 X 1/4 SF/MPT	5	
BXGJ29SAE	5/16 X 1/8 SF/MPT	5	
BXGA58SAE	3/8 SF/SF	5	
BXGB161SAE	3/8 X 1/2 SF/FPT	5	
BXGB163SAE	3/8 X 3/8 SF/FPT	5	
BXGB165SAE	3/8 X 3/4 SF/FPT	5	
BXGC78PC	3/8 MPT/MPT	5	
BXGD40PC	3/8 FPT/FPT	5	
BXGE50PC	3/8 FPT/MPT	5	
BXGF159SAE	3/8 FE/ML SAE FLR	5	
BXGG557CC	3/8 X 3/8 SC/MPT	5	
BXGG57CC	3/8 X 1/4 SC/MPT	5	
BXGH58CC	3/8 SC/SC	5	
BXGJ557SAE	3/8 X 3/8 SF/MPT	5	
BXGJ57SAE	3/8 X 1/4 SF/MPT	5	
BXGA68SAE	1/2 SF/SF	5	
BXGB164SAE	1/2 X 1/2 SF/FPT	5	
BXGB166SAE	1/2 X 3/4 SF/FPT	5	
BXGD80PC	1/2 FPT/FPT	5	
BXGG67CC	1/2 X 3/8 SC/MPT	5	
BXGG77CC	1/2 X 1/2 SC/MPT	5	
BXGH68CC	1/2 SC/SC	5	
BXGJ67SAE	1/2 X 3/8 SF/MPT	5	
BXGJ77SAE	1/2 X 1/2 SF/MPT	5	
BXGB167SAE	5/8 X 3/4 SF/FPT	5	
BXGD120PC	3/4 FPT/FPT	5	

## EXT & INT DRAIN COCKS

Line: 552-12



PART NO.	SIZE	QTY/BX	LIST PRICE
BXHA200D	1/8 MPT NEEDLE COCK	5	
BXHC300D	1/8 MPT INT SEAT HVY DUTY	5	
BXHC320D	1/8 MPT EXT SEAT DRAIN	5	
BXHD37D	1/8MPT T-HANDLE DRAIN	5	
BXHE41D	1/8 MPT LEVER DRAIN	5	
BXHA201D	1/4 MPT NEEDLE COCK	5	
BXHB201DH	1/4 MPT/90° DRAIN BIB	5	
BXHC321D	1/4 MPT EXT SEAT DRAIN	5	
BXHD38D	1/4MPT T-HANDLE DRAIN	5	
BXHE42D	1/4 MPT LEVER DRAIN	5	
BXHF104HVS	1/4 SC SADDLE VALVE	1	
BXHF104HVST	1/4SC SADL VLV SELF TAP	1	
BXHF204HVB	5/16SC SADDLE VALVE	1	
BXHA202D	3/8 MPT NEEDLE COCK	5	
BXHC322D	3/8 MPT EXT SEAT DRAIN	5	
BXHE43D	3/8 MPT LEVER DRAIN	5	
BXHE44D	1/2 MPT LEVER DRAIN	5	

### ACRONYM KEY:

MPT	MALE PIPE THREAD
FPT	FEMALE PIPE THREAD
SC	COMPRESSION
SF	SAE FLARE

# SECTION 10 PRODUCT INDEX

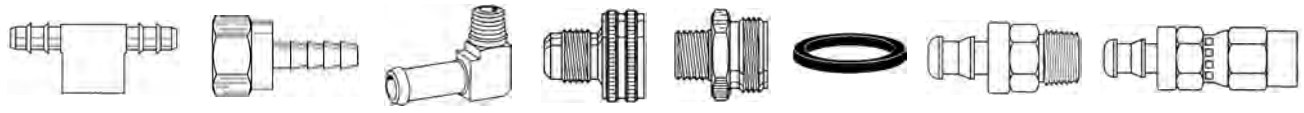

## LOW PRESSURE HOSE FITTINGS

Line Description	Alpha	Line#	Page#
MINI BARB FITTINGS UNIONS - BRASS	<b>SYA</b>	<b>560-00</b>	10-14
MINI BARB FITTINGS UNION TEE - BRASS	<b>SZA</b>	<b>562-00</b>	10-14
MINI BARB FITTINGS UNION ELBOW - BRASS	<b>TAA</b>	<b>563-00</b>	10-14
MINI BARB FITTINGS FEMALE CONNECTOR - BRASS	<b>TBA</b>	<b>564-00</b>	10-14
MINI BARB FITTINGS MALE CONNECTOR - BRASS	<b>TCA</b>	<b>565-00</b>	10-14
MINI BARB FITTINGS MALE ELBOW - BRASS	<b>TDA</b>	<b>566-00</b>	10-14
MINI BARB FITTINGS FEMALE ELBOW - BRASS	<b>TEA</b>	<b>567-00</b>	10-14
MINI BARB FITTINGS MALE RUN TEE - BRASS	<b>TFA</b>	<b>568-00</b>	10-14
MINI BARB FITTINGS MALE BRANCH TEE - BRASS	<b>TGA</b>	<b>569-00</b>	10-14
MINI BARB FITTINGS FEMALE BRANCH TEE - BRASS	<b>TJA</b>	<b>570-00</b>	10-14
LOW PRESSURE PUSH-ON MALE PIPE - BRASS - PARKER/DANA	<b>UAA</b>	<b>571-00</b>	10-15
LOW PRESSURE PUSH-ON MALE SAE FLARE - BRASS - PARKER/DANA	<b>UBA</b>	<b>572-00</b>	10-15
LOW PRESSURE PUSH-ON SAE FEMALE SWIVEL- BRASS - PARKER/DANA	<b>UCA</b>	<b>573-00</b>	10-15
LOW PRESSURE PUSH-ON JIC FEMALE SWIVEL- BRASS - PARKER/DANA	<b>UDA</b>	<b>574-00</b>	10-15
LOW PRESSURE PUSH-ON INV FLARE FEMALE - BRASS - PARKER/DANA	<b>UEA</b>	<b>575-00</b>	10-15
LOW PRES PUSH-ON INV FLARE MALE SWIVL - BRASS - PARKER/DANA	<b>UFA</b>	<b>576-00</b>	10-15
LOW PRESSURE PUSH-ON MALE PIPE ELBOW - BRASS - PARKER/DANA	<b>UGA</b>	<b>577-00</b>	10-15
LOW PRESSURE PUSH-ON BARB TO TUBE - BRASS - PARKER/DANA	<b>UHA</b>	<b>578-00</b>	10-16
LOW PRESSURE PUSH-ON HOSE MENDER - PARKER/DANA	<b>UJA</b>	<b>579-00</b>	10-16
LOW PRESSURE PUSH-ON FEMALE PIPE SWIVEL- BRASS- PARKER/DANA	<b>JLS</b>	<b>579-01</b>	10-16
LOW PRESSURE PUSH-ON MALE PIPE SWIVEL- STEEL- PARKER/DANA	<b>ASN</b>	<b>579-02</b>	10-16
DANA HO57 HOSE FITTING BARB X MALE PIPE - DANA	<b>UKA</b>	<b>580-00</b>	10-16
DANA HO57 HOSE FITTING BARB X 90° MALE PIPE - DANA	<b>ULA</b>	<b>581-00</b>	10-16
DANA HO57 HOSE FITTING BARB X INVERTED FL MALE ELBOW - DANA	<b>UMA</b>	<b>582-00</b>	10-16
DANA HO57 HOSE FITTING BARB X INVERTED FL MALE - DANA	<b>URA</b>	<b>583-00</b>	10-16
HOSE BARB X MALE PIPE CONNECTOR - BRASS	<b>BLB</b>	<b>584-00</b>	10-17
HOSE BARB X FEMALE PIPE CONNECTOR - BRASS	<b>BMB</b>	<b>585-00</b>	10-17
HOSE BARB X 90° MALE PIPE ELBOW - BRASS	<b>BNB</b>	<b>586-00</b>	10-17
HOSE BARB X 45° MALE PIPE ELBOW - BRASS	<b>BPB</b>	<b>587-00</b>	10-18
HOSE BARB X SAE & JIC MALE FLARE - BRASS	<b>BMP</b>	<b>588-02</b>	10-18
HOSE BARB X SAE FEMALE SWIVEL - BRASS	<b>BSB</b>	<b>589-00</b>	10-18
HOSE BARB X FEMALE BALL SEAT SWIVEL - BRASS	<b>BTB</b>	<b>590-00</b>	10-18
HOSE BARB X HOSE MENDER - BRASS - FOR H105 HOSE	<b>BUB</b>	<b>591-00</b>	10-18
HOSE BARB X CLAMPING FURRELS - BRASS	<b>BVB</b>	<b>592-00</b>	10-18
GARDEN HOSE FITTING BARB X MALE GARDEN HOSE THREAD - BRASS	<b>JCH</b>	<b>592-01</b>	10-18
GARDEN HOSE FITTING MALE (GHT) TO MALE PIPE - BRASS	<b>AEK</b>	<b>592-03</b>	10-18
GARDEN HOSE FITTING MALE (GHT) TO FEMALE PIPE - BRASS	<b>AEL</b>	<b>592-04</b>	10-19
GARDEN HOSE FITTING FEMALE (GHT) TO MALE PIPE - BRASS	<b>AEM</b>	<b>592-05</b>	10-19
GARDEN HOSE FITTING SWIVEL FEMALE (GHT) TO MALE PIPE - BRASS	<b>AEN</b>	<b>592-06</b>	10-19

(CONTINUED...)

# SECTION 10 PRODUCT INDEX

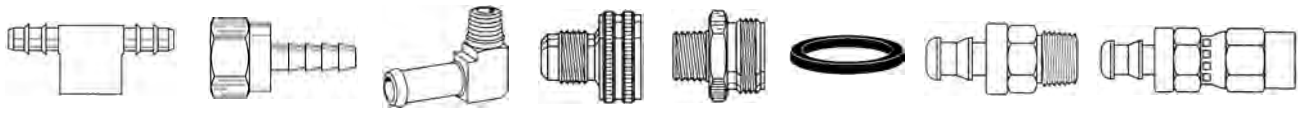

## LOW PRESSURE HOSE FITTINGS (continued)

Line Description	Alpha	Line#	Page#
GARDEN HOSE FITTING SWIVEL FEMALE (GHT) TO HOSE BARB - BRASS	<b>AEP</b>	<b>592-07</b>	10-19
GARDEN HOSE FITTING FEMALE (GHT) NUT - BRASS	<b>AER</b>	<b>592-08</b>	10-19
GARDEN HOSE FITTING (GHT) CAP - BRASS	<b>AEV</b>	<b>592-10</b>	10-19
GARDEN HOSE FITT FEMALE (GHT) TO FEMALE PIPE THREAD - BRASS	<b>AEW</b>	<b>592-11</b>	10-19
GARDEN HOSE FITT SWIVEL (GHT) TO FEMALE PIPE THREAD - BRASS	<b>AEX</b>	<b>592-12</b>	10-19
GARDEN HOSE FITTING FEMALE (GHT) SWIVEL NUT UNION - BRASS	<b>AEY</b>	<b>592-13</b>	10-19
GARDEN HOSE FITT FEMALE SWIVEL (GHT) MALE SAE FLARE - BRASS	<b>AEZ</b>	<b>592-14</b>	10-19
GARDEN HOSE FITT (GHT) RUBBER WASHERS	<b>AFB</b>	<b>592-15</b>	10-19

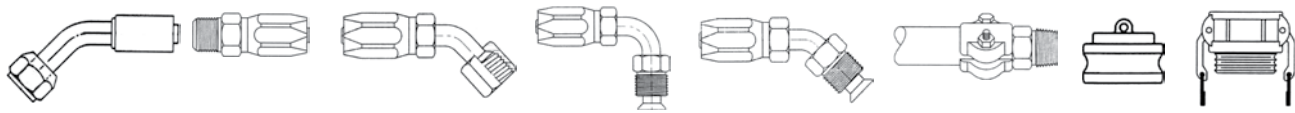

## REUSABLE HYDRAULIC FITTINGS

Line Description	Alpha	Line#	Page#
MED PRES REUSEABLE HYD HOSE FITT MLE PIPE 1-WIRE PARKER/DANA	<b>UWA</b>	<b>603-00</b>	10-19
MED PRES REUSEABLE HYD HOSE FITT MLE SAE 1-WIRE PARKER/DANA	<b>UXA</b>	<b>604-00</b>	10-19
MED PRES REUSE HYD HOSE FIT FEM SAE SWIVL 1-WIRE PARKER/DANA	<b>UYA</b>	<b>605-00</b>	10-20
MED PRES REUSE HYD HOSE FITT MLE 37° JIC 1-WIRE-PARKER/DANA	<b>UZA</b>	<b>606-00</b>	10-20
MED PRES REUSE HYD HOSE FIT JIC FEM SWIVL 1-WIRE-PARKER/DANA	<b>VAA</b>	<b>607-00</b>	10-20
MED PRES REUSE HYD HOSE FIT FE JIC 90° LNG 1-WIRE-PARKER/DANA	<b>VBA</b>	<b>608-00</b>	10-20
MED PRES REUSE HYD HOSE FIT FE SAE 90° LNG 1-WIRE-PARKER/DANA	<b>VCA</b>	<b>609-00</b>	10-20
MED PRES REUSE 1-WIRE HYD HOSE FITT 90° FEM JIC - PARKER/DANA	<b>VDA</b>	<b>610-00</b>	10-20
MED PRES REUSE 1-WIRE HYD HOSE FITT 45° FEM JIC - PARKER/DANA	<b>VFA</b>	<b>612-00</b>	10-20
MED PRES REUSE 1-WIRE HYD HOSE FITT INV MALE NUT-PARKER/DANA	<b>VJA</b>	<b>615-00</b>	10-20
MED PRES REUSE 1-WIRE HYD HSE FIT INV 90° MLE NUT-PARKER/DANA	<b>VKA</b>	<b>616-00</b>	10-20
MED PRES REUSE 1-WIRE HYD HSE FIT INV 45° MLE NUT-PARKER/DANA	<b>JMS</b>	<b>616-01</b>	10-21
MED PRES REUSE 1-WIRE HYD HOSE FITT HOSE X TUBE - PARKER/DANA	<b>VPA</b>	<b>619-00</b>	10-21
MED PRES REUSE 1-WIRE HYD HOSE FIT AIR BRAKE END-PARKER/DANA	<b>VUA</b>	<b>623-00</b>	10-21
HI PRES REUSE 2-WIRE HYD HOSE FITT MALE PIPE - PARKER/DANA	<b>VVA</b>	<b>624-00</b>	10-21
HI PRES REUSE 2-WIRE HYD HOSE FIT FEM PIPE SWVL - PARKER/DANA	<b>VWA</b>	<b>624-01</b>	10-21
HI PRES REUSE 2-WIRE HYD HOSE FITT MALE JIC - PARKER/DANA	<b>VXA</b>	<b>625-00</b>	10-21
HI PRES REUSE 2-WIRE HYD HOSE FITT JIC FE SWVL - PARKER/DANA	<b>VYA</b>	<b>626-00</b>	10-21
HI PRES REUSE 2-WIRE HYD HOSE FITT SAE FE SWVL - PARKER/DANA	<b>VZA</b>	<b>627-00</b>	10-21
HI PRES REUSE 2-WIRE HYD HSE FIT JIC 90° FEM LONG-PRKER/DANA	<b>WAA</b>	<b>628-00</b>	10-21
HI PRES REUSE 2-WIRE HYD HSE FIT JIC 90° FEM REG-PARKER/DANA	<b>WBA</b>	<b>629-00</b>	10-22
HI PRES REUSE 2-WIRE HYD HSE FITT JIC 45° FEM -PARKER/DANA	<b>JNS</b>	<b>629-01</b>	10-22
HI PRES REUSE 2-WIRE HYD HSE FIT O-RING BOSS THD-PARKER/DANA	<b>JPS</b>	<b>629-02</b>	10-22
HI-PRES CLAMP TYPE ASSEMBLY MALE PIPE THD - PARKER/DANA	<b>WDA</b>	<b>630-00</b>	10-22
HI-PRES CLAMP TYPE HOSE END MALE PIPE THD - PARKER/DANA	<b>JVS</b>	<b>630-02</b>	10-22
HI-PRES CLAMP COLLAR FOR K SERIES	<b>AXA</b>	<b>630-03</b>	10-22

(CONTINUED...)



# SECTION 10 PRODUCT INDEX

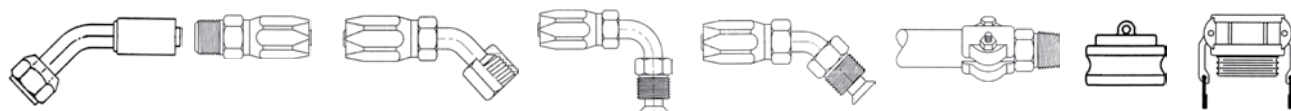

## REUSABLE HYDRAULIC FITTINGS (continued)

Line Description	Alpha	Line#	Page#
STEEL BARB X MALE PIPE THREAD PLATED	<b>AXM</b>	<b>630-10</b>	10-22
STEEL BARB UNION COUPLING PLATED	<b>AXN</b>	<b>630-11</b>	10-22
CAM/LOK COUPLER MALE PIPE X FEMALE PIPE - ALUMINUM	<b>AYJ</b>	<b>630-20</b>	10-23
CAM/LOK COUPLER FEMALE PIPE X MALE PIPE - ALUMINUM	<b>AYK</b>	<b>630-21</b>	10-23
CAM/LOK COUPLER FEMALE X BARB SHANK - ALUMINUM	<b>AYL</b>	<b>630-22</b>	10-23
CAM/LOK COUPLER FEMALE X FEMALE PIPE - ALUMINUM	<b>AYM</b>	<b>630-23</b>	10-23
CAM/LOK COUPLER MALE X BARB SHANK - ALUMINUM	<b>AYN</b>	<b>630-24</b>	10-23
CAM/LOK COUPLER MALE X MALE PIPE - ALUMINUM	<b>AYP</b>	<b>630-25</b>	10-23
CAM/LOK GROOVE MALE PLUG - ALUMINUM	<b>BAL</b>	<b>630-26</b>	10-24
CAM/LOK GROOVE FEMALE CAP - ALUMINUM	<b>BAM</b>	<b>630-27</b>	10-24
CAM/LOK GROOVE MALE UNION - ALUMINUM	<b>BHV</b>	<b>630-28</b>	10-24
CAM/LOK FITTINGS HANDLE/GASKETS	<b>BHW</b>	<b>630-29</b>	10-24



## STEEL ADAPTERS

Line Description	Alpha	Line#	Page#
JIC ADAPT FITTINGS - 3 PIECE NUT - STEEL	<b>WFA</b>	<b>647-00</b>	10-24
JIC ADAPT FITTINGS - 2 PIECE NUT - STEEL	<b>WGA</b>	<b>648-00</b>	10-25
JIC ADAPT FITTINGS - SLEEVE - STEEL	<b>WHA</b>	<b>649-00</b>	10-25
JIC ADAPT FITTINGS - CAP - STEEL	<b>WJA</b>	<b>650-00</b>	10-25
JIC ADAPT FITTINGS - PLUG - STEEL	<b>WLA</b>	<b>652-00</b>	10-25
JIC ADAPT FITTINGS - HEX UNION - STEEL	<b>WMA</b>	<b>653-00</b>	10-25
JIC ADAPT FITTINGS - LARGE HEX UNION - STEEL	<b>WNA</b>	<b>654-00</b>	10-26
JIC ADAPT FITTINGS - BULKHEAD UNION - STEEL	<b>WPA</b>	<b>655-00</b>	10-26
JIC ADAPT FITTINGS - 45° BULKHEAD UNION - STEEL	<b>WRA</b>	<b>656-00</b>	10-26
JIC ADAPT FITTINGS - 90° UNION ELBOW - STEEL	<b>WSA</b>	<b>657-00</b>	10-26
JIC ADAPT FITTINGS - BULKHEAD UNION ELBOW - STEEL	<b>WTA</b>	<b>657-05</b>	10-26
JIC ADAPT FITTINGS - UNION TEE ELBOW - STEEL	<b>WUA</b>	<b>658-00</b>	10-26
JIC ADAPT FITTINGS - BULKHEAD BRANCH TEE ELBOW - STEEL	<b>WVA</b>	<b>659-00</b>	10-27
JIC ADAPT FITTINGS - BULKHEAD RUN TEE - STEEL	<b>WWA</b>	<b>660-00</b>	10-27
JIC ADAPT FITTINGS - MALE/FEMALE SWIVEL REDUCER - STEEL	<b>AXB</b>	<b>660-02</b>	10-27
JIC ADAPT FITTINGS - MALE/FEMALE SWIVEL 45° ELBOW - STEEL	<b>WAY</b>	<b>661-00</b>	10-27
JIC ADAPT FITTINGS - MALE/FEMALE SWIVEL 90° ELBOW - STEEL	<b>WZA</b>	<b>662-00</b>	10-27
JIC ADAPT FITTINGS - SWIVEL NUT MALE RUN TEE - STEEL	<b>XAA</b>	<b>663-00</b>	10-27
JIC ADAPT FITTINGS - SWIVEL NUT MALE BRANCH TEE - STEEL	<b>XBA</b>	<b>664-00</b>	10-28
JIC ADAPT FITTINGS - BULKHEAD CLAMPING NUT - STEEL	<b>XCA</b>	<b>665-00</b>	10-28
JIC ADAPT FITTINGS - MALE CONNECTOR - STEEL	<b>XDA</b>	<b>666-00</b>	10-28

(CONTINUED...)

# SECTION 10 PRODUCT INDEX



## STEEL ADAPTERS (continued)

Line Description	Alpha	Line#	Page#
JIC ADAPT FITTINGS - FEMALE CONNECTOR - STEEL	<b>XEA</b>	<b>667-00</b>	10-29
JIC ADAPT FITTINGS - 45° MALE ELBOW - STEEL	<b>XFA</b>	<b>668-00</b>	10-29
JIC ADAPT FITTINGS - 90° MALE ELBOW - STEEL	<b>XGA</b>	<b>669-00</b>	10-29
JIC ADAPT FITTINGS - 90° LONG MALE ELBOW - STEEL	<b>XHA</b>	<b>670-00</b>	10-29
JIC ADAPT FITTINGS - 90° X-LONG MALE ELBOW - STEEL	<b>XJA</b>	<b>671-00</b>	10-30
JIC ADAPT FITTINGS - 90° FEMALE ELBOW - STEEL	<b>XKA</b>	<b>672-00</b>	10-30
JIC ADAPT FITTINGS - MALE BRANCH TEE - STEEL	<b>XMA</b>	<b>673-00</b>	10-30
JIC ADAPT FITTINGS - FEMALE BRANCH TEE - STEEL	<b>XNA</b>	<b>674-00</b>	10-30
JIC ADAPT FITTINGS - MALE RUN TEE - STEEL	<b>XPA</b>	<b>675-00</b>	10-31
JIC ADAPT FITTINGS - FEMALE RUN TEE - STEEL	<b>XRA</b>	<b>676-00</b>	10-31
JIC ADAPT FITTINGS - FEMALE BULKHEAD CONNECTOR - STEEL	<b>JCU</b>	<b>676-01</b>	10-31
JIC ADAPT FITTINGS - O-RING MALE CONNECTOR - STEEL	<b>XSA</b>	<b>677-00</b>	10-31
JIC ADAPT FITTINGS - O-RING LONG MALE CONNECTOR - STEEL	<b>XTA</b>	<b>678-00</b>	10-31
JIC ADAPT FITTINGS - O-RING 45° MALE ELBOW - STEEL	<b>XUA</b>	<b>679-00</b>	10-32
JIC ADAPT FITTINGS - O-RING 90° MALE ELBOW - STEEL	<b>XVA</b>	<b>680-00</b>	10-32
JIC ADAPT FITTINGS - O-RING MALE BRANCH TEE- STEEL	<b>XWA</b>	<b>681-00</b>	10-32
JIC ADAPT FITTINGS - O-RING MALE RUN TEE- STEEL	<b>XXA</b>	<b>682-00</b>	10-32
JIC ADAPT FITTINGS - O-RING INVERTED MALE - STEEL	<b>XYA</b>	<b>683-00</b>	10-33
SWIV ADAPTER STRA FPT X MPT CONNECTOR - STEEL	<b>YYA</b>	<b>684-00</b>	10-33
SWIV ADAPTER STRA FPT X MPT 45° ELBOW - STEEL	<b>ZYA</b>	<b>685-00</b>	10-33
SWIV ADAPTER STRA FPT X MPT 90° ELBOW - STEEL	<b>ZAA</b>	<b>686-00</b>	10-33
SWIV ADAPTER STRA FPT X FPT CONNECTOR - STEEL	<b>ZBA</b>	<b>687-00</b>	10-33
SWIV ADAPTER STRA FPT X FPT 45° ELBOW - STEEL	<b>ZCA</b>	<b>688-00</b>	10-34
SWIV ADAPTER STRA FPT X FPT 90° ELBOW - STEEL	<b>ZDA</b>	<b>689-00</b>	10-34
SWIV ADAPTER MALE O-RING X FPT CONNECTOR - STEEL	<b>ZEA</b>	<b>690-00</b>	10-34
SWIV ADAPTER MALE O-RING X FPT 90° ELBOW - STEEL	<b>ZGA</b>	<b>691-00</b>	10-34
SWIV ADAPTER MALE O-RING X FPT 45° ELBOW - STEEL	<b>JWT</b>	<b>691-01</b>	10-35
SWIV ADAPTER MALE X FEMALE SAE 90° ELBOW - STEEL	<b>ZHA</b>	<b>692-00</b>	10-35
SWIV ADAPTER MALE X FEMALE SAE 45° ELBOW - STEEL	<b>ZJA</b>	<b>693-00</b>	10-35
FEMALE JIC SWIVL JIC X MALE PIPE CONNECTOR - STEEL	<b>JXT</b>	<b>693-01</b>	10-35
FEMALE JIC SWIVL X MALE O-RING CONNECTOR - STEEL	<b>AWZ</b>	<b>693-02</b>	10-35
HI-PRES PIPE FITTINGS - HEX PLUG - STEEL	<b>XZA</b>	<b>694-00</b>	10-35
HI-PRES PIPE FITTINGS - HEX SOCKET PLUG STEEL	<b>YAA</b>	<b>695-00</b>	10-36
HI-PRES PIPE FITTINGS - COUPLINGS - STEEL	<b>YCA</b>	<b>696-00</b>	10-36
HI-PRES PIPE FITTINGS - HEX NIPPLE - STEEL	<b>YDA</b>	<b>697-00</b>	10-36
HI-PRES PIPE FITTINGS - 45° STREET ELBOW - STEEL	<b>YEA</b>	<b>698-00</b>	10-36
HI-PRES PIPE FITTINGS - 90° STREET ELBOW - STEEL	<b>YFA</b>	<b>699-00</b>	10-36
HI-PRES PIPE FITTINGS - 90° FEMALE ELBOW - STEEL	<b>YGA</b>	<b>700-00</b>	10-36
HI-PRES PIPE FITTINGS - 45° FEMALE ELBOW - STEEL	<b>YHA</b>	<b>701-00</b>	10-36

(CONTINUED...)

# SECTION 10 PRODUCT INDEX



## STEEL ADAPTERS (continued)

Line Description	Alpha	Line#	Page#
HI-PRES PIPE FITTINGS - FEMALE TEE - STEEL	YJA	702-00	10-37
HI-PRES PIPE FITTINGS - SEAL PIPE LOKNUT - STEEL	YLA	703-00	10-37
HI-PRES PIPE FITTINGS - HEX BUSHINGS - STEEL	YMA	704-00	10-37
HI-PRES PIPE FITTINGS - 90° MALE PIPE THREAD ELBOW - STEEL	JYT	704-01	10-37
HI-PRES PIPE FITTINGS - MALE PIPE THREAD BRANCH TEE - STEEL	JZT	704-02	10-37
HI-PRES PIPE FITTINGS - MALE PIPE THREAD RUN TEE - STEEL	JAU	704-03	10-37
HI-PRES PIPE FITTINGS - MALE CROSS TEE - STEEL	JBU	704-04	10-37
METRIC CONV ADAPT - MALE BSPT X FPT - STEEL	CEE	704-50	10-38
METRIC CONV ADAPT - MALE BSPP X O-RING - STEEL	CEF	704-51	10-38
METRIC CONV ADAPT - MALE BSPP X FEM/NPT - STEEL	CEG	704-52	10-38
METRIC CONV ADAPT - METRIC THREAD X FEM/NPT - STEEL	CEH	704-53	10-38
METRIC CONV ADAPT - BSPT X HEX NIPPLE - STEEL	CEJ	704-75	10-38
METRIC CONV ADAPT - BSPT X COUPLING - STEEL	CEK	704-76	10-38
BOSS O-RING FITTING REDUCE/EXPANDING ADAPT - STEEL	ARR	704-99	10-38
BOSS O-RING FITTING MALE O-RING X FEMALE PIPE - STEEL	YNA	705-00	10-39
BOSS O-RING FITTING FLUSH SOCKET PLUG - STEEL	BDF	705-01	10-39
BOSS O-RING FITTING HEX PLUG - STEEL	ARM	705-02	10-39
BOSS O-RING FITTING UNION - STEEL	AXD	705-03	10-39
MALE METRIC X FEM INCH O-RING THD CONVERSION ADAPT - STEEL	AXE	705-04	10-39
ADAPTER - PIPE THREAD EXPANDER - STEEL	AXF	705-05	10-40
ADAPTER - FEM O-RING X MALE PIPE THREAD - STEEL	AXG	705-06	10-40
ADAPTER - MALE O-RING X MALE PIPE THREAD - STEEL	AXH	705-07	10-40
ADAPTER - MALE O-RING X MALE 90° ELBOW - STEEL	AXJ	705-08	10-40
ADAPTER - FEMALE JIC SWIVEL X MALE 90° ELBOW - STEEL	AXK	705-09	10-40
ADAPTER - MALE PIPE SWIVEL X MALE 90° ELBOW - STEEL	AXL	705-10	10-41
ADAPTER - MALE O-RING X FEMALE 90° ELBOW - STEEL	AYY	705-11	10-41
ADAPTER - MALE O-RING X FEMALE JIC SWIVEL 90° ELBOW - STEEL	AZD	705-13	10-41
ADAPTER - MALE JIC X FEMALE JIC SWIVEL CONNECTOR - STEEL	AZL	705-20	10-41
ADAPTER - FEMALE JICSWIVEL X FEMALE PIPECONNECTOR - STEEL	AZM	705-21	10-41
ADAPTER - FEM PIPE X STRA MPT O-RING 90° ELBOW - STEEL	YPA	706-00	10-41
ADAPTER - LONG FPT X STRA MPT O-RING 90° ELBOW - STEEL	YRA	707-00	10-41
ADAPTER - MALE SEAL-LOK X MALE O-RING 90° ELBOW - STEEL	AZY	707-20	10-42
ADAPTER - MALE SEAL-LOK X MALE O-RING STRAIGHT - STEEL	AZZ	707-21	10-42
ADAPTER - MALE SEAL-LOK X MALE O-RING 45° ELBOW - STEEL	BAB	707-22	10-42
ADAPTER - MALE SEAL-LOK X MALE PIPE 90° ELBOW - STEEL	BAE	707-23	10-43
ADAPTER - MALE SEAL-LOK X MALE PIPE STRAIGHT - STEEL	BAF	707-24	10-43
ADAPTER - FEMALE SWVL SEAL-LOK X MALE O-RING 90° ELBOW - STEEL	BAG	707-25	10-43
ADAPTER - FEMALE SEAL-LOK X MALE SEAL-LOK 90° ELBOW - STEEL	BAH	707-26	10-43
ADAPTER - MALE SEAL-LOK UNION ELBOW 90° ELBOW - STEEL	BAJ	707-27	10-43

(CONTINUED...)

# SECTION 10 PRODUCT INDEX



## STEEL ADAPTERS (continued)

Line Description	Alpha	Line#	Page#
ADAPTER - MALE SEAL-LOK UNION STRAIGHT - STEEL	<b>BAK</b>	<b>707-28</b>	10-44
ADAPTER - MALE SEAL-LOK UNION TEE - STEEL	<b>BAP</b>	<b>707-29</b>	10-44
ADAPTER - MALE SEAL-LOK X MALE JIC STRAIGHT - STEEL	<b>BAT</b>	<b>707-30</b>	10-44
ADAPTER - MALE SEAL-LOK X FEMALE JIC SWIVEL CONN - STEEL	<b>BAY</b>	<b>707-31</b>	10-44
ADAPTER - FEMALE SEAL-LOK SWIVEL X MALE JIC CONN - STEEL	<b>BAD</b>	<b>707-32</b>	10-44
ADAPTER - SEAL-LOK TUBE NUT - STEEL	<b>BBD</b>	<b>707-33</b>	10-44
ADAPTER - FEMALE SEAL-LOK SWIVEL X MALE SEAL-LOK - STEEL	<b>BBE</b>	<b>707-34</b>	10-45
ADAPTER - SEAL-LOK SWIVEL NUT RUN TEE - STEEL	<b>BHK</b>	<b>707-35</b>	10-45
ADAPTER - SEAL-LOK SWIVEL NUT BRANCH TEE - STEEL	<b>BHL</b>	<b>707-36</b>	10-45
ADAPTER - SEAL-LOK O-RING RUN TEE - STEEL	<b>BHM</b>	<b>707-37</b>	10-45
ADAPTER - SEAL-LOK HEX PLUG- STEEL	<b>BHN</b>	<b>707-38</b>	10-45
ADAPTER - SEAL-LOK HEX CAP- STEEL	<b>BHP</b>	<b>707-39</b>	10-45
O-RINGS FOR HI PRESSURE FITTINGS - STEEL	<b>YSA</b>	<b>708-00</b>	10-46
METRIC FITT (L) MALE BSPT X MALE BSPP 30° SEAT STRA -STEEL	<b>BRT</b>	<b>708-10</b>	10-46
METRIC FITT (L) MALE BSPT X MALE BSPP 30° SEAT ELBOW -STEEL	<b>BRV</b>	<b>708-11</b>	10-46
METRIC FITT MALE BSPT X MALE BSPP 30° SEAT STRA -STEEL	<b>BRW</b>	<b>708-12</b>	10-46
METRIC FITT MALE BSPT X MALE BSPP 30° JIS SEAT ELBOW -STEEL	<b>BRX</b>	<b>708-13</b>	10-46
METRIC FITT FEMALE BSPT X MALE BSPP JIS 30° SEAT STRA -STEEL	<b>BRY</b>	<b>708-14</b>	10-46
METRIC FITT MALE BSPT X FEMALE BSPP SWVL JIS 60° STRA -STEEL	<b>BRZ</b>	<b>708-15</b>	10-46
METRIC FITT FEM BSPT X FEMALE BSPP SWVL JIS 24° STRA -STEEL	<b>CDT</b>	<b>708-16</b>	10-47
METRIC FITT MALE BSPP X MALE METRIC 24° STRA (L) -STEEL	<b>CDR</b>	<b>708-17</b>	10-47
METRIC FITT ELECTRIC SEAL BSPP X MM 24° STRA (L) -STEEL	<b>CDV</b>	<b>708-18</b>	10-47
METRIC FITT BSPP X MALE METRIC ELASTIC 24° STRA (S) -STEEL	<b>CDX</b>	<b>708-19</b>	10-47
METRIC FITT JIC SWVL X MALE BSPP STRA -STEEL	<b>CDY</b>	<b>708-20</b>	10-47
METRIC FITT FEM JIC SWVL X MALE METRIC STRA -STEEL	<b>CDZ</b>	<b>708-21</b>	10-47



## TOOLS

Line Description	Alpha	Line#	Page#
SEGMENTED FLARING TOOL	<b>ZKA</b>	<b>723-00</b>	10-47
SINGLE FLARING TOOL	<b>ZKA</b>	<b>724-00</b>	10-47
TUBING BENDING SPRING SET 1/4-1/2 - STEEL	<b>ZKA</b>	<b>726-00</b>	10-48
TUBING BENDING SPRING SET 1/4-5/8 - STEEL	<b>ZKA</b>	<b>727-00</b>	10-48
TUBING BENDER LEVER STYLE	<b>ZKA</b>	<b>728-00</b>	10-48
TUBING BENDING SPRING SINGLE - STEEL	<b>ZKA</b>	<b>729-00</b>	10-48

# SECTION 10 PRODUCT INDEX



## HOSE AND TUBE

Line Description	Alpha	Line#	Page#
TUBING - NYLON 1M P.S.I. NATURAL COLOR	<b>EDB</b>	<b>748-00</b>	10-48
TUBING - NYLON M P.S.I. BLACK COLOR	<b>EEB</b>	<b>748-01</b>	10-48
TUBING - NYLON 2M P.S.I. NATURAL COLOR	<b>EGB</b>	<b>749-00</b>	10-48
TUBING - NYLON 2M P.S.I. BLACK COLOR	<b>EGB</b>	<b>749-01</b>	10-48
TUBING - POLYETHYLENE NATURAL COLOR - BULK ROLL	<b>ANL</b>	<b>749-50</b>	10-48
TUBING - POLYETHYLENE BLACK COLOR - BULK ROLL	<b>ANM</b>	<b>749-51</b>	10-49
TUBING - POLYETHYLENE NATURAL COLOR - SMALL DIA	<b>EHB</b>	<b>750-00</b>	10-49
TUBING - POLYETHYLENE BLACK COLOR - SMALL DIA	<b>EJB</b>	<b>750-01</b>	10-49
TUBING - POLYETHYLENE BLUE COLOR	<b>EPB</b>	<b>750-03</b>	10-49
TUBING - POLYETHYLENE GREEN COLOR	<b>ENB</b>	<b>750-04</b>	10-49
TUBING - POLYETHYLENE ORANGE COLOR	<b>EMB</b>	<b>750-05</b>	10-49
TUBING - POLYETHYLENE RED COLOR	<b>ELB</b>	<b>750-06</b>	10-49
TUBING - POLYETHYLENE YELLOW COLOR	<b>EKB</b>	<b>750-08</b>	10-49
HOSE GENERAL PURPOSE PARFLEX STYLE (AIR/WATER)	<b>EWB</b>	<b>751-00</b>	10-49
TUBING NYLON J844 TRUCK TUBING - BLACK	<b>EXB</b>	<b>752-00</b>	10-49
TUBING NYLON J844 TRUCK TUBING - BLUE	<b>JFU</b>	<b>752-01</b>	10-50
TUBING NYLON J844 TRUCK TUBING - GREEN	<b>FAB</b>	<b>752-02</b>	10-50
TUBING NYLON J844 TRUCK TUBING - ORANGE	<b>EZB</b>	<b>752-03</b>	10-50
TUBING NYLON J844 TRUCK TUBING - WHITE	<b>JGU</b>	<b>752-04</b>	10-50
TUBING NYLON J844 TRUCK TUBING - RED	<b>EYB</b>	<b>752-05</b>	10-50
TUBING NYLON J844 TRUCK TUBING - YELLOW	<b>JHU</b>	<b>752-06</b>	10-50
TUBING POLY VINYL CHLORIDE CLEAR	<b>FEB</b>	<b>753-00</b>	10-50
TUBING PVC FOOD GRADE BRAIDED CLEAR FDA APPRV	<b>AZX</b>	<b>753-02</b>	10-50
HOSE TRUCK EQUIPMENT HEATER HOSE 50'	<b>FFB</b>	<b>754-01</b>	10-50
HOSE H057 LOW PRESSURE HOSE	<b>FGB</b>	<b>756-00</b>	10-51
HOSE WINDSHIELD WIPER VACUME HOSE	<b>BER</b>	<b>756-02</b>	10-51
HOSE #831 LOW PRESSURE PUSH-ON	<b>FJB</b>	<b>758-00</b>	10-51
HOSE H338 AIR BRAKE TRUCK HOSE	<b>FKB</b>	<b>759-00</b>	10-51
HOSE H017 COLOCrimp HYD HOSE FITTINGS - U-SERIES	<b>FLB</b>	<b>760-00</b>	10-51
HOSE - H166 MED PRESSURE 1 SS WIRE BRAID	<b>FPB</b>	<b>763-00</b>	10-51
HOSE - H069 MED PRESSURE 1-WIRE COTTON COVER BRAID	<b>FRB</b>	<b>764-00</b>	10-51
HOSE - H169 MED PRESSURE 1-WIRE COTTON COVER BRAID	<b>JKU</b>	<b>764-01</b>	10-51
HOSE - H366 MED PRESSURE L-P GAS HOSE	<b>FTB</b>	<b>766-00</b>	10-52
HOSE - MED PRESSURE WIRE COVER HYD HOSE - PARKER	<b>AUP</b>	<b>768-03</b>	10-52
HOSE - HI PRESSURE ABRASION RESIST COVER CRIMP - PARKER	<b>BAZ</b>	<b>772-50</b>	10-52
HOSE - #436 HI PRESSURE 100-R2 FUEL HOSE CRIMP - PARKER	<b>BBX</b>	<b>772-51</b>	10-52
HOSE - #341 HI PRESSURE 4-WIRE COMPACT HOSE CRIMP - PARKER	<b>BBY</b>	<b>772-52</b>	10-52
HOSE - #302 HI PRESSURE 2-WIRE HYDRALIC HOSE CRIMP - PARKER (WAS #301)	<b>AGF</b>	<b>773-01</b>	10-52
HOSE - #381 HI PRESSURE 2-WIRE HYDRALIC HOSE CRIMP - PARKER	<b>AGH</b>	<b>773-03</b>	10-52

(CONTINUED...)

# SECTION 10 PRODUCT INDEX



## HOSE AND TUBE (continued)

Line Description	Alpha	Line#	Page#
HOSE - #881 LOW PRESSURE CRIMP TYPE - PARKER SUCTION/RETURN LINES	<b>AGJ</b>	<b>773-04</b>	10-52
HOSE - #510 MEDIUM PRESSURE PARFLEX CRIMP - PARKER	<b>AGL</b>	<b>773-06</b>	10-52
HOSE - #518 HI PRESSURE NON/COND ORANGE PARFLEX - PARKER	<b>AGM</b>	<b>773-07</b>	10-53
HOSE - #520N HI PRESSURE BLACK CRIMP PARFLEX - PARKER	<b>AGN</b>	<b>773-08</b>	10-53
HOSE - #510C HI PRESSURE BLACK TWINLINE PARFLEX - PARKER	<b>BJP</b>	<b>773-11</b>	10-53
HOSE - #919 TEFLON INNER/ST-STL BRAID PARFLEX - PARKER	<b>AGX</b>	<b>773-13</b>	10-53
HOSE - #590 WIRE BRAID HYD HOSE H/P PARFLEX - PARKER	<b>CBM</b>	<b>773-16</b>	10-53
HOSE - #772TC V/HI-PRESS 4-WIRE 100-R12 CRIMP - PARKER	<b>AUY</b>	<b>773-20</b>	10-53
HOSE - #772TC ULTRA HI-PRESS 6-WIRE 100-RI3 CRIMP - PARKER	<b>BXK</b>	<b>773-21</b>	10-53
HOSE - #471ST SUPER TUFF COVER HI PRESSURE CRIMP - PARKER	<b>CBY</b>	<b>773-22</b>	10-53
HOSE - SPRING GUARD FOR HYD/HOSE - PARKER	<b>AJT</b>	<b>774-03</b>	10-53
AIR HOSE ASSEMBLIES W/ 1/4 MPT ENDS	<b>CCG</b>	<b>775-10</b>	10-54
H105 ALL PURPOSE RUBBER AIR HOSE	<b>GFB</b>	<b>776-00</b>	10-54
PVC FLAT WATER DISCHARGE HOSE	<b>AYV</b>	<b>776-03</b>	10-54
COPPER TUBING (SOFT) 50' COILS - AUTOMOTIVE REFRIDGERATION	<b>GGB</b>	<b>777-00</b>	10-54

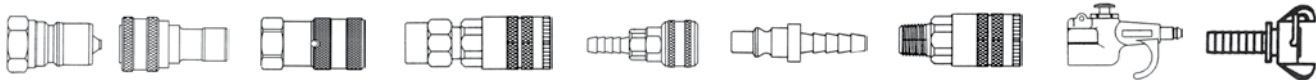

## QUICK COUPLERS, BLOW GUNS - AIR & HYDRAULIC

Line Description	Alpha	Line#	Page#
20 SERIES FEMALE AIR COUPLERS - PARKER	<b>AVC</b>	<b>790-00</b>	10-54
20 SERIES MALE AIR COUPLERS - PARKER	<b>ATC</b>	<b>791-00</b>	10-54
20 SERIES FEMALE NIPPLE - PARKER	<b>AUC</b>	<b>792-00</b>	10-55
20 SERIES MALE NIPPLE - PARKER	<b>AWC</b>	<b>793-00</b>	10-55
20 SERIES HOSE BARB COUPLERS - PARKER	<b>AED</b>	<b>794-00</b>	10-55
20 SERIES HOSE BARB NIPPLES - PARKER	<b>AEE</b>	<b>795-00</b>	10-55
20 SERIES PUSH LOK COUPLERS - PARKER	<b>AEF</b>	<b>796-00</b>	10-55
20 SERIES PUSH LOK NIPPLES - PARKER	<b>AEG</b>	<b>797-00</b>	10-56
20 SERIES HOSE END COUPLERS - PARKER	<b>AEH</b>	<b>798-00</b>	10-56
20 SERIES HOSE END NIPPLES - PARKER	<b>AEJ</b>	<b>799-00</b>	10-56
10 SERIES FEMALE COUPLERS - PARKER	<b>GKD</b>	<b>823-00</b>	10-56
10 SERIES MALE COUPLERS - PARKER	<b>GLD</b>	<b>823-01</b>	10-56
10 SERIES FEMALE NIPPLE - PARKER	<b>GMD</b>	<b>824-00</b>	10-56
10 SERIES MALE NIPPLE - PARKER	<b>GND</b>	<b>825-00</b>	10-56
10 SERIES HOSE BARB COUPLERS - PARKER	<b>GPD</b>	<b>826-00</b>	10-57
10 SERIES HOSE BARB NIPPLE - PARKER	<b>GVD</b>	<b>827-00</b>	10-57
10 SERIES PUSH-LOK COUPLERS - PARKER	<b>GUD</b>	<b>828-00</b>	10-57
10 SERIES PUSH-LOK NIPPLE - PARKER	<b>GSD</b>	<b>829-00</b>	10-57
60 SERIES HYDRAULIC COUPLERS/NIPPLES - PARKER	<b>JGZ</b>	<b>853-00</b>	10-57

(CONTINUED...)

# SECTION 10 PRODUCT INDEX



## QUICK COUPLERS, BLOW GUNS - AIR & HYDRAULIC (continued)

Line Description	Alpha	Line#	Page#
6600 SERIES HYDRAULIC HI-PRES COUPLERS - PARKER	<b>AXX</b>	<b>853-10</b>	10-57
6600 SERIES HYDRAULIC HI-PRES NIPPLES - PARKER	<b>AXY</b>	<b>853-11</b>	10-58
50 SERIES AIR FEMALE COUPLERS - PARKER	<b>HAD</b>	<b>863-00</b>	10-58
50 SERIES AIR MALE COUPLERS - PARKER	<b>HAD</b>	<b>864-00</b>	10-58
50 SERIES AIR FEMALE NIPPLE - PARKER	<b>HBD</b>	<b>865-00</b>	10-58
50 SERIES AIR MALE NIPPLE - PARKER	<b>HDB</b>	<b>866-00</b>	10-58
50 SERIES AIR PUSH-LOK COUPLERS - PARKER	<b>HAD</b>	<b>867-00</b>	10-58
50 SERIES AIR PUSH-LOK NIPPLE - PARKER	<b>HBD</b>	<b>869-00</b>	10-58
70 SERIES FEMALE COUPLERS - PARKER	<b>HCD</b>	<b>870-00</b>	10-58
70 SERIES MALE COUPLERS - PARKER	<b>HCD</b>	<b>871-00</b>	10-58
70 SERIES AIR FEMALE NPT NIPPLE - PARKER	<b>HDD</b>	<b>872-00</b>	10-58
70 SERIES AIR MALE NPT NIPPLE - PARKER	<b>HDD</b>	<b>873-00</b>	10-58
30 SERIES AIR FEMALE COUPLERS - PARKER	<b>ADF</b>	<b>874-00</b>	10-59
30 SERIES AIR MALE COUPLERS - PARKER	<b>ADG</b>	<b>874-01</b>	10-59
30 SERIES AIR HOSE BARB COUPLERS - PARKER	<b>ADH</b>	<b>874-02</b>	10-59
30 SERIES AIR HOSE PUSH-LOK COUPLERS - PARKER	<b>ADJ</b>	<b>874-03</b>	10-59
EZ MATE FEMALE COUPLERS - PARKER	<b>ADL</b>	<b>874-06</b>	10-59
BLOW GUNS FULL FLOW - PARKER	<b>AXC</b>	<b>875-00</b>	10-59
BLOW GUNS 2/WAY VALVE LEVER TYPE - PARKER	<b>AXC</b>	<b>875-01</b>	10-60
BLOW GUNS CONTROL FLOW TYPE - PARKER	<b>AXC</b>	<b>876-00</b>	10-60
BLOW GUNS 1/4 CONTROL FLOW TYPE - PARKER	<b>AXC</b>	<b>877-00</b>	10-60
AIR LINE FILTERS - PARKER	<b>JBV</b>	<b>877-01</b>	10-60
AIR KING HOSE BARB END CLAMPS MAL IRON	<b>ALZ</b>	<b>879-10</b>	10-60
AIR KING HOSE BARB END COUPLER MAL IRON	<b>AMU</b>	<b>879-11</b>	10-60
AIR KING NPT MALE COUPLER END MAL IRON	<b>AMV</b>	<b>879-12</b>	10-60
AIR KING NPT FEMALE COUPLER END MAL IRON	<b>AMW</b>	<b>879-13</b>	10-60
AIR KING COUPLING SEALING WASHERS	<b>AMX</b>	<b>879-14</b>	10-60
4000 SERIES PIONEER HYDRAULIC COUPLER - PARKER	<b>ADV</b>	<b>880-00</b>	10-60
4000 SERIES PIONEER HYDRAULIC NIPPLE - PARKER	<b>ADW</b>	<b>880-01</b>	10-60
4000 SERIES PIONEER DUST PLUG - PARKER	<b>ADX</b>	<b>880-02</b>	10-61
4000 SERIES PIONEER DUST CAP - PARKER	<b>ADY</b>	<b>880-03</b>	10-61
5000 SERIES HYDRAULIC COUPLERS - PARKER	<b>ADZ</b>	<b>880-06</b>	10-61
5000 SERIES HYDRAULIC NIPPLES - PARKER	<b>AEB</b>	<b>880-07</b>	10-61
FF SERIES NON SPILL HYD COUPLERS - PARKER	<b>JPU</b>	<b>880-10</b>	10-61
FF SERIES NON SPILL HYD NIPPLES - PARKER	<b>JSU</b>	<b>880-11</b>	10-61
NS SERIES NON SPILL HYD COUPLERS - PARKER	<b>JVU</b>	<b>880-12</b>	10-61
NS SERIES NON SPILL HYD NIPPLES - PARKER	<b>JZU</b>	<b>880-13</b>	10-61
ST SERIES FULL FLOW COUPLER/NIPPLES - PARKER	<b>BJH</b>	<b>880-14</b>	10-62
GARDEN HOSE THREAD WATER SERVICE COUPLER - PARKER	<b>BJJ</b>	<b>880-15</b>	10-62

# SECTION 10 PRODUCT INDEX

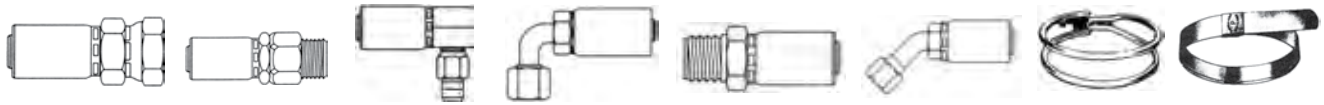

## PARFLEX FITTINGS

Line Description	Alpha	Line#	Page#
PH55 SERIES PARFLEX MALE PIPE CRIMP FITTING - PARKER	<b>AGY</b>	<b>880-20</b>	10-62
PH58 SERIES PARFLEX MALE PIPE CRIMP FITTING - PARKER	<b>AGZ</b>	<b>880-21</b>	10-63
PH55 SERIES PARFLEX FEMALE PIPE CRIMP FITTING - PARKER	<b>AHB</b>	<b>880-22</b>	10-63
PH55 SERIES PARFLEX MALE 37° JIC CRIMP FITTING - PARKER	<b>AHD</b>	<b>880-23</b>	10-63
PH58 SERIES PARFLEX MALE 37° JIC CRIMP FITTING - PARKER	<b>AHE</b>	<b>880-24</b>	10-63
PH55 SERIES PARFLEX MALE 45° SAE CRIMP FITTING - PARKER	<b>AHF</b>	<b>880-25</b>	10-63
PH58 SERIES PARFLEX MALE 45° SAE CRIMP FITTING - PARKER	<b>AHG</b>	<b>880-26</b>	10-63
PH55 SERIES PARFLEX STRA THD O-RING CRIMP FITTING - PARKER	<b>AHH</b>	<b>880-27</b>	10-63
PH55 SERIES PARFLEX FEMALE 37° JIC CRIMP FITTING - PARKER	<b>AHJ</b>	<b>880-28</b>	10-64
PH58 SERIES PARFLEX FEMALE 37° JIC CRIMP FITTING - PARKER	<b>AHK</b>	<b>880-29</b>	10-64
PH55 SERIES PARFLEX FEMALE PIPE SWIVEL CRIMP FITTING- PARKER	<b>AHL</b>	<b>880-30</b>	10-64
PH55 SERIES PARFLEX FEMALE 45° SWIVEL SAE CRIMP FIT - PARKER	<b>AHM</b>	<b>880-31</b>	10-64
PH58 SERIES PARFLEX FEMALE 45° SWIVEL SAE CRIMP FIT - PARKER	<b>AHN</b>	<b>880-32</b>	10-64
PH55 SERIES PARFLEX MALE PIPE SWIVEL CRIMP FITTING- PARKER	<b>AHP</b>	<b>880-33</b>	10-64
PH58 SERIES PARFLEX MALE PIPE SWIVEL CRIMP FITTING- PARKER	<b>AHR</b>	<b>880-34</b>	10-64
PH55 SERIES PARFLEX MALE 90° PIPE SWIVEL CRIMP FIT - PARKER	<b>AHT</b>	<b>880-35</b>	10-64
PH55 SER PARFLEX MLE 45° ELB 37° JIC SWVL CRIMP FIT- PARKER	<b>AHV</b>	<b>880-36</b>	10-65
PH58 SER PARFLEX MLE 45° ELB 37° JIC SWVL CRIMP FIT- PARKER	<b>AHW</b>	<b>880-37</b>	10-65
PH55 SER PARFLEX MLE 90° ELB 37° JIC SWVL CRIMP FIT- PARKER	<b>AHX</b>	<b>880-38</b>	10-65
PH58 SER PARFLEX MLE 90° ELB 37° JIC SWVL CRIMP FIT- PARKER	<b>AHY</b>	<b>880-39</b>	10-65
PH55 SER PARFLEX LONG 90° ELB 37° JIC SWVL CRIMP FIT-PARKER	<b>AHZ</b>	<b>880-40</b>	10-65
PH58 SER PARFLEX LONG 90° ELB 37° JIC SWVL CRIMP FIT-PARKER	<b>AJB</b>	<b>880-41</b>	10-65
PH91 SERIES PARFLEX MALE PIPE THD STEEL CRIMP FITTING-PARKER	<b>AJD</b>	<b>880-42</b>	10-65
PH91 SERIES PARFLEX MLE PIPE THD STAINLESS CRIMP FITT-PARKER	<b>AJE</b>	<b>880-43</b>	10-66
PH91 SERIES PARFLEX FEM JIC SWIVEL-STEEL CRIMP FITT-PARKER	<b>AJG</b>	<b>880-45</b>	10-66
PH91 SERIES PARFLEX FEM JIC SWIVEL - ST/STEEL - PARKER	<b>AJH</b>	<b>880-46</b>	10-66
PH91 SERIES PARFLEX FEM SAE SWIVEL - STEEL - PARKER	<b>AJJ</b>	<b>880-47</b>	10-66
PH91 SERIES PARFLEX AIR BRAKE TUBE - STEEL - PARKER	<b>AJK</b>	<b>880-48</b>	10-66
PH91 SERIES PARFLEX AIR BRAKE COMP END - BRS/STEEL - PARKER	<b>AJL</b>	<b>880-49</b>	10-66
PH55 SERIES PARFLEX SEAL-LOK STRA SHORT - PARKER	<b>BGN</b>	<b>880-54</b>	10-66
PH55 SERIES PARFLEX SEAL-LOK STRAIGHT - PARKER	<b>ATP</b>	<b>880-55</b>	10-66
PH55 SERIES PARFLEX SEAL-LOK 90° ELBOW LONG - PARKER	<b>ATR</b>	<b>880-56</b>	10-66
PH55 SERIES PARFLEX SEAL-LOK 45° ELBOW - PARKER	<b>ATS</b>	<b>880-57</b>	10-67
PH55 SERIES PARFLEX SEAL-LOK 90° ELBOW SHORT - PARKER	<b>BEN</b>	<b>880-58</b>	10-67
PH 92 SERIES PARFLEX PTH MARINE HOSE FITTING S/S - PARKER	<b>ASE</b>	<b>880-75</b>	10-67
UNIVERSAL SURE SEAL HI-PRESSURE HOSE CLAMP	<b>SSC</b>	<b>880-99</b>	10-67
J-LOCK BAND CLAMPS - STAINLESS	<b>AZW</b>	<b>881-00</b>	10-67
BANDIT PUNCH-LOK STEEL CLAMPS	<b>JHH</b>	<b>881-01</b>	10-67
BANDIT PUNCH-LOK STAINLESS CLAMPS	<b>JIH</b>	<b>881-02</b>	10-68



# SECTION 10 PRODUCT INDEX

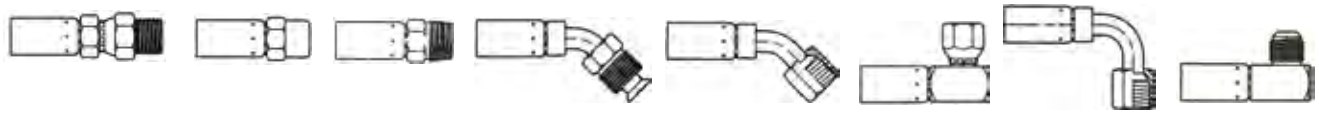

## DANA HOSE CRIMP FITTINGS (USE WITH H017 HOSE - FLB)

Line Description	Alpha	Line#	Page#
COLL-O-CRIMP U SERIES MALE PIPE FITTING - DANA	<b>JTK</b>	<b>881-03</b>	10-68
COLL-O-CRIMP U SERIES JIC FEMALE SWIVEL - DANA	<b>JUK</b>	<b>881-04</b>	10-68
COLL-O-CRIMP U SERIES JIC FEMALE ELBOW SWIVEL - DANA	<b>JVK</b>	<b>881-05</b>	10-69
COLL-O-CRIMP U SERIES JIC MALE RIGID - DANA	<b>JWK</b>	<b>881-06</b>	10-69
COLL-O-CRIMP U SERIES 45° JIC ELBOW SWIVEL - DANA	<b>JXK</b>	<b>881-07</b>	10-69
COLL-O-CRIMP U SERIES FLARELESS NUT/SLV ASSM - DANA	<b>JYK</b>	<b>881-08</b>	10-69
COLL-O-CRIMP U SERIES MALE INVERTED SWIVEL CONN - DANA	<b>JZK</b>	<b>881-09</b>	10-69
COLL-O-CRIMP U SERIES 45° INVERTED SWIVEL ELBOW - DANA	<b>JAL</b>	<b>881-10</b>	10-70
COLL-O-CRIMP U SERIES 90° INVERTED SWIVEL ELBOW - DANA	<b>JBL</b>	<b>881-11</b>	10-70
COLL-O-CRIMP U SERIES MALE PIPE SWIVEL - DANA	<b>JCL</b>	<b>881-12</b>	10-70
COLL-O-CRIMP U SERIES MALE STRA O-RING SWIVEL - DANA	<b>JFL</b>	<b>881-15</b>	10-70
COLL-O-CRIMP U SERIES MALE STRA O-RING RIGID - DANA	<b>JGL</b>	<b>881-16</b>	10-70
COLL-O-CRIMP U SERIES 90° MALE STRA O-RING SWIVEL - DANA	<b>JHL</b>	<b>881-17</b>	10-70
COLL-O-CRIMP U SERIES 90° MALE PIPE SWIVEL - DANA	<b>JWS</b>	<b>881-18</b>	10-71
COLL-O-CRIMP U SERIES STRA FEMALE PIPE RIGID - DANA	<b>JXS</b>	<b>881-19</b>	10-71
COLL-O-CRIMP U SERIES STRA FEMALE PIPE SWIVEL - DANA	<b>JYS</b>	<b>881-20</b>	10-71
COLL-O-CRIMP U SERIES FEMALE STRA THD PIPE SWIVEL - DANA	<b>JZS</b>	<b>881-21</b>	10-71
COLL-O-CRIMP U SERIES MALE JIC 90° RIGID - DANA	<b>JAT</b>	<b>881-22</b>	10-71
COLL-O-CRIMP U SERIES FEMALE JIC 90° SWIVEL - DANA	<b>JBT</b>	<b>881-23</b>	10-71
COLL-O-CRIMP U SERIES SEAL-LOK STRA FEMALE SWIVEL - DANA	<b>BSY</b>	<b>881-35</b>	10-71
COLL-O-CRIMP U SERIES SEAL-LOK 45° ELBOW FEMALE SWVL - DANA	<b>BSZ</b>	<b>881-36</b>	10-71
COLL-O-CRIMP U SERIES SEAL-LOK 90° SHORT ELBOW FEM SWVL-DANA	<b>BTD</b>	<b>881-37</b>	10-72
COLL-O-CRIMP U SERIES SEAL-LOK 90° LONG/MED FEM SWVL-DANA	<b>BTE</b>	<b>881-38</b>	10-72



## PARKER HOSE CRIMP FITTINGS

Line Description	Alpha	Line#	Page#
71 SERIES FEMALE SWIVL SEAL-LOK MED 90° ELBOW - PARKER (4 WIRE)	<b>BGL</b>	<b>881-39</b>	10-72
71 SERIES MALE PIPE HI-PRESSURE CRIMP FITTING - PARKER (4 WIRE)	<b>AUZ</b>	<b>881-40</b>	10-72
71 SERIES JIC MALE RIGID CRIMP FITTING - PARKER (4 WIRE)	<b>AVD</b>	<b>881-41</b>	10-72
71 SERIES O-RING STRA THREAD CRIMP FITTING - PARKER (4 WIRE)	<b>AVE</b>	<b>881-42</b>	10-72
71 SERIES STRA JIC FEMALE SWIVEL CRIMP FITTING - PARKER (4 WIRE)	<b>AVF</b>	<b>881-43</b>	10-73
71 SERIES 45° ELBOW JIC FEMALE SWIVEL CRIMP FITTING - PARKER (4 WIRE)	<b>AVG</b>	<b>881-44</b>	10-73
71 SERIES 90° ELBOW JIC FEMALE SWIVEL CRIMP FITTING - PARKER (4 WIRE)	<b>AVH</b>	<b>881-45</b>	10-73
71 SERIES 90° FLANGE ELBOW SAE/61 FLNG CRIMP FITTING- PARKER (4 WIRE)	<b>AVJ</b>	<b>881-46</b>	10-73
71 SERIES STRA FLANGE SAE/61 FLNG CRIMP FITTING - PARKER (4 WIRE)	<b>AVK</b>	<b>881-47</b>	10-73
71 SERIES 45° FLANGE SAE/61 FLNG CRIMP FITTING - PARKER (4 WIRE)	<b>AVL</b>	<b>881-48</b>	10-73
71 SERIES STRA #62 FLANGE CRIMP FITTING - PARKER (4 WIRE)	<b>AVM</b>	<b>881-49</b>	10-74

(CONTINUED...)

# SECTION 10 PRODUCT INDEX



## PARKER HOSE CRIMP FITTINGS (continued)

Line Description	Alpha	Line#	Page#
71 SERIES 45° ELBOW #62 FLANGE CRIMP FITTING - PARKER (4 WIRE)	<b>AVN</b>	<b>881-50</b>	10-74
71 SERIES 90° ELBOW #62 FLANGE CRIMP FITTING - PARKER (4 WIRE)	<b>AVP</b>	<b>881-51</b>	10-74
71 SERIES 22 1/2° ELBOW #61 FLANGE CRIMP FITTING - PARKER (4 WIRE)	<b>BGE</b>	<b>881-52</b>	10-74
71 SERIES 30° ELBOW #61 FLANGE CRIMP FITTING - PARKER (4 WIRE)	<b>BGF</b>	<b>881-53</b>	10-74
71 SERIES 67 1/2° ELBOW #61 FLANGE CRIMP FITTING - PARKER (4 WIRE)	<b>BGG</b>	<b>881-54</b>	10-74
71 SERIES FEMALE SEAL-LOK STRA SWIVEL CRIMP FITTING - PARKER (4 WIRE)	<b>BGH</b>	<b>881-55</b>	10-74
71 SERIES FEM SEAL-LOK 45° SWV ELB H/P CRIMP FITTING- PARKER (4 WIRE)	<b>BGJ</b>	<b>881-56</b>	10-74
71 SER FEM SEAL-LOK 90° SHORT SWV ELB H/P CRIMP FITT-PARKER (4 WIRE)	<b>BGK</b>	<b>881-57</b>	10-75
43 SERIES FEM JIC MED 90° SWV ELBOW CRIMP FITTING - PARKER (1-2 WIRE)	<b>BPY</b>	<b>881-63</b>	10-75
43 SERIES FEM NPSM PIPE SWIVEL STRA CRIMP FITTING - PARKER (1-2 WIRE)	<b>AYS</b>	<b>881-64</b>	10-75
43 SERIES MALE PIPE THREAD CRIMP FITTING - PARKER (1-2 WIRE)	<b>AKS</b>	<b>881-65</b>	10-75
43 SERIES MALE 37° JIC RIGID CRIMP FITTING - PARKER (1-2 WIRE)	<b>AKT</b>	<b>881-66</b>	10-75
43 SERIES MALE O-RING THD STRA CRIMP FITTING - PARKER (1-2 WIRE)	<b>AKV</b>	<b>881-67</b>	10-76
43 SERIES FEMALE 37°/45° SWIVEL STRA CRIMP FITTING - PARKER (1-2 WIRE)	<b>AKW</b>	<b>881-68</b>	10-76
43 SERIES FURRUL-FIX FLARELESS CRIMP FITTING - PARKER (1-2 WIRE)	<b>AKX</b>	<b>881-69</b>	10-76
43 SERIES SAE FLARELESS SWIVEL NUT CRIMP FITTING - PARKER (1-2 WIRE)	<b>AKY</b>	<b>881-70</b>	10-76
43 SERIES MALE PIPE NPTF SWIVEL CRIMP FITTING - PARKER (1-2 WIRE)	<b>AKZ</b>	<b>881-71</b>	10-76
43 SERIES STRA FLANGE SAE #61 FLANGE CRIMP FITTING - PARKER (1-2 WIRE)	<b>ALD</b>	<b>881-72</b>	10-76
43 SERIES 45° FLANGE SAE #61 FLANGE CRIMP FITTING - PARKER (1-2 WIRE)	<b>ALE</b>	<b>881-73</b>	10-77
43 SERIES 90° FLANGE SAE #61 FLANGE CRIMP FITTING - PARKER (1-2 WIRE)	<b>ALF</b>	<b>881-74</b>	10-77
43 SERIES INVERTED FLARE STRA SWIVEL CRIMP FITTING - PARKER (1-2 WIRE)	<b>ALG</b>	<b>881-75</b>	10-77
43 SERIES 45° ELBOW JIC 37° SWIVEL CRIMP FITTING - PARKER (1-2 WIRE)	<b>ALH</b>	<b>881-76</b>	10-77
43 SERIES 90° ELBOW JIC 37° SWIVEL CRIMP FITTING - PARKER (1-2 WIRE)	<b>ALJ</b>	<b>881-77</b>	10-77
43 SERIES LONG 90° ELB JIC 37° SWIVEL CRIMP FITTING - PARKER (1-2 WIRE)	<b>ALK</b>	<b>881-78</b>	10-77
43 SERIES INVERTED FLARE 45° ELB SWVL CRIMP FITTING - PARKER (1-2 WIRE)	<b>ALL</b>	<b>881-79</b>	10-77
43 SERIES INVERTED FLARE 90° ELB SWVL CRIMP FITTING - PARKER (1-2 WIRE)	<b>ALM</b>	<b>881-80</b>	10-78
43 SERIES SAE FLARE FEM 45° SWVL ELB CRIMP FITTING - PARKER (1-2 WIRE)	<b>ALN</b>	<b>881-81</b>	10-78
43 SERIES SAE FLARE FEM 90° SWVL ELB CRIMP FITTING - PARKER (1-2 WIRE)	<b>ALP</b>	<b>881-82</b>	10-78
PARKRIMP 1/2 FLANGE KIT #61/#62 - PARKER (1-2 WIRE)	<b>ALS</b>	<b>881-84</b>	10-78
PARKRIMP FULL FLANGE KIT #61/#62 - PARKER (1-2 WIRE)	<b>ALT</b>	<b>881-85</b>	10-78
43 SERIES SEAL-LOK STRA SWIVEL - PARKER (1-2 WIRE)	<b>ATV</b>	<b>881-86</b>	10-78
43 SERIES SEAL-LOK 45° FEMALE ELBOW SWIVEL - PARKER (1-2 WIRE)	<b>ATW</b>	<b>881-87</b>	10-79
43 SERIES SEAL-LOK 90° FEMALE ELBOW SWIVEL - PARKER (1-2 WIRE)	<b>ATX</b>	<b>881-88</b>	10-79
43 SERIES MALE SEAL-LOK STRA CRIMP FITTING - PARKER (1-2 WIRE)	<b>BBG</b>	<b>881-89</b>	10-79
43 SERIES METRIC FEM JIS STRA SWIVEL CRIMP FITTING - PARKER (1-2 WIRE)	<b>BBH</b>	<b>881-90</b>	10-80
43 SERIES METRIC MALE STUD STRAIGHT CRIMP FITTING - PARKER (1-2 WIRE)	<b>BBJ</b>	<b>881-91</b>	10-80
43 SERIES METRIC FEM SWIVEL STRA LIGHT CRIMP FITTING- PARKER (1-2 WIRE)	<b>BBK</b>	<b>881-92</b>	10-80
43 SERIES SEAL-LOK MED/TANG 90° FEMALE SWIVEL - PARKER (1-2 WIRE)	<b>BCD</b>	<b>881-93</b>	10-80
43 SERIES SEAL-LOK SHORT STRA SWIVEL - PARKER (1-2 WIRE)	<b>BFE</b>	<b>881-94</b>	10-80
43 SERIES SEAL-LOK LONG 90° FEMALE SWIVEL - PARKER (1-2 WIRE)	<b>BFF</b>	<b>881-95</b>	10-81

(CONTINUED...)

# SECTION 10 PRODUCT INDEX



## PARKER HOSE CRIMP FITTINGS *(continued)*

Line Description	Alpha	Line#	Page#
43 SERIES SEAL-LOK 22 1/2 ELBOW FEMALE SWIVEL - PARKER (1-2 WIRE)	<b>BFG</b>	<b>881-96</b>	10-81
43 SERIES METRIC O-RING HVY SWIVL STRA CRIMP FITTING- PARKER (1-2 WIRE)	<b>BFN</b>	<b>881-97</b>	10-81
43 SERIES METRIC O-RING HVY SWIVL 45° ELB CRIMP FITT- PARKER (1-2 WIRE)	<b>BFP</b>	<b>882-00</b>	10-81
43 SERIES METRIC O-RING HVY SWIVL 90° ELB CRIMP FITT- PARKER (1-2 WIRE)	<b>BFR</b>	<b>882-01</b>	10-81
43 SERIES METRIC FEM LITE SWIVL 45° ELB CRIMP FITT- PARKER (1-2 WIRE)	<b>BFH</b>	<b>882-02</b>	10-81
43 SERIES METRIC FEM LITE SWIVL 90° ELB CRIMP FITT- PARKER (1-2 WIRE)	<b>BFJ</b>	<b>882-03</b>	10-81
43 SERIES METRIC FEM SWIVL LITE O-RING STRA CRIMP FIT-PARKER (1-2 WIRE)	<b>BFK</b>	<b>882-04</b>	10-81
43 SERIES METRIC FEM SWIVL LITE O-RING 45° CRIMP FITT-PARKER (1-2 WIRE)	<b>BKE</b>	<b>882-05</b>	10-82
43 SERIES METRIC FEM SWIVL LITE O-RING 90° CRIMP FITT-PARKER (1-2 WIRE)	<b>BKF</b>	<b>882-06</b>	10-82
43 SERIES METRIC MALE STUD HEAVY STRA CRIMP FITTING - PARKER (1-2 WIRE)	<b>BFL</b>	<b>882-07</b>	10-82
43 SERIES METRIC FEM STRA HEAVY SWVL CRIMP FITTING - PARKER (1-2 WIRE)	<b>BFM</b>	<b>882-08</b>	10-82
43 SERIES MM BSP PARALLEL STRA THD CRIMP FITTING - PARKER (1-2 WIRE)	<b>BFT</b>	<b>882-09</b>	10-82
43 SERIES MF BSP SWIVL BALLNOSE STRA CRIMP FITTING - PARKER (1-2 WIRE)	<b>BFV</b>	<b>882-10</b>	10-82
43 SERIES MF BSP SWIVL BALLNOSE 45° CRIMP FITTING - PARKER (1-2 WIRE)	<b>BFW</b>	<b>882-11</b>	10-82
43 SERIES MF BSP SWIVL BALLNOSE 90° CRIMP FITTING - PARKER (1-2 WIRE)	<b>BFX</b>	<b>882-12</b>	10-82
43 SER METRIC JIS/BSP TAPER PIPE MLE RIGID CRIMP FIT-PARKER (1-2 WIRE)	<b>BFY</b>	<b>882-13</b>	10-83
43 SERIES METRIC FEM SWIVL BSP/JIS PARL 60° CONE STRA-PARKER (1-2 WIRE)	<b>BFZ</b>	<b>882-14</b>	10-83
43 SERIES METRIC FEM SWIVL BSP/JIS PARL 30° CONE STRA-PARKER (1-2 WIRE)	<b>BGD</b>	<b>882-15</b>	10-83
71 SERIES METRIC O-RING FEM SWIVL HVY STRA CRIMP FITT-PARKER (4 WIRE)	<b>BRF</b>	<b>882-30</b>	10-83
71 SER. METRIC BSP/JIS HVY TAPER STRA RIGID CRIMP FIT-PARKER (4 WIRE)	<b>BRJ</b>	<b>882-33</b>	10-83
71 SERIES METRIC FEM JIS 30° FLARE SWIVEL CRIMP - PARKER (4 WIRE)	<b>BRK</b>	<b>882-34</b>	10-83
71 SERIES METRIC FEM BSPP 60° STRAIGHT SWIVEL CRIMP - PARKER (4 WIRE)	<b>BRP</b>	<b>882-38</b>	10-83
71 SERIES METRIC FEM BSPP 30° CONE STRA SWIVL CRIMP - PARKER (4 WIRE)	<b>BRR</b>	<b>882-39</b>	10-83
78 SERIES MALE PIPE RIGID STRAIGHT CRIMP - PARKER (6 WIRE)	<b>BXL</b>	<b>882-50</b>	10-84
78 SERIES FEMALE JIC SWIVEL STRAIGHT CRIMP - PARKER (6 WIRE)	<b>BXM</b>	<b>882-51</b>	10-84
78 SERIES FEMALE JIC SWIVEL 90° ELBOW CRIMP - PARKER (6 WIRE)	<b>BXN</b>	<b>882-52</b>	10-84
78 SERIES FLANGE #61 STRAIGHT CRIMP - PARKER (6 WIRE)	<b>BXP</b>	<b>882-53</b>	10-84
78 SERIES FLANGE #61 45° ELBOW CRIMP - PARKER (6 WIRE)	<b>BXR</b>	<b>882-54</b>	10-84
78 SERIES FLANGE #61 90° ELBOW CRIMP - PARKER (6 WIRE)	<b>BXT</b>	<b>882-55</b>	10-84
78 SERIES FLANGE #62 STRAIGHT CRIMP - PARKER (6 WIRE)	<b>BXV</b>	<b>882-56</b>	10-84
78 SERIES FLANGE #62 22 1/2° ELBOW CRIMP - PARKER (6 WIRE)	<b>BXW</b>	<b>882-57</b>	10-84
78 SERIES FLANGE #62 45° ELBOW CRIMP - PARKER (6 WIRE)	<b>BXX</b>	<b>882-58</b>	10-84
78 SERIES FLANGE #62 90° ELBOW CRIMP - PARKER (6 WIRE)	<b>BXY</b>	<b>882-59</b>	10-85
78 SERIES SEAL-LOK LONG STRAIGHT SWIVEL FEM CRIMP - PARKER (6 WIRE)	<b>BXZ</b>	<b>882-60</b>	10-85
78 SERIES SEAL-LOK 45° ELBOW SWIVEL FEMALE CRIMP - PARKER (6 WIRE)	<b>BYD</b>	<b>882-61</b>	10-85
78 SERIES SEAL-LOK 90° ELBOW SWIVEL FEMALE CRIMP - PARKER (6 WIRE)	<b>BYE</b>	<b>882-62</b>	10-85
78 SERIES METRIC MALE STUD HEAVY STRAIGHT CRIMP - PARKER (6 WIRE)	<b>BYF</b>	<b>882-65</b>	10-85
78 SERIES METRIC FEMALE HEAVY SWIVEL STRAIGHT CRIMP - PARKER (6 WIRE)	<b>BYG</b>	<b>882-66</b>	10-85
78 SERIES METRIC FEMALE HEAVY SWIVEL 45° ELB CRIMP - PARKER (6 WIRE)	<b>BYH</b>	<b>882-67</b>	10-85
78 SERIES METRIC FEMALE HEAVY SWIVEL 90° ELB CRIMP - PARKER (6 WIRE)	<b>BYJ</b>	<b>882-68</b>	10-85
78 SERIES METRIC BSP/JIS 60° P/P FE/SWIVEL CRIMP - PARKER (6 WIRE)	<b>BYK</b>	<b>882-69</b>	10-85

### MINI-BARB UNION

BRASS

Line: 560-00

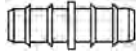

PART NUMBER	SIZE	QTY/BX	LIST PRICE
SYA22X532	5/32 (22-5/32)	100	
SYA1062X4	1/4 (22-4)	5	
SYA1062X4X3	1/4 X 3/16	5	
SYA1062X6	3/8 (22-6)	5	
SYA1062X8	1/2 (22-8)	5	

### MINI-BARB UNION TEE

BRASS

Line: 562-00

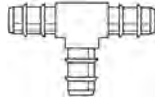

PART NUMBER	SIZE	QTY/BX	LIST PRICE
SZA224X532	5/32 (224-5/32)	50	
SZA1064X4	1/4 (224-4)	5	
SZA1064X6	3/8 X 1/4 X 3/8 (224-6)	5	
SZA1064X664	3/8 X 3/8 X 1/4	5	
SZA1064X686	3/8 X 1/2 X 3/8	5	
SZA1064X8	1/2 (224-8)	5	
SZA1064X884	1/2 X 1/2 X 1/4	5	
SZA1064X886	1/2 X 1/2 X 3/8	5	

### MINI-BARB UNION ELBOW

BRASS

Line: 563-00



PART NUMBER	SIZE	QTY/BX	LIST PRICE
TAA1065X4	1/4 (225-4)	5	

### MINI-BARB FEMALE CONNECTOR

BRASS

Line: 564-00

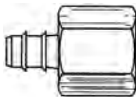

PART NUMBER	SIZE	QTY/BX	LIST PRICE
TBA1066X4	1/4 X 1/8 (26-4-2)	5	
TBA1066X4X4	1/4 X 1/4	5	
TBA1066X6	3/8 X 1/4 (26-6-4)	5	

### MINI-BARB MALE CONNECTOR

BRASS

Line: 565-00

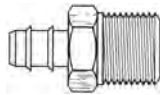

PART NUMBER	SIZE	QTY/BX	LIST PRICE
TCA1068X2A	1/8 X 10/32	5	
TCA1068X252	5/32 X 1/8	5	
TCA1068X4X1	1/4 X 1/16 (28-4-1)	5	
TCA1068X4	1/4 X 1/8 (28-4-2)	5	
TCA1068X4X4	1/4 X 1/4 (28-4-4)	5	
TCA1068X6	3/8 X 1/4 (28-6-4)	5	
TCA1068X6X2	3/8 X 1/8	5	
TCA1068X6X8	3/8 X 1/2	5	
TCA1068X8	1/2 X 3/8	5	

### MINI-BARB MALE ELBOW

BRASS

Line: 566-00



PART NUMBER	SIZE	QTY/BX	LIST PRICE
TDA1069X4	1/4 X 1/8 (229-4-2)	5	
TDA1069X4X4	1/4 X 1/4	5	
TDA1069X6X2	3/8 X 1/8	5	
TDA1069X6	3/8 X 1/4 (229-6-4)	5	

### MINI-BARB FEMALE ELBOW

BRASS

Line: 567-00

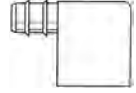

PART NUMBER	SIZE	QTY/BX	LIST PRICE
TEA1070X4	1/4 X 1/8	5	
TEA1070X4X4	1/4 X 1/4	5	

### MINI-BARB MALE RUN TEE

BRASS

Line: 568-00

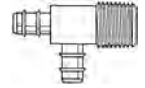

PART NUMBER	SIZE	QTY/BX	LIST PRICE
TFA1071X4	1/4 X 1/8	5	
TFA1071X6	3/8 X 1/4	5	

### MINI-BARB MALE BRANCH TEE

BRASS

Line: 569-00



PART NUMBER	SIZE	QTY/BX	LIST PRICE
TGA1072X4	1/4 X 1/8	5	
TGA1072X6	3/8 X 1/4	5	
TGA1072X8	1/2 X 3/8	5	

### MINI-BARB FEMALE BRANCH TEE

BRASS

Line: 570-00

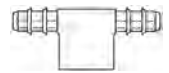

PART NUMBER	SIZE	QTY/BX	LIST PRICE
TJA1077X4	1/4 X 1/8	5	



**CALL - 1 (800) 723-2826**

## PUSH-ON MALE PIPE

LOW PRESSURE BRASS

Line: 571-00

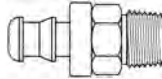

PART NUMBER	SIZE	QTY/BX	LIST PRICE
UAA4B-102	1/4 X 1/8 (30182-2-4B)	10	
UAA4B-104	1/4 X 1/4 (30182-4-4B)	10	
UAA5B-102	5/16 X 1/8	10	
UAA5B-104	5/16 X 1/4	10	
UAA6B-102	3/8 X 1/8	10	
UAA6B-104	3/8 X 1/4 (30182-4-6B)	10	
UAA6B-106	3/8 X 3/8 (30182-6-6B)	10	
UAA3018286	3/8 X 1/2 (30182-8-6B)	10	
UAA8B-106	1/2 X 3/8 (30182-6-8B)	10	
UAA8B-108	1/2 X 1/2 (30182-8-8B)	10	
UAA10B-108	5/8 X 1/2 (30182-8-10B)	10	
UAA12B-112	3/4 X 3/4 (30182-12-12B)	10	

## PUSH-ON SAE FLARE MALE

LOW PRESSURE BRASS

Line: 572-00

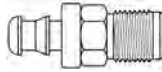

PART NUMBER	SIZE	QTY/BX	LIST PRICE
UBA4B-304	1/4 X 1/4 (30482-4-4B)	10	
UBA4B-305	1/4 X 5/16 (30482-5-4B)	10	
UBA5B-305	5/16 X 5/16	10	
UBA6B-306	3/8 X 3/8 (30482-6-6B)	10	
UBA3038288	1/2 X 1/2	5	

## PUSH-ON SAE FLARE FEMALE SWIVEL

LOW PRESSURE BRASS

Line: 573-00

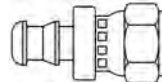

PART NUMBER	SIZE	QTY/BX	LIST PRICE
UCA4B-404	1/4 X 1/4 (30682-4-4B)	10	
UCA4B-405	1/4 X 5/16 (30682-5-4B)	10	
UCA5B-405	5/16 X 5/16	10	
UCA6B-405	3/8 X 5/16	10	
UCA6B-406	3/8 X 3/8 (30882-6-6B)	10	
UCA8B-408	1/2 X 1/2 (30682-8-8B)	10	
UCA30882108	1/2 X 5/8	5	
UCA10B-410	5/8 X 5/8 (30682-10-10B)	10	
UCA12B-412	3/4 X 3/4 (30882-12-12B)	10	

**NOTE: PARKER PUSH-LOK STYLE HOSE RECOMMENDED FOR USE WITH PUSH-ON FITTINGS. SEE PG 10-51 (FJB) ALPHA LINE 758-00.**

## PUSH-ON JIC (37°) FLARE FEMALE SWIVEL

LOW PRESSURE BRASS

Line: 574-00

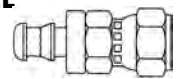

PART NUMBER	SIZE	QTY/BX	LIST PRICE
UDA4B-604	1/4 X 1/4 (30682-4-4B)	10	
UDA3068254	1/4 X 5/16	5	
UDA5B-605	5/16 X 5/16	10	
UDA6B-606	3/8 X 3/8 (30682-6-6B)	10	
UDA3068268	3/8 X 1/2	5	
UDA8B-608	1/2 X 1/2 (30682-8-8B)	10	
UDA30682108	1/2 X 5/8	5	
UDA10B-610	5/8 X 5/8 (30682-10-10B)	10	
UDA12B-612	3/4 X 3/4 (30682-12-12B)	5	

## PUSH-ON INVERTED FLARE FEMALE

LOW PRESSURE BRASS

Line: 575-00

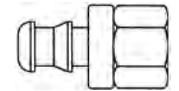

PART NUMBER	SIZE	QTY/BX	LIST PRICE
UEA4B-A03	1/4 X 3/16 (32982-3-4B)	10	
UEA4B-A04	1/4 X 1/4 (32982-4-4B)	10	
UEA4B-A05	1/4 X 5/16 (32982-5-4B)	10	
UEA5B-A05	5/16 X 5/16	10	
UEA6B-A05	3/8 X 5/16	10	
UEA6B-A06	3/8 X 3/8 (32982-6-6B)	10	
UEA8B-A08	1/2 X 1/2 (32982-8-8B)	10	

## PUSH-ON INVERTED FLARE MALE SWIVEL

LOW PRESSURE BRASS

Line: 576-00



PART NUMBER	SIZE	QTY/BX	LIST PRICE
UFA4B-B03	1/4 X 3/16 (32882-3-4)	10	
UFA4B-B04	1/4 X 1/4 (32882-4-4)	10	
UFA4B-B05	1/4 X 5/16 (32882-5-4)	10	
UFA5B-B04	5/16 1/4	10	
UFA5B-B05	5/16 X 5/16	10	
UFA6B-B05	3/8 X 5/16	10	
UFA6B-B06	3/8 X 3/8 (32882-6-6)	10	
UFA8B-B08	1/2 X 1/2 (32882-8-8)	10	
UFA328821010	5/8 X 5/8	5	

## PUSH-ON MALE PIPE THREAD 90° ELBOW

LOW PRESSURE BRASS

Line: 577-00

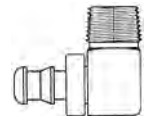

PART NUMBER	SIZE	QTY/BX	LIST PRICE
UGA5B-C02	5/16 X 1/8	10	
UGA5B-C04	5/16 X 1/4	10	
UGA6B-C02	3/8 X 1/8	10	
UGA6B-C04	3/8 X 1/4	10	

**PUSH-ON BARB TO TUBE**

LOW PRESSURE BRASS

Line: 578-00

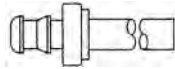

PART NUMBER	SIZE	QTY/BX	LIST PRICE
UHA4B-X03	1/4 X 3/16 (33482-3-4B)	10	
UHA4B-X04	1/4 X 1/4 (337482-4-4B)	10	
UHA4B-X05X	1/4 X 5/16 (33482-5-4)	10	
UHA5B-X05	5/16 X 5/16	10	
UHA6B-X06	3/8 X 3/8 (33482-6-6B)	10	

**PUSH-ON HOSE MENDER**

LOW PRESSURE BRASS

Line: 579-00

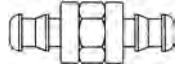

PART NUMBER	SIZE	QTY/BX	LIST PRICE
UJA4B-Y04	1/4	10	
UJA5B-Y05	5/16	10	
UJA6B-Y06	3/8	10	
UJA8B-Y08	1/2	10	

**PUSH-ON FEMALE PIPE SWIVEL**

BRASS

Line: 579-01



PART NUMBER	SIZE	QTY/BX	LIST PRICE
JLS4B-254	1/4 X 1/4 (10004B254)	10	
JLS6B-256	3/8 X 3/8 (10006B256)	10	
JLS8B-258	1/2 X 1/2 (10008B258)	10	

**PUSH-ON MALE PIPE THREAD SWIVEL**

STEEL

Line: 579-02



PART NUMBER	SIZE	QTY/BX	LIST PRICE
ASN31382X44	1/4 BARB X 1/4 PIPE	10	
ASN31382X66	3/8 BARB X 3/8 PIPE	10	
ASN31382X88	1/2 BARB X 1/2 PIPE	10	

**BARB X MALE PIPE THREAD CONNECTOR**

FOR H057 HOSE BRASS

Line: 580-00

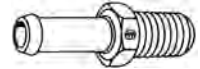

PART NUMBER	SIZE	QTY/BX	LIST PRICE
UKA1541	3/16 X 1/8	5	
UKA1537	1/4 X 1/8	5	
UKA1581	1/4 X 1/4	5	
UKA1551	5/16 X 1/8	5	
UKA1555	5/16 X 1/4	5	
UKA1565	3/8 X 1/8	5	
UKA1564	3/8 X 1/4	5	
UKA1566	3/8 X 3/8	5	

**BARB X 90° ELBOW MALE PIPE THREAD**

FOR H057 HOSE BRASS

Line: 581-00

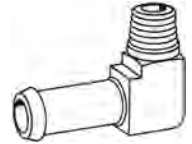

PART NUMBER	SIZE	QTY/BX	LIST PRICE
ULA1582	1/4 X 1/8	5	
ULA1556	5/16 X 1/8	5	
ULA1557	5/16 X 1/4	5	
ULA1571	3/8 X 1/4	5	
ULA1572	3/8 X 1/8	5	

**BARB X INVERTED FLARE MALE ELBOW SWIVEL**

FOR H057 HOSE BRASS

Line: 582-00



PART NUMBER	SIZE	QTY/BX	LIST PRICE
UMA1403	1/4 X 1/4	5	
UMA1407	3/8 X 3/8	5	

**BARB X INVERTED FLARE MALE CONNECTOR**

FOR H057 HOSE BRASS

Line: 583-00



PART NUMBER	SIZE	QTY/BX	LIST PRICE
URA1560	5/16 X 5/16	5	
URA1570	3/8 X 3/8	5	

## HOSE BARB X MALE PIPE THREAD

BRASS PIPE CONNECTOR

Line: 584-00

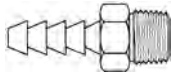

PART NUMBER	SIZE	QTY/BX	LIST PRICE
BLB220A	1/8 X 1/8 (125HB-2-2)	5	
BLB220AC	1/8 X 1/4	5	
BLB54720	3/16 X 1/8 (125HBL-3-2)	5	
BLB220BB	3/16 X 1/4 (125HB-3-4)	5	
BLB52120	1/4 X 1/8 (125HBL-4-2)	5	
BLB52220	1/4 X 1/4 (125HBL-4-4)	5	
BLB220CE	1/4 X 3/8 (125HBL-4-6)	5	
BLB220CF	1/4 X 1/2	5	
BLB220D	5/16 X 1/8 (125HBL52)	5	
BLB220DD	5/16 X 1/4 (125HBL54)	5	
BLB220DE	5/16 X 3/8	5	
BLB220E	3/8 X 1/8 (125HBL-6-2)	5	
BLB52320	3/8 X 1/4 (125HBL-6-4)	5	
BLB52420	3/8 X 3/8 (125HBL-6-6)	5	
BLB220EF	3/8 X 1/2 (125HBL-6-8)	5	
BLB220FC	1/2 X 1/4 (125HBL-8-4)	5	
BLB52520	1/2 X 3/8 (125HBL-8-6)	5	
BLB52620	1/2 X 1/2 (125HBL-8-8)	5	
BLB220FJ	1/2 X 3/4 (125HBL-8-12)	5	
BLB220HE	5/8 X 3/8 (125HBL-10-6)	5	
BLB220H	5/8 X 1/2 (125HBL-10-8)	5	
BLB220HJ	5/8 X 3/4 (125HBL-10-12)	5	
BLB52720	3/4 X 1/2 (125HBL-12-8)	5	
BLB52820	3/4 X 3/4 (125HBL-12-12)	5	
BLB220NJX	1 X 3/4 (125HBL-16-12)	5	
BLB1021616	1 X 1 (125HBL16-16)	1	

## HOSE BARB X FEMALE PIPE THREAD

BRASS PIPE CONNECTOR - H105

Line: 585-00

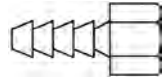

PART NUMBER	SIZE	QTY/BX	LIST PRICE
BMB221A	1/8 X 1/8	5	
BMB221B	3/16 X 1/8	5	
BMB221BB	3/16 X 1/4	5	
BMB221C	1/4 X 1/8 (126HBL-4-2)	5	
BMB221CC	1/4 X 1/4 (126HBL-4-4)	5	
BMB221CE	1/4 X 3/8	5	
BMB221D	5/16 X 1/8	5	
BMB221DD	5/16 X 1/4 (126HBL-5-4)	5	
BMB221EX	3/8 X 1/8	5	
BMB221EE	3/8 X 1/4 (126HBL-6-4)	5	
BMB221EEE	3/8 X 3/8 (126HBL-6-6)	5	
BMB221EF	3/8 X 1/2	5	
BMB221FC	1/2 X 1/4	5	
BMB221F	1/2 X 3/8 (126HBL-8-6)	5	
BMB221FF	1/2 X 1/2	5	
BMB221JJ	3/4 X 3/4	5	

## HOSE BARB X MALE PIPE THREAD - 90° ELBOW

BRASS PIPE CONNECTOR - H057

Line: 586-00

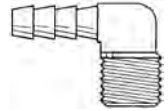

PART NUMBER	SIZE	QTY/BX	LIST PRICE
BNB220LC	1/4 X 1/8 (129HB-4-2)	5	
BNB220LCC	1/4 X 1/4 (129HB-4-4)	5	
BNB220LCE	1/4 X 3/8	5	
BNB220LD	5/16 X 1/8	5	
BNB220CDD	5/16 X 1/4 MPT	5	
BNBHE16A	3/8 X 1/8	5	
BNB220LEE	3/8 X 1/4 (129HB-6-4)	5	
BNB220LEEE	3/8 X 3/8 (129HB-6-6)	5	
BNBHE16D	3/8 X 1/2	5	
BNB220LF	1/2 X 3/8 (129HB-8-6)	5	
BNB220LFF	1/2 X 1/2	5	
BNBHE110C	5/8 X 3/8	5	
BNB229H	5/8 X 1/2	5	
BNB229HE	5/8 X 3/8	5	

### HOSE BARB MALE 45° ELBOW

BRASS PIPE CONNECTOR

Line: 587-00

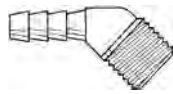

PART NUMBER	SIZE	QTY/BX	LIST PRICE
BPB239C	1/4 X 1/8 (139HB-4-2)	5	
BPB239CC	1/4 X 1/4	5	
BPBHE1455A	5/16 X 1/8	5	
BPBHE1455B	5/16 X 1/4	5	
BPBHE1456A	3/8 X 1/8	5	
BPB239EE	3/8 X 1/4 (139HB-6-4)	5	
BPB239EEE	3/8 X 3/8	5	
BPBHE1458B	1/2 X 1/4	5	
BPB239F	1/2 X 3/8	5	
BPBHE14510C	5/8 X 3/8	5	

### MALE FLARE SAE/JIC FITTING BARB

Line: 588-02

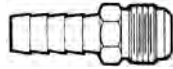

PART NUMBER	SIZE	QTY/BX	LIST PRICE
BMP1420407	1/4 BARB X 1/4 SAE	5	
BMP1420410	1/4 BARB X 3/8 SAE	5	
BMP201BF55	5/16 BARB X 5/16 SAE	5	
BMP1420610	3/8 BARB X 3/8 SAE	5	
BMP1420612	3/8 BARB X 1/2 SAE	5	
BMP1460609	3/8 BARB X 3/8 JIC	5	
BMP201BF88	1/2 BARB X 1/2 SAE	5	

### HOSE BARB FEMALE SAE SWIVEL

H105

Line: 589-00

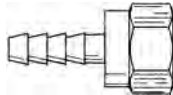

PART NUMBER	SIZE	QTY/BX	LIST PRICE
BSB640CC	1/4 X 1/4 (640CC FE F)	5	
BSB640CE	1/4 X 3/8 (FEM FLAR)	5	
BSB640DDX	5/16 X 5/16 (FEM FLR)	5	
BSBA0626	3/8 X 3/8	5	
BSB209ASF68	3/8 X 1/2	5	
BSB209ASF88	1/2 X 1/2	5	

### HOSE BARB FEMALE BALL SEAT SWIVEL

H105

Line: 590-00

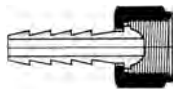

PART NUMBER	SIZE	QTY/BX	LIST PRICE
BTB225A	1/8 X 1/8	5	
BTB209AS3B	3/16 X 1/4	5	
BTB225CC	1/4X1/4 (128HBLV-4-4)	5	
BTB225DD	5/16 X 1/4	5	
BTB225EE	3/8X1/4 (128HBLV-6-4)	5	
BTB225EEE	3/8X3/8 (128HBLV-6-6)	5	
BTB225F	1/2 X 3/8	5	
BTB209AS8D	1/2 X 1/2	5	

### HOSE BARB - UNION MENDER

H105

Line: 591-00



PART NUMBER	SIZE	QTY/BX	LIST PRICE
BUB222B	3/16 X 3/16 (122HB-3)	5	
BUB222C	1/4 X 1/4 (122HBL-4)	5	
BUB222D	5/16 X 5/16 (122HBL-5)	5	
BUB222E	3/8 X 3/8 (122HBL-6)	5	
BUB222F	1/2 X 1/2 (122HBL-8)	5	
BUB222H	5/8 X 5/8	5	
BUB222J	3/4 X 3/4 (122HBL-12)	5	

### HOSE BARB AIR HOSE CLAMPING FURRELS

BRASS

Line: 592-00



PART NUMBER	SIZE	QTY/BX	LIST PRICE
BVB1893X4	1/4 I.D. GPH	10	
BVB2006000	1/4 ID X 19/32 OD	10	
BVB2006255	1/4 ID X 5/8 OD	10	
BVB1893X6	3/8 I.D. GPH	10	
BVB2007180	3/8 ID X 23/32 OD	10	
BVB1893X8	1/2 I.D. GPH	10	
BVB2008750	1/2 ID X 7/8 OD	10	
BVB2009250	1/2 ID X 29/32 OD	10	
BVB1893X12	3/4 I.D. GPH	10	
BVB2009950	3/4 ID X 1 1/16 OD	10	

### HOSE BARB X MALE GARDEN HOSE

GARDEN HOSE FITTING

Line: 592-01

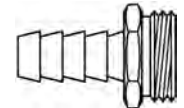

PART NUMBER	SIZE	QTY/BX	LIST PRICE
JCH619FJX	1/2 BARB X 3/4 MGH	5	
JCH619HJX	5/8 BARB X 3/4 MGH	5	
JCH619JJX	3/4 BARB X 3/4 MGH	5	
JCH593-1616	1 BARB X 1 MGH	5	

### MALE GARDEN THREAD TO MALE PIPE THREAD

GARDEN HOSE FITTING

Line: 592-03

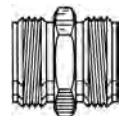

PART NUMBER	SIZE	QTY/BX	LIST PRICE
AEK69GH126	3/4 MGH X 3/8 MPT (69GH12-6)	5	
AEK70GH128	3/4 MGH X 1/2 MPT (70GH12-8)	5	
AEK71GH1212	3/4 MGH X 3/4 MPT (71GH1212)	5	
AEK748JJFX	3/4 MGH X 3/4 MGH X 1/2	5	
AEK75GH12	3/4 MGH X 3/4 MGH (75GH-12)	5	



## GARDEN HOSE FITTING

MALE GARDEN HOSE THREAD TO FEMALE PIPE THREAD

Line: 592-04



PART NUMBER	SIZE	QTY/BX	LIST PRICE
AEL78GH124	3/4MH X 1/4FP (78GH12-4)	5	
AEL79GH126	3/4MH X 3/8FP (79GH12-6)	5	
AEL80GH128	3/4MH X 1/2FP (80GH12-8)	5	
AEL81GH1212	3/4MH X 3/4FP (81GH1212)	5	
AEL81GH1616	1 MH X 1 FP	5	

## GARDEN HOSE FITTING

FEMALE GARDEN HOSE THREAD TO MALE PIPE THREAD

Line: 592-05



PART NUMBER	SIZE	QTY/BX	LIST PRICE
AEM82GH128	3/4FH X 1/2MP (82GH12-8)	5	
AEM83GH1212	3/4FH X 3/4MP (83GH1212)	5	

## GARDEN HOSE FITTING

SWIVEL FEMALE GARDEN HOSE THRD TO MALE PIPE THRD

Line: 592-06

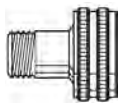

PART NUMBER	SIZE	QTY/BX	LIST PRICE
AEN88GH124	3/4SFH X 1/4MP (88GH124)	5	
AEN89GH126	3/4SFH X 3/8MP (89GH126)	5	

## GARDEN HOSE FITTING

SWIVEL FEMALE GARDEN HOSE THREAD TO HOSE BARB

Line: 592-07

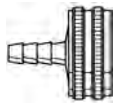

PART NUMBER	SIZE	QTY/BX	LIST PRICE
AEP620HJX	3/4SFH X 5/8 BARB	5	
AEP620JJX	3/4SFH X 3/4 BARB	5	
AEP90GH124	3/4SFH X 1/4 (BAR90GH124)	5	
AEP90GH126	3/4SFH X 3/8 BRB	5	
AEP91GH12H	3/4SFH X 1/2 (BRB91GH128)	5	

## GARDEN HOSE NUT

Line: 592-08

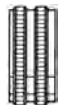

PART NUMBER	SIZE	QTY/BX	LIST PRICE
AER94GH12	3/4FE GH NUT (94GH12)	5	

## GARDEN HOSE CAP

Line: 592-10



PART NUMBER	SIZE	QTY/BX	LIST PRICE
AEV96GH12	3/4FH (96GH-12)	5	

## GARDEN HOSE FITTING

FEMALE GARDEN HOSE THREAD TO FEMALE PIPE THREAD

Line: 592-11



PART NUMBER	SIZE	QTY/BX	LIST PRICE
AEW98GH128	3/4FH X 1/2FP (98GH128)	5	
AEW99GH1212	3/4FH X 3/4FP (99GH1212)	5	

## GARDEN HOSE FITTING

SWIVEL FEMALE GARDEN HOSE TO FEMALE PIPE THREAD

Line: 592-12



PART NUMBER	SIZE	QTY/BX	LIST PRICE
AEX98GHSV128	3/4SFH X 1/2FP	5	
AEX99GHSV1212	3/4 X 3/4	5	

## FEMALE GARDEN HOSE SWIVEL CONNECTOR

Line: 592-13

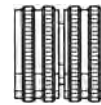

PART NUMBER	SIZE	QTY/BX	LIST PRICE
AEY101GHSV12	3/4FH X 3/4FH	5	

## GARDEN HOSE FITTING

FEMALE GARDEN HOSE THREAD TO MALE SAE FLARE

Line: 592-14

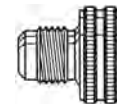

PART NUMBER	SIZE	QTY/BX	LIST PRICE
AEZGHSV612	3/4FH X 3/8M-FL	5	
AEZGHSV812	3/4FH X 1/2M-FL	5	

## GARDEN HOSE SEALING RUBBER WASHER

Line: 592-15



PART NUMBER	SIZE	QTY/BX	LIST PRICE
AFB901GH12	3/4 (901GH-12)	25	

## MALE PIPE HOSE FITTING

247 MEDIUM PRESSURE - REUSABLE

Line: 603-00



PART NUMBER	SIZE	QTY/BX	LIST PRICE
UWA4N102	4 X 1/8 ((20120-2-4)	5	
UWA4N104	4 X 1/4 ((20120-4-4)	5	
UWA5N104	5 X 1/4 (20120-4-5)	5	
UWA6N104	6 X 1/4 (20120-4-6)	5	
UWA6N106	6 X 3/8 (20120-6-6)	5	
UWA8N106	8 X 3/8 (20120-6-8)	5	
UWA8N108	8 X 1/2 (20120-8-8)	5	
UWA10N108	10 X 1/2 (20120-8-10)	5	
UWA10N112	10 X 3/4 (20120-1210)	5	
UWA12N112	12 X 3/4 (20120-1212)	5	

## MALE 45° SAE HOSE FITTING

247 MEDIUM PRESSURE - REUSABLE

Line: 604-00

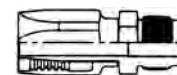

PART NUMBER	SIZE	QTY/BX	LIST PRICE
UXA4N304	4 X 1/4 (20420-4-4)	5	
UXA5N305	5 X 5/16 (20420-5-5)	5	
UXA6N306	6 X 3/8 (20420-6-6)	5	
UXA8N308	8 X 1/2 (20420-8-8)	5	
UXA10N310	10 X 5/8 (20420-1010)	5	
UXA12N312	12 X 3/4 (20420-1212)	5	

### FEMALE 45° SAE SWIVEL

247 MEDIUM PRESSURE - REUSABLE

Line: 605-00

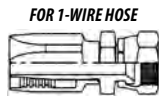

FOR 1-WIRE HOSE

PART NUMBER	SIZE	QTY/BX	LIST PRICE
UYA6N404	6 X 1/4 (20820-4-6)	5	
UYA6N406	6 X 3/8 (20820-6-6)	5	
UYA6N408	6 X 1/2 (20820-8-4)	5	
UYA8N406	8 X 3/8 (20820-6-4)	5	
UYA8N408	8 X 1/2 (20820-8-8)	5	
UYA10N408	10 X 1/2 (20820-8-10)	5	
UYA10N410	10 X 5/8 (20820-1010)	5	
UYA12N412	12 X 3/4 (20820-1212)	5	

### 37° JIC MALE FLARE

247 MEDIUM PTRESSURE - REUSABLE

Line: 606-00

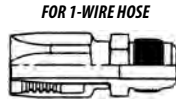

FOR 1-WIRE HOSE

PART NUMBER	SIZE	QTY/BX	LIST PRICE
UZA4N504	4 X 1/4 (20320-4-4)	5	
UZA5N505	5 X 5/16 (20320-5-5)	5	
UZA6N506	6 X 3/8 (20320-6-6)	5	
UZA8N508	8 X 1/2 (20320-8-8)	5	
UZA10N510	10 X 5/8 (20320-1010)	5	
UZA12N512	12 X 3/4 (20320-1212)	5	
UZA16N516	16 X 1 (20320-1616)	5	

### 37° JIC FEMALE SWIVEL

247 MEDIUM PRESSURE - REUSABLE

Line: 607-00

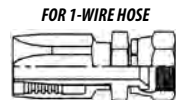

FOR 1-WIRE HOSE

PART NUMBER	SIZE	QTY/BX	LIST PRICE
VAA4N604	4 X 1/4 (20620-4-4)	5	
VAA5N605	5 X 5/16 (20620-5-5)	5	
VAA6N605	6 X 5/16	5	
VAA6N606	6 X 3/8 (20620-6-6)	5	
VAA6N608	6 X 1/2 (20620-8-6)	5	
VAA8N608	8 X 1/2 (20620-8-8)	5	
VAA10N608	10 X 1/2 (20620-8-10)	5	
VAA10N610	10 X 5/8 (20620-1010)	5	
VAA12N412	12 X 3/4 SAE ONLY	5	
VAA12N612	12 X 3/4 (20620-1212)	5	
VAA16N616	16 X 1 (20620-16-16)	5	

### FEMALE JIC 90° LONG ELBOW

247 MEDIUM PRESSURE - REUSABLE

Line: 608-00



FOR 1-WIRE HOSE

PART NUMBER	SIZE	QTY/BX	LIST PRICE
VBA4N644	4 X 1/4 (24120-4-4)	5	
VBA5N645	5 X 5/16 (24120-5-5)	5	
VBA06N466S	6 X 3/8 SAE	5	
VBA6N444	6 X 1/4	5	
VBA6N646	6 X 3/8 (24120-6-6)	5	
VBA8N648	8 X 1/2 (24120-8-8)	5	

### FEMALE SAE 90° LONG ELBOW

247 MEDIUM PRESSURE - REUSABLE

Line: 609-00



FOR 1-WIRE HOSE

PART NUMBER	SIZE	QTY/BX	LIST PRICE
VCA6N446	6 X 3/8 (28120-6-6)	5	

### FEMALE JIC 90° TUBE ELBOW

247 MEDIUM PRESSURE - REUSABLE

Line: 610-00



FOR 1-WIRE HOSE

PART NUMBER	SIZE	QTY/BX	LIST PRICE
VDA4N664	4 X 1/4 (23920-4-4)	5	
VDA5N665	5 X 5/16 (23920-5-5)	5	
VDA6N666	6 X 3/8 (23920-6-6)	5	
VDA8N668	8 X 1/2 (23920-8-8)	5	
VDA10N670	10 X 5/8 (23920-1010)	5	
VDA12N672	12 X 3/4 (23920-12-12)	5	
VDA16N676	16 X 1 (23920-16-16)	5	

### FEMALE JIC 45° TUBE ELBOW

247 MEDIUM PRESSURE - REUSABLE

Line: 612-00



FOR 1-WIRE HOSE

PART NUMBER	SIZE	QTY/BX	LIST PRICE
VFA4N684	4 X 1/4 (23720-4-4)	5	
VFA5N685	5 X 5/16 (23720-5-5)	5	
VFA6N484	6 x 1/4 SAE	5	
VFA6N486S	6 X 3/8 SAE	5	
VFA6N686	6 X 3/8 (23720-6-6)	5	
VFA8N688	8 X 1/2 (23720-8-8)	5	
VFA10N690	10 X 5/8 (23720-10-10)	5	
VFA12N692	12 X 3/4 (23720-12-12)	5	
VFA16N696	16 X 1 (23720-16-16)	5	

### INVERTED MALE NUT SWIVEL

247 MEDIUM PRESSURE - REUSABLE

Line: 615-00



FOR 1-WIRE HOSE

PART NUMBER	SIZE	QTY/BX	LIST PRICE
VJA4NB04	4 X 1/4 (22820-4-4)	5	
VJA5NB05	5 X 5/16 (22820-5-5)	5	
VJA6NB06	6 X 3/8 (22820-6-6)	5	
VJA8NB08	8 X 1/2 (22820-8-8)	5	

### INVERTED MALE NUT 90° ELBOW

247 MEDIUM PRESSURE - REUSABLE

Line: 616-00



FOR 1-WIRE HOSE

PART NUMBER	SIZE	QTY/BX	LIST PRICE
VKA4NE04	4 X 1/4 (26920-4-4)	5	
VKA5NE05	5 X 5/16 (26920-5-5)	5	
VKA6NE04	5 X 1/4	5	
VKA6NE05	6 X 5/16 (26920-5-6)	5	
VKA6NE06	6 X 3/8 (26920-6-6)	5	

## INVERTED MALE 45° ELBOW

247 MEDIUM PRESSURE - REUSABLE

Line: 616-01



FOR 1-WIRE HOSE

PART NUMBER	SIZE	QTY/BX	LIST PRICE
JMS5NE45	5 X 5/16 (26720-5-5)	5	

## HOSE X TUBE FITTING

247 MEDIUM PRESSURE - REUSABLE

Line: 619-00



FOR 1-WIRE HOSE

PART NUMBER	SIZE	QTY/BX	LIST PRICE
VPA4NT54	4 X 1/4	5	
VPA5NT55	5 X 5/16	5	
VPA6NT56	6 X 3/8	5	
VPA8NT58	8 X 1/2	5	
VPA10NT60	10 X 5/8	5	

## AIR BRAKE TUBE FITTING

247 MEDIUM PRESSURE - REUSABLE

Line: 623-00



FOR 1-WIRE HOSE

PART NUMBER	SIZE	QTY/BX	LIST PRICE
VUA8BY56	8 X 3/8	5	
VUA10BY58	10 X 1/2	5	
VUA10BY60	10 X 5/8 (26120-10-10)	5	
VUA12BY62	16 X 1	5	

## MALE PIPE THREAD FITTING

425 HIGH PRESSURE - REUSABLE

Line: 624-00



FOR 2-WIRE HOSE

PART NUMBER	SIZE	QTY/BX	LIST PRICE
VVA4N102	4 X 1/8 (20130-2-4)	5	
VVA4N104	4 X 1/4 (20130-4-4)	5	
VVA4N106	4 X 3/8 (20130-6-4)	5	
VVA6N104	6 X 1/4 (20130-4-6)	5	
VVA6N106	6 X 3/8 (20130-6-6)	5	
VVA8N106	8 X 3/8 (20130-6-8)	5	
VVA8N108	8 X 1/2 (20130-8-8)	5	
VVA8N112	8 X 3/4 (20130-12-8)	5	
VVA12N112	12 X 3/4 (20130-1212)	5	
VVA16N112	16 X 3/4 (20130-12-16)	5	
VVA16N116	16 X 1 (20130-16-16)	2	
VVA20N120	20 X 1 1/4 (20130-2020)	5	
VVA24N124	24 X 1 1/2 (20130-24-24)	5	
VVA32N132	32 X 2 (20130-32-32)	5	

## FEMALE PIPE SWIVEL

425 HIGH PRESSURE - REUSABLE

Line: 624-01



FOR 2-WIRE HOSE

PART NUMBER	SIZE	QTY/BX	LIST PRICE
VWA08N258	8 X 1/2	5	
VWA12N262X	12 X 3/4 (425)	5	

## MALE JIC RIGID PIPE THREAD

425 HIGH PRESSURE - REUSABLE

Line: 625-00



FOR 2-WIRE HOSE

PART NUMBER	SIZE	QTY/BX	LIST PRICE
VXA04N505	4 X 5/16 (20330-5-4)	5	
VXA4N504	4 X 1/4 (20330-4-4)	5	
VXA4N506	4 X 3/8 (20330-6-4)	5	
VXA6N506	6 X 3/8 (20330-6-6)	5	
VXA6N508	6 X 1/2 (20330-8-6)	5	
VXA8N508	8 X 1/2 (20330-8-8)	5	
VXA8N510	8 X 5/8 (20330-10-8)	5	
VXA12N512	12 X 3/4 (20330-1212)	5	
VXA12N514	12 X 7/8 (20330-14-12)	5	
VXA16N516	16 X 1 (20330-16-16)	5	
VXA20N520	20 X 1 1/4 (20330-20-20)	5	

## JIC FEMALE SWIVEL

425 HIGH PRESSURE - REUSABLE

Line: 626-00

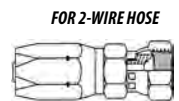

FOR 2-WIRE HOSE

PART NUMBER	SIZE	QTY/BX	LIST PRICE
VYA04N604	4 X 1/4 (20630-4-4)	5	
VYA04N605	4 X 5/16 (20630-5-4)	5	
VYA04N606	4 X 3/8 (20630-6-4)	5	
VYA4N605	4 X 5/16 (20630-5-4)	5	
VYA6N606	6 X 3/8 (20630-6-6)	5	
VYA6N608	6 X 1/2 (20630-8-6)	5	
VYA8N608	8 X 1/2 (20630-8-8)	5	
VYA8N610	8 X 5/8 (20630-10-8)	5	
VYA12N610	12 X 5/8 (20630-1012)	5	
VYA12N612	12 X 3/4 (20630-1212)	5	
VYA12N614	12 X 7/8 (20630-14-12)	5	
VYA16N616	16 X 1 (20630-16-16)	5	
VYA20N620	20 X 1 1/4 (20630-20-20)	5	
VYA24N624	24 X 1 1/2 (20630-24-24)	5	
VYA32N632	32 X 2 (20630-32-32)	5	

## SAE FEMALE SWIVEL

425 HIGH PRESSURE - REUSABLE

Line: 627-00

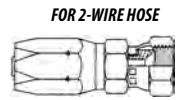

FOR 2-WIRE HOSE

PART NUMBER	SIZE	QTY/BX	LIST PRICE
VZA6N406	6 X 3/8 (20830-6-6)	5	

## JIC 90° SWIVEL LONG DROP ELBOW

425 HIGH PRESSURE - REUSABLE

Line: 628-00



FOR 2-WIRE HOSE

PART NUMBER	SIZE	QTY/BX	LIST PRICE
WAA6N646	6 X 3/8 (24130-6-6)	5	
WAA8N648	8 X 1/2 (24130-8-8)	5	
WAA8N650	8 X 5/8 (24130-10-8)	5	
WAA12N652	12 X 3/4 (24130-12-12)	5	
WAA16N656	16 X 1 (24130-16-16)	5	

### JIC 90° SWIVEL TUBE ELBOW

425 HIGH PRESSURE - REUSABLE

Line: 629-00

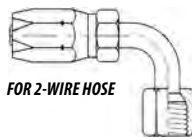

FOR 2-WIRE HOSE

PART NUMBER	SIZE	QTY/BX	LIST PRICE
WBA04N664	4 X 1/4 (23930-4-4)	5	
WBA6N666	6 X 3/8 (23930-6-6)	5	
WBA08N668	8 X 1/2 (23930-8-8)	5	
WBA08N670	8 X 5/8 (23930-10-8)	5	
WBA12N672	12 X 3/4 (23930-12-12)	5	
WBA16N676	16 X 1 (23930-16-16)	5	

### JIC 45° SWIVEL TUBE ELBOW

425 HIGH PRESSURE - REUSABLE

Line: 629-01



FOR 2-WIRE HOSE

PART NUMBER	SIZE	QTY/BX	LIST PRICE
JNS04N684	4 X 1/4 (23730-4-4)	5	
JNS06N686	6 X 3/8 (23730-6-6)	5	
JNS08N688	8 X 1/2 (23730-8-8)	5	
JNS08N690	8 X 5/8 (23730-10-8)	5	
JNS12N692	12 X 3/4 (23730-12-12)	5	
JNS16N696	16 X 1 (23730-16-16)	5	

### MALE CONNECTOR O-RING STRAIGHT THREAD

425 HIGH PRESSURE - REUSABLE

Line: 629-02



FOR 2-WIRE HOSE

PART NUMBER	SIZE	QTY/BX	LIST PRICE
JPS04NP04	4 X 1/4 (20530-4-4)	5	
JPS04NP06	4 X 3/8 (20530-6-4)	5	
JPS06NP06	6 X 3/8 (20530-6-6)	5	
JPS06NP08	6 X 1/2 (20530-8-8)	5	
JPS08NP08	8 X 1/2 (20530-8-8)	5	
JPS08NP10	8 X 5/8 (20530-10-8)	5	
JPS08NP12	8 X 3/4 (20530-12-8)	5	
JPS12NP12	12 X 3/4 (20530-1212)	5	

### CLAMP TYPE MALE PIPE FITTING

425 HIGH PRESSURE

Line: 630-00

FOR 2-WIRE HOSE

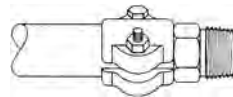

PART NUMBER	SIZE	QTY/BX	LIST PRICE
WDAK12N112	12 X 3/4 (0188-12-12)	5	
WDAK16N116	16 X 1 (0188-16-16)	5	
WDAK20N120	20 X 1 1/4 (0188-2020)	1	
WDAK24N124	24 X 1 1/2 (0188-2424)	5	
WDAK32N132	32 X 2 (0188-32-32)	1	

### CLAMP TYPE STEEL HOSE ENDS

HIGH PRESSURE

Line: 630-02

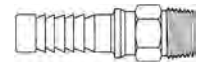

PART NUMBER	SIZE	QTY/BX	LIST PRICE
JVS1KE04N104	4 X 1/4 MPT	5	
JVS1KE06N106	6 X 3/8 MPT	5	
JVS1KE08N108	8 X 1/2 MPT	5	
JVS1KE12N112	12 X 3/4 MPT	5	
JVS1KE16N116	16 X 1 MPT	5	
JVS1KE20N120	20 X 1 1/4	5	
JVS1KE24N124	24 X 1 1/2	5	
JVS1KE32N132	32 X 2	5	

### CLAMP COLLAR FOR K SERIES

HIGH PRESSURE

Line: 630-03



PART NUMBER	SIZE	QTY/BX	LIST PRICE
AXZK08	1/2 ID CLAMP ASSM	1	
AXZK12	3/4 ID CLAMP ASSM	1	
AXZK16	1 ID CLAMP ASSM	1	

### HOSE BARB-MALE PIPE THREAD ADAPTER

GALVANIZED STEEL

Line: 630-10

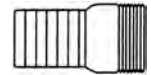

PART NUMBER	SIZE	QTY/BX	LIST PRICE
AXMMAS2	1/2 MPT X 1/2 BARB	1	
AXMMAS3	3/4 MPT X 3/4 BARB	1	
AXMMAS4	1MPT X 1 BARB	1	
AXMMAS5	1 1/4MPT X 1 1/4 BARB	1	
AXMMAS6	1 1/2MPT X 1 1/2 BARB	1	
AXMMAS8	2 MPT X 2 BARB	1	
AXMMAS12	3MPT X 3 BARB	1	
AXMMAS16	4 MPT X 4 BARB	1	
AXMMAS20	5 MPT X 5 BARB	1	
AXMCN600	6 MPT X 6 BARB	1	

### HOSE BARB STEEL UNION COUPLING

GALVANIZED STEEL

Line: 630-11

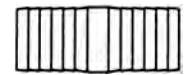

PART NUMBER	SIZE	QTY/BX	LIST PRICE
AXNCS2	1/2 BARB	4	
AXNCS3	3/4 BARB	2	
AXNCS4	1 BARB	2	
AXNCS5	1 1/4 BARB	1	
AXNCS6	1 1/2 BARB	1	
AXNCS8	2 BARB	1	
AXNHM300	3 BARB	1	
AXNHM400	4 BARB	1	
AXNHM500	5 BARB	1	
AXNHM600	6 BARB	1	

## MALE CAM/FEMALE PIPE THREAD

CAM-GROOVE COUPLING-ALUMINUM

Line: 630-20

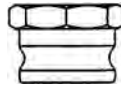

PART NUMBER	SIZE	QTY/BX	LIST PRICE
AYJA075A	3/4	1	
AYJA100A	1	1	
AYJA125A	1 1/4	1	
AYJA150A	1 1/2	1	
AYJA200A	2	1	
AYJA250A	2 1/2	1	
AYJA300A	3	1	
AYJA400A	4	1	

## FEMALE CAM/MALE PIPE THREAD

CAM-GROOVE COUPLING-ALUMINUM

Line: 630-21



PART NUMBER	SIZE	QTY/BX	LIST PRICE
AYKB075A	3/4	1	
AYKB100A	1	1	
AYKB125A	1 1/4	1	
AYKB150A	1 1/2	1	
AYKB200A	2	1	
AYKB250A	2 1/2	1	
AYKB300A	3	1	
AYKB400A	4	1	

## FEMALE CAM/BARB SHANK

CAM-GROOVE COUPLING-ALUMINUM

Line: 630-22

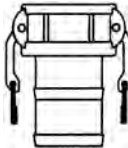

PART NUMBER	SIZE	QTY/BX	LIST PRICE
AYLC075A	3/4	1	
AYLC100A	1	1	
AYLC125A	1 1/4	1	
AYLC150A	1 1/2	1	
AYLC200A	2	1	
AYLC250A	2 1/2	1	
AYLC300A	3	1	
AYLC400A	4	1	

## FEMALE CAM/FEMALE PIPE THREAD

CAM-GROOVE COUPLING-ALUMINUM

Line: 630-23



PART NUMBER	SIZE	QTY/BX	LIST PRICE
AYMD075A	3/4	1	
AYMD100A	1	1	
AYMD125A	1 1/4	1	
AYMD150A	1 1/2	1	
AYMD200A	2	1	
AYMD250A	2 1/2	1	
AYMD300A	3	1	
AYMD400A	4	1	
AYMD600A	6	1	

## MALE CAM/BARB SHANK

CAM-GROOVE COUPLING-ALUMINUM

Line: 630-24



PART NUMBER	SIZE	QTY/BX	LIST PRICE
AYNE075A	3/4	1	
AYNE100A	1	1	
AYNE125A	1 1/4	1	
AYNE150A	1 1/2	1	
AYNE200A	2	1	
AYNE250A	2 1/2	1	
AYNE300A	3	1	
AYNE400A	4	1	
AYNE600A	6	1	

## MALE CAM/MALE PIPE THREAD

CAM-GROOVE COUPLING-ALUMINUM

Line: 630-25

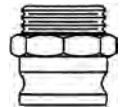

PART NUMBER	SIZE	QTY/BX	LIST PRICE
AYPF075A	3/4	1	
AYPF100A	1	1	
AYPF125A	1 1/4	1	
AYPF150A	1 1/2	1	
AYPF200A	2	1	
AYPF250A	2 1/2	1	
AYPF300A	3	1	
AYPF400A	4	1	
AYPF600A	6	1	



CALL - 1 (800) 723-2826

### MALE CAMLOCK PLUG

CAM-GROOVE COUPLING-ALUMINUM

Line: 630-26

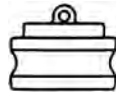

PART NUMBER	SIZE	QTY/BX	LIST PRICE
BALDP075A	3/4	1	
BALDP100A	1	1	
BALDP125A	1 1/4	1	
BALDP150A	1 1/2	1	
BALDP200A	2	1	
BALDP250A	2 1/2	1	
BALDP300A	3	1	
BALDP400A	4	1	
BALDP600A	6	1	

### FEMALE CAM CAP

CAM-GROOVE COUPLING-ALUMINUM

Line: 630-27

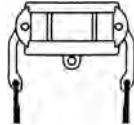

PART NUMBER	SIZE	QTY/BX	LIST PRICE
BAMDC075A	3/4	1	
BAMDC100A	1	1	
BAMDC125A	1 1/4	1	
BAMDC150A	1 1/2	1	
BAMDC200A	2	1	
BAMDC250A	2 1/2	1	
BAMDC300A	3	1	
BAMDC400A	4	1	
BAMDC600A	6	1	

### MALE CAM UNION

CAM-GROOVE COUPLING-ALUMINUM

Line: 630-28



PART NUMBER	SIZE	QTY/BX	LIST PRICE
BHVAA1515A	1 1/2	1	
BHVAA2020A	2	1	
BHVAA3030A	3	1	
BHVAA3030SS	3 S/S	1	
BHVAA4040A	4	1	



CALL - 1 (800) 723-2826

### HANDLE CAM ASSEMBLY & GASKETS

CAM-LOK FITTING PARTS

Line: 630-29



PART NUMBER	SIZE	QTY/BX	LIST PRICE
BHW075HA	1/2-3/4 HAN/PIN S/S	2	
BHW125BN	1 1/4 GASKETS	10	
BHW125HA	1 1/4-2 1/2 H&P BRASS	2	
BHW150BN	1 1/2 GASKETS	10	
BHW150TSE	1 1/2 GSKT TEF/ENC SIL	4	
BHW200HASS	1 1/4-2 1/2 H&P S/S	2	
BHW250BN	2 1/2 GASKETS	5	
BHW250HA	3-5 HDL/PIN BRASS	2	
BHW250PRSS	1/2-2 1/2 SS PULL RG	10	
BHW400HA	3- 5 HNDL/PIN S/S	2	
BHW600HA	6-8HDL/PIN BRASS	2	
BHW075BN	3/4 GASKETS	10	
BHW100BN	1 GASKETS	10	
BHW100HA	1HANDLE/PIN S/S	2	
BHW200BN	2 GASKETS	10	
BHW300BN	3 GASKETS	5	
BHW400BN	4 GASKETS	5	
BHW600BN	6 GASKETS	5	

### JIC 3 PIECE NUT

STEEL HYDRAULIC FITTING

Line: 647-00



PART NUMBER	SIZE	QTY/BX	LIST PRICE
WFAC5105X2	1/8 (06B-2)	5	
WFAC5105X3	3/16 (06B-3)	5	
WFAC5105X4	1/4 (06B-4)	5	
WFAC5105X5	5/16 (06B-5)	5	
WFAC5105X6	3/8 (06B-6)	5	
WFAC5105X8	1/2 (06B-8)	5	
WFAC5105X10	5/8 (06B-10)	5	
WFAC5105X12	3/4 (06B-12)	5	
WFAC5105X14	7/8 (06B-14)	5	
WFAC5105X16	1 (06B-16)	5	
WFAC5105X20	1 1/4 (06B-20)	5	
WFAC5105X24	1 1/2 (06B-24)	5	
WFAC5105X32	2 (06B-32)	5	

## JIC 2 PIECE NUT

STEEL HYDRAULIC FITTING

Line: 648-00

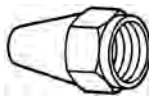

PART NUMBER	SIZE	QTY/BX	LIST PRICE
WGAC5115X4	1/4	5	
WGAC5115X5	5/16	5	
WGAC5115X6	3/8	5	
WGAC5115X8	1/2	5	
WGAC5115X10	5/8	5	

## JIC SLEEVE

STEEL HYDRAULIC FITTING

Line: 649-00



PART NUMBER	SIZE	QTY/BX	LIST PRICE
WHAC5165X2	1/8 (06S-2)	5	
WHAC5165X3	3/16 (06S-3)	5	
WHAC5165X4	1/4 (06S-4)	5	
WHAC5165X5	5/16 (06S-5)	5	
WHAC5165X6	3/8 (06S-6)	5	
WHAC5165610MM	3/8 JIC X 10MM TUBE	5	
WHAC5165X8	1/2 (06S-8)	5	
WHAC5165812MM	1/2 JIC X 12MM TUBE	5	
WHAC5165X10	5/8 (06S-10)	5	
WHAC51651014M	5/8 JIC X 14MM TUBE	5	
WHAC5165X12	3/4 (06S-12)	5	
WHAC5165X14	7/8 (06S-14)	5	
WHAC5165X16	1 (06S-16)	5	
WHAC5165X20	1 1/4 (06S-20)	5	
WHAC5165X24	1 1/2 (06S-24)	5	
WHAC5165X32	2 (06S-32)	5	

## JIC CAP

STEEL HYDRAULIC FITTING

Line: 650-00



PART NUMBER	SIZE	QTY/BX	LIST PRICE
WJAC5129X2	1/8 (06CP-2)	5	
WJAC5129X3	3/16 (06CP-3)	5	
WJAC5129X4	1/4 (06CP-4)	5	
WJAC5129X5	5/16 (06CP-5)	5	
WJAC5129X6	3/8 (06CP-6)	5	
WJAC5129X8	1/2 (06CP-8)	5	
WJAC5129X10	5/8 (06CP-10)	5	
WJAC5129X12	3/4 (06CP-12)	5	
WJAC5129X14	7/8 (06CP-14)	5	
WJAC5129X16	1 (06CP-16)	5	
WJAC5129X20	1 1/4 (06CP-20)	5	
WJAC5129X24	1 1/2 (06CP-24)	1	

## JIC PLUG

STEEL HYDRAULIC FITTING

Line: 652-00



PART NUMBER	SIZE	QTY/BX	LIST PRICE
WLAC5229X3	3/16 (03CP-3)	5	
WLAC5229X4	1/4 (03CP-4)	5	
WLAC5229X5	5/16 (03CP-5)	5	
WLAC5229X6	3/8 (03CP-6)	5	
WLAC5229X8	1/2 (03CP-8)	5	
WLAC5229X10	5/8 (03CP-10)	5	
WLAC5229X12	3/4 (03CP-12)	5	
WLAC5229X14	7/8 (03CP-14)	5	
WLAC5229X16	1 (03CP-16)	5	
WLAC5229X20	1 1/4 (03CP-20)	5	
WLAC5229X24	1 1/2 (03CP-24)	1	

## JIC STANDARD HEX UNION

STEEL HYDRAULIC FITTING

Line: 653-00

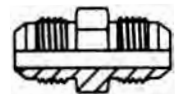

PART NUMBER	SIZE	QTY/BX	LIST PRICE
WMAC5305X2	1/8	5	
WMAC5305X3	3/16	5	
WMAC5305X4	1/4	5	
WMA0303X4X6	1/4 X 3/8 REDUCING	5	
WMAC5305X5	5/16	5	
WMAC5305X6	3/8	5	
WMA0303X6X8	3/8 X 1/2 REDUCING	5	
WMAC5305X8	1/2	5	
WMA0303X8X10	1/2 X 5/8 REDUCING	5	
WMA0303X8X12	1/2 X 3/4 REDUCING	5	
WMAC5305X10	5/8	5	
WMA0303X10X12	5/8 X 3/4 REDUCING	2	
WMAC5305X12	3/4	5	
WMAC5305X14	7/8	5	
WMAC5305X16	1	5	
WMAC5305X20	1 1/4	1	
WMAC5305X24	1 1/2	1	
WMAC5305X32	2	1	

### JIC LARGE HEX UNION

STEEL HYDRAULIC FITTING

Line: 654-00



PART NUMBER	SIZE	QTY/BX	LIST PRICE
WNAC5306X4	1/4	5	
WNAC5306X5	5/16	5	
WNAC5306X6	3/8	5	
WNAC5306X8	1/2	5	
WNAC5306X10	5/8	1	
WNAC5306X12	3/4	1	
WNAC5306X16	1	1	
WNAC5306X20	1 1/4	1	
WNAC5306X24	1 1/2	1	

### JIC BULKHEAD UNION

STEEL HYDRAULIC FITTING

Line: 655-00

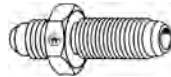

PART NUMBER	SIZE	QTY/BX	LIST PRICE
WPAC5325X3	3/16 (0353-3-3)	5	
WPAC5325X4	1/4 (0353-4-4)	5	
WPAC5325X5	5/16 (0353-5-5)	5	
WPAC5325X6	3/8 (0353-6-6)	5	
WPAC5325X8	1/2 (0353-8-8)	5	
WPAC5325X10	5/8 (0353-10-10)	5	
WPAC5325X12	3/4 (0353-12-12)	1	
WPAC5325X14	7/8 (0353-14-14)	1	
WPAC5325X16	1 (0353-16-16)	1	
WPAC5325X20	1 1/4 (0353-20-20)	1	

### JIC BULKHEAD UNION 45° ELBOW

STEEL HYDRAULIC FITTING

Line: 656-00

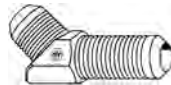

PART NUMBER	SIZE	QTY/BX	LIST PRICE
WRAC5375X4	1/4 (4WN TX) NO NUT	5	
WRAC5375X8	1/2 (8WN TX) NO NUT	5	

### JIC 90° UNION ELBOW

STEEL HYDRAULIC FITTING

Line: 657-00



PART NUMBER	SIZE	QTY/BX	LIST PRICE
WSAC5505X2	1/8 (2303-2-2)	5	
WSAC5505X3	3/16 (2303-3-3)	5	
WSAC5505X4	1/4 (2303-4-4)	5	
WSAC5505X5	5/16 (2303-5-5)	5	
WSAC5505X6	3/8 (2303-6-6)	5	
WSAC5505X8	1/2 (2303-8-8)	5	
WSAC5505X10	5/8 (2303-10-10)	1	
WSAC5505X108	5/8 X 1/2 REDUCING	5	
WSAC5505X12	3/4 12 ETX-S)	1	
WSAC5505X14	7/8 (2303-14-14)	1	
WSAC5505X16	1 (2303-16-16)	1	
WSAC5505X20	1 1/4 (2303-20-20)	1	
WSAC5505X24	1 1/2 (2303-24-24)	1	

### JIC BULKHEAD 90° UNION ELBOW

STEEL HYDRAULIC FITTING

Line: 657-05

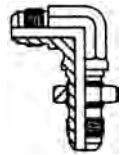

PART NUMBER	SIZE	QTY/BX	LIST PRICE
WTAC5525X4X	1/4 (2353-4-4)	5	
WTAC5525X5X	5/16 (2353-5-5)	5	
WTAC5525X6X	3/8 6 WETX-WLN-S	5	
WTAC5525X8	1/2 (2353-8-8)	5	
WTAC5525X10	5/8 (2353-10-10)	1	
WTAC5525X12	3/4 (2353-12-12)	1	
WTAC5525X16	1 (2353-16-16)	1	
WTAC5525X20	1 1/4 (2353-20-20)	1	

### JIC UNION TEE

STEEL HYDRAULIC FITTING

Line: 658-00

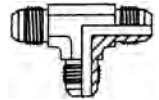

PART NUMBER	SIZE	QTY/BX	LIST PRICE
WUAC5705X2	1/8 (033T-2-2)	5	
WUAC5705X3	3/16 (033T-3-3)	5	
WUAC5705X4	1/4 (033T-4-4)	5	
WUAC5705X5	5/16 (033T-5-5)	5	
WUAC5705X6	3/8 (033T-6-6)	5	
WUAC5705X8	1/2 (033T-8-8)	5	
WUAC5705X10	5/8 (033T-10-10)	1	
WUAC5705X12	3/4 (033T-12-12)	1	
WUAC5705X14	7/8 (033T-14-14)	1	
WUAC5705X16	1 (033T-16-16)	1	
WUAC5705X20	1 1/4 (033T-20-20)	1	
WUAC5705X24	1 1/2 (033T-24-24)	1	



## JIC BULKHEAD BRANCH TEE

STEEL HYDRAULIC FITTING

Line: 659-00



PART NUMBER	SIZE	QTY/BX	LIST PRICE
WVAC5725X4	1/4 (543T-4-4)	5	
WVAC5725X6	3/8 (543T-6-6)	5	
WVAC5725X8	1/2 (543T-8-8)	2	
WVAC5725X10	5/8 (543T-10-10)	1	
WVAC5725X12	3/4 (543T-12-12)	1	

## JIC BULKHEAD RUN TEE

STEEL HYDRAULIC FITTING

Line: 660-00

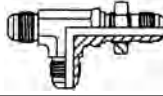

PART NUMBER	SIZE	QTY/BX	LIST PRICE
WWAC5726X4	1/4 (533T-4-4)	5	
WWAC5726X6	3/8 (533T-6-6)	5	
WWAC5726X8	1/2 (533T-8-8)	5	
WWAC5726X10	5/8 (533T-10-10)	1	
WWAC5726X12	3/4 (533T-12-12)	1	
WWAC5726X16	1 (533T-16-16)	1	

## JIC FEMALE SWIVEL/MALE JIC REDUCER

STEEL HYDRAULIC FITTING

Line: 660-02

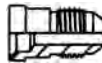

PART NUMBER	SIZE	QTY/BX	LIST PRICE
AXB603X6X5	3/8 FX 5/16 M	5	
AXB603X6X8	3/8 FX 1/2 M	5	
AXB603X64	3/8 FX 1/4 M	5	
AXB603X812	1/2 FX 3/4 M	2	
AXB603X84	1/2 FX 1/4 M	5	
AXB603X84C	1/2 FX 1/4 M	5	
AXB603X86	1/2 FX 3/8 M	5	
AXB603X1012	5/8 FX 3/4 M	5	
AXB603X104	5/8 FX 1/4 M	5	
AXB603X106	5/8 FX 3/8 M	5	
AXB603X108	5/8 FX 1/2 M	5	
AXB603X1210	3/4 FX 5/8 M	5	
AXB603X124	3/4 FX 1/4 M	5	
AXB603X126	3/4 FX 3/8 M	5	
AXB603X128	3/4 FX 1/2 M	5	
AXB603X1410	7/8 FX 5/8 M	4	
AXB603X1412	7/8 FX 3/4 M	4	
AXB603X146	7/8 FX 3/8 M	4	
AXB603X168	1 FX 1/2 M	2	
AXB603X1612	1 FX 3/4 M	2	
AXB603X1614	1 FX 7/8 M	2	
AXB603X2016	1 1/4 FX 1 M	2	
AXB603X2420	1 1/2 FX 1 1/4 M	2	

## JIC MALE/FEMALE SWIVEL 45° ELBOW

STEEL HYDRAULIC FITTING

Line: 661-00



PART NUMBER	SIZE	QTY/BX	LIST PRICE
WYAC5356X4	1/4 (3703-4-4)	5	
WYAC5356X5	5/16 (3703-5-5)	5	
WYAC5356X6	3/8 (3703-6-6)	5	
WYAC5356X8	1/2 (3703-8-8)	5	
WYAC5356X10	5/8 (3703-10-10)	1	
WYAC5356X12	3/4 (3703-12-12)	1	
WYAC5356X14	7/8 (3703-14-14)	1	
WYAC5356X16	1 (3703-16-16)	1	
WYAC5356X20	1 1/4 (3703-20-20)	1	
WYAC5356X24	1 1/2 (3703-24-24)	1	
WYAC5356X32	2 (3703-32-32)	1	

## JIC MALE/FEMALE SWIVEL 90° ELBOW

STEEL HYDRAULIC FITTING

Line: 662-00



PART NUMBER	SIZE	QTY/BX	LIST PRICE
WZAC5506X3	3/16 (3903-3-3)	5	
WZAC5506X4	1/4 (3903-4-4)	5	
WZAC5506X5	5/16 (3903-5-5)	5	
WZAC5506X6	3/8 (3903-6-6)	5	
WZAC5506X8	1/2 (3903-8-8)	5	
WZAC5506X10	5/8 (3903-10-10)	1	
WZAC5506X12	3/4 (3903-12-12)	1	
WZAC5506X14X	7/8 (3903-14-14)	1	
WZAC5506X16	1 (3903-16-16)	1	
WZAC5506X20	1 1/4 (3903-20-20)	1	
WZAC5506X24	1 1/2 (3903-24-24)	1	
WZAC5506X32	2 (3903-32-32)	1	

## JIC SWIVEL NUT MALE RUN TEE

STEEL HYDRAULIC FITTING

Line: 663-00

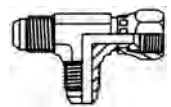

PART NUMBER	SIZE	QTY/BX	LIST PRICE
XAAC5706X4	1/4 (063T-4-4)	5	
XAAC5706X5	5/16 (063T-5-5)	5	
XAAC5706X6	3/8 (063T-6-6)	5	
XAAC5706X8	1/2 (063T-8-8)	5	
XAAC5706X10	5/8 (063T-10-10)	1	
XAAC5706X12	3/4 (063T-12-12)	1	
XAAC5706X16	1 (063T-16-16)	1	
XAAC5706X20	1 1/4 (063T-20-20)	1	
XAAC5706X32	2 (063T-32-32)	1	

### JIC SWIVEL NUT MALE BRANCH TEE

STEEL HYDRAULIC FITTING

Line: 664-00



PART NUMBER	SIZE	QTY/BX	LIST PRICE
<b>XBAC5707X4</b>	1/4 (393T-4-4)	5	
<b>XBAC5707X5</b>	5/16 (393T-5-5)	5	
<b>XBAC5707X6</b>	3/8 6 S6X-5)	5	
<b>XBAC5707X8</b>	1/2 8 S6X-5)	5	
<b>XBAC5707X10</b>	5/8 (393T-10-10)	1	
<b>XBAC5707X12</b>	3/4 (393T-12-12)	1	
<b>XBAC5707X16</b>	1 (393T-16-16)	1	
<b>XBAC5707X20</b>	1 1/4 (393T-20-20)	1	
<b>XBAC5707X24</b>	1 1/2 (393T-24-24)	1	
<b>XBAC5707X32</b>	2 (393T-32-32)	1	

### JIC BULKHEAD CLAMPING NUT

STEEL HYDRAULIC FITTING

Line: 665-00



PART NUMBER	SIZE	QTY/BX	LIST PRICE
<b>XCAC5924X2</b>	1/8 (53N-2)	5	
<b>XCAC5924X3</b>	3/16 (53N-3)	5	
<b>XCAC5924X4</b>	1/4 (53N-4)	5	
<b>XCAC5924X5</b>	5/16 (53N-5)	5	
<b>XCAC5924X6</b>	3/8 (53N-6)	5	
<b>XCAC5924X8</b>	1/2 (53N-8)	5	
<b>XCAC5924X10</b>	5/8 (53N-10)	1	
<b>XCAC5924X12</b>	3/4 (53N-12)	1	
<b>XCAC5924X14</b>	7/8 (53N-14)	1	
<b>XCAC5924X16</b>	1 (53N-16)	1	
<b>XCAC5924X20</b>	1 1/4 (53N-20)	1	
<b>XCAC5924X24</b>	1 1/2 (53N-24)	1	
<b>XCAC5924X32</b>	2 (53N-32)	1	

### JIC MALE CONNECTOR

STEEL HYDRAULIC FITTING

Line: 666-00

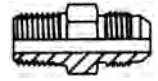

PART NUMBER	SIZE	QTY/BX	LIST PRICE
<b>XDAC5205X2</b>	1/8 X 1/8 (0103-2-2)	5	
<b>XDAC5205X3</b>	3/16 X 1/8 (0103-2-3)	5	
<b>XDAC5205X4</b>	1/4 X 1/8 (0103-2-4)	5	
<b>XDAC5205X44</b>	1/4 X 1/4 (0103-4-4)	5	
<b>XDAC5205X46</b>	1/4 X 3/8	5	
<b>XDAC5205X48</b>	1/4 X 1/2 (0103-8-4)	5	
<b>XDAC5205X5</b>	5/16 X 1/8 (0103-2-5)	5	
<b>XDAC5205X54</b>	5/16 X 1/4 (0103-4-5)	5	
<b>XDAC5205X56</b>	5/16 X 3/8	5	
<b>XDAC5205X62</b>	3/8 X 1/8 (0103-2-6)	5	
<b>XDAC5205X6</b>	3/8 X 1/4 (0103-4-6)	5	
<b>XDAC5205X66</b>	3/8 X 3/8 (0103-6-6)	5	
<b>XDAC5205X68</b>	3/8 X 1/2 (0103-8-6)	5	
<b>XDAC5205X84</b>	1/2 X 1/4 (0103-4-8)	5	
<b>XDAC5205X8</b>	1/2 X 3/8 (0103-6-8)	5	
<b>XDAC5205X88</b>	1/2 X 1/2 (0103-8-8)	5	
<b>XDA5217X8X8</b>	1/2 X 1/2 S/S	1	
<b>XDAC5205X812</b>	1/2 X 3/4 (0103-12-8)	5	
<b>XDAC5205X106</b>	5/8 X 3/8 (0103-6-10)	1	
<b>XDAC5205X10</b>	5/8 X 1/2 (0103-8-10)	1	
<b>XDAC52051012</b>	5/8 X 3/4 (0103-12-10)	1	
<b>XDAC5205X128</b>	3/4 X 1/2 (0103-8-12)	1	
<b>XDAC5205X12</b>	3/4 X 3/4 (0103-12-12)	1	
<b>XDA52171212SS</b>	3/4 X 3/4 S/S	1	
<b>XDAC52051216</b>	3/4 X 1 (0103-16-12)	1	
<b>XDAC5205X14</b>	7/8 X 3/4 (0103-12-14)	1	
<b>XDAC52051612</b>	1 X 3/4 (0103-12-16)	1	
<b>XDAC5205X16</b>	1 X 1 (0103-16-16)	1	
<b>XDAC52052016</b>	1 1/4 X 1 (0103-16-20)	1	
<b>XDAC5205X20</b>	1 1/4 X 1 1/4 (0103-20-20)	1	
<b>XDAC52052420</b>	1 1/2 X 1 1/4 (0103-20-24)	1	
<b>XDAC5205X24</b>	1 1/2 X 1 1/2 (0103-24-24)	1	
<b>XDAC5205X32</b>	2 X 2 (0103-32-32)	1	

## JIC FEMALE CONNECTOR

STEEL HYDRAULIC FITTING

Line: 667-00

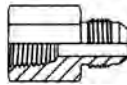

PART NUMBER	SIZE	QTY/BX	LIST PRICE
XEAC5255X2	1/8 X 1/8 (0203-2-2)	5	
XEAC5255X3	3/16 X 1/8 (0203-3-3)	5	
XEAC5255X4	1/4 X 1/8 (0203-2-4)	5	
XEAC5255X44	1/4 X 1/4 (0203-4-4)	5	
XEAC5255X5	5/16 X 1/8 (0203-2-5)	5	
XEAC5255X54	5/16 X 1/4 (0203-4-5)	5	
XEAC5255X6	3/8 X 1/4 (0203-4-6)	5	
XEAC5255X66	3/8 X 3/8 (0203-6-6)	5	
XEAC5255X8	1/2 X 3/8 (0203-6-8)	5	
XEAC5255X88	1/2 X 1/2 (0203-8-8)	5	
XEAC5255X10	5/8 X 1/2 (0203-8-10)	1	
XEAC5255X12	3/4 X 3/4 (0203-12-12)	1	
XEAC5255X128	3/4 X 1/2 (0203-8-12)	1	
XEAC5255X14	7/8 X 3/4 (0203-12-14)	1	
XEAC5255X16	1 X 1 (0203-16-16)	1	
XEAC5255X20	1 1/4 X 1 1/4 (0203-20-20)	1	
XEAC5255X24	1 1/2 X 1 1/2 (0203-24-24)	1	
XEAC5255X32	2 X 2 (0203-32-32)	1	

## JIC 45° MALE ELBOW

STEEL HYDRAULIC FITTING

Line: 668-00

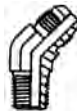

PART NUMBER	SIZE	QTY/BX	LIST PRICE
XFAC5355X2	1/8 X 1/8 (3103-2-2)	5	
XFAC5355X3	3/16 X 1/8 (3103-2-3)	5	
XFAC5355X4	1/4 X 1/8 (3103-2-4)	5	
XFAC5355X44	1/4 X 1/4 (3103-4-4)	5	
XFAC5355X5	5/16 X 1/8 (3103-2-5)	5	
XFAC5355X54	5/16 X 1/4 (3103-4-5)	5	
XFAC5355X6	3/8 X 1/4 (3103-4-6)	5	
XFAC5355X62	3/8 X 1/8 (3103-2-6)	5	
XFAC5355X66	3/8 X 3/8 (3103-6-6)	5	
XFAC5355X68	3/8 X 1/2 (3103-8-6)	5	
XFAC5355X8	1/2 X 3/8 (3103-6-8)	5	
XFAC5355X84	1/2 X 1/4 (3103-4-8)	5	
XFAC5355X88	1/2 X 1/2 (3103-8-8)	5	
XFAC5355X10	5/8 X 1/2 (3103-8-10)	1	
XFAC5355X106	5/8 X 3/8 (3103-6-10)	1	
XFAC5355X12	3/4 X 3/4 (3103-12-12)	1	
XFAC5355X128	3/4 X 1/2 (3103-8-12)	1	
XFAC5355X14	7/8 X 3/4 (3103-12-14)	1	
XFAC5355X16	1 X 1 (3103-16-16)	1	
XFAC5355X1612	1 X 3/4 (3103-12-16)	1	
XFAC5355X20	1 1/4 X 1-1/4 (3103-20-20)	1	
XFAC5355X24	1 1/2 X 1 1/2 (3103-24-24)	1	
XFAC5355X32	2 X 2 (3103-32-32)	1	

## JIC 90° MALE ELBOW

STEEL HYDRAULIC FITTING

Line: 669-00



PART NUMBER	SIZE	QTY/BX	LIST PRICE
XGAC5405X2	1/8 X 1/8 (2103-2-2)	5	
XGAC5405X3	3/16 X 1/8 (2103-2-3)	5	
XGAC5405X4	1/4 X 1/8 (2103-2-4)	5	
XGAC5405X44	1/4 X 1/4 (2103-4-4)	5	
XGAC5405X5	5/16 X 1/8 (2103-2-5)	5	
XGAC5405X54	5/16 X 1/4 (2103-4-5)	5	
XGAC5405X62	3/8 X 1/8 (2103-2-6)	5	
XGAC5405X6	3/8 X 1/4 (2103-4-6)	5	
XGAC5405X66	3/8 X 3/8 (2103-6-6)	5	
XGAC5405X68	3/8 X 1/2 (2103-8-6)	5	
XGAC5405X84	1/2 X 1/4 (2103-4-8)	5	
XGAC5405X8	1/2 X 3/8 (2103-6-8)	5	
XGAC5405X88	1/2 X 1/2 (2103-8-8)	5	
XGAC5405X812	1/2 X 3/4 (2103-12-8)	5	
XGAC5405X106	5/8 X 3/8 (2103-6-10)	1	
XGAC5405X10	5/8 X 1/2 (2103-8-10)	5	
XGAC5405X1012	5/8 X 3/4 (2103-12-10)	1	
XGAC5405X128	3/4 X 1/2 (2103-8-12)	1	
XGAC5405X12	3/4 X 3/4 (2103-12-12)	1	
XGAC5405X1216	3/4 X 1 (2103-16-12)	1	
XGAC5405X14	7/8 X 3/4 (2103-12-14)	1	
XGAC5405X1612	1 X 3/4 (2103-12-16)	1	
XGAC5405X16	1 X 1 (2103-16-16)	1	
XGAC5405X2016	1 1/4 X 1 (2103-16-20)	1	
XGAC5405X20	1 1/4 X 1 1/4 (2103-20-20)	1	
XGAC5405X24	1 1/2 X 1 1/2 (2103-24-24)	1	
XGAC5405X32	2 X 2 (2103-32-32)	1	

## JIC LONG MALE ELBOW

STEEL HYDRAULIC FITTING

Line: 670-00



PART NUMBER	SIZE	QTY/BX	LIST PRICE
XHAC5425X4	1/4 X 1/8 (5603-2-4)	5	
XHAC5425X44	1/4 X 1/4 (5603-4-4)	5	
XHAC5425X5	5/16 X 1/8 (5603-2-5)	5	
XHAC5425X6	3/8 X 1/4 (5603-4-6)	5	
XHAC5425X8	1/2 X 3/8 (5603-6-8)	5	
XHAC5425X88	1/2 X 1/2 (5603-8-8)	5	
XHAC5425X10	5/8 X 1/2 (5603-8-10)	1	
XHAC5425X12	3/4 X 3/4 (5603-12-12)	1	
XHAC5425X16	1 X 1 (5603-16-16)	1	
XHAC5425X20	1 1/4 X 1 1/4 (5603-20-20)	1	

### JIC EXTRA LONG 90° MALE ELBOW

STEEL HYDRAULIC FITTING



Line: 671-00

PART NUMBER	SIZE	QTY/BX	LIST PRICE
XJAC5435X5	5/16 X 1/8 (5703-2-5)	5	
XJAC5435X6	3/8 X 1/4 (5703-4-6)	5	
XJAC5435X8	1/2 X 3/8 (5703-6-8)	5	
XJAC5435X10	5/8 X 1/2 (5703-8-10)	1	
XJAC5435X12	3/4 X 3/4 (5703-12-12)	1	
XJAC5435X16	1 X 1 (5703-16-16)	1	

### JIC 90° FEMALE ELBOW

STEEL HYDRAULIC FITTING

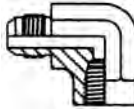

Line: 672-00

PART NUMBER	SIZE	QTY/BX	LIST PRICE
XKAC5455X4	1/4 X 1/8 (2203-2-4)	5	
XKAC5455X44	1/4 X 1/4 (2203-4-4)	5	
XKAC5455X5	5/16 X 1/8 (2203-2-5)	5	
XKAC5455X62	3/8 X 1/8 (2203-2-6)	5	
XKAC5455X6	3/8 X 1/4 (2203-4-6)	5	
XKAC5455X66	3/8 X 3/8 (2203-6-6)	5	
XKAC5455X84	1/2 X 1/4 (2203-4-8)	5	
XKAC5455X8	1/2 X 3/8 (2203-6-8)	5	
XKAC5455X88	1/2 X 1/2 (2203-8-8)	5	
XKAC5455X10	5/8 X 1/2 (2203-8-10)	1	
XKAC5455X128	3/4 X 1/2 (2203-8-12)	1	
XKAC5455X12	3/4 X 3/4 (2203-12-12)	1	
XKAC5455X14	7/8 X 3/4 (2203-12-14)	1	
XKAC5455X16	1 X 1 (2203-16-16)	1	
XKAC5455X20	1 1/4 X 1 1/4 (2203-20-20)	1	
XKAC5455X24	1 1/2 X 1 1/2 (2203-24-24)	1	
XKAC5455X32	2 X 2 (2203-32-32)	1	

### JIC MALE BRANCH TEE

STEEL HYDRAULIC FITTING

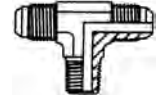

Line: 673-00

PART NUMBER	SIZE	QTY/BX	LIST PRICE
XMAC5605X3	3/16 X 1/8 (213T-2-3)	5	
XMAC5605X4	1/4 X 1/8 (213T-2-4)	5	
XMAC5605X444	1/4 X 1/4 (213T-4-4)	5	
XMAC5605X5	5/16 X 1/8 (213T-2-5)	5	
XMAC5605X6	3/8 X 1/4 (213T-4-6)	5	
XMAC5605X8	1/2 X 3/8 (213T-6-8)	5	
XMAC5605X888	1/2 X 1/2 (213T-8-8)	5	
XMAC5605X10	5/8 X 1/2 (213T-8-10)	1	
XMAC5605X12	3/4 X 3/4 (213T-12-12)	1	
XMAC5605X14	7/8 X 3/4 (213T-12-14)	1	
XMAC5605X16	1 X 1 (213T-16-16)	1	
XMAC5605X20	1 1/4 X 1 1/4 (213T-20-20)	1	
XMAC5605X24	1 1/2 X 1 1/2 (213T-24-24)	1	
XMAC5605X32	2 X 2 (213T-32-32)	1	

### JIC FEMALE BRANCH TEE

STEEL HYDRAULIC FITTING

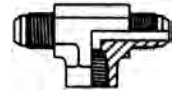

Line: 674-00

PART NUMBER	SIZE	QTY/BX	LIST PRICE
XNAC5655X3	3/16 X 1/8 (223T-2-3)	5	
XNAC5655X4	1/4 X 1/8 (223T-2-4)	5	
XNAC5655X5	5/16 X 1/8 (223T-2-5)	5	
XNAC5655X6	3/8 X 1/4 (223T-4-6)	5	
XNAC5655X8	1/2 X 3/8 (223T-6-8)	5	
XNAC5655X10	5/8 X 1/2 (223T-8-10)	1	
XNAC5655X12	3/4 X 3/4 (223T-12-12)	1	
XNAC5655X14	7/8 X 3/4 (223T-12-14)	1	
XNAC5655X16	1 X 1 (223T-16-16)	1	
XNAC5655X20	1 1/4 X 1 1/4 (223T-20-20)	1	
XNAC5655X24	1 1/2 X 1 1/2 (223T-24-24)	1	
XNAC5655X32	2 X 2 (223T-32-32)	1	



**CALL - 1 (800) 723-2826**

## JIC MALE RUN TEE

STEEL HYDRAULIC FITTING

Line: 675-00

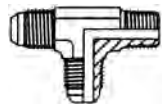

PART NUMBER	SIZE	QTY/BX	LIST PRICE
XPAC5755X3	3/16 X 1/8 (013T-2-3)	5	
XPAC5755X4	1/4 X 1/8 (013T-2-4)	5	
XPAC5755X444	1/4 X 1/4 (013T-4-4)	5	
XPAC5755X5	5/16 X 1/8 (013T-2-5)	5	
XPAC5755X6	3/8 X 1/4 (013T-4-6)	5	
XPAC5755X8	1/2 X 3/8 (013T-6-8)	5	
XPAC5755X888	1/2 X 1/2 (013T-8-8)	5	
XPAC5755X10	5/8 X 1/2 (013T-8-10)	1	
XPAC5755X12X	3/4 X 3/4 (013T-12-12)	1	
XPAC5755X16	1 X 1 (013T-16-16)	1	
XPAC5755X20	1 1/4 X 1 1/4 (013T-20-20)	1	
XPAC5755X24	1 1/2 X 1 1/2 (013T-24-24)	1	
XPAC5755X32	2 X 2 (013T-32-32)	1	

## JIC FEMALE RUN TEE

STEEL HYDRAULIC FITTING

Line: 676-00



PART NUMBER	SIZE	QTY/BX	LIST PRICE
XRAC5805X3	3/16 X 1/8 (023T-2-3)	5	
XRAC5805X4	1/4 X 1/8 (023T-2-4)	5	
XRAC5805X6	3/8 X 1/4 (023T-4-6)	5	
XRAC5805X8	1/2 X 3/8 (023T-6-8)	5	
XRAC5805X10	5/8 X 1/2 (023T-8-10)	1	
XRAC5805X12	3/4 X 3/4 (023T-12-12)	1	
XRAC5805X16	1 X 1 (023T-16-16)	1	
XRAC5805X20	1 1/4 X 1 1/4 (023T-20-20)	1	
XRAC5805X24	1 1/2 X 1 1/2 (023T-24-24)	1	

## JIC FEMALE BULKHEAD CONNECTOR

STEEL HYDRAULIC FITTING

Line: 676-01

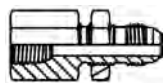

PART NUMBER	SIZE	QTY/BX	LIST PRICE
JCUC5275X4	1/4 X 1/8 (0253-2-4)	5	
JCUC5275X6	3/8 X 1/4 (0253-4-6)	5	
JCUC5275X8	1/2 X 3/8 (0253-6-8)	5	
JCUC5275X10	5/8 X 1/2 (0253-8-10)	1	
JCUC5275X12	3/4 X 3/4 (0253-12-12)	1	
JCUC5275X14	7/8 X 3/4 (0253-12-14)	1	
JCUC5275X16	1 X 1 (0253-16-16)	1	
JCUC5275X20	1 1/4 X 1 1/4 (0253-20-20)	1	

## JIC STRAIGHT THD O-RING MALE CONN

STEEL HYDRAULIC FITTING

Line: 677-00

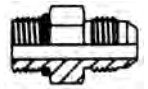

PART NUMBER	SIZE	QTY/BX	LIST PRICE
XSAC5315X2	1/8 X 1/8 (0503-2-2)	5	
XSAC5315X3X	3/16 X 3/16 (0503-3-3)	5	
XSAC5315X4	1/4 X 1/4 (0503-4-4)	5	
XSAC5315X43	1/4 X 3/16	2	
XSAC5315X45	1/4 X 5/16 (0503-5-4)	5	
XSAC5315X46	1/4 X 3/8 (0503-6-4)	5	
XSAC5315X48	1/4 X 1/2	5	
XSAC5315X410	1/4J X -10 (6400-4-10)	5	
XSAC5315X5	5/16 X 5/16 (0503-5-5)	5	
XSA6400X6X5	-5MORT X -6 MJIC	5	
XSAC5315X6	3/8 X 3/8 (0503-6-6)	5	
XSAC5315X68	3/8 X 1/2 (0503-8-6)	5	
XSAC5315X86	1/2 X 3/8 (0503-6-8)	1	
XSAC5315X8	1/2 X 1/2 (0503-8-8)	5	
XSAC5315X810	1/2 X 5/8 (0503-10-8)	5	
XSAC5315X812	1/2 X 3/4 (0503-12-8)	5	
XSAC5315X8X16	1/2 X 1	5	
XSAC5315X108	5/8 X 1/2 (0503-8-10)	1	
XSAC5315X10	5/8 X 5/8 (0503-10-10)	1	
XSAC5315X1012	5/8 X 3/4 (0503-12-10)	1	
XSAC5315X128	3/4 X 1/2 (0503-8-12)	1	
XSAC53151210	3/4 X 5/8 (0503-10-12)	1	
XSAC5315X12	3/4 X 3/4 (0503-12-12)	1	
XSAC5315X1216	3/4 X 1 (0503-16-12)	1	
XSA6400X1220	3/4 X 1 1/4	1	
XSAC5315X14	7/8 X 7/8 (0503-14-14)	1	
XSAC5315X1612	1 X 3/4 (0503-12-16)	1	
XSAC5315X16	1 X 1 (F50X-S)	1	
XSAC5315X1620	1 X 1 1/4 (0503-20-16)	1	
XSAC5315X2016	1 1/4 X 1 (0503-16-20)	1	
XSAC5315X20	1 1/4 X 1 1/4 (0503-20-20)	1	
XSAC5315X24	1 1/2 X 1 1/2 (0503-24-24)	1	
XSAC5315X32	2 X 2 (0503-32-32)	1	

## JIC/STRAIGHT THREAD O-RING EXTENDED MALE

STEEL HYDRAULIC CONNECTOR

Line: 678-00

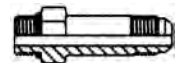

PART NUMBER	SIZE	QTY/BX	LIST PRICE
XTAC5316X4	1/4 X 1/4 (5E03-4-4)	5	
XTAC5316X6	3/8 X 3/8 (5E03-6-6)	5	
XTAC5316X8	1/2 X 1/2 (5E03E-8-8)	5	
XTAC5316X10	5/8 X 5/8 (5E03-10-10)	1	
XTAC5316X12	3/4 X 3/4 (5E03-12-12)	1	
XTAC5316X16	1 X 1 (5E03-16-16)	1	
XTAC5316X20	1 1/4 X 1 1/4 (5E03-20-20)	1	

**JIC/STRAIGHT THD O-RING 45° MALE ELBOW**

STEEL HYDRAULIC



Line: 679-00

PART NUMBER	SIZE	QTY/BX	LIST PRICE
XUAC5365X4	1/4 X 1/4 (3503-4-4)	5	
XUAC5365X46	1/4 X 3/8	5	
XUAC5365X5	5/16 X 5/16 (3503-5-5)	5	
XUAC5365X6	3/8 X 3/8 (3503-6-6)	5	
XUAC5365X8	1/2 X 1/2 (3503-8-8)	5	
XUAC5365X810	1/2 X 5/8 (3503-10-8)	5	
XUAC5365X10	5/8 X 5/8 (3503-10-10)	1	
XUAC53651210	3/4 X 5/8 12-10V5X	1	
XUAC5365X12	3/4 X 3/4 (3503-12-12)	1	
XUAC5365X14	7/8 X 7/8 (3503-14-14)	1	
XUAC5365X16	1 X 1 (3503-16-16)	1	
XUAC5365X20	1 1/4 X 1 1/4 (3503-20-20)	1	
XUAC5365X24	1 1/2 X 1 1/2 (3503-24-24)	1	
XUAC5365X32	2 X 2 (3503-32-32)	1	

**JIC/STRAIGHT THD O-RING 90° MALE ELBOW**

STEEL HYDRAULIC



Line: 680-00

PART NUMBER	SIZE	QTY/BX	LIST PRICE
XVAC5515X2	1/8 X 1/8 (2503-2-2)	5	
XVAC5515X3	3/16 X 3/16 (2503-3-3)	5	
XVAC5515X4	1/4 X 1/4 (2503-4-4)	5	
XVAC5515X45	1/4 X 5/16	5	
XVAC5515X46	1/4 X 3/8 (6801-4-6)	5	
XVAC5515X5	5/16 X 5/16 (2503-5-5)	5	
XVA6801X65	3/8 X 5/16	2	
XVAC5515X6	3/8 X 3/8 (2503-6-6)	5	
XVAC5515X68	3/8 X 1/2 (2503-8-6)	5	
XVAC5515X610	3/8 X 5/8 (6801-6-10)	5	
XVAC5515X86	1/2 X 3/8 (2503-6-8)	5	
XVAC5515X8	1/2 X 1/2 (2503-8-8)	5	
XVAC5515X8L	1/2 X 1/2 (LONG 550388)	5	
XVAC5515X810	1/2 X 5/8 (2503-10-8)	5	
XVA2062-12-85	1/2 X 3/4	5	
XVAC5515X106	5/8 X 3/8 (10-6C50XS)	5	
XVAC5515X10	5/8 X 5/8 (2503-10-10)	1	
XVAC55151012F	5/8 X 3/4 FORGED	2	
XVA6801X1016	5/8 X 1	1	
XVAC5515X1210	3/4 X 5/8 (2503-10-12)	1	
XVAC5515X12	3/4 X 3/4 (2503-12-12)	1	
XVAC5515X1216	3/4 X 1 (2503-16-12)	5	
XVAC5515X14	7/8 X 7/8 (2503-14-14)	1	
XVAC55151612	1 X 3/4 (2503-12-16)	5	

(continued...)

**JIC/STRAIGHT THD O-RING 90° MALE ELBOW (cont.)**

STEEL HYDRAULIC

Line: 680-00

PART NUMBER	SIZE	QTY/BX	LIST PRICE
XVATF55151612	1 X 3/4	1	
XVATF5515X16	1 X 1	1	
XVAC5515X16	1 X 1 (2503-16-16)	1	
XVAC5515X20	1 1/4 X 1 1/4 (2503-20-20)	1	
XVAC5515X24	1 1/2 X 1 1/2 (2503-24-24)	1	
XVAC5515X32	2 X 2 (2503-32-32)	1	

**JIC/STRAIGHT THD O-RING MALE BR TEE**

STEEL HYDRAULIC



Line: 681-00

PART NUMBER	SIZE	QTY/BX	LIST PRICE
XWAC5715X4	1/4 X 1/4 (253T-4-4)	5	
XWAC5715X5	5/16 X 5/16 (253T-5-5)	5	
XWAC5715X6	3/8 X 3/8 (253T-6-6)	5	
XWAC5715X8	1/2 X 1/2 (253T-8-8)	5	
XWAC5715X10	5/8 X 5/8 (253T-10-10)	1	
XWAC5715X12	3/4 X 3/4 (253T-12-12)	1	
XWAC5715X14	7/8 X 7/8 (253T-14-14)	1	
XWAC5715X16	1 X 1 (S5X-S)	1	
XWAC5715X20	1 1/4 X 1 1/4 (253T-20-20)	1	
XWAC5715X24	1 1/2 X 1 1/2 (253T-24-24)	1	
XWAC5715X32	2 X 2 (253T-32-32)	1	

**JIC/STRAIGHT THD O-RING MALE RUN TEE**

STEEL HYDRAULIC



Line: 682-00

PART NUMBER	SIZE	QTY/BX	LIST PRICE
XXAC5716X4	1/4 X 1/4 (053T-4-4)	5	
XXAC5716X5	5/16 X 5/16 (053T-5-5)	5	
XXAC5716X6	3/8 X 3/8 (053T-6-6)	5	
XXAC5716X8	1/2 X 1/2 (053T-8-8)	5	
XXAC5716X10	5/8 X 5/8 (053T-10-10)	1	
XXAC5716X12	3/4 X 3/4 (053T-12-12)	1	
XXAC5716X14	7/8 X 7/8 (053T-14-14)	1	
XXAC5716X16	1 X 1 (053T-16-16)	1	
XXAC5716X20	1 1/4 X 1 1/4 (053T-20-20)	1	
XXAC5716X24	1 1/2 X 1 1/2 (053T-24-24)	1	
XXAC5716X32	2 X 2 (053T-32-32)	1	

## JIC/INVERTED MALE ADAPTER

STEEL HYDRAULIC

Line: 683-00

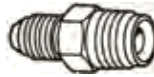

PART NUMBER	SIZE	QTY/BX	LIST PRICE
XYAC5880X4	1/4 X 1/4	5	
XYAC5880X5	5/16 X 5/16	5	
XYAC5880X6	3/8 X 3/8	5	
XYAC5880X8	1/2 X 1/2	5	

## SWIVEL STRAIGHT FPT/MPT

STEEL HYDRAULIC ADAPTER

Line: 684-00



PART NUMBER	SIZE	QTY/BX	LIST PRICE
YYA9205X22	1/8 X 1/8 (0107-2-2)	5	
YYA9205X42	1/4 X 1/8	5	
YYA9205X44	1/4 X 1/4 (0107-4-4)	5	
YYA9205X46	1/4SWV X 3/8MP (0107-64)	5	
YYA9205X64	3/8 X 1/4 (0107-4-6)	5	
YYA9205X66	3/8 X 3/8 (0107-6-6)	5	
YYA9205X68	3/8 X 1/2 (0107-8-6)	5	
YYA9205X812	1/2SWV X 3/4MP (0107128)	5	
YYA9205X86	1/2 X 3/8 (0107-6-8)	5	
YYA9205X88	1/2 X 1/2 (0107-8-8)	5	
YYA9205X1212	3/4 X 3/4 (0107-12-12)	1	
YYA9205X1216	3/4 X 1 (0107-16-12)	1	
YYA9205X128	3/4SW X 1/2MP (0107-812)	1	
YYA9205X1616	1 X 1 (0107-16-16)	1	
YYA9205X1612	1 X 3/4 (0107-12-16)	1	
YYA9205X1620	1 SWV X 1 1/4 MP)	1	
YYA9205X2020	1 1/4 X 1 1/4 (01072020)	1	
YYA9205X2424	1 1/2 X 1 1/2 (0107-24-24)	1	
YYA9205X3232	2SW X 2 MP (0107-32-32)	1	

## SWIVEL STRAIGHT FPT/MPT 45° ELBOW

STEEL HYDRAULIC

Line: 685-00



PART NUMBER	SIZE	QTY/BX	LIST PRICE
YZA9355X22	1/8SWV X 1/8MP (3107-22)	5	
YZA9355X44	1/4 X 1/4 (3107-4-4)	5	
YZA9355X66	3/8 X 3/8 (3107-6-6)	5	
YZA9355X68	3/8SWV X 1/2MP (3107-86)	5	
YZA9355X812	1/2SWV X 3/4MP (3107128)	5	
YZA9355X86	1/2 SWV X 3/8 MP	5	
YZA9355X88	1/2 X 1/2 (3107-8-8)	5	
YZA9355X1212	3/4 X 3/4 (3107-12-12)	1	
YZA9355X128	3/4SWV X 1/2MP (3107812)	1	
YZA9355X1616	1 X 1 (3107-16-16)	1	
YZA9355X2020	1 1/4 X 1 1/4 (31072020)	1	
YZA9355X2424	1 1/2 X 1 1/2 (31072424)	1	
YZA9355X3232	2 X 2 (31073232)	1	

## SWIVEL STRAIGHT FPT/MPT 90° ELBOW

STEEL HYDRAULIC ADAPTER

Line: 686-00

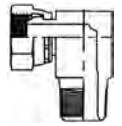

PART NUMBER	SIZE	QTY/BX	LIST PRICE
ZAA9405X22	1/8 X 1/8 (2107-2-2)	5	
ZAA9405X44	1/4 X 1/4 (2107-4-4)	5	
ZAA9405X46	1/4SWV X 3/8MP (2107-64)	5	
ZAA9405X64	3/8SWV X 1/4MP (2107-46)	5	
ZAA9405X66	3/8 X 3/8 (2107-6-6)	5	
ZAA9405X68	3/8SWV X 1/2 MP (2107-86)	5	
ZAA9405X86	1/2 X 3/8 (2107-6-8)	5	
ZAA9405X88	1/2 X 1/2 (2107-8-8)	5	
ZAA9405X812	1/2SWV X 3/4 MP(2107-128)	5	
ZAA9405X128	3/4SW X 1/2MP(2107812)	1	
ZAA9405X1212	3/4 X 3/4 (2107-12-12)	1	
ZAA9405X1612	1SW X 3/4MP(21071216)	1	
ZAA9405X1616	1 X 1 (2107-16-16)	1	
ZAA9405X2020	1 1/4 X 1 1/4 (21072020)	1	
ZAA9405X2424	1 1/2 X 1 1/2 (21072424)	1	
ZAA9405X3232	2 X 2 (2107-3232)	1	

## SWIVEL STRAIGHT FPT/FPT

STEEL HYDRAULIC ADAPTER

Line: 687-00

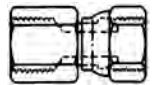

PART NUMBER	SIZE	QTY/BX	LIST PRICE
ZBA9255X22	1/8 X 1/8 (0207-2-2)	5	
ZBA9255X44X	1/4 X 1/4 (0207-4-4)	5	
ZBA9255X66	3/8 X 3/8 (0207-6-6)	5	
ZBA9255X68	3/8 SWV X 1/2 FP	5	
ZBA9255X88	1/2 X 1/2 (0207-8-8)	5	
ZBA9255X128	3/4 SWV X 1/2 FP	1	
ZBA9255X1212	3/4 X 3/4 (0207-12-12)	1	
ZBA9255X1616	1 X 1 (0207-16-16)	1	
ZBA9255X2020	1 1/4 X 1 1/4 (02072020)	1	
ZBA9255X2424	1 1/2 SWV X 1 1/2FP)	1	
ZBA9255X3232	2 X 2 (0207-32-32)	1	

### SWIVEL STRAIGHT FPT/FPT 45° ELBOW

STEEL HYDRAULIC ADAPTER

Line: 688-00

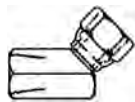

PART NUMBER	SIZE	QTY/BX	LIST PRICE
ZCA9385X22	1/8 SWV X 1/8 FP	5	
ZCA9385X44	1/4 X 1/4	5	
ZCA9385X66	3/8 X 3/8	5	
ZCA9385X68	3/8 SWV X 1/2 FP	5	
ZCA9385X88	1/2 X 1/2	5	
ZCA9385X1212	3/4 X 3/4	1	
ZCA9385X1616	1 X 1	1	
ZCA9385X2020	1 1/4 SWV X 1 1/4 FP	1	
ZCA9385X2424	1 1/2 SWV X 1 1/2 FP	1	
ZCA9385X3232	2 SWV X 1 1/2 FP	1	

### SWIVEL STRAIGHT FPT X FPT 90° ELBOW

STEEL HYDRAULIC ADAPTER

Line: 689-00

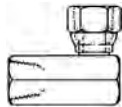

PART NUMBER	SIZE	QTY/BX	LIST PRICE
ZDA9455X22	1/8SWV X 1/8FP (2207-22)	5	
ZDA9455X44	1/4 X 1/4 (2207-4-4)	5	
ZDA9455X46	1/4 SWV X 3/8 FP	5	
ZDA9455X64	3/8 SWV X 1/4 FP	5	
ZDA9455X66	3/8 X 3/8 (2207-6-6)	5	
ZDA9455X68	3/8 SWV X 1/2 FP	5	
ZDA9455X86	1/2 SWV X 3/8 FP	5	
ZDA9455X88	1/2 X 1/2 (2207-8-8)	5	
ZDA9455X1212	3/4 X 3/4 (2207-12-12)	1	
ZDA9455X1616	1 X 1 (2207-16-16)	1	
ZDA9455X2020	1 1/4 X 1 1/4 (2207-20-20)	1	
ZDA9455X2424	1 1/2 X 1 1/2 (2207-24-24)	1	
ZDA9455X3232	2SWV X 2FP (2207-3232)	1	

### MORT/STRAIGHT FPT SWIVEL

STEEL HYDRAULIC ADAPTER

Line: 690-00

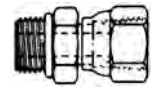

PART NUMBER	SIZE	QTY/BX	LIST PRICE
ZEA9315X44	7/16-20 X 1/4 (050744)	5	
ZEA9315X46	7/16-20 X 3/8	5	
ZEA9315X64	9/16 X 1/4SWV (0507-6-4)	5	
ZEA9315X68	9/16 X 1/2 (0507-6-8)	5	
ZEA9315X66	9/16-18 X 3/8 (050766)	5	
ZEA9315X86	3/4-16 X 3/8 (0507-86)	5	
ZEA9315X88	3/4-16 X 1/2 (0507-88)	5	
ZEA9315X106	7/8-14 X 3/8 (0507-106)	1	
ZEA9315X108	7/8-14X1/2 (0507-108)	1	
ZEA9315X1012	7/8-14 X 3/4	1	
ZEA9315X1212	1 1/16 X 3/4 (0507-1212)	1	
ZEA9315X1616	1 5/16 X 1 (0507-1616)	1	
ZEA9315X2424	1 1/2 X 1 1/2	1	
ZEA9315X2020	1 5/8 X 1 1/4 (05072020)	1	
ZEA9315X3232	2 1/2 X 2 (0507-3232)	1	

### MORT/STRAIGHT FPT 90° ELBOW

STEEL HYDRAULIC ADAPTER

Line: 691-00



PART NUMBER	SIZE	QTY/BX	LIST PRICE
ZGA9515X44	7/16-20 X 1/4 (250744)	5	
ZGA9515X46	7/16-20 X 3/8 SWVL	5	
ZGA9515X66	9/16-18 X 3/8 (250766)	5	
ZGA9515X68	9/16-18 X 1/2	5	
ZGA9515X86	3/4-16 X 3/8 (2507-86)	5	
ZGA9515X88	3/4-16 X 1/2 (2507-88)	5	
ZGA9515X108	7/8-14 X 1/2 (2507108)	1	
ZGA9515X128	1 1/16 X 1/2 (2507-12-8)	1	
ZGA9515X1212	1 1/16 X 3/4 (2507-1212)	1	
ZGA9515X1616	1 5/16 X 1 (25071616)	1	
ZGA9515X2012	1 5/8-12 X 3/4	1	
ZGA9515X2020	1 5/8 X 1 1/4 (2507-20-20)	1	
ZGA9515X3232	2 1/2 X 2 (2507-32-32)	1	



**CALL - 1 (800) 723-2826**

#### ACRONYM KEY:

MPT	MALE PIPE THREAD
FPT	FEMALE PIPE THREAD
MORT	MALE O-RING THREAD
SWV	FEMALE SWIVEL



### 45° ELBOW MALE O-RING\FEMALE PIPE SWIVEL

STEEL HYDRAULIC

Line: 691-01



PART NUMBER	SIZE	QTY/BX	LIST PRICE
JWT9365X44	7/16-2 X 1/4 (3507-4-4)	5	
JWT9365X46	7/16-20 X 3/8	5	
JWT9365X66	9/16-18 X 3/8 (3507-6-6)	5	
JWT9365X68	9/16-18 X 1/2	5	
JWT9365X88	3/4-16 X 1/2 (3507-8-8)	5	
JWT9365X108	7/8-14 X 1/2 (3507-10-8)	1	
JWT9365X1212	1 1/16 X 3/4 (3507-1212)	1	
JWT9365X1616	1 5/16 X 1 (35071616)	1	
JWT9365X2020	1 5/8-12 X 1 1/4	1	
JWT9365X2424	1 7/8-12 X 1 1/2	1	

### SWIVEL MPT\FPT SAE 90° ELBOW

STEEL HYDRAULIC ADAPTER

Line: 692-00



PART NUMBER	SIZE	QTY/BX	LIST PRICE
ZHA9151X6X6	5/8-18F X 5/8-18M	5	
ZHA9151X8X8	3/4-16F X 3/4-16M	5	
ZHA9151X10X10	7/8-14F X 7/8-14M	1	

### SWIVEL MPT\FPT SAE 45° ELBOW

STEEL HYDRAULIC ADAPTER

Line: 693-00



PART NUMBER	SIZE	QTY/BX	LIST PRICE
ZJA9154X6X6	3/8 X 5/8-18	5	
ZJA9154X8X8	1/2 X 3/4-16	5	
ZJA9154X10X10	5/8 X 7/8-14	5	

### ACRONYM KEY:

MPT	MALE PIPE THREAD
FPT	FEMALE PIPE THREAD
MORT	MALE O-RING THREAD
SWV	FEMALE SWIVEL

### JIC FPT SWIVEL/MPT STRAIGHT

STEEL HYDRAULIC ADAPTER

Line: 693-01

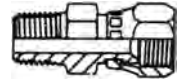

PART NUMBER	SIZE	QTY/BX	LIST PRICE
JXT9100X44	1/4 JIC X 1/4 MPT	5	
JXT9100X54	5/16 JIC X 1/4 MPT	5	
JXT9100X64	3/8 JIC X 1/4 MPT	5	
JXT9100X66	3/8 JIC X 3/8 MPT	5	
JXT9100X86	1/2 JIC X 3/8 MPT	5	
JXT9100X88	1/2 JIC X 1/2 MPT	5	
JXT9100X106	5/8 JIC X 3/8 MPT	1	
JXT9100X108	5/8 JIC X 1/2 MPT	1	
JXT9100X128	3/4 JIC X 1/2 MPT	1	
JXT9100X1212	3/4 JIC X 3/4 MPT	1	
JXT9100X1612	1 JIC X 3/4 MPT	1	
JXT9100X1616	1 JIC X 1 MPT	1	
JXT9100X2020	1 1/4 JIC X 1 1/4 MPT	1	

### FPT JIC SWIVEL MALE O-RING THREAD

STEEL HYDRAULIC ADAPTER

Line: 693-02



PART NUMBER	SIZE	QTY/BX	LIST PRICE
AWZ506X4	1/4 (C5216X4X4 F65X)	5	
AWZ506X5	5/16 5 (F65X)	5	
AWZ506X6	3/8 (C5216X6X6 F65X)	5	
AWZ506X8X6	1/2 X 3/4-16 (C5216)	5	
AWZ506X8	1/2 (C5216X8X8 F65X)	5	
AWZ506X10	5/8 (C5216X1010 F65X)	2	
AWZ506X12	3/4 (C5216X1212 F65X)	2	
AWZ506X16	1 (C5216X16X16 F65X)	2	
AWZ506X20	1 1/4 (C5216X20 F65X)	1	

### HEX PIPE PLUG

STEEL HIGH PRESSURE

Line: 694-00

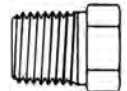

PART NUMBER	SIZE	QTY/BX	LIST PRICE
XZAC3159X2	1/8 (01CP-2)	5	
XZAC3159X4	1/4 (01CP-4)	5	
XZAC3159X6	3/8 (01CP-6)	5	
XZAC3159X8	1/2 (01CP-8)	5	
XZAC3159X12	3/4 (01CP-12)	5	
XZAC3159X16	1 (01CP-16)	5	

### HEX SOCKET PIPE PLUG

STEEL HIGH PRESSURE

Line: 695-00



PART NUMBER	SIZE	QTY/BX	LIST PRICE
YAAC3169X1	1/16 (01HP-1)	5	
YAAC3169X2	1/8 (01HP-2)	5	
YAAC3169X4	1/4 (01HP-4)	5	

### PIPE THREAD COUPLING

STEEL HIGH PRESSURE

Line: 696-00

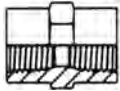

PART NUMBER	SIZE	QTY/BX	LIST PRICE
YCAC3309X2	1/8 (0202-2)	5	
YCAC3309X4	1/4 (0202-4)	5	
YCAC3309X24	1/4 X 1/8	5	
YCAC3309X6	3/8 (0202-6)	5	
YCAC3309X26	3/8 X 1/8	5	
YCAC3309X46	3/8 X 1/4 GG-S	5	
YCAC3309X8	1/2 (0202-8)	5	
YCAC3309X48	1/2 X 1/4	5	
YCAC3309X68	1/2 X 3/8	5	
YCAC3309X12	3/4 (0202-12)	1	
YCAC3309X412	3/4 X 1/4	5	
YCAC3309X812	3/4 X 1/2	5	
YCAC3309X16	1 (0202-16)	1	
YCAC3309X20	1 1/4	1	
YCAC3309X2424	1 1/2 (0202-24-24)	1	

### HEX PIPE THREAD NIPPLE

STEEL HIGH PRESSURE

Line: 697-00



PART NUMBER	SIZE	QTY/BX	LIST PRICE
YDAC3069X2	1/8 (0101-2-2)	5	
YDAC3069X4	1/4 (0101-4-4)	5	
YDAC3069X42	1/4 X 1/8 (0101-2-4)	5	
YDAC3069X6	3/8 (0101-6-6)	5	
YDAC3069X62	3/8 X 1/8 (0101-2-6)	5	
YDAC3069X64	3/8 X 1/4 (0101-4-6)	5	
YDAC3069X8	1/2 (0101-8-8)	5	
YDAC3069X84	1/2 X 1/4 (0101-4-8)	5	
YDAC3069X86	1/2 X 3/8 (0101-6-8)	5	
YDAC3069X12	3/4 (0101-12-12)	5	
YDAC3069X128	3/4 X 1/2 (0101-8-12)	5	
YDAC3069X166	1 X 3/8	5	
YDAC3069X16	1 (0101-16-16)	1	
YDAC3069X20	1 1/4 (0101-20-20)	1	

### 45° PIPE STREET ELBOW

STEEL HIGH PRESSURE

Line: 698-00

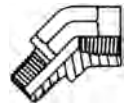

PART NUMBER	SIZE	QTY/BX	LIST PRICE
YEAC3359X2	1/8 (3102-2-2)	5	
YEAC3359X4	1/4 (3102-4-4)	5	
YEAC3359X6	3/8 (3102-6-6)	5	
YEAC3359X8	1/2 (3102-8-8)	5	
YEAC3359X12	3/4 (3102-12-12)	1	
YEAC3359X16	1 (3102-16-16)	1	

### 90° PIPE STREET ELBOW

STEEL HIGH PRESSURE

Line: 699-00

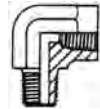

PART NUMBER	SIZE	QTY/BX	LIST PRICE
YFAC3409X2	1/8 (2102-2-2)	5	
YFAC3409X4	1/4 (2102-4-4)	5	
YFAC3409X6	3/8 (2102-6-6)	5	
YFAC3409X8	1/2 (2102-8-8)	5	
YFAC3409X12	3/4 (2102-12-12)	5	
YFAC3409X16	1 1 CD-5	1	
YFAC3409X20	1 1/4 (2102-20-20)	1	

### 90° FEMALE PIPE ELBOW

STEEL HIGH PRESSURE

Line: 700-00

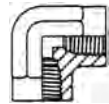

PART NUMBER	SIZE	QTY/BX	LIST PRICE
YGAC3509X2	1/8 (2202-2-2)	5	
YGAC3509X4	1/4 (2202-4-4)	5	
YGAC3509X6	3/8 (2202-6-6)	5	
YGAC3509X8	1/2 (2202-8-8)	5	
YGAC3509X12	3/4 (2202-12-12)	5	
YGAC3509X16	1 (2202-16-16)	1	
YGAC3509X20	1 1/4 (2202-20-20)	1	

### 45° FEMALE PIPE ELBOW

STEEL HIGH PRESSURE

Line: 701-00

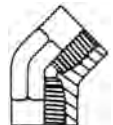

PART NUMBER	SIZE	QTY/BX	LIST PRICE
YHAC3559X2	1/8	5	
YHAC3559X4	1/4 (4202-4-4)	5	
YHAC3559X6	3/8 (4202-6-6)	5	
YHAC3559X8	1/2 (4202-8-8)	5	
YHAC3559X12	3/4 (4202-12-12)	5	
YHAC3559X16	1 (4202-16-16)	1	

## 90° FEMALE PIPE THREAD TEE

STEEL HIGH PRESSURE

Line: 702-00

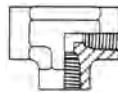

PART NUMBER	SIZE	QTY/BX	LIST PRICE
YJAC3709X2	1/8 (022T-2-2)	5	
YJAC3709X4	1/4 (022T-4-4)	5	
YJAC3709X6	3/8 (022T-6-6)	5	
YJAC3709X8	1/2 (022T-8-8)	5	
YJAC3709X12	3/4 (022T-12-12)	5	
YJAC3709X16	1 (022T-16-16)	1	
YJAC3709X20	1 1/4 (022T-20-20)	1	

## SEALING PIPE LOCKNUT

STEEL HIGH PRESSURE

Line: 703-00



PART NUMBER	SIZE	QTY/BX	LIST PRICE
YLAC3059X2	1/8	5	
YLAC3059X4	1/4	5	
YLAC3059X6	3/8	5	
YLAC3059X8	1/2	5	
YLAC3059X12	3/4	5	
YLAC3059X16	1	5	

## PIPE THREAD HEX BUSHING

STEEL HIGH PRESSURE

Line: 704-00



PART NUMBER	SIZE	QTY/BX	LIST PRICE
YMAC3109X42	1/4 X 1/8 (0102-4-2)	5	
YMAC3109X62	3/8 X 1/8 (0102-6-2)	5	
YMAC3109X64	3/8 X 1/4 (0102-6-4)	5	
YMAC3109X82X	1/2 X 1/8 (0102-8-2)	5	
YMAC3109X84	1/2 X 1/4 (0102-8-4)	5	
YMAC3109X86	1/2 X 3/8 (0102-8-6)	5	
YMAC3109X124	3/4 X 1/4 (0102-12-4)	5	
YMAC3109X126	3/4 X 3/8 (0102-12-6)	5	
YMAC3109X128	3/4 X 1/2 (0102-12-8)	5	
YMAC3109X166	1 X 3/8 (0102-16-6)	1	
YMAC3109X168	1 X 1/2 (0102-16-8)	1	
YMAC31091612	1 X 3/4 (0102-16-12)	1	
YMAC3109X2012	1 1/4 X 3/4 (01022012)	1	
YMAC31092016	1 1/4 X 1 (0102-20-16)	1	
YMAC3109X2420	1 1/2 X 1/4 (01022420)	1	

## 90° MALE PIPE THREAD ELBOW

STEEL HIGH PRESSURE

Line: 704-01



PART NUMBER	SIZE	QTY/BX	LIST PRICE
JYTC3529X2	1/8 (2101-2-2)	5	
JYTC3529X4	1/4 (2101-4-4)	5	
JYTC3529X6	3/8 (2101-6-6)	5	
JYTC3529X8	1/2 (2101-8-8)	5	
JYTC3529X12	3/4 (2101-12-12)	5	
JYTC3529X16	1 (2101-16-16)	1	

## MALE PIPE BRANCH TEE

STEEL HIGH PRESSURE

Line: 704-02

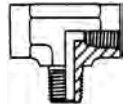

PART NUMBER	SIZE	QTY/BX	LIST PRICE
JZTC3609X2	1/8 (212T-2-2)	5	
JZTC3609X4	1/4 (212T-4-4)	5	
JZTC3609X6	3/8 (212T-6-6)	5	
JZTC3609X8	1/2 (212T-8-8)	1	
JZTC3609X12	3/4 (212T-12-12)	1	
JZTC3609X16	1 (212T-16-16)	1	

## MALE PIPE RUN TEE

STEEL HIGH PRESSURE

Line: 704-03

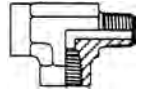

PART NUMBER	SIZE	QTY/BX	LIST PRICE
JAU3759X2	1/8 (012T-2-2)	5	
JAU3759X4	1/4 (012T-4-4)	5	
JAU3759X6	3/8 (012T-6-6)	5	
JAU3759X8	1/2 (012T-8-8)	1	
JAU3759X12	3/4 (012T-12-12)	1	
JAU3759X16	1 (012T-16-16)	1	

## PIPE THREAD CROSS

STEEL HIGH PRESSURE

Line: 704-04



PART NUMBER	SIZE	QTY/BX	LIST PRICE
JBUC3959X2	1/8 (022X-2-2)	5	
JBUC3959X4	1/4 (022X-4-4)	5	
JBUC3959X6	3/8 (022X-6-6)	5	
JBUC3959X8	1/2 (022X-8-8)	1	
JBUC3959X12	3/4 (022X-12-12)	1	
JBUC3959X16	1 (022X-16-16)	1	



CALL - 1 (800) 723-2826

### MALE BSPT/FPT STRAIGHT

CONVERSION ADAPTER

Line: 704-50

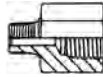

PART NUMBER	SIZE	QTY/BX	LIST PRICE
CEE02F3HG	ML1/8BSPT/1/8 FE-NPT	1	
CEE04F3HG	ML1/4BSPT/1/4 FE-NPT	1	
CEE06F3HG	ML3/8BSPT/3/8 FE-NPT	1	
CEE12F3HG	ML3/4BSPT/3/4 FE-NPT	1	
CEE16F3HG	ML1BSPT / 1FE-NPT	1	

### MALE BSPP/FORT STRAIGHT

CONVERSION ADAPTER

Line: 704-51

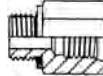

PART NUMBER	SIZE	QTY/BX	LIST PRICE
CEF0204F40HG5	ML1/8BSPT / -4 FORT	1	
CEF1212F40HG5	ML3/4 BSPP/-12 FORT	1	

### MALE BSPP/FPT

CONVERSION ADAPTER

Line: 704-52

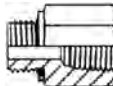

PART NUMBER	SIZE	QTY/BX	LIST PRICE
CEG02F40HG	ML1/8BSPP / 1/8 FPT	1	
CEG04F40HG	ML1/4BSPP / 1/4 FPT	1	
CEG06F40HG	ML3/8BSPP / 3/8 FPT	1	
CEG08F40HG	ML1/2BSPP / 1/2 FPT	1	
CEG12F40HG	ML3/4BSPP / 3/4 FPT	1	
CEG16F40HG	ML1BSPP / 1FPT	1	

### MALE METRIC/FPT

CONVERSION ADAPTER

Line: 704-53

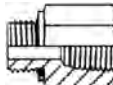

PART NUMBER	SIZE	QTY/BX	LIST PRICE
CEHM1002F80HG	ML M10-1.0X1/8 FPT	1	
CEHM1204F80HG	ML M12-1.5X1/4 FPT	1	
CEHM1404F80HG	ML M14-1.5 X 1/4 FPT	1	
CEHM1606F80HG	ML M16-1.5X 3/8 FPT	1	
CEHM1608F80HG	ML M16-1.5X 1/2 FPT	1	
CEHM1806F80HG	ML M18-1.5X 3/8 FPT	1	
CEHM1808F80HG	ML M18-1.5X 1/2 FPT	1	
CEHM2208F80HG	ML M22-1.5X 1/2 FPT	1	
CEHM2712F80HG	ML M27-1.5X 3/4 FPT	1	
CEHM331F80HG	ML M33-2.0 X 1FPT	1	

### ACRONYM KEY:

BSPT	BRITISH STRAIGHT PIPE THREAD
BSPP	BRITISH STRAIGHT PARALLEL PIPE THREAD
FPT	FEMALE PIPE THREAD
BOSS/MORT	MALE O-RING THREAD
FORT	FEMALE O-RING THREAD

### HEX NIPPLE

BRITISH STRAIGHT PIPE THREAD (BSPT)

Line: 704-75

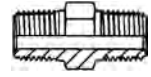

PART NUMBER	SIZE	QTY/BX	LIST PRICE
CEJ04FF33M	1/4-19 BSPT	1	
CEJ06FF33M	3/8-19 BSPT	1	
CEJ0604FF33M	3/8-19 X 1/4-19 BSPT	1	
CEJ08FF33M	1/2-14 BSPT	1	
CEJ0806FF33M	1/2-14 X 3/8-19 BSPT	1	
CEJ12FF33M	3/4-14 BSPT	1	
CEJ16FF33M	1-11 BSPT	1	
CEJ1612FF33M	1-11 X 3/4-14 BSPT	1	

### COUPLING

BRITISH STRAIGHT PARALLEL PIPE THREAD (BSPP)

Line: 704-76

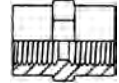

PART NUMBER	SIZE	QTY/BX	LIST PRICE
CEK04GG44M	1/4-19 BSPP	1	
CEK06GG44M	3/8-19 BSPP	1	
CEK08GG44M	1/2-14 BSPP	1	
CEK16GG44M	1-11 BSPP	1	

### BOSS TO BOSS O-RING THREAD

REDUCER/EXPANDER ADAPTER

Line: 704-99

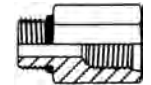

PART NUMBER	SIZE	QTY/BX	LIST PRICE
ARR46F50G5S	7/16-20 M X 9/16-18	2	
ARR63F50G5S	9/16-18 M X 3/8-24F0	5	
ARR64F50G5S	9/16-18 M X 7/16-20	2	
ARR68F50G5S	9/16-18 M X 3/4-16	2	
ARR86F50G5S	3/4-16 M X 9/16-18	2	
ARR810F50G5S	3/4-16 M X 7/8-14	2	
ARR106F50G5S	7/8-14 M X 9/16-18	2	
ARR108F50G5S	7/8-14 M X 3/4-16	2	
ARR1012F50G5S	7/8-14 M X 1 1/16-12	2	
ARR128F50G5S	1 1/16-12 M X 3/4-16	2	
ARR1210F50G5S	1 1/16-12 M X 7/8-14	2	
ARR168F50G5S	1 5/16-12 M X 3/4-16	2	
ARR1612F50G5S	1 5/16-12M X1 1/16-12	2	
ARR2016F50G5S	1 5/8-12ML X 1 5/16	2	
ARR2416F50G5S	1 7/8-12 X 1 5/16-12	1	

## MALE O-RING THRD/FEMALE PIPE THRD

ADAPTER

Line: 705-00

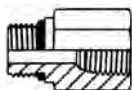

PART NUMBER	SIZE	QTY/BX	LIST PRICE
YNAC3269X4X4	1/4 X 1/4 6405-4-4)	5	
YNAC6405X54	5/16 X 1/4	1	
YNAC3269X64	3/8 X 1/4 (0502-6-4)	5	
YNAC3269X66	3/8 X 3/8 (0502-6-6)	5	
YNAC3269X68	3/8 X 1/2 (0502-6-8)	5	
YNAC3269X84	1/2 X 1/4 (0502-8-4)	5	
YNAC3269X86	1/2 X 3/8 (0502-8-6)	5	
YNAC3269X88	1/2 X 1/2 (0502-8-8)	5	
YNAC3269X104	5/8 X 1/4 (0502-10-4)	5	
YNAC3269X106	5/8 X 3/8 (0502-10-6)	5	
YNAC3269X108	5/8 X 1/2 (0502-10-8)	5	
YNAC32691012	5/8 X 3/4 (0502-10-12)	5	
YNAC3269X128	3/4 X 1/2 (0502-12-8)	1	
YNAC32691212	3/4 X 3/4 (0502-12-12)	1	
YNAC32691412	7/8 X 3/4 (0502-14-12)	1	
YNAC3269X168	1 X 1/2 (0502-16-8)	1	
YNAC32691612	1 X 3/4 (0502-16-12)	1	
YNAC32691616	1 X 1 (0502-16-16)	1	
YNAC3269X2016	1 1/4 X 1 (0502-20-16)	1	
YNAC3269X2020	1 1/4 X 1 1/4 (0502-20-20)	1	
YNAC3269X24	1 1/2 (0502-24-24)	1	
YNAC3269X2416	1 1/2 X 1	1	

## BOSS O-RING HEX FLUSH SOCKET PLUG

Line: 705-01



PART NUMBER	SIZE	QTY/BX	LIST PRICE
BDF3HP50N	3/8-24 (WH7238X3)	5	
BDF4HP50N	7/16-20 (WH7238X4)	5	
BDF5HP50N	1/2-20 (WH7238X5)	1	
BDF6HP50N	9/16-18 (WH7238X6)	5	
BDF8HP50N	3/4-16 (WH7238X8)	5	
BDF10HP50N	7/8-14 (WH7238X10)	5	
BDF12HP50N	1 1/16-12 (WH7238X12)	4	
BDF14HP50N	1 3/16-12 (WH7238X14)	4	
BDF16HP50N	1 5/16-12 (WH7238X16)	2	
BDF20HP50N	1 5/8-12 (WH7238X20)	2	
BDF2HP50N	-2 5/16-24 (7238X2)	5	

## BOSS O-RING HEX PLUG STEEL P50NS

ADAPTER

Line: 705-02

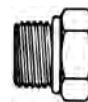

PART NUMBER	SIZE	QTY/BX	LIST PRICE
ARM2P50NS	5/16-24 (7237X2)	2	
ARM3P50NS	3/8-24 (7237X3)	2	
ARM4P50NS	7/16-20	2	
ARM5P50NS	1/2-20	2	
ARM6P50NS	9/16-18	2	
ARM8P50NS	3/4-16	2	
ARM10P50NS	7/8-14	2	
ARM12P50NS	1 1/16-12	2	
ARM14P50NS	1 3/16-12	2	
ARM20P50NS	1 1/4	1	
ARM16P50NS	1 5/16-12	2	
ARM24P50NS	1 1/2	1	

## MALE O-RING STRAIGHT THREAD UNION

ADAPTER

Line: 705-03

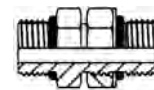

PART NUMBER	SIZE	QTY/BX	LIST PRICE
AXD505X4	1/4 (7/16-20)	5	
AXD505X6	3/8 (9/16-18)	5	
AXD505X8	1/2 (3/4-16)	5	
AXD505X10	5/8 (7/8-14)	2	
AXD505X12	3/4 (1 1/16-12)	2	

## MALE METRIC/FE STANDARD O-RING THREAD

CONVERSION ADAPTER

Line: 705-04

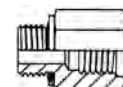

PART NUMBER	SIZE	QTY/BX	LIST PRICE
AXEF80HG5104	M10 X 7/16-20	5	
AXEF80HG5146	M14 X 9/16-18	5	
AXEF80HG5168	M16 X 3/4-16	4	
AXEF80HG52210	M22 X 7/8-14	4	
AXEF80HG52712	M27 X 1 1/16-12	2	

### EXPANDER PIPE THREAD

ADAPTER

Line: 705-05

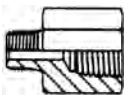

PART NUMBER	SIZE	QTY/BX	LIST PRICE
AXF201X2	1/8 X 1/8	5	
AXF201X42	1/4F X 1/8M	5	
AXF201X4	1/4 X 1/4	5	
AXF201X62	3/8F X 1/8M	5	
AXF201X64	3/8F X 1/4M	5	
AXF201X6	3/8 X 3/8	5	
AXF201X82	1/2F X 1/8M	5	
AXF201X84	1/2F X 1/4M	5	
AXF201X86	1/2F X 3/8M	5	
AXF201X8	1/2F X 1/2M	5	
AXF201X124	3/4F X 1/4M	4	
AXF201X128	3/4F X 1/2M	4	
AXF201X12	3/4 FPT X 3/4 MPT	2	
AXF201X168	1 F X 1/2M	4	
AXF201X1612	1 F X 3/4M C3209	4	
AXF201X16	1 FPT X 1MPT	2	
AXF201X2016	1 1/4 F X 1M C3209	2	
AXF201X20	1 1/4FPT X 1 1/4MPT	1	

### FORT/MALE PIPE THREAD

ADAPTER

Line: 705-06

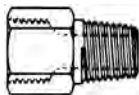

PART NUMBER	SIZE	QTY/BX	LIST PRICE
AXGC3239X6	3/8FORT X 3/8MPT	5	
AXGC3239X68	3/8FORT X 1/2 MPT	5	
AXGC3239X8	1/2 FORT X 1/2 MPT	5	
AXGC3239X86	1/2 FORT X 3/8 MPT	5	
AXGC3239X108	5/8 FORT X 1/2 MPT	4	

### ACRONYM KEY:

MPT	MALE PIPE THREAD
FPT	FEMALE PIPE THREAD
FORT	FEMALE O-RING THREAD
MORT	MALE O-RING THREAD

### MORT/MALE PIPE THREAD

ADAPTER

Line: 705-07



PART NUMBER	SIZE	QTY/BX	LIST PRICE
AXHC3249X42	1/4 MORT X 1/8 MPT	5	
AXHC3249X64	3/8 MORT X 1/4 MPT	5	
AXHC3249X66	3/8 MORT X 3/8 MPT	5	
AXHC3249X68	3/8 MORT X 1/2 MPT	4	
AXHC3249X8	1/2 MORT X 1/2 MPT	5	
AXHC3249X86	1/2 MORT X 3/8 MPT	5	
AXHC3249X108	5/8 MORT X 1/2 MPT	5	
AXHC3249X12	3/4 MORT X 3/4 MPT	4	
AXHC3249X16	1 MORT X 1 MPT	4	
AXHC3249X20	1 1/4MORT X 1 1/4MPT	1	
AXHC3249X24	1 1/2MORT X 1 1/2MPT	1	
AXHC3249X32	2 MORT X 2 MPT	1	

### MORT/MPT 90° ELBOW

Line: 705-08



PART NUMBER	SIZE	QTY/BX	LIST PRICE
AXJTF3569X4	1/4 MORT X 1/8 MPT	5	
AXJTF3569X5	5/16 MORT X 1/8 MPT	5	
AXJTF3569X6	3/8 MORT X 1/4 MPT	5	
AXJTF3569X8	1/2 MORT X 3/8 MPT	5	
AXJTF3569X10	5/8 MORT X 1/2 MPT	4	
AXJTF3569X12	3/4 MORT X 3/4 MPT	4	
AXJTF3569X14	7/8 MORT X 3/4 MPT	2	
AXJTF3569X16	1 MORT X 1MPT	2	
AXJTF3569X20	1 1/4 MORT X 1 1/4MPT	1	
AXJTF3569X24	1 1/2MORT X 1 1/2MPT	1	
AXJTF3569X32	2 MORT X 2 MPT	1	

### FEMALE JIC SWIVEL/MPT 90° ELBOW

Line: 705-09



PART NUMBER	SIZE	QTY/BX	LIST PRICE
AXKTF5406X4	1/4 F/JIC X 1/8 MPT	5	
AXKTF5406X44	1/4 F/JIC X 1/4 MPT	5	
AXKTF5406X6	3/8 F/JIC X 1/4 MPT	5	
AXKTF5406X8	1/2 F/JIC X 3/8 MPT	5	
AXKTF6501X8X8	1/2 F/JIC X 1/2 MPT	5	
AXKTF5406X10	5/8 F/JIC X 1/2 MPT	4	
AXKTF5406X12	3/4 F/JIC X 3/4 MPT	4	
AXKTF5406X16	1 F/JIC X 1 MPT	2	
AXKTF5406X20	1 1/4 F/JIC X 1 1/4 MPT	1	
AXKTF5406X24	1 1/2 F/JIC X 1 1/2 MPT	1	
AXKTF5406X32	2F/JIC X 2MPT	1	

### MPT SWIVEL/MPT 90° ELBOW

ADAPTER

Line: 705-10



PART NUMBER	SIZE	QTY/BX	LIST PRICE
AXL9435X44	1/4-18	4	
AXL9435X66	3/8-18	4	
AXL9435X88	1/2-14	4	

### MORT/FPT 90° ELBOW

ADAPTER

Line: 705-11

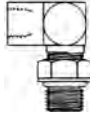

PART NUMBER	SIZE	QTY/BX	LIST PRICE
AYY6805X64	9/16-18 X 1/4	5	
AYY6805X66	9/16-18X 3/8	5	
AYY6805X86	3/4-16 X 3/8	4	
AYY6805X88	3/4-16 X 1/2	4	
AYY6805X108	7/8-14 X 1/2	2	
AYY6805X1212	1 1/16-12 X 3/4	2	
AYY6805X1616	1 5/16-12 X 1	1	

### MORT/FEMALE JIC SWIVEL 90° ELBOW

ADAPTER

Line: 705-13



PART NUMBER	SIZE	QTY/BX	LIST PRICE
AZD6809X44	7/16-20 X 1/4	2	
AZD6809X66	9/16-18 X 3/8	2	
AZD6809X88	3/4-16 X 1/2	2	
AZD6809X1010	7/8-14 X 5/8	1	
AZD6809X1212	1 1/16-12 X 3/4 JIC	1	
AZD6809X1616	1 5/16-12 X 1	1	
AZD6809X2020	1 5/8-12 X 1 1/4	1	

### MALE JIC/FEM JIC SWIVEL STRAIGHT CONN

ADAPTER

Line: 705-20



PART NUMBER	SIZE	QTY/BX	LIST PRICE
AZL6504X4	1/4	5	
AZL6504X6	3/8	5	
AZL6504X8	1/2	4	
AZL6504X10	5/8	2	
AZL6504X12	3/4	2	
AZL6504X16	1	1	
AZL6504X20	1 1/4	1	
AZL6504X24	1 1/2	1	

### FEM JIC SWIVEL/FPT STRAIGHT

ADAPTER

Line: 705-21

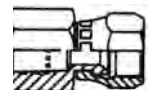

PART NUMBER	SIZE	QTY/BX	LIST PRICE
AZM6506X44	1/4 JIC X 1/4 FPT	5	
AZM6506X45	5/16 JIC X 1/4 FPT	5	
AZM6506X64	3/8 JIC X 1/4 FPT	5	
AZM6506X6SAE	3/8 SAE X 3/8 FPT	5	
AZM6506X66	3/8 FJ X 3/8 FP (C5256X)	5	
AZM6506X68	3/8 JIC X 1/2 FPT	5	
AZM6506X86	1/2 JIC X 3/8 FPT	4	
AZM6506X88	1/2 JIC X 1/2 FPT	4	
AZM6506X106	5/8 JIC X 3/8 FPT	2	
AZM6506X108	5/8 JIC X 1/2 FPT	2	
AZM6506X1012	5/8 JIC X 3/4 FPT	2	
AZM6506X128	3/4 JIC X 1/2 FPT	2	
AZM6506X1212	3/4 JIC X 3/4 FPT	2	
AZM6506X1412	7/8 JIC X 3/4 FPT	1	
AZM6506X1616	1 JIC X 1 FPT	1	
AZM6506X2020	1 1/4 JIC X 1 1/4 FPT	1	

### FPT/STRAIGHT MORT 90° ELBOW

HIGH PRESSURE ADAPTER

Line: 706-00

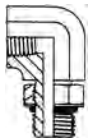

PART NUMBER	SIZE	QTY/BX	LIST PRICE
YPAC3459X8	1/2 X 3/8 (2502-8-6)	5	
YPAC3459X10	5/8 X 1/2 (2502-10-8)	5	
YPAC3459X12	3/4 X 3/4 (2502-12-12)	1	
YPAC3459X16	1 X 1 (2502-16-16)	1	

### LONG FPT/STRAIGHT MORT 90° ELBOW

HIGH PRESSURE ADAPTER

Line: 707-00

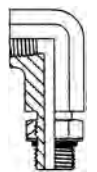

PART NUMBER	SIZE	QTY/BX	LIST PRICE
YRAC3469X8	1/2 X 3/8 (5502-8-6)	5	
YRAC3469X10	5/8 X 1/2 (5502-10-8)	5	
YRAC3469X12	3/4 X 3/4 (5502-12-12)	1	
YRAC3469X16	1 X 1 (5502-16-16)	1	

### MALE SEAL-LOK/MORT 90° ELBOW

STRAIGHT THREAD CONNECTOR

Line: 707-20



PART NUMBER	SIZE	QTY/BX	LIST PRICE
AZY4C50LO	9/16 S/L X 7/16 OR	5	
AZY46C50LO	9/16 S/L X 9/16 OR	5	
AZY64C50LO	11/16 S/L X 7/16 OR	5	
AZY6C50LO	11/16 S/L X 9/16 OR	5	
AZY68C50LO	11/16 S/L X 3/4 OR	5	
AZY610C50LO	11/16 S/L X 7/8 OR	5	
AZY86C50LO	13/16 S/L X 9/16 OR	4	
AZY8C50LO	13/16 S/L X 3/4 OR	4	
AZY810C50LO	13/16 S/L X 7/8 OR	4	
AZY812C50LO	13/16 S/L X 1 1/16 OR	4	
AZY108C50LO	1 S/L X 3/4 OR	2	
AZY10C50LO	1 S/L X 7/8 OR	2	
AZY1012C50LO	1 S/L X 1 1/16 OR	2	
AZY128C50LO	1 3/16 S/L X 3/4 OR	2	
AZY1210C50LO	1 3/16 S/L X 7/8 OR	2	
AZY12C50LO	1 3/16 S/L X 1 1/16 OR	2	
AZY1216C50LO	1 3/16 S/L X 1 5/16 OR	2	
AZY1612C50LO	1 7/16 S/L X 1 1/16 OR	1	
AZY16C50LO	1 7/16 S/L X 1 5/16 OR	1	
AZY1620C50LO	1 7/16 S/L X 1 5/8 OR	1	

### MALE SEAL-LOK/MORT

STRAIGHT THREAD CONNECTOR

Line: 707-21



PART NUMBER	SIZE	QTY/BX	LIST PRICE
AZZ4F50LO	9/16 S/L X 7/16 OR	5	
AZZ46F50LO	9/16 S/L X 9/16 OR	5	
AZZ48F50LO	9/16 S/L X 3/4 OR	5	
AZZ64F50LO	11/16 S/L X 7/16 OR	5	
AZZ6F50LO	11/16 S/L X 9/16 OR	5	
AZZ68F50LO	11/16 S/L X 3/4 OR	5	
AZZ610F50LO	11/16 S/L X 7/8 OR	5	
AZZ86F50LO	13/16 S/L X 9/16 OR	4	
AZZ8F50LO	13/16 S/L X 3/4 OR	4	
AZZ810F50LO	13/16 S/L X 7/8 OR	4	
AZZ812F50LO	13/16 S/L X 1 1/16 OR	4	
AZZ816F50LO	13/16 S/L X 1 5/16 OR	4	
AZZ108F50LO	1 S/L X 3/4 OR	2	
AZZ10F50LO	1 S/L X 7/8 OR	2	
AZZ1012F50LO	1 S/L X 1 1/16 OR	2	
AZZ128F50LO	1 3/16 S/L X 3/4 OR	2	
AZZ1210F50LO	1 3/16 S/L X 7/8 OR	2	
AZZ12F50LO	1 3/16 S/L X 1 1/16 OR	2	
AZZ1216F50LO	1 3/16 S/L X 1 5/16 OR	2	

(continued...)

### MALE SEAL-LOK/MORT (cont.)

STRAIGHT THREAD CONNECTOR

Line: 707-21

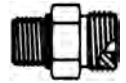

PART NUMBER	SIZE	QTY/BX	LIST PRICE
AZZ1612F50LO	1 7/16 S/L X 1 1/16 OR	1	
AZZ16F50LO	1 7/16 S/L X 1 5/16 OR	1	
AZZ1620F50LO	1 7/16 S/L X 1 5/8 OR	1	

### MALE SEAL-LOK/MORT 45° ELBOW

STRAIGHT THREAD CONNECTOR

Line: 707-22



PART NUMBER	SIZE	QTY/BX	LIST PRICE
BAB4V50LO	9/16 S/L X 7/16 OR	5	
BAB46V50LO	9/16 S/L X 9/16 OR	5	
BAB64V50LO	11/16 S/L X 7/16 OR	5	
BAB6V50LO	11/16 S/L X 9/16 OR	5	
BAB68V50LO	11/16 S/L X 3/4 OR	5	
BAB86V50LO	13/16 S/L X 9/16 OR	4	
BAB8V50LO	13/16 S/L X 3/4 OR	4	
BAB810V50LO	13/16 S/L X 7/8 OR	4	
BAB108V50LO	1 S/L X 3/4 OR	2	
BAB10V50LO	1 S/L X 7/8 OR	2	
BAB1012V50LO	1 S/L X 1 1/16 OR	2	
BAB1210V50LO	1 3/16 S/L X 7/8 OR	2	
BAB12V50LO	1 3/16 S/L X 1 1/16 OR	2	
BAB1216V50LO	1 3/16 S/L X 1 5/16 OR	2	
BAB1612V50LO	1 7/16 S/L X 1 1/16 OR	1	
BAB16V50LO	1 7/16 S/L X 1 5/16 OR	1	
BAB1620V50LO	1 7/16 S/L X 1 5/8 OR	1	



**CALL - 1 (800) 723-2826**

#### ACRONYM KEY:

MPT	MALE PIPE THREAD
FPT	FEMALE PIPE THREAD
MORT	MALE O-RING THREAD



## MALE SEAL-LOK/MALE PIPE THREAD

90° ELBOW ADAPTER

Line: 707-23

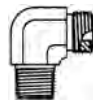

PART NUMBER	SIZE	QTY/BX	LIST PRICE
BAE4CLO	9/16 S/L X 1/8 MPT	5	
BAE44CLO	9/16 S/L X 1/4 MPT	5	
BAE6CLO	11/16 S/L X 1/4 MPT	5	
BAE66CLO	11/16 S/L X 3/8 MPT	5	
BAE68CLO	11/16 S/L X 1/2 MPT	5	
BAE8CLO	13/16 S/L X 3/8 MPT	4	
BAE88CLO	13/16 S/L X 1/2 MPT	4	
BAE812CLO	13/16 S/L X 3/4 MPT	4	
BAE10CLO	1 S/L X 1/2 MPT	2	
BAE128CLO	1 3/16 X 1/2 MPT	2	
BAE12CLO	1 3/16 S/L X 3/4 MPT	2	
BAE1216CLO	1 3/16 S/L X 1MPT	2	
BAE1612CLO	1 7/16 S/L X 3/4 MPT	1	
BAE16CLO	1 7/16 X 1 MPT	1	
BAE20CLO	1 11/16 S/L X 1 1/4MPT	1	
BAE24CLO	2 S/L X 1 1/2 MPT	1	

## MALE SEAL-LOK/MALE PIPE THREAD

STRAIGHT THREAD ADAPTER

Line: 707-24



PART NUMBER	SIZE	QTY/BX	LIST PRICE
BAF4FLO	9/16 S/L X 1/8 MPT	5	
BAF44FLO	9/16 S/L X 1/4 MPT	5	
BAF46FLO	9/16 S/L X 3/8 MPT	5	
BAF6FLO	11/16 S/L X 1/4 MPT	5	
BAF66FLO	11/16 S/L X 3/8 MPT	5	
BAF68FLO	11/16 S/L X 1/2 MPT	5	
BAF8FLO	13/16 S/L X 3/8 MPT	4	
BAF88FLO	13/16 S/L X 1/2 MPT	4	
BAF812FLO	13/16 S/L X 3/4 MPT	4	
BAF10FLO	1 S/L X 1/2 MPT	2	
BAF1012FLO	1 S/L X 3/4 MPT	2	
BAF128FLO	1 3/16 S/L X 1/2 MPT	2	
BAF12FLO	1 3/16 S/L X 3/4 MPT	2	
BAF1216FLO	1 3/16 S/L X 1 MPT	2	
BAF1612FLO	1 7/16 S/L X 3/4 MPT	1	
BAF16FLO	1 7/16 S/L X 1MPT	1	
BAF20FLO	1 11/16 S/L X 1 1/4MPT	1	
BAF24FLO	2 S/L X 1 1/2 MPT	1	

## FEMALE SWIVEL SEAL-LOK/MORT

90° ELBOW ADAPTER

Line: 707-25

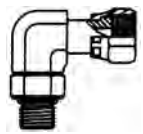

PART NUMBER	SIZE	QTY/BX	LIST PRICE
BAG4AEL60	9/16 SL X 7/16 MORT	5	
BAG6AEL60	11/16 SL X 9/16 MORT	5	
BAG8AEL60	13/16 SL X 3/4 MORT	4	
BAG10AEL60	1 SL X 7/8 MORT	2	
BAG12AEL60	1 3/16SL X 1 1/16MORT	2	
BAG16AEL60	1 7/16SL X 1 5/16MORT	2	
BAG20AEL60	1 11/16SL X 1 5/8ORT	1	
BAG24AEL60	2 SL X 1 7/8 MORT	1	

## FEMALE SWIVEL SEAL-LOK/MALE SEAL-LOK

90° ELBOW ADAPTER

Line: 707-26

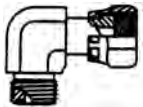

PART NUMBER	SIZE	QTY/BX	LIST PRICE
BAH4C6LO	9/16-18	5	
BAH6C6LO	11/16-16	5	
BAH8C6LO	13/16-16	4	
BAH10C6LO	1 1/4	2	
BAH12C6LO	1 3/16-12	2	
BAH16C6LO	1 7/16-12	2	
BAH20C6LO	1 11/16-12	1	
BAH24C6LO	2 1/2	1	

## MALE SEAL-LOK UNION

90° ELBOW ADAPTER

Line: 707-27



PART NUMBER	SIZE	QTY/BX	LIST PRICE
BAJ4ELO	9/16-18	5	
BAJ6ELO	11/16-16	5	
BAJ8ELO	13/16-16	5	
BAJ10ELO	1-14	2	
BAJ12ELO	1 3/16-12	2	
BAJ16ELO	1 7/16-12	2	
BAJ20ELO	1 11/16-12	1	
BAJ24ELO	2 1/2	1	

### ACRONYM KEY:

MPT	MALE PIPE THREAD
FPT	FEMALE PIPE THREAD
S/L	SEAL-LOK
MORT	MALE O-RING THREAD

### MALE SEAL-LOK UNION

ADAPTER

Line: 707-28

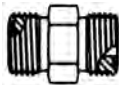

PART NUMBER	SIZE	QTY/BX	LIST PRICE
BAK4HLO	9/16-18	5	
BAK6HLO	11/16-16	5	
BAK64HLO	11/16-16 X 9/16-18	5	
BAK8HLO	13/16-16	5	
BAK86HLO	13/16-16 X 11/16-16	5	
BAK10HLO	1-14	2	
BAK108HLO	1-14 X 13/16-16	2	
BAK12HLO	1 3/16-12	2	
BAK16HLO	1 7/16-12	1	
BAK1612HLO	1 7/16-12 X 1 3/16-12	1	
BAK20HLO	1 11/16-12	1	
BAK24HLO	2 1/2	1	

### MALE SEAL-LOK UNION TEE

ADAPTER

Line: 707-29



PART NUMBER	SIZE	QTY/BX	LIST PRICE
BAP4JLO	9/16-18	5	
BAP6JLO	11/16-16	5	
BAP8JLO	13/16-16	4	
BAP10JLO	1-14	2	
BAP12JLO	1 3/16-12	2	
BAP16JLO	1 7/16-12	1	
BAP20JLO	1 11/16-12	1	
BAP24JLO	2 1/2	1	

### MALE SEAL-LOK X MALE JIC

ADAPTER

Line: 707-30

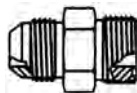

PART NUMBER	SIZE	QTY/BX	LIST PRICE
BAT4XHLO	9/16-18	2	
BAT6XHLO	11/16-16	2	
BAT8XHLO	13/16-16	2	
BAT10XHLO	1-14	2	
BAT12XHLO	1 3/16-12	1	
BAT16XHLO	1 7/16-12	1	
BAT20XHLO	1 11/16-12	1	
BAT24XHLO	2 1/2	1	

### FEMALE JIC SWIVEL/MALE SEAL-LOK

ADAPTER

Line: 707-31



PART NUMBER	SIZE	QTY/BX	LIST PRICE
BAY4LOHX6	7/16 X 9/16 S/L	2	
BAY6LOHX6	9/16 X 11/16 S/L	2	
BAY8LOHX6	3/4 X 13/16 S/L	2	
BAY10LOHX6	7/8 X 1 S/L	1	
BAY12LOHX6	1 1/16 X 1 3/16 S/L	1	
BAY16LOHX6	1 5/16 X 1 7/16 S/L	1	

### MALE JIC/FEMALE SEAL-LOK SWIVEL

STRAIGHT ADAPTER

Line: 707-32

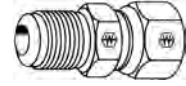

PART NUMBER	SIZE	QTY/BX	LIST PRICE
BAD4XHL6	7/16 X 9/16 S/L	2	
BAD6XHL6	9/16 X 11/16 S/L	2	
BAD8XHL6	3/4 X 13/16 S/L	2	
BAD10XHL6	7/8 X 1 S/L	1	
BAD12XHL6	1 1/16 X 1 3/16 S/L	1	
BAD16XHL6	1 5/16 X 1 7/16 S/L	1	
BAD20XHL6	1 5/8 X 1 11/16 S/L	1	

### SEAL-LOK TUBE NUT

ADAPTER

Line: 707-33



PART NUMBER	SIZE	QTY/BX	LIST PRICE
BBD4BL	9/16	5	
BBD6BL	11/16	5	
BBD8BL	13/16	5	
BBD10BL	1-14	5	
BBD12BL	1 3/16	5	
BBD16BL	1 7/16	4	
BBD20BL	1 11/16	2	
BBD24BL	2-12	2	

## FEMALE SEAL-LOK SWIVEL/MALE SEAL-LOK

STRAIGHT REDUCER

Line: 707-34



PART NUMBER	SIZE	QTY/BX	LIST PRICE
BBE64TRLO	11/16 X 9/16	5	
BBE86TRLO	13/16 X 11/16	5	
BBE106TRLO	1 X 11/16	5	
BBE108TRLO	1 X 13/16	5	
BBE126TRLO	13/16 X 11/16	5	
BBE128TRLO	13/16 X 13/16	5	
BBE1210TRLO	13/16 X 1	5	
BBE1610TRLO	17/16 X 1	2	
BBE1612TRLO	17/16 X 13/16	2	
BBE2012TRLO	1 11/16 X 1 3/16	2	
BBE2016TRLO	1 11/16 X 1 7/16	2	
BBE2416TRLO	2 X 1 7/16	1	
BBE2420TRLO	2 X 1 11/16	1	

## SEAL-LOK SWIVEL NUT RUN TEE

ADAPTER

Line: 707-35

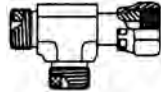

PART NUMBER	SIZE	QTY/BX	LIST PRICE
BHK4R6LOS	9/16 -4 S/L	2	
BHK6R6LOS	11/16 -6 S/L	2	
BHK8R6LOS	13/16 -8 S/L	2	
BHK10R6LOS	1 -10 S/L	2	
BHK12R6LOS	1 3/16 -12 S/L	1	
BHK16R6LOS	1 7/16 -16 S/L	1	
BHK20R6LOS	1 11/16 -20 S/L	1	
BHK24R6LOS	2 -24 S/L	1	

## SEAL-LOK SWIVEL NUT BRANCH TEE

ADAPTER

Line: 707-36

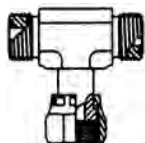

PART NUMBER	SIZE	QTY/BX	LIST PRICE
BHLS6L04	-4 9/16 S/L	4	
BHLS6L06	-6 11/16 S/L	4	
BHLS6L08	-8 13/16 S/L	2	
BHLS6L010	-10 1 S/L	2	
BHLS6L012	-12 1 3/16 S/L	2	
BHLS6L016	-16 1 7/16 S/L	2	
BHLS6L020	-20 1 11/16 S/L	1	
BHLS6L024	-24 2 S/L	1	

## SEAL-LOK/O-RING ON RUN TEE

ADAPTER

Line: 707-37

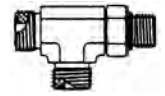

PART NUMBER	SIZE	QTY/BX	LIST PRICE
BHM4R50LOS	-4 S/L X -4 ORT	4	
BHM6R50LOS	-6 S/L X -6 ORT	4	
BHM8R50LOS	-8 S/L X -8 ORT	2	
BHM10R50LOS	-10 S/L X -10 ORT	2	
BHM12R50LOS	-12 S/L X -12 ORT	2	
BHM16R50LOS	-16 S/L X -16 ORT	1	
BHM20R50LOS	-20 S/L X -20 ORT	1	
BHM24R50LOS	-24 S/L X -24 ORT	1	

## SEAL-LOK HEX PLUG

ADAPTER

Line: 707-38



PART NUMBER	SIZE	QTY/BX	LIST PRICE
BHN4PNLOS	9/16 -4 S/L	5	
BHN6PNLOS	11/16 -6 S/L	5	
BHN8PNLOS	13/16 -8 S/L	5	
BHN10PNLOS	7/8 -10 S/L	5	
BHN12PNLOS	1 3/16 -12 S/L	5	
BHN16PNLOS	1 7/16 -16 S/L	2	
BHN20PNLOS	1 11/16 -20 S/L	2	
BHN24PNLOS	2 -24 S/L	2	

## SEAL-LOK HEX CAP

ADAPTER

Line: 707-39



PART NUMBER	SIZE	QTY/BX	LIST PRICE
BHP4FNLS	9/16 -4 SL	5	
BHP6FNLS	11/16 -6 SL	5	
BHP8FNLS	13/16 -8 SL	5	
BHP10FNLS	7/8 -10 S/L	2	
BHP12FNLS	1 3/16 -12 SL	2	
BHP16FNLS	1 7/16 -16 SL	2	
BHP20FNLS	1 11/16 -20 SL	1	
BHP24FNLS	2-12 -24 SL	1	

**HIGH PRESSURE STEEL FITTING O-RING**



Line: 708-00

PART NUMBER	SIZE	QTY/BX	LIST PRICE
YSA7629X1	1/16	10	
YSA7629X2	1/8	10	
YSA7629X3	3/16	10	
YSA7629X4	1/4 711509-1	10	
YSA7629X5	5/16 711509-2	10	
YSA7629X6	3/8 711509-3 7629	10	
YSA7629X7	7/16	10	
YSA711510X6	1/2 61/62 FLANGE TYPE	5	
YSA7629X8	1/2 711509-4	10	
YSA7629X10	5/8 711509-5	10	
YSA711510X5	3/4 61/62 FLANGE TYPE	5	
YSA7629X12	3/4 711509-6	10	
YSA7629X14	7/8	10	
YSA711510X4	1 61/62 FLANGE TYPE	5	
YSA7629X16	1 711509-7	10	
YSA711510X3	1 1/4 61/62 FLANGE	5	
YSA7629X20	1 1/4 711509-8	10	
YSA711510X2	1 1/2 61/62 FLANGE	5	
YSA7629X24	1 1/2 711509-9	10	
YSA711510X1	2 61/62 FLANGE TYPE	5	
YSA7629X32	2 711509-10	10	
YSA2011X4	-4 S/LOK 2-011/4629	20	
YSA2012X6	-6 S/LOK 2-012/4629	20	
YSA2014X8	-8 S/LOK 2-014/4629	20	
YSA2016X10	-10S/LOK 2-016/4629	20	
YSA2018X12	-12S/LOK 2-018/4629	20	
YSA2021X16	-16S/LOK 2-021/4629	10	
YSA2025X20	-20S/LOK 2-025/4629	10	
YSA2029X24	-24S/LOK 2-029/4629	10	

**MALE BSPT/MALE BSPP 30° MALE SEAT STRAIGHT ADAPTER**

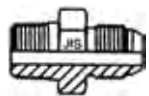

Line: 708-10

PART NUMBER	SIZE	QTY/BX	LIST PRICE
BRT44F3T4	1/4-19TP X 1/4-19PP	1	
BRT6F3T4	1/4-19TP X 3/8-19PP	1	
BRT46F3T4	3/8-19TP X 1/4-19PP	1	
BRT66F3T4	3/8-19TP X 3/8-19PP	1	
BRT8F3T4	3/8-19TP X 1/2-14PP	1	
BRT88F3T4	1/2-14TP X 1/2-14PP	1	
BRT12F3T4	3/4-14TP X 3/4-14PP	1	
BRT16F3T4	1-11TP X 1-11PP	1	

**MALE BSPT/MALE BSPP**

30° MALE SEAT ELBOW

Line: 708-11

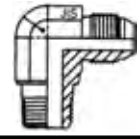

PART NUMBER	SIZE	QTY/BX	LIST PRICE
BRV44C3T4	1/4-19TP X 1/4-19PP	1	
BRV66C3T4	3/8-19TP X 3/8-19PP	1	
BRV88C3T4	1/2-14TP X 1/2-14PP	1	
BRV12C3T4	3/4-14TP X 3/4-14PP	1	
BRV16C3T4	1-11TP X 1-11PP	1	

**MALE BSPT/MALE BSPP**

30° MALE SEAT STRAIGHT FITTING

Line: 708-12

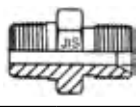

PART NUMBER	SIZE	QTY/BX	LIST PRICE
BRW44F3P4	1/4-19TP X 1/4-19PP	1	
BRW66F3P4	3/8-19TP X 3/8-19PP	1	
BRW88F3P4	1/2-14TP X 1/2-14PP	1	
BRW12F3P4	3/4-14TP X 3/4-14PP	1	
BRW16F3P4	1-11TP X 1-11PP	1	

**MALE BSPT/MALE BSPP JIS**

30° MALE SEAT - 90° ELBOW

Line: 708-13



PART NUMBER	SIZE	QTY/BX	LIST PRICE
BRX44C3P4	1/4-19TP X 1/4-19PP	1	
BRX66C3P4	3/8-19TP X 3/8-19PP	1	
BRX88C3P4	1/2-14TP X 1/2-14PP	1	
BRX12C3P4	3/4-14TP X 3/4-14PP	1	
BRX16C3P4	1-11TP X 1-11PP	1	

**MALE BSPT/MALE BSPP JIS**

30° MALE SEAT STRAIGHT FITTING

Line: 708-14

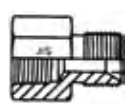

PART NUMBER	SIZE	QTY/BX	LIST PRICE
BRY44G3P4	1/4-19TP X 1/4-19PP	1	
BRY66G3P4	3/8-19TP X 3/8-19PP	1	
BRY88G3P4	1/2-14TP X 1/2-14PP	1	
BRY12G3P4	3/4-14TP X 3/4-14PP	1	
BRY16G3P4	1-11TP X 1-11PP	1	

**MALE BSPT/FEMALE BSPP 60° SWIVEL**

JIS STRAIGHT CONNECTOR

Line: 708-15



PART NUMBER	SIZE	QTY/BX	LIST PRICE
BRZ44F63P4	1/4-19 W/60° CONE	1	
BRZ66F63P4	3/8-19 W/60° CONE	1	
BRZ88F63P4	1/2-14 W/60° CONE	1	
BRZ12F63P4	3/4-14 W/60° CONE	1	
BRZ16F63P4	1-14 W/60° CONE	1	

## G63P4 FE-BSPT/FE BSPP SWV 24° JIS STR

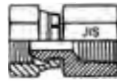

Line: 708-16

PART NUMBER	SIZE	QTY/BX	LIST PRICE
CDT44G63P4	F-BSPT/1/4-19/F-BSPP	1	
CDT66G63P4	F-BSPT/3/8-19/F-BSPP	1	
CDT88G63P4	F-BSPT/1/2-14/F-BSPP	1	
CDT12G63P4	F-BSPT/3/4-14/F-BSPP	1	
CDT16G63P4	F-BSPT/1-11/F-BSPP	1	

## GELR MLE BSPP/MLE METRIC 24° STRA (L)

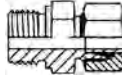

Line: 708-17

PART NUMBER	SIZE	QTY/BX	LIST PRICE
CDRGE6LRA3C	1/8-28PP X M12-1.5	1	
CDRGE10LRA3C	1/4-19PP X M16-1.5	1	
CDRGE8LRA3C	1/4-19PP/M14-1.5	1	
CDRGE12LRA3C	3/8-19PP X M18-1.5	1	
CDRGE8LR3/8	3/8-19PP/M14-1.5	1	
CDRGE14RA3C	1/2-14PP/M22-1.5HVY	1	
CDRGE15LRA3C	1/2-14PP X M22-1.5	1	
CDRGE18LRA3C	1/2-14PP X M26-1.5	1	
CDRGE22LRA3C	3/4-14PP X M30-2.0	1	
CDRGE28LRA3C	1-11PP X M36-2.0	1	
CDRGE35LRA3C	1 1/4-11PP X M45-2.0	1	
CDRGE42LRA3C	1 1/2-11PP X M52-2.0	1	

## GEREDL ELAS SEAL BSPP X MM 24° STRA (L)



Line: 708-18

PART NUMBER	SIZE	QTY/BX	LIST PRICE
CDVGE6LREDA3C	1/8-28PT/M12-1.5	1	
CDVGE10LREDA3	1/4-19/M16-1.5	1	
CDVGE8LREDA3C	1/4-19PT/M14-1.5	1	
CDVGE12LREDA3	3/8-19/M18-1.5	1	
CDVGE15LR3/8	3/8-19PT/M22-1.5	1	
CDVGE15LREDA3	1/2-14PT/M22-1.5	1	
CDVGE18LREDA3	1/2-14PT / M26-1.5	1	
CDVGE22LREDA3	3/4-14PT / M30-2.0	1	
CDVGE28LREDA3	1-11PT / M36-2.0	1	
CDVGE35LREDA3	1 1/4-11PT/M45-2.0	1	
CDVGE42LREDA3	1 1/2-11PT/M52-2.0	1	

## GEREDS BSPP/METRIC ELAS 24° CONE (S)



Line: 708-19

PART NUMBER	SIZE	QTY/BX	LIST PRICE
CDXGE6SREDA3C	1/4-19PT / M14-1.5	1	
CDXGE8SREDA3C	1/4-19PT / M16-1.5	1	
CDXGE10SREDA3	3/8-19PT / M18-1.5	1	
CDXGE12SREDA3	3/8-19PT / M20-1.5	1	
CDXGE14SREDA3	1/2-14PT / M22-1.5	1	
CDXGE16SREDA3	1/2-14PT / M24-1.5	1	
CDXGE20SREDA3	3/4-14PT / M30-2.0	1	
CDXGE25SREDA3	1-11PT / M36-2.0	1	
CDXGE30SREDA3	1 1/4-11 / M42-2.0	1	
CDXGE38SREDA3	1 1/2-11PT/M52-2.0	1	

## F640MX JIC SWVL/MLE BSPP

STRAIGHT ADAPTER



Line: 708-20

PART NUMBER	SIZE	QTY/BX	LIST PRICE
CDY4F640MX	-4JIC SWV X 1/8-28PP	1	
CDY44F640MX	-4JIC SWV X 1/4-19PP	1	
CDY54F640MX	-5JIC SWV X 1/4-19PP	1	
CDY6F640MX	-6JIC SWV X 1/4-19PP	1	
CDY66F640MX	-6JIC SWV X 3/8-19PP	1	
CDY8F640MX	-8JIC SWV X 3/8-19PP	1	
CDY10F640MX	-10JIC SWV/1/2-14PP	1	
CDY12F640MX	-12JIC SWV/3/4-14PP	1	
CDY16F640MX	-16JIC SWV/1-11 PP	1	
CDY20F640MX	-20JIC SWV/1/4-11PP	1	

## F680MX FE JIC SWVL/ML METRIC

STRAIGHT ADAPTER



Line: 708-21

PART NUMBER	SIZE	QTY/BX	LIST PRICE
CDZ10M22F680M	-10JIC SWV / M22-1.5	1	
CDZ12M27F680M	-12JIC SWV / M27-2.0	1	
CDZ16M33F680M	-16JIC SWV / M32-2.0	1	

## SEGMENTED FLARING TOOL

Line: 723-00



PART NUMBER	SIZE	QTY/BX	LIST PRICE
ZKAT1295	37° 1/2 CAP HVY DTY	1	
ZKAT1290	37° 5/8 CAP	1	

## SINGLE FLARING TOOL 3/16-1/2

Line: 724-00



PART NUMBER	SIZE	QTY/BX	LIST PRICE
ZKAT210	T-210	1	

**SOFT TUBE BENDING SPRING SET**



Line: 726-00

PART NUMBER	SIZE	QTY/BX	LIST PRICE
ZKAT200	1/4-1/2	1	

**SOFT TUBE BENDING SPRING SET**



Line: 727-00

PART NUMBER	SIZE	QTY/BX	LIST PRICE
ZKAT100	1/4-5/8	1	

**LEVER STYLE TUBE BENDING TOOLS**

Line: 728-00



PART NUMBER	SIZE	QTY/BX	LIST PRICE
ZKAT362	1/8 (#372)	1	
ZKAT363	3/16 (#373)	1	
ZKAT364	1/4 (#374)	1	
ZKAT365	5/16 (#T375)	1	
ZKAT366	3/8 (#376)	1	
ZKAT368	1/2 (#378)	1	
ZKAT3610	5/8 (#T3710)	1	
ZKAT3612	3/4 (#T3712)	1	

**TUBE BENDING SPRING**



Line: 729-00

PART NUMBER	SIZE	QTY/BX	LIST PRICE
ZKAT104	1/4	1	
ZKAT105	5/16	1	
ZKAT106	3/8	1	
ZKAT107	7/16	1	
ZKAT108	1/2	1	
ZKAT1010	5/8	1	

**NOTE: ALL TUBING & HOSE PRODUCTS ARE SOLD AND BOXED BY THE FOOT.**

**NYLON IM PSI TUBING**

NATURAL COLOR

Line: 748-00



PART NUMBER	SIZE	QTY/BX	LIST PRICE
EDBPT23002NA	1/8	100	
EDBPT23003NA	3/16 (NN-3-025)	100	
EDBPT23004NA	1/4 (NN-4-035)	100	
EDBPT23005NA	5/16 (NN-5-040)	100	
EDBPT23006NA	3/8 (NN-6-050)	100	
EDBPT23008NA	1/2 (NN-8-062)	100	

**NYLON IM PSI TUBING**

BLACK COLOR

Line: 748-01



PART NUMBER	SIZE	QTY/BX	LIST PRICE
EEBPT23002BK	1/8 (NB-02-016)	100	
EEBPT23003BK	3/16 (NB-03-025)	100	
EEBPT23004BK	1/4 (NB-04-035)	100	
EEBPT23005BK	5/16 (NB-05-040)	100	
EEBPT23006BK	3/8 (NB-06-050)	100	
EEBPT23008BK	1/2 (NB-08-062)	100	

**NYLON 2M PSI TUBING**

NATURAL COLOR

Line: 749-00



PART NUMBER	SIZE	QTY/BX	LIST PRICE
EFB4225N-231	1/8 (NNR-2-017)	100	
EFB4225N-346	3/16 NAT (NNR-03-024)	100	
EFB4225N-462	1/4 (NNR-4-035)	100	
EFB4225N-693	3/8 (NNR-06-048)	100	
EFB4225N8124	1/2 NAT (NNR-08-062)	100	

**NYLON 2M PSI TUBING**

BLACK COLOR

Line: 749-01



PART NUMBER	SIZE	QTY/BX	LIST PRICE
EGB4212B-231	1/8 (NBR-02-017)	100	
EGB4212B-346	3/16 BLACK (NBR-03-024)	100	
EGB4212B-462	1/4 BLACK (NBR-04-035)	100	
EGB4212B-693	3/8 BLACK (NBR-06-048)	100	
EGB4212B8124	1/2 BLACK (NBR-08-062)	100	

**POLYETHYLENE TUBING**

NATURAL COLOR - BULK ROLL

Line: 749-50



PART NUMBER	SIZE	QTY/BX	LIST PRICE
ANLPT24044NAT	1/4 (E-43-0500)	100	
ANLPT24005NAT	5/16 (E-53-0500)	100	
ANLPT24006NAT	3/8 (E-64-0500)	100	
ANLPT24008NAT	1/2 (E-86-0250)	100	
ANLPT24010NAT	5/8 (E-108-0100)	100	

## POLYETHYLENE TUBING

BLACK COLOR - BULK ROLL

Line: 749-51



PART NUMBER	SIZE	QTY/BX	LIST PRICE
ANMPT24044BLK	1/4 (EB-43-0500)	100	
ANMPT24005BLK	5/16 (EB-53-0500)	100	
ANMPT24006BLK	3/8 (EB-64-0500)	100	
ANMPT24008BLK	1/2 (EB-86-0250)	100	
ANMPT24010BLK	5/8 (EB-108-0100)	100	

## POLYETHYLENE TUBING

NATURAL COLOR

Line: 750-00



PART NUMBER	SIZE	QTY/BX	LIST PRICE
EHB22PN	1/8 NATURAL IMP	100	
EHB532PN	5/32 NATURAL IMP	100	
EHB33PN	3/16 NATURAL IMP	100	

## POLYETHYLENE TUBING

BLACK COLOR

Line: 750-01



PART NUMBER	SIZE	QTY/BX	LIST PRICE
EJB22PBL	1/8 BLACK IMP	100	
EJB33PBL	3/16 BLACK IMP	100	

## POLYETHYLENE TUBING

BLUE COLOR

Line: 750-03



PART NUMBER	SIZE	QTY/BX	LIST PRICE
EPBPT24005BU	5/16 BLUE .062 WALL	100	
EPBPT24006BU	3/8 BLUE	100	

## POLYETHYLENE TUBING

GREEN COLOR

Line: 750-04



PART NUMBER	SIZE	QTY/BX	LIST PRICE
ENBPT24044GN	1/4 GREEN (E43G-0500)	100	
ENBPT24006GN	3/8 GREEN	100	

## POLYETHYLENE TUBING

ORANGE COLOR

Line: 750-05



PART NUMBER	SIZE	QTY/BX	LIST PRICE
EMBPT24044OR	1/4 ORANGE (E43O-0500)	100	
EMBPT24006OR	3/8 ORANGE	100	

## POLYETHYLENE TUBING

RED COLOR

Line: 750-06



PART NUMBER	SIZE	QTY/BX	LIST PRICE
ELBPT24044RD	1/4 RED (E-43-R-0500)	100	
ELBPT24006RD	3/8 RED	100	

## POLYETHYLENE TUBING

YELLOW COLOR

Line: 750-08



PART NUMBER	SIZE	QTY/BX	LIST PRICE
EKBPT24044YW	1/4 YLW (E-43-Y-0500)	100	
EKBPT24006YW	3/8 YELLOW	100	

## GP PARFLEX GENERAL PURPOSE HOSE

THERMOPLASTIC COVER

Line: 751-00

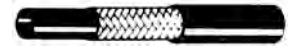

PART NUMBER	SIZE	QTY/BX	LIST PRICE
ERBGPH3BLK	3/16 ID BLACK	1	
ERBGPH3G	3/16 ID GRAY	1	
ERBGPH4BL	1/4 ID BLUE	1	
ERBGPH4G	1/4 ID GRAY	1	
ERBGPH4R	1/4 ID RED (GPH4R)	1	
ERBGPH4Y	1/4 ID YELLOW (GPH4Y)	1	
ERBGPH6BL	3/8 ID BLUE	1	
ERBGPH6BLK	3/8 ID BLACK (GPH6BLK)	1	
ERBGPH6R	3/8 ID RED	1	
ERBGPH6Y	3/8 ID YELLOW	1	
ERBGPH8BL	1/2 ID BLUE	1	
ERBGPH8G	1/2 ID GRAY	1	
ERBGPH8R	1/2 ID RED (GPH8R)	1	
ERBGPH8Y	1/2 ID YELLOW	1	
ESBGPH12R	3/4 ID BLACK COVER	1	

## NYLON J844 TRUCK HOSE TUBING

BLACK

Line: 752-00



PART NUMBER	SIZE	QTY/BX	LIST PRICE
EXBNT10002BK	1/8 BLACK (PFT-2A)	100	
EXBNT10004BK	1/4 BLACK (PFT-4A)	100	
EXBNT10006BK	3/8 BLACK (PFT-6B)	100	
EXBNT10008BK	1/2 BLACK (PFT-8B)	100	
EXBNT10010BK	5/8 BLACK (PFT-10B)	100	
EXBNT10012BK	3/4 BLACK (PFT-12B)	100	

**NOTE: ALL TUBING & HOSE PRODUCTS ARE SOLD AND BOXED BY THE FOOT.**

**NYLON J844 TRUCK HOSE TUBING**

BLUE

Line: 752-01



PART NUMBER	SIZE	QTY/BX	LIST PRICE
JFUNT10004BU	1/4 BLUE	100	
JFUNT10006BU	3/8 BLUE	100	
JFUNT10008BU	1/2 BLUE	100	

**NYLON J844 TRUCK HOSE TUBING**

GREEN

Line: 752-02



PART NUMBER	SIZE	QTY/BX	LIST PRICE
FABNT10004GN	1/4 GREEN	100	
FABNT10006GN	3/8 GREEN	100	
FABNT10008GN	1/2 GREEN	100	
FABNT10010GN	5/8 GREEN	100	

**NYLON J844 TRUCK HOSE TUBING**

ORANGE

Line: 752-03



PART NUMBER	SIZE	QTY/BX	LIST PRICE
EZBNT10004OR	1/4 ORANGE	100	
EZBNT10006OR	3/8 ORANGE	100	
EZBNT10008OR	1/2 ORANGE	100	

**NYLON J844 TRUCK HOSE TUBING**

WHITE

Line: 752-04



PART NUMBER	SIZE	QTY/BX	LIST PRICE
JGUNT10004WH	1/4 WHITE	100	
JGUNT10006WH	3/8 WHITE	100	
JGUNT10008WH	1/2 WHITE	100	

**NYLON J844 TRUCK HOSE TUBING**

RED

Line: 752-05



PART NUMBER	SIZE	QTY/BX	LIST PRICE
EYBNT10004RD	1/4 RED	100	
EYBNT10006RD	3/8 RED	100	
EYBNT10008RD	1/2 RED	100	
EYBNT10010RD	5/8 RED	100	

**NYLON J844 TRUCK HOSE TUBING**

YELLOW

Line: 752-06



PART NUMBER	SIZE	QTY/BX	LIST PRICE
JHUNT10004YW	1/4 YELLOW	100	
JHUNT10006YW	3/8 YELLOW	100	
JHUNT10008YW	1/2 YELLOW	100	

**POLYVINYL CHLORIDE TUBING**



Line: 753-00

PART NUMBER	SIZE	QTY/BX	LIST PRICE
FEBPT20004NA	1/4 OD X .126 ID	100	
FEBPT20044NA	1/4 OD X .170 ID	100	
FEBPT20005NA	5/16 OD X .188 ID	100	
FEBPT20006NA	3/8 OD X .251 ID	100	
FEBPT20008NA	1/2 OD X .376 ID	100	
FEBPT20010NA	5/8 OD X .501 ID	100	
FEBPT20012NA	3/4 OD X .562 ID	100	
FEBPT20016NA	1 OD X 3/4 ID	100	

**FOOD GRADE BRAIDED PVC TUBING**

FDA APPROVED

Line: 753-02



PART NUMBER	SIZE	QTY/BX	LIST PRICE
AZX28790	1/4 ID X 1/2 OD	25	
AZX28800	5/16ID X 9/16 OD	25	
AZX28810	3/8 ID X 5/8 OD	25	
AZX29561	1/2 ID X .719 OD	25	
AZX28762	5/8 ID X .875 OD	25	
AZX28870	3/4 ID X 1OD	25	
AZX28850	1ID X 1 1/2 OD	25	
AZX28860	1 1/4 ID X 1 3/4 OD	25	
AZX28865	1 1/2 ID X 1.929 OD	25	
AZX32	2 ID X 2 1/2 OD	25	
AZX32HP	2 X 2 1/2 133PSI WP	100	

**TRUCK - EQUIPMENT HEATER HOSE**

50' ROLL

Line: 754-01



PART NUMBER	SIZE	QTY/BX	LIST PRICE
FFB06350	1/2 ID	50	
FFB1825	1/2 ID BLACK	50	
FFBHHS10	5/8 SILICONE	50	
FFB05908	5/8 ID	50	
FFB1826	5/8 ID BLACK	50	
FFBHHS12	3/4 SILICONE	50	
FFB05910	3/4 ID	50	
FFB1827	3/4 ID BLACK	50	
FFB05916	1 ID	50	

**NOTE: ALL TUBING & HOSE PRODUCTS ARE SOLD AND BOXED BY THE FOOT.**



## H057 HOSE

WEATHERHEAD - LOW PRESSURE HOSE 1500

Line: 756-00



PART NUMBER	SIZE	QTY/BX	LIST PRICE
FGBH05703	-3 ID 25048	25	
FGBH05704	-4 ID 25060	25	
FGBH05705	-5 ID 25078	25	
FGBH05706	-6 ID 25088	25	
FGBH05707	7/16 ID 25106	25	

## WINDSHIELD WIPER VACUUM HOSE

SAE J1037

Line: 756-02



PART NUMBER	SIZE	QTY/BX	LIST PRICE
BER3338	3/32 FOR 5/64 BARB	50	
BER3339	7/64 FOR 1/8 BARB	50	
BER3340	5/32 FOR 3/16 BARB	50	
BER3341	7/32 FOR 1/4 BARB	50	
BERAVH250	1/4ID RED SILICONE	25	
BER3342	9/32 FOR 5/16 BARB	50	
BERAVH312	5/16ID RED SILICONE	25	

## PUSH-ON HOSE H101

LOW PRESSURE

Line: 758-00



PART NUMBER	SIZE	QTY/BX	LIST PRICE
FJBH10104	-4 ID 831-4	50	
FJBH10105	-5 ID	50	
FJBH10106	-6 ID 831-6	50	
FJBH10108	-8 ID 831-8	50	
FJBH10110	-10 ID 831-10	25	
FJBH10112	-12 ID 831-12	25	

## H338 AIR BRAKE TRUCK HOSE

W/ SERR FITT

Line: 759-00



PART NUMBER	SIZE	QTY/BX	LIST PRICE
FKBH33806RL	3/8 ID 250' RL N26R	50	
FKBH33808RL	1/2 ID 250' RL	50	

## H017 COLO-CRIMP HOSE

FOR U-SERIES FITTINGS - MED PRESSURE

Line: 760-00



PART NUMBER	SIZE	QTY/BX	LIST PRICE
FLBH01704	-4 ID	50	
FTBH36605	-5 ID	1	
FLBH01706	-6 ID	50	
FLBH01708	-8 ID	25	
FLBH01712	-12 ID	25	
FLBH01716	1 ID	25	
FLBH01720	1 1/4 ID	25	

## H017 COLO-CRIMP HOSE

MED PRESSURE - FOR U-SERIES FITTINGS

Line: 760-00



PART NUMBER	SIZE	QTY/BX	LIST PRICE
FPBH16604	-4 ID SS25-4-RL	1	
FPBH16605	-5 ID SS25-5	1	
FPBH16606	-6 ID SS25-6-RL	1	
FPBH16608	-8 ID SS25-8-RL	1	
FPBH16610	-10 ID SS25-10-RL	1	
FPBH16612	-12 ID SS25-12	1	
FPBH16616	-16 SS25-16	1	
FPBH16620	-20 SS25-20	1	

## H069 1-WIRE FIBER COVER HOSE

MED PRESSURE - FOR 247 SERIES FITTINGS

Line: 764-00



PART NUMBER	SIZE	QTY/BX	LIST PRICE
FRBH06904	-4 ID 201-4-RL	1	
FRBH06905	-5 ID 201-5-RL	1	
FRBH06906	-6 ID 201-6-RL	1	
FRBH06908	-8 ID 201-8-RL	1	
FRBH06910	-10 ID 201-10-RL	1	
FRBH06912	-12 ID 201-12-RL	1	
FRBH06916	-16 ID 201-16-RL	1	
FRBH06920	-20 ID 201-20	1	
FRBH06924	-24 201-24	1	
FRBH06932	-32 201-32	1	

## H169 1-WIRE HOSE

MED PRESSURE - FOR 247 SERIES FITTINGS

Line: 764-01



PART NUMBER	SIZE	QTY/BX	LIST PRICE
JKUH16904	-4 225-4-RL	1	
JKUH16905	-5 225-5	1	
JKUH16906	-6 225-6-RL	1	
JKUH16908	-8 225-8-RL	1	
JKUH16910	-10 255-10-RL	1	
JKUH16912	-12 225-12-RL	1	
JKUH16916	-16 225-16	1	
JKUH16920	-20 225-20	1	
JKUH16924	-24 225-24	1	
JKUH16932	-32 225-32	1	

**NOTE: ALL TUBING & HOSE PRODUCTS ARE SOLD AND BOXED BY THE FOOT.**

### H366 LP GAS HOSE

MEDIUM PRESSURE - FOR 247 SERIES FITTINGS

Line: 766-00



PART NUMBER	SIZE	QTY/BX	LIST PRICE
FTBH36606	-6 ID SS25UL-6-RL	1	
FTBH36608	-8 ID SS25UL-8	1	

### WIRE COVER HYDRAULIC HOSE

MED PRESSURE - FOR 43 SERIES CRIMP FITTINGS

Line: 768-03



PART NUMBER	SIZE	QTY/BX	LIST PRICE
AUP421WCX4	-4 1/4ID X 5/8 OD	1	
AUP421WCX6	-6 3/8ID X .74 OD	1	
AUP421WCX8	-8 1/2 ID X .86 OD	1	
AUP421WCX12	-12 3/4 ID X 1.15 OD	1	

### ABRASION RESIST HYDRAULIC HOSE

HIGH PRESSURE - FOR SERIES 43 FITTINGS

Line: 772-50



PART NUMBER	SIZE	QTY/BX	LIST PRICE
BAZ451TCX4	1/4 ID (451TC)	1	
BAZ451TCX8	1/2 ID -8 TUFF/COVER	1	
BAZ451ARX10	5/8 ID -10 SIZE	1	
BAZ451ARX12	3/4 ID -12 SIZE	1	
BAZ451TCX16	1ID -16 TUFF/COVER	1	
BAZ451ARX20	1 1/4 ID -20 SIZE	1	

### PARKER #436 100/R2 HIGH PRESSURE FUEL HOSE

HIGH PRESSURE - FOR SERIES 43 FITTINGS

Line: 772-51



PART NUMBER	SIZE	QTY/BX	LIST PRICE
BBX436X6	3/8 ID 4000PSI BLUE	1	
BBX436X8	1/2ID 3500PSI BLUE	1	
BBX436X10	5/8ID 2750PSI BLUE	1	
BBX436X12	3/4ID 2250PSI BLUE	1	
BBX436X16	1ID 2000PSI BLUE	1	

### HI/ABRASIVE 4/WIRE COMPACT HOSE

HIGH PRESSURE - FOR SERIES 43 FITTINGS

Line: 772-52



PART NUMBER	SIZE	QTY/BX	LIST PRICE
BBY341X6	3/8 ID 4500 PSI	1	
BBY341X8	1/2 ID 4000 PSI	1	
BBY341X12	3/4 ID 3000 PSI	1	
BBY341X16	1ID 3000 PSI	1	
BBY341X20	1 1/4 ID 2500 PSI	1	

**NOTE: ALL TUBING & HOSE PRODUCTS ARE SOLD AND BOXED BY THE FOOT.**

### PARKER #302 CRIMP/REUSEABLE HOSE

HIGH PRESSURE - FOR SERIES 43 FITTINGS

Line: 773-01

(#301 IS NOW #302)



PART NUMBER	SIZE	QTY/BX	LIST PRICE
AGF301X4	-4 1/4 ID (WHH425)	1	
AGF301X6	-6 3/8 ID (WHH425)	1	
AGF301X8	-8 1/2 ID (WHH425)	1	
AGF301X10	-10 5/8 ID (WHH425)	1	
AGF301X12	-12 3/4 ID (WHH425)	1	
AGF301X16	-16 1 ID (WHH425)	1	
AGF301X20	-20 1 1/4 ID 301-20	1	
AGF301X24	-24 1 1/2 (WHH425)	1	
AGF301X32	-32 2 (WHH425)	1	

### PARKER #381 CRIMP TYPE HI-PRES HOSE

HIGH PRESSURE - FOR SERIES 43 FITTINGS

Line: 773-03



PART NUMBER	SIZE	QTY/BX	LIST PRICE
AGH381X4	-4 1/4 ID	1	
AGH381X6	-6 3/8 ID	1	
AGH381X8	-8 1/2 ID 381-8	1	
AGH381X10	-10 5/8 ID 381-10	1	
AGH381X12	-12 3/4 ID 381-12	1	
AGH381X16	-16 1 ID 381-16	1	
AGH381X20	-20 1 1/4 ID 381-20	1	
AGH381X24	-24 1 1/2 381-24	1	
AGH381X32	-32 2 381-32	1	

### PARKER #881 CRIMP TYPE HOSE

LOW PRESSURE - FOR SERIES 43 FITTINGS

Line: 773-04



PART NUMBER	SIZE	QTY/BX	LIST PRICE
AGJ881X12	-12 3/4 ID	1	
AGJ881X16	-16 1 ID	1	
AGJ881X20	-20 1 1/4 ID	1	
AGJ881X24	-24 1 1/2 ID	1	
AGJ881X32	-32 2 ID	1	

### PARFLEX 510C MED/HIGH PRESSURE HOSE

FOR SERIES 55 FITTINGS - THERMOPLASTIC

Line: 773-06



PART NUMBER	SIZE	QTY/BX	LIST PRICE
AGL550HX3	-3 3/16 ID BLACK	1	
AGL550HX4	-4 1/4 ID BLACK	1	
AGL550HX5	-5 5/16 ID BLACK	1	
AGL550HX6	-6 3/8 ID BLACK	1	
AGL550HX8	-8 1/2 ID BLACK	1	
AGL550HX12	-12 3/4 ID BLACK	1	
AGL550HX16	-16 1 ID BLACK	1	

## PARFLEX 518C ORNG MED/HI-PRESSURE HOSE

NON CONDUCTIVE - FOR 55 SERIES FITTINGS

Line: 773-07



PART NUMBER	SIZE	QTY/BX	LIST PRICE
AGM518CX2	-2 1/8 ID ORANGE	50	
AGM518CX4	-4 1/4 ID ORANGE	1	
AGM518CX6	-6 3/8 ID ORANGE	1	
AGM518CX8	-8 1/2 ID ORANGE	1	

## PARFLEX 520N HI-PRESSURE HOSE - BLACK

FOR 55 SERIES FITTINGS

Line: 773-08



PART NUMBER	SIZE	QTY/BX	LIST PRICE
AGN520NX3	-3 3/16 ID	1	
AGN520NX4	-4 1/4 ID	1	
AGN520NX5	-5 5/16 ID	1	
AGN520NX6	-6 3/8 ID	1	
AGN520NX8	-8 1/2 ID	1	

## PARFLEX 550H TWN/LN 100R7 BLACK HOSE

FOR 55 SERIES FITTINGS

Line: 773-11



PART NUMBER	SIZE	QTY/BX	LIST PRICE
BJR550HX44	-4 1/4 ID MED PRES.	1	
BJR550HX55	-5 5/16 ID MED PRES.	1	
BJR550HX66	-6 3/8 ID MED PRES.	1	
BJR550HX88	-8 1/2 ID MED PRES.	1	

## 919 TEFLON STAIN/STEEL BRAIDED HOSE

FOR 90/91 SERIES FITTINGS

Line: 773-13



PART NUMBER	SIZE	QTY/BX	LIST PRICE
AGX919X4	-4 1/4 ID (WHH243)	1	
AGX919X5	-5 5/16 ID (WHH243)	1	
AGX919X6	-6 3/8 ID (WHH243)	1	
AGX919X8	-8 1/2 ID (WHH243)	1	
AGX919X10	-10 5/8 ID (WHH243)	1	
AGX919X12	-12 3/4 ID (WHH243)	1	
AGX919X16	-16 1 ID (WHH243)	1	
AGX919X20	-20 1 1/4 ID (WHH243)	1	

## PARFLEX #590 WIRE BRAID HYDRAULIC HOSE

Line: 773-16



PART NUMBER	SIZE	QTY/BX	LIST PRICE
CBM590X4	1/4(-4) 5M PSI #55	1	
CBM590X6	3/8(-6) 4M PSI #55FIT	1	
CBM590X8	1/2(-8) 3.5M PSI #55	1	
CBM590X10	5/8(-10) 3M PSI #58	1	
CBM590X12	3/4(-12) 2.25M PSI #58	1	
CBM590X16	1(-16) 2M PSI #58FIT	1	

## CRIMP 77C 100R12 4/W HOSE

VERY HIGH PRESSURE - FOR 71 SERIES FITTINGS

Line: 773-20



PART NUMBER	SIZE	QTY/BX	LIST PRICE
AUY77C6	-6 3/8 ID	1	
AUY77C8	-8 1/2 ID	1	
AUY77C10	-10 5/8 ID (#77C)	1	
AUY77C12	-12 3/4 ID (#772)	1	
AUY77C16	-16 1 ID (#772)	1	
AUY77C20	-20 1 1/4 ID (#772)	1	
AUY77C24	-24 1 1/2 ID (#772)	1	
AUY77C32	-32 2 ID (#772)	1	

## 78C SERIES ULTRA HI-PRESSURE HOSE

FOR 78 SERIES FITTINGS

Line: 773-21



PART NUMBER	SIZE	QTY/BX	LIST PRICE
BXK78C12	-12(3/4) (100R13/5MPsi)	1	
BXK78C16	-16(1) (100R13/5M PSI)	1	
BXK78C20	-20(1-1/4) (100R13/5M#)	1	
BXK78C24	-24(1-1/2) (100R13/5M#)	1	
BXK78C32	-32(2) (100R13/5MPsi)	1	

## 471ST HYDRAULIC HOSE SUPER TUFF COVER

FOR 43 SERIES FITTINGS

Line: 773-22



PART NUMBER	SIZE	QTY/BX	LIST PRICE
CBY471ST4	-4 1/4 ID	50	
CBY471ST6	-6 3/8 ID	1	
CBY471ST8	-8 1/2 ID	1	
CBY471ST10	-10 5/8 ID	1	
CBY471ST12	-12 3/4 ID	1	
CBY471ST16	-16 1 ID	1	

## PARKRIMP SPRING GUARD

FOR HOSE 301, 304, AND 381

Line: 774-03



PART NUMBER	SIZE	QTY/BX	LIST PRICE
AJTSG066	1/4 ID	10	
AJTSG084	3/8 ID	10	
AJTSG097	1/2 ID	10	
AJTSG106	5/8 ID	10	
AJTSG122	3/4 ID	10	
AJTSG131	-12 3/4 ID 77C/772	10	
AJTSG155	1 ID	10	
AJTSG209	1 1/4 ID	10	

**NOTE: ALL TUBING & HOSE PRODUCTS ARE SOLD AND BOXED BY THE FOOT.**

### AEROFLEX AIR HOSE ASSM 1/4 MPT E/E

300LB. WORKING PRESSURE

Line: 775-10



PART NUMBER	SIZE	QTY/BX	LIST PRICE
CCG06BH	3/8ID YELLOW BULK HOSE	1	
CCG06025YEL	3/8ID X 25FT 300# WP	1	
CCG06050YEL	3/8ID X 50FT 300# WP	1	
CCG06100YEL	3/8ID X 100FT 300# WP	1	

### 2-BRAID H105 ALL PURPOSE AIR HOSE

RED COVER

Line: 776-00



PART NUMBER	SIZE	QTY/BX	LIST PRICE
GFBH10504	1/4ID X 19/32OD	50	
GFBH10506	3/8ID X 23/32OD	50	
GFBH10508	1/2ID X 7/8OD	50	
GFBH10510	5/8ID X 10D	50	
GFBH10512	3/4ID X 1 5/32OD	50	
GFBH10516	1 ID X 1 7/16 OD	50	
GFBH10524	1 1/2ID X 2 1/32OD	50	

### PVC WATER DISCHARGE HOSE (FLAT)

BLUE COVER

Line: 776-03



PART NUMBER	SIZE	QTY/BX	LIST PRICE
AYV12BL	3/4ID .048 WALL	1	
AYV16BL	1 ID .052 WALL	1	
AYV20BL	1 1/4ID .056 WALL	1	
AYV24BL	1 1/2 .059 WALL	1	
AYV32BL	2 ID .059 WALL	1	
AYV40BL	2 1/2ID .059 WALL	1	
AYV48BL	3ID .063 WALL	1	
AYV64BL	4ID .067 WALL	1	
AYV96BL	6ID .075 WALL	1	
AYV40RD	2 1/2ID .091 WALL	1	

### COPPER TUBING

Line: 777-00



PART NUMBER	SIZE	QTY/BX	LIST PRICE
GGB02	1/8	50	
GGB532	5/32	25	
GGB03	3/16	50	
GGB04	1/4	50	
GGB05	5/16	50	
GGB06	3/8	50	
GGB08	1/2	50	
GGB10	5/8	50	
GGB12	3/4	50	
GGB14	7/8	50	

### 20 SERIES FEMALE COUPLER P/H

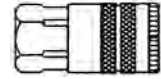

Line: 790-00

PART NUMBER	SIZE	QTY/BX	LIST PRICE
AVCB23A	1/4BODY 1/8-27 BRASS	5	
AVCB23	1/4BODY 1/4-18 BRASS	5	
AVCB23N	1/4 BODY X 1/4-18 BRASS	5	
AVCUC304F-4	1/4 BODY 1/4-18 NPSF	2	
AVCB23E	1/4BODY 3/8-18 BRASS	5	
AVC25C	3/8BODY 1/4-18 S/S	5	
AVCB25	3/8BODY 3/8-18 BRASS	5	
AVC25	3/8BODY 3/8-18 S/S	5	
AVC25F	3/8BODY 1/2-14 S/S	5	
AVC17E	1/2BODY 3/8-18 S/S	5	
AVCB17	1/2BODY 1/2-14 BRASS	5	
AVC17	1/2BODY 1/2-14 S/S	5	
AVC17G	1/2BODY 3/4-14 S/S	5	

### 20 SERIES MALE COUPLER P/H



Line: 791-00

PART NUMBER	SIZE	QTY/BX	LIST PRICE
ATCB22A	1/4BODY 1/8-27 BRASS	5	
ATCB22	1/4BODY 1/4-18 BRASS	5	
ATCB22N	1/4 BODY X 1/4-18 BRASS	5	
ATCU304M-4	1/4 BODY 1/4-18 NPTF	2	
ATCB22E	1/4BODY 3/8-18 BRASS	5	
ATC24C	3/8BODY 1/4-18 S/S	5	
ATCB24	3/8BODY 3/8-18 BRASS	5	
ATC24	3/8BODY 3/8-18 S/S	5	
ATC24F	3/8BODY 1/2-14 S/S	5	
ATCB16	1/2BODY 1/2-14 BRASS	5	
ATC16	1/2BODY 1/2-14 S/S	5	
ATC16E	1/2BODY 3/8-18 S/S	5	
ATC16G	1/2BODY 3/4-14 S/S	5	



CALL - 1 (800) 723-2826

## 20 SERIES FEMALE NIPPLE P/H

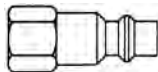

Line: 792-00

PART NUMBER	SIZE	QTY/BX	LIST PRICE
AUCH1C	1/4BODY 1/8-27 S/S	5	
AUCBH3C	1/4BODY 1/4-18 BRASS	5	
AUCH3C	1/4BODY 1/4-18 S/S	5	
AUCH3CE	1/4BODY 3/8-18 S/S	5	
AUCH1E	3/8BODY 1/4-18 S/S	5	
AUCBH3E	3/8BODY 3/8-18 BRASS	5	
AUCH3E	3/8BODY 3/8-18 S/S	5	
AUCH3EF	3/8BODY 1/2-14 S/S	5	
AUCH1F	1/2BODY 3/8-18 S/S	5	
AUCBH3F	1/2BODY 1/2-14 BRASS	5	
AUCH3F	1/2BODY 1/2-14 S/S	5	
AUCH3FG	1/2BODY 3/4-14 S/S	5	
AUCH3GF	3/4BODY 1/2-14 S/S	5	
AUCH3G	3/4BODY 3/4-14 S/S	1	
AUCH3GJ	3/4BODY 1-11 1/2 S/S	1	

## 20 SERIES MALE NIPPLE P/H

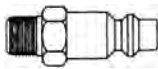

Line: 793-00

PART NUMBER	SIZE	QTY/BX	LIST PRICE
AWCH0C	1/4BODY 1/8-27 S/S	5	
AWCBH2C	1/4BODY 1/4-18 BRASS	5	
AWCH2C	1/4BODY 1/4-18 S/S	5	
AWCSH2C	1/4BODY 1/4-18STAIN/ S/S	5	
AWCH2CE	1/4BODY 3/8-18 S/S	5	
AWCH00E	3/8BODY 1/8-27 S/S	5	
AWCH0E	3/8BODY 1/4-18 S/S	5	
AWCBH2E	3/8BODY 3/8-18 BRASS	5	
AWCH2E	3/8BODY 3/8-18 S/S	5	
AWCH2EF	3/8BODY 1/2-14 S/S	5	
AWCH0F	1/2BODY 3/8-18 S/S	5	
AWCBH2F	1/2BODY 1/2-14 BRASS	5	
AWCH2F	1/2BODY 1/2-14 S/S	5	
AWCH2FG	1/2BODY 3/4-14 S/S	5	
AWCH2GF	3/4BODY 1/2-14 S/S	1	
AWCBH2G	3/4BODY 3/4-14 BRASS	1	
AWCH2G	3/4BODY 3/4-14 S/S	1	
AWCH2GJ	3/4BODY 1-11 1/2 S/S	1	

## 20 SERIES HOSE BARB COUPLER P/H

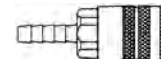

Line: 794-00

PART NUMBER	SIZE	QTY/BX	LIST PRICE
AEDB203B	1/4BODY 1/4BARB BRASS	1	
AEDB204B	1/4BODY 5/16BRB BRASS	1	
AEDB205B	1/4BODY 3/8BARB BRASS	1	
AED245B	3/8BODY 3/8BARB S/S	1	
AED246B	3/8BODY 1/2BARB S/S	1	
AED165B	1/2BODY 3/8BARB S/S	1	
AED166B	1/2BODY 1/2BARB S/S	1	
AED167B	1/2BODY 3/4BARB S/S	1	

## 20 SERIES HOSE BARB NIPPLE P/H

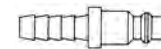

Line: 795-00

PART NUMBER	SIZE	QTY/BX	LIST PRICE
AEEH8C	1/4BODY 1/4BARB S/S	1	
AEEH8CD	1/4BODY 5/16BARB ST	1	
AEEH9C	1/4BODY 3/8BARB S/S	5	
AEEH5E	3/8BODY 3/8BARB S/S	1	
AEEH6E	3/8BODY 1/2BARB S/S	1	
AEEH4F	1/2BODY 3/8BARB S/S	1	
AEEH5F	1/2BODY 1/2BARB S/S	1	
AEEH5FG	1/2BODY 3/4BARB S/S	1	
AEEH5GF	3/4BODY 1/2BARB S/S	1	
AEBBH5G	3/4BODY 3/4BARB BRASS	1	
AEEH5G	3/4BODY 3/4BARB S/S	1	
AEEH5GJ	3/4BODY 1BARB S/S	1	

## 20 SERIES PUSH LOK COUPLER P/H

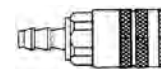

Line: 796-00

PART NUMBER	SIZE	QTY/BX	LIST PRICE
AEFB203BP	1/4BODY 1/4BARB BRASS	1	
AEFB205BP	1/4BODY 3/8BARB BRASS	1	
AEF245BP	3/8BODY 3/8BARB S/S	1	
AEF165BP	1/2BODY 3/8BARB S/S	1	
AEF166BP	1/2BODY 1/2BARB S/S	1	

## 20 SERIES PUSH LOK NIPPLES P/H

Line: 797-00

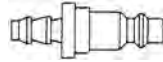

PART NUMBER	SIZE	QTY/BX	LIST PRICE
AEGBH8CP	1/4BODY 1/4BARB BRASS	1	
AEGH8CP	1/4BODY 1/4BARB S/S	1	
AEGH9CP	1/4BODY 3/8BARB S/S	1	
AEGH4EP	3/8BODY 1/4BARB S/S	1	
AEGH5EP	3/8BODY 3/8BARB S/S	1	
AEGH6EP	3/8BODY 1/2BARB S/S	1	
AEGH4FP	1/2BODY 3/8BARB S/S	1	
AEGH5FP	1/2BODY 1/2BARB S/S	1	

## 20 SERIES HOSE FITTING COUPLING P/H

Line: 798-00



PART NUMBER	SIZE	QTY/BX	LIST PRICE
AEHB22C3	1/4ID X 1/20D BRASS	1	
AEHB22C5	1/4ID X 9/160D BRASS	1	
AEHB22C6	1/4ID X 5/80D BRASS	1	
AEHB22E8	3/8ID X 11/160D BRASS	5	
AEH24E8	3/8ID X 11/160D BRASS	1	

## 20 SERIES HOSE FITTING NIPPLE P/H

Line: 799-00

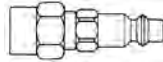

PART NUMBER	SIZE	QTY/BX	LIST PRICE
AEJH8CC3	1/4ID X 1/20D S/S	1	
AEJH8CC5	1/4ID X 9/160D S/S	1	
AEJH8CC6	1/4ID X 5/80D S/S	1	
AEJH7EE7	3/8ID X 21/320D S/S	1	
AEJH8CE10	3/8ID X 3/40D S/S	1	
AEJH8CE6	3/8 ID X 5/8 OD	5	
AEJH8CE8	3/8 ID X 11/160D RHF	5	

## 10 SERIES FEMALE COUPLER P/H

Line: 823-00

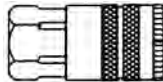

PART NUMBER	SIZE	QTY/BX	LIST PRICE
GKDB13A	1/4BODY 1/8-27 BRASS	5	
GKDB13	1/4BODY 1/4-18BRASS	5	
GKDB13E	1/4BODY 3/8-18 BRASS	5	
GKD15C	3/8BODY 1/4-18 S/S	5	
GKDB15	3/8BODY 3/8-18 BRASS	5	
GKD15	3/8BODY 3/8-18 S/S	5	
GKD15F	3/8BODY 1/2-14 S/S	5	
GKD17E	1/2BODY 3/8-18 S/S	5	
GKDB17	1/2BODY 1/2-14 BRASS	5	
GKD17	1/2BODY 1/2-14 S/S	5	
GKD17G	1/2BODY 3/4-14 S/S	5	

## 10 SERIES MALE COUPLER P/H

Line: 823-01

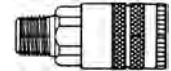

PART NUMBER	SIZE	QTY/BX	LIST PRICE
GLDB12A	1/4BODY 1/8-27 BR	5	
GLDB12	1/4BODY 1/4-18 BR	5	
GLDB12E	1/4BODY 3/8-18 BR	5	
GLD14C	3/8BODY 1/4-18 S/S	5	
GLDB14	3/8 BODY 3/8-18 BRASS	5	
GLD14	3/8BODY 3/8-18 S/S	5	
GLD14F	3/8BODY 1/2-14 S/S	5	
GLD16E	1/2BODY 3/8-18 S/S	5	
GLDB16	1/2BODY 1/2-14 BRASS	5	
GLD16	1/2BODY 1/2-14 S/S	5	
GLD16G	1/2BODY 3/4-14 S/S	5	

## 10 SERIES FEMALE NIPPLE P/H

Line: 824-00

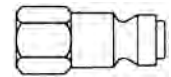

PART NUMBER	SIZE	QTY/BX	LIST PRICE
GMD1C	1/4BODY 1/8-27 S/S	5	
GMDB3C	1/4BODY 1/4-18 BRASS	5	
GMD3C	1/4BODY 1/4-18- S/S	5	
GMD3CE	1/4BODY 3/8-18 S/S	5	
GMD1E	3/8 BODY 1/4-18 S/S	5	
GMD3E	3/8BODY 3/8-18 S/S	5	
GMD1F	1/2BODY 3/8-18 S/S	5	
GMD3F	1/2BODY 1/2-14 S/S	5	
GMDH3FG	1/2BODY 3/4-14 S/S	5	

## 10 SERIES MALE NIPPLE P/H

Line: 825-00

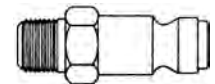

PART NUMBER	SIZE	QTY/BX	LIST PRICE
GND0C	1/4BODY 1/8-27 S/S	5	
GNDB2C	1/4BODY 1/4-18 BRASS	5	
GND2C	1/4BODY 1/4-18 S/S	5	
GND2CE	1/4BODY 3/8-18 S/S	5	
GND0E	3/8BODY 1/4-18 S/S	5	
GND2E	3/8BODY 3/8-18 S/S	5	
GND0F	1/2BODY 3/8-18 S/S	5	
GND2F	1/2BODY 1/2-14 S/S	5	
GNDH2FG	1/2BODY 3/4-14 S/S	5	

## 10 SERIES HOSE BARB COUPLER P/H

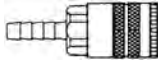

Line: 826-00

PART NUMBER	SIZE	QTY/BX	LIST PRICE
GPDB103B	1/4BODY 1/4BARB BR	5	
GPDB105B	1/4BODY 3/8BARB BRASS	5	
GPD145B	3/8BODY 3/8BARB S/S	1	
GPD146B	3/8BODY 1/2BARB S/S	1	
GPD165B	1/2BODY 3/8BARB S/S	1	
GPD166B	1/2BODY 1/2BARB S/S	1	
GPD167B	1/2BODY 3/4BARB S/S	1	

## 10 SERIES HOSE BARB NIPPLE P/H

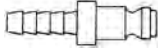

Line: 827-00

PART NUMBER	SIZE	QTY/BX	LIST PRICE
GVD8C	1/4BODY 1/4BARB S/S	1	
GVD9C	1/4BODY 3/8BARB S/S	1	
GVD5E	3/8BODY 3/8BARB S/S	1	
GVDH5FG	1/2BODY 3/4BARB S/S	1	
GVD5F	1/2BODY 1/2BARB S/S	1	

## 10 SERIES PUSH LOK COUPLER P/H

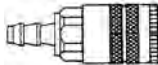

Line: 828-00

PART NUMBER	SIZE	QTY/BX	LIST PRICE
GUDB103BP	1/4BODY 1/4 BARB BR	1	
GUDB105BP	1/4BODY 3/8BARB BR	1	
GUD145BP	3/8BODY 3/8BARB S/S	1	
GUD165BP	1/2BODY 3/8BARB S/S	1	
GUD166BP	1/2BODY 1/2BARB S/S	1	

## 10 SERIES PUSH LOK NIPPLES P/H

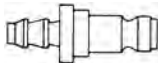

Line: 829-00

PART NUMBER	SIZE	QTY/BX	LIST PRICE
GSD8CP	1/4BODY 1/4BARB S/S	1	
GSD9CP	1/4BODY 3/8BARB S/S	1	
GSD5EP	3/8BODY 3/8BARB S/S	1	
GSDH4FP	1/2BODY 3/8BARB S/S	1	
GSDH5FP	1/2BODY 1/2BARB S/S	1	

## 60 SERIES QK COUPLER P/H

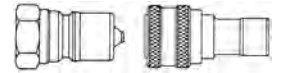

Line: 853-00

PART NUMBER	SIZE	QTY/BX	LIST PRICE
JGZBH260	1/4 X 1/4 FP CPL BRASS	1	
JGZH262	1/4 X 1/4 FPT CPL	1	
JGZH263	1/4 X 1/4 FPT NIP	1	
JGZH262T6	1/4 X 9/16-18ORT CPL	1	
JGZH263T6	1/4 X 9/16-18ORT NIP	1	
JGZH3-62	3/8 FPT COUPLER/BODY	1	
JGZH3-63	3/8 FPT NIPPLE/BODY	1	
JGZH362T8	3/8 X 3/4-16ORT CPL	1	
JGZH363T8	3/8 X 3/4-16 ORT NIP	1	
JGZH368	3/8 FPT COUPLER/STEAM	1	
JGZH369	3/8 FPT NIPPLE/STEAM	1	
JGZH462	1/2 FPT COUPLER/BODY	1	
JGZH463	1/2 FPT NIPPLE/BODY	1	
JGZH462T10	1/2 X 7/8-14ORT CPL	1	
JGZH463T20	1/2 X 7/8-14ORT NIP	1	
JGZBH660	3/4 X 3/ 4FP CPL BRASS	1	
JGZH662	3/4 FPT COUPLER/BODY	1	
JGZH663	3/4 FPT NIPPLE/BODY	1	
JGZH662T12	3/4- 1-1/16-12ORTCPL	1	
JGZH663612	3/4 X 1 1/16-12ORTNIP	1	
JGZH862	1 X 1 FPT CPL	1	
JGZH863	1 X 1 FPT NIP	1	
JGZH862T16	1 X 1 15/16-12ORTCPL	1	
JGZH863T16	1 X 1 15/16-12ORTNIP	1	

## 6600 P/H HYD HI-PRES COUPLER

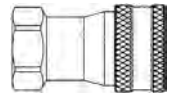

Line: 853-10

PART NUMBER	SIZE	QTY/BX	LIST PRICE
AXX6601X42	1/4 BODY X 1/8 FPT	1	
AXX6601X44	1/4 BODY X 1/4 FPT	1	
AXX6601X66	3/8 BODY X 3/8 FPT	1	
AXX6608X66	3/8 BODY X 9/16 FORT	1	
AXX6601X810	1/2 BODY X 1/2 FPT	1	
AXX6601X1210	1/2 BODY X 3/4 FPT	1	
AXX6608X810	1/2 BD X 3/4-16FORT	1	
AXX6608X1010	1/2 BODY X 7/8 FORT	1	
AXX6608X1210	1/2 BDY X 1 1/16 FORT	1	
AXX6601X1212	3/4 BODY X 3/4 FPT	1	
AXX6608X1212	3/4 BODY X 1 1/16-12FORT	1	
AXX6601X1616	1 BODY X 1 FPT	1	
AXX6608X1616	1 BODY X 1 5/16 FORT	1	

**6600 SERIES P/H HYD HI-PRES NIPPLE**

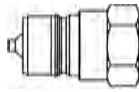

Line: 853-11

PART NUMBER	SIZE	QTY/BX	LIST PRICE
AXY6602X42	1/4 BODY 1/8 FPT	1	
AXY6602X44	1/4 BODY X 1/4 FPT	1	
AXY6602X66	3/8 BODY X 3/8 FPT	1	
AXY6610X66	3/8 BODY X 9/16 FORT	1	
AXY6602X810	1/2 BODY X 1/2 FPT	1	
AXY6602X1210	1/2 BODY X 3/4 FPT	1	
AXY6610X1010	1/2 BODY X 7/8 FORT	1	
AXY6610X1210	1/2 BODY X 1 1/16 FORT	1	
AXY6610X810	1/2 BODY X 3/4-16FORT	1	
AXY6602X1212	3/4 BODY X 3/4 FPT	1	
AXY6610X1212	3/4 BODY X 1 1/16-12FORT	1	
AXY6602X1616	1 BODY X 1 FPT	1	
AXY6610X1616	1 BODY X 1 5/16 FORT	1	

**50 SERIES FEMALE COUPLER P/H**

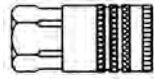

Line: 863-00

PART NUMBER	SIZE	QTY/BX	LIST PRICE
HAD53AX	1/4 BODY 1/8-27 BRASS	1	
HADB53	1/4-18 BRASS	1	
HADB53E	3/8-18 BRASS	1	

**50 SERIES MALE COUPLER**

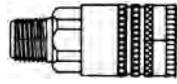

Line: 864-00

PART NUMBER	SIZE	QTY/BX	LIST PRICE
HADB52	1/4BODY 1/4-18BRASS	1	
HADB52E	1/4BODY 3/8-18 BRASS	1	

**50 SERIES FEMALE NIPPLE P/H**

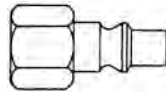

Line: 865-00

PART NUMBER	SIZE	QTY/BX	LIST PRICE
HBDA2C	1/4BODY 1/4-18 S/S	5	
HBDA3C	1/4BODY 1/4-18 S/S	5	

**50 SERIES MALE NIPPLE P/H**

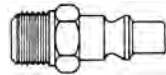

Line: 866-00

PART NUMBER	SIZE	QTY/BX	LIST PRICE
HBDA8CP	1/4BODY 1/4BARB S/S	1	
HBDA2C	1/4BODY 1/4-18 S/S	5	

**50 SERIES PUSH LOK COUPLER P/H**

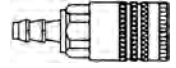

Line: 867-00

PART NUMBER	SIZE	QTY/BX	LIST PRICE
HADB503BP	1/4BODY 1/4BARB BRS	1	
HADB505BP	1/4BODY 3/8BARB BRS	1	

**50 SERIES HOSE BARB NIPPLE P/H**

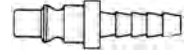

Line: 869-00

PART NUMBER	SIZE	QTY/BX	LIST PRICE
HBDA8C	1/4BODY 1/4BARB	1	
HBDA9CX	1/4BODY 3/8 BARB	1	

**70 SERIES 1/4 P/H FEM NPT COUPLER**

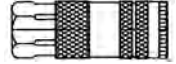

Line: 870-00

PART NUMBER	SIZE	QTY/BX	LIST PRICE
HCDB73	1/4-18 BRASS	1	

**70 SERIES 1/4 P/H MALE NPT COUPLER**

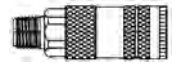

Line: 871-00

PART NUMBER	SIZE	QTY/BX	LIST PRICE
HCDB72	1/4-18 BRASS	1	

**70 SERIES 1/4 P/H FEM NPT NIPPLE**

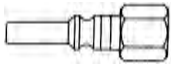

Line: 872-00

PART NUMBER	SIZE	QTY/BX	LIST PRICE
HDD-L3C	1/4-18	1	

**70 SERIES 1/4 P/H MALE NPT NIPPLE**

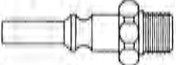

Line: 873-00

PART NUMBER	SIZE	QTY/BX	LIST PRICE
HDD-L2C	1/4-18	1	



**CALL - 1 (800) 723-2826**



### 30 SERIES FEMALE COUPLER P/H

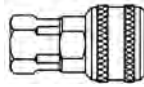

Line: 874-00

PART NUMBER	SIZE	QTY/BX	LIST PRICE
ADFB33A	1/4BODY 1/8-27BRASS	1	
ADFB33	1/4BODY 1/4-18BRASS	1	
ADFB33E	1/4BODY 3/8-18BRASS	1	
ADFB35C	3/8BODY 1/4-18BRASS	1	
ADFB35	3/8BODY 3/8-18BRASS	1	
ADFB35SL	3/8B 3/8FP SLV LOCK	1	
ADFB35F	3/8BODY 1/2-14BRASS	1	
ADFB37E	1/2BODY 3/8-18BRASS	1	
ADFB37	1/2BODY 1/2-14BRASS	1	
ADFB37G	1/2BODY 3/4-14BRASS	1	
ADFB39F	3/4BODY 1/2-14BRASS	1	
ADFB39	3/4BODY 3/4-14BRASS	1	
ADFB39J	3/4BODY 1-11 1/2BRS	1	

### 30 SERIES MALE COUPLER P/H

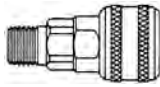

Line: 874-01

PART NUMBER	SIZE	QTY/BX	LIST PRICE
ADGB32A	1/4BODY 1/8-27BRASS	1	
ADGB32	1/4BODY 1/4-18BRASS	1	
ADGB32E	1/4BODY 3/8-18BRASS	1	
ADGB32ESL	1/4B 3/8MP SLV LOCK	1	
ADGB34C	3/8BODY 1/4-18BRASS	1	
ADGB34	3/8BODY 3/8-18BRASS	1	
ADGB34SL	3/8B 3/8MP SLV LOCK	1	
ADGB34F	3/8BODY 1/2-14BRASS	1	
ADGB36E	1/2BODY 3/8-18BRASS	1	
ADGB36	1/2BODY 1/2-14BRASS	1	
ADGB36G	1/2BODY 3/4-14BRASS	1	
ADGB38F	3/4BODY 1/2-14BRASS	1	
ADGB38	3/4BODY 3/4-14BRASS	1	
ADGB38J	3/4BODY 1-11 1/2BRS	1	

### 30 SERIES HOSE BARB COUPLER P/H

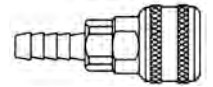

Line: 874-02

PART NUMBER	SIZE	QTY/BX	LIST PRICE
ADHB303B	1/4 BODY 1/4 BRASS	1	
ADHB305B	1/4 BODY 3/8 BRASS	1	
ADHB345B	3/8 BODY 3/8 BRASS	1	
ADHB346B	3/8 BODY 1/2 BRASS	1	
ADHB366B	1/2 BODY 1/2 BRASS	1	
ADHB367B	1/2 BODY 3/4 BRASS	1	
ADHB386B	3/4 BODY 1/2 BRASS	1	
ADHB387B	3/4 BODY 3/4 BRASS	1	
ADHB388B	3/4 BODY 1 BRASS	1	

### 30 SERIES PUSH LOK COUPLER P/H

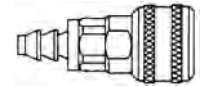

Line: 874-03

PART NUMBER	SIZE	QTY/BX	LIST PRICE
ADJB303BP	1/4 BODY 1/4 BRASS	1	
ADJB305BP	1/4 BODY 3/8 BRASS	1	
ADJB345BP	3/8 BODY 3/8 BRASS	1	
ADJB366BP	1/2 BODY 1/2 BRASS	1	

### EZ MATE FEMALE COUPLER P/H



Line: 874-06

PART NUMBER	SIZE	QTY/BX	LIST PRICE
ADLEZ304F4L	1/4BODY 1/4-18 S/S	1	
ADLEZ304F6L	1/4BODY 3/8-18 S/S	1	
ADLEZ306F6L	3/8BODY 3/8-18 S/S	1	
ADLEZ306F8L	3/8BODY 1/2-14 S/S	1	
ADLEZ308F12L	1/2BODY 3/4-14 S/S	1	
ADLEZ308F8L	1/2BODY 1/2-14 S/S	1	
ADLEZ312F12L	3/4BODY 3/4-14 S/S	1	
ADLEZ312F16L	3/4BODY 1-11 1/2 ST	1	

### PARKER FULL FLOW BLOW GUN



Line: 875-00

PART NUMBER	SIZE	QTY/BX	LIST PRICE
AXC-400	1/4 FPT 415N BUTTON	1	
AXC-401	1/4 FPT 410N LEVER	1	

**2 WAY VALVE LEVER BLOW GUN**



Line: 875-01

PART NUMBER	SIZE	QTY/BX	LIST PRICE
AXC-401VA	1/4FPT X 1/4FPT 410	1	

**PARKER CONTROL FLOW BLOW GUN**



Line: 876-00

PART NUMBER	SIZE	QTY/BX	LIST PRICE
AXC-409	1/4 FPT 410SV	1	

**PARKER 1/4 CONTROL FLOW BLOW GUN**



Line: 877-00

PART NUMBER	SIZE	QTY/BX	LIST PRICE
AXC18302	1/4FPT W/4 EXT	1	
AXC40630B	1/4 FPT BUTTON 415S	1	
AXC40730B	1/4 FPT LEVER 410S	1	

**PARKER AIR LINE FILTER**



Line: 877-01

PART NUMBER	SIZE	QTY/BX	LIST PRICE
JBV150M	1/4FPT X 1/4MPT	1	

**AIR KING HOSE BARB END CLAMP**



PLATED MALLEABLE STEEL

Line: 879-10

PART NUMBER	SIZE	QTY/BX	LIST PRICE
ALZ06CD	3/8 HS 11/16-7/8 O.D	2	
ALZ08A4	1/2 HS 1-1 3/16 O.D	2	
ALZ12A9	3/4HS 1 1/8-1 5/16OD	2	
ALZ16A14	1HS 1 1/2-1 13/16OD	2	

**AIR KING HOSE BARB END COUPLER**



MALLEABLE IRON

Line: 879-11

PART NUMBER	SIZE	QTY/BX	LIST PRICE
AMUAMH	3/8	10	
AMUAM1	1/2	10	
AMUAM6	3/4	5	
AMUAM11	1	5	

**AIR KING MPT END COUPLER**



MALLEABLE IRON

Line: 879-12

PART NUMBER	SIZE	QTY/BX	LIST PRICE
AMVAMB	3/8	10	
AMVAMB1	1/4	10	
AMVAM2	1/2	10	
AMVAM7	3/4	5	
AMVAM12	1	5	

**AIR KING FPT END COUPLER**



MALLEABLE IRON

Line: 879-13

PART NUMBER	SIZE	QTY/BX	LIST PRICE
AMWAMC	3/8	10	
AMWAMC1	1/4	10	
AMWAM3	1/2	10	
AMWAM8	3/4	5	
AMWAM13	1	5	
AMWUF200	2-4-LUG	1	

**AIR KING COUPLING PRODUCTS**

SAFETY CLIPS & SEALING WASHERS



Line: 879-14

PART NUMBER	SIZE	QTY/BX	LIST PRICE
AMXAWR4	RUBBER 3/8-1 SZ	25	
AMX215C	SAFETY CLIP	10	

**P/H 4000 SERIES PIONEER**

HYDRAULIC COUPLER

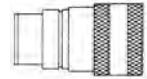

Line: 880-00

PART NUMBER	SIZE	QTY/BX	LIST PRICE
ADV4050X2	1/4 X 1/4-18 4050-2	1	
ADV4050T6	1/4 X 9/16-18 ORT	1	
ADV4050X3	3/8 X 3/8-18 4050-3	1	
ADV4050X4	1/2 X 1/2-14 4050-4	1	
ADV4050X15	1/2 BODY 3/4-16 S/S	1	
ADV4050X5	1/2 BODY 3/4-14 S/S	1	
ADV4050X16	1/2 BODY 7/8-14 S/S	1	
ADV4150X5	3/4 X 3/4-14 4150-5	1	
ADV4050X6P	1 X 1-11 1/2 4050-6P	1	

**P/H 4000 SERIES PIONEER HYD NIPPLE**

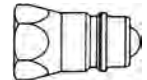

Line: 880-01

PART NUMBER	SIZE	QTY/BX	LIST PRICE
ADW4010X2	1/4 X 1/4-18 4010-2	1	
ADW4010T6	1/4 X 9/16-18 ORT	1	
ADW4010X3	3/8 X 3/8-18 4010-3	1	
ADW8010X4	1/2 X 1/2-14 8010-4	1	
ADW8010X15	1/2 BODY 3/4-16 S/S	1	
ADW8010X5	1/2 BODY 3/4-14 S/S	1	
ADW8010X16	1/2 BODY 7/8-14 S/S	1	
ADW4110X5	3/4 X 3/4-14 4110-5	1	
ADW4010X6P	1X1-11 1/2 4010-6P	1	

## DUST PLUG

PH 4000 SERIES

Line: 880-02



PART NUMBER	SIZE	QTY/BX	LIST PRICE
ADX5205X2M	1/4 BODY RUBBER	1	
ADX5205X3	3/8 BODY RUBBER	1	
ADX5005X4	1/2 BODY STEEL	1	
ADX5205X4M	1/2 BODY RUBBER	1	
ADX5205X6	3/4 BODY RUBBER	1	

## DUST CAP

PH 4000 SERIES

Line: 880-03



PART NUMBER	SIZE	QTY/BX	LIST PRICE
ADY5209X2M	1/4 BODY RUBBER	1	
ADY5209X3	3/8 BODY RUBBER	1	
ADY5009X4	1/2 BODY STEEL	1	
ADY5209X4M	1/2 BODY RUBBER	1	
ADY5209X6	3/4 BODY RUBBER	1	

## HYDRAULIC COUPLER

PH 5000 SERIES

Line: 880-06

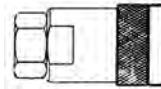

PART NUMBER	SIZE	QTY/BX	LIST PRICE
ADZ5050X4	1/2 X 1/2-14 5050-4	1	

## HYDRAULIC NIPPLE

PH 5000 SERIES

Line: 880-07

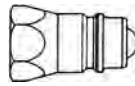

PART NUMBER	SIZE	QTY/BX	LIST PRICE
AEB8010X4	1/2 X 1/2-14 8010-4	1	

## NON SPILL HYDRAULIC COUPLER

FF SERIES - PARKER

Line: 880-10

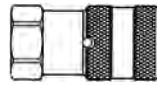

PART NUMBER	SIZE	QTY/BX	LIST PRICE
JPUFF2514FP	1/4-18 FPT X 1/4 BODY	1	
JPUFF3716FP	3/8-18 FPT X 3/8 BODY	1	
JPUFF3718FP	1/2-14 FPT X 3/8 BODY	1	
JPUFF5018FP	1/2-14 FPT X 1/2 BODY	1	
JPUFF2516FO	9/16-18FORT X 1/4BODY	1	
JPUFF5112FP	3/4-14FPT X 3/4 BODY	1	
JPUFF3718FO	3/4-16FORT X 3/8 BODY	1	
JPUFF50110FO	7/8-14FORT X 1/2 BODY	1	
JPUFF75112FO	1 1/16FORT X 3/4 BODY	1	

## NON SPILL HYDRAULIC NIPPLE

FF SERIES - PARKER

Line: 880-11

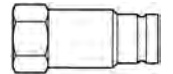

PART NUMBER	SIZE	QTY/BX	LIST PRICE
JSUFF2524FP	1/4-18 FPT X 1/4 BODY	1	
JSUFF3726FP	3/8-18 FPT X 3/8 BODY	1	
JSUFF3728FP	1/2-14 FPT X 3/8 BODY	1	
JSUFF5028FP	1/2-14 FPT X 1/2 BODY	1	
JSUFF2526FO	9/16-18FORT X 1/4BODY	1	
JSUFF75212FP	3/4-14FPT X 3/4 BODY	1	
JSUFF3728FO	3/4-16FORT X 3/8 BODY	1	
JSUFF50210FO	7/8-14 FORT X 1/2BODY	1	
JSUFF75212FO	1 1/16 FORT X 3/4BODY	1	

## NON SPILL HYDRAULIC COUPLER

NS SERIES - PARKER

Line: 880-12

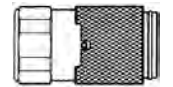

PART NUMBER	SIZE	QTY/BX	LIST PRICE
JVUNS3716FP	3/8-18 FPT X 3/8 BODY	1	
JVUNS5018FP	1/2-14 FPT X 1/2 BODY	1	
JVUNS75112FP	3/4-14 FPT X 3/4 BODY	1	
JVUNS100116FP	1-11 1/2FPT X 1BODY	1	

## NON SPILL HYDRAULIC NIPPLE

NS SERIES - PARKER

Line: 880-13

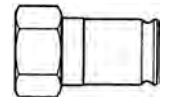

PART NUMBER	SIZE	QTY/BX	LIST PRICE
JZUNS3726FP	3/8-18 FPT X 3/8 BODY	1	
JZUNS5028FP	1/2-14 FPT X 1/2 BODY	1	
JZUNS75212FP	3/4-14 FPT X 3/4 BODY	1	
JZUNS100216FP	1-11 1/2FPT X 1BODY	1	

## FULL FLOW COUPLERS & NIPPLES

ST SERIES  
Line: 880-14



PART NUMBER	SIZE	QTY/BX	LIST PRICE
BJHBSTN1M	1/8-27 MLE NIP BRASS	5	
BJHBST1M	1/8-27 MLE CPLR BRASS	5	
BJHSSTN1M	1/8-27 MLE NIP S/S	1	
BJHSST1M	1/8-27 MLE CPLR S/S	1	
BJHBSTN1	1/8NPT FEM NIP BRASS	1	
BJHBST1	1/8NPT FEM CPLR BRASS	1	
BJHSSTN1	1/8NPT FEM NIP S/S	1	
BJHSST1	1/8NPT FEM CPLR S/S	1	
BJHBSTN2	1/4NPT FEM NIP BRASS	1	
BJHBST2	1/4NPT FEM CPLR BRASS	1	
BJHSSTN2	1/4NPT FEM NIP S/S	1	
BJHSST2	1/4NPT FEM CPLR S/S	1	
BJHBSTN2M	1/4-18 MLE NIP BRASS	1	
BJHBST2M	1/4-18 MLE CPLR BRASS	1	
BJHSSTN2M	1/4-18 MLE NIP S/S	1	
BJHSST2M	1/4-18 MLE CPLR S/S	1	
BJHBSTN3	3/8NPT FEM NIP BRASS	1	
BJHBST3	3/8NPT FEM CPLR BRASS	1	
BJHSSTN3	3/8NPT FEM NIP S/S	1	
BJHSST3	3/8NPT FEM CPLR S/S	1	
BJHBSTN3M	3/8-18 MLE NIP STL	1	
BJHBST3M	3/8-18 MLE CPLR BRASS	1	
BJHSSTN3M	3/8-18 MLE NIP S/S	1	
BJHSST3M	3/8-18 MLE CPLR S/S	1	
BJHBSTN4M	1/2-14 MLE NIP BRASS	1	
BJHBST4M	1/2-14 MLE CPLR BRASS	1	
BJHSSTN4M	1/2-14 MLE NIP S/S	1	
BJHSST4M	1/2-14 MLE CPLR S/S	1	
BJHBSTN4	1/2NPT FEM NIP BRASS	1	
BJHBST4	1/2NPT FEM CPLR BRASS	1	
BJHSSTN4	1/2NPT FEM NIP S/S	1	
BJHSST4	1/2NPT FEM CPLR S/S	1	
BJHBSTN6M	3/4-14 MLE NIP BRASS	1	
BJHBST6M	3/4-14 MLE CPLR BRASS	1	
BJHSSTN6M	3/4-14 MLE NIP S/S	1	
BJHSST6M	3/4-14 MLE CPLR S/S	1	
BJHBSTN6	3/4NPT FEM NIP BRASS	1	
BJHBST6	3/4NPT FEM CPLR BRASS	1	
BJHSSTN6	3/4NPT FEM NIP S/S	1	
BJHSST6	3/4NPT FEM CPLR S/S	1	
BJHSTN6	3/4NPT FEM NIP STEEL	1	
BJHBSTN8M	1-11 1/2 MLE NIP BR	1	
BJHBST8M	1-11 1/2 MLE CPLR B	1	
BJHSSTN8M	1-11 1/2 MLE NIP SS	1	

(continued...)

## FULL FLOW COUPLERS & NIPPLES (cont.)

ST SERIES  
Line: 880-14



PART NUMBER	SIZE	QTY/BX	LIST PRICE
BJHSST8M	1-11 1/2 MLE CPLR S	1	
BJHBSTN8	1NPT FEM NIP BRASS	1	
BJHBST8	1NPT FEM CPLR BRASS	1	
BJHSSTN8	1NPT FEM NIP S/S	1	
BJHSST8	1NPT FEM CPLR S/S	1	
BJHBSTN10	1 1/4NPT FEM NIP BRASS	1	
BJHBST10	1 1/4NPT FEM CPLR BR	1	
BJHBSTN12	1 1/2NPT FEM NIP BRASS	1	
BJHBST12	1 1/2NPT FEM CPL BRASS	1	

## WATER SERVICE COUPLER & NIPPLE

GARDEN HOSE THREAD

Line: 880-15



PART NUMBER	SIZE	QTY/BX	LIST PRICE
BJJ116360	FEM 3/4 GH CPLR	5	
BJJ116361	MLE 3/4 GH NIPPLE	5	

## PH55 SERIES CRIMP FITTING

MALE PIPE THREAD - PARFLEX STYLE

Line: 880-20

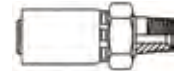

PART NUMBER	SIZE	QTY/BX	LIST PRICE
AGY10155X2X2	-2 X 1/8 IPT	5	
AGY10155X2X3	-3 X 1/8 IPT	5	
AGY10155X4X3	-3 X 1/4 IPT	5	
AGY10155X6X3	-3 X 3/8 IPT	5	
AGY10155X2X4	-4 X 1/8 IPT	5	
AGY10155X4X4	-4 X 1/4 IPT	5	
AGY10155X6X4	-4 X 3/8 IPT	5	
AGY10155X4X5	-5 X 1/4 IPT	5	
AGY10155X6X5	-5 X 3/8 IPT	5	
AGY10155X4X6	-6 X 1/4 IPT	5	
AGY10155X6X6	-6 X 3/8 IPT	5	
AGY10155X8X6	-6 X 1/2 IPT	5	
AGY10155X6X8	-8 X 3/8 IPT	5	
AGY10155X8X8	-8 X 1/2 IPT	5	
AGY10155X1212	-12 X 3/4 IPT	2	
AGY10155X1616	-16 X 1 IPT	2	

## PH58 SERIES CRIMP FITTING

MALE PIPE THREAD - PARFLEX STYLE

Line: 880-21

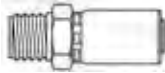

PART NUMBER	SIZE	QTY/BX	LIST PRICE
AGZ10158X8X8	-8 X 1/2 IPT	5	
AGZ10158X1212	-12 X 3/4 IPT	2	
AGZ10158X1616	-16 X 1 IPT	2	

## PH55 SERIES CRIMP FITTING

FEMALE PIPE THREAD - PARFLEX STYLE

Line: 880-22

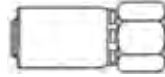

PART NUMBER	SIZE	QTY/BX	LIST PRICE
AHB10255X4X4	-4 X 1/4 IPT	5	
AHB10255X6X4	-4 X 3/8 IPT	5	
AHB10255X6X6	-6 X 3/8 IPT	5	
AHB10255X8X6	-6 X 1/2 IPT	5	
AHB10255X8X8	-8 X 1/2 IPT	5	

## PH55 SERIES CRIMP FITTING

MALE 37° JIC - PARFLEX STYLE

Line: 880-23

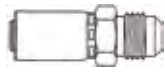

PART NUMBER	SIZE	QTY/BX	LIST PRICE
AHD10355X4X3	-3 X 1/4 JIC	5	
AHD10355X4X4	-4 X 1/4 JIC	5	
AHD10355X5X4	-4 X 5/16 JIC	5	
AHD10355X6X4	-4 X 3/8 JIC	5	
AHD10355X5X5	-5 X 5/16 JIC	5	
AHD10355X6X5	-5 X 3/8 JIC	5	
AHD10355X6X6	-6 X 3/8 JIC	5	
AHD10355X8X6	-6 X 1/2 JIC	5	
AHD10355X10X8	-8 X 5/8 JIC	2	
AHD10355X8X8	-8 X 1/2 JIC	5	
AHD10355X1212	-12 X 3/4 JIC	2	
AHD10355X1616	-16 X 1 JIC	1	

## PH58 SERIES CRIMP FITTING

MALE 37° JIC - PARFLEX STYLE

Line: 880-24

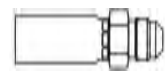

PART NUMBER	SIZE	QTY/BX	LIST PRICE
AHE10358X1010	-10 X 5/8 JIC	2	
AHE10358X1212	-12 X 3/4 JIC	2	
AHE10358X1616	-16 X 1 JIC	2	

## PH55 SERIES CRIMP FITTING

MALE 45° FITTING - PARFLEX STYLE

Line: 880-25

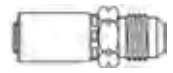

PART NUMBER	SIZE	QTY/BX	LIST PRICE
AHF10455X4X3	-3 X 1/4	5	
AHF10455X5X4	-4 X 5/16 SAE	5	
AHF10455X6X5	-5 X 3/8 SAE	5	
AHF10455X6X6	-6 X 3/8 SAE	5	
AHF10455X6X8	-8 X 3/8 SAE	5	
AHF10455X8X8	-8 X 1/2 SAE	5	
AHF10455X1212	-12 X 3/4 SAE	2	

## PH58 SERIES CRIMP FITTING

MALE 45° FITTING - PARFLEX STYLE

Line: 880-26

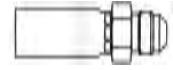

PART NUMBER	SIZE	QTY/BX	LIST PRICE
AHG10458X1212	-12 X 3/4 SAE	2	

## PH55 SERIES CRIMP FITTING

STRAIGHT THREAD O-RING - PARFLEX STYLE

Line: 880-27

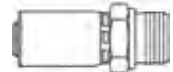

PART NUMBER	SIZE	QTY/BX	LIST PRICE
AHH10555X4X3	-3 X 1/4 BST	2	
AHH10555X4X4	-4 X 1/4 BST	5	
AHH10555X5X4	-4 X 5/16 BST	2	
AHH10555X6X4	-4 X 3/8 BST	2	
AHH10555X4X5	-5 X 1/4 BST	2	
AHH10555X5X5	-5 X 5/16 BST	2	
AHH10555X6X6	-6 X 3/8 BST	2	
AHH10555X8X6	-6 X 1/2 BST	2	
AHH10555X10X8	-8 X 5/8 BST	2	
AHH10555X8X8	-8 X 1/2 BST	2	

### PH55 SERIES CRIMP FITTING

37° FEMALE SWIVEL JIC - PARFLEX STYLE

Line: 880-28

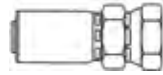

PART NUMBER	SIZE	QTY/BX	LIST PRICE
AHJ10655X3X2	-2 X 3/16 JIC	5	
AHJ10655X4X2	-2 X 1/4 JIC	5	
AHJ10655X4X3	-3 X 1/4 JIC	5	
AHJ10655X5X3	-3 X 5/16 JIC	5	
AHJ10655X4X4	-4 X 1/4 JIC	5	
AHJ10655X5X4	-4 X 5/16 JIC	5	
AHJ10655X6X4	-4 X 3/8 JIC	5	
AHJ10655X5X5	-5 X 5/16 JIC	5	
AHJ10655X6X5	-5 X 3/8 JIC	5	
AHJ10655X6X6	-6 X 3/8 JIC	5	
AHJ10655X8X6	-6 X 1/2 JIC	5	
AHJ10655X10X8	-8 X 5/8 JIC	2	
AHJ10655X8X8	-8 X 1/2 JIC	2	
AHJ10655X1010	-10 X 5/8 JIC	2	
AHJ10655X1012	-12 X 5/8	2	
AHJ10655X1212	#12 X 3/4 JIC	2	
AHJ10655X1616	-16 X 1 JIC	1	

### PH58 SERIES CRIMP FITTING

37° FEMALE SWIVEL JIC - PARFLEX STYLE

Line: 880-29

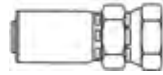

PART NUMBER	SIZE	QTY/BX	LIST PRICE
AHK10658X1010	-10 X 5/8 FE JIC	2	
AHK10658X1212	-12 X 3/4 JIC	2	
AHK10658X1616	-16 X 1 JIC	2	

### PH55 SERIES CRIMP FITTING

FEMALE PIPE SWIVEL - PARFLEX STYLE

Line: 880-30

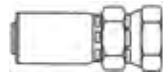

PART NUMBER	SIZE	QTY/BX	LIST PRICE
AHL10755X4X4	-4 X 1/4 IPT	5	
AHL10755X4X5	-5 X 1/4 IPT	5	
AHL10755X6X6	-6 X 3/8 IPT	5	
AHL10755X8X8	-8 X 1/2 IPT	5	

### PH55 SERIES CRIMP FITTING

45° FEMALE SAE SWIVEL - PARFLEX STYLE

Line: 880-31

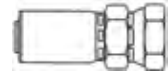

PART NUMBER	SIZE	QTY/BX	LIST PRICE
AHM10855X4X2	-2 X 1/4 SAE	5	
AHM10855X4X3	-3 X 1/4 SAE	5	
AHM10855X5X3	-3 X 5/16 SAE	5	
AHM10855X4X4	-4 X 1/4 SAE	5	
AHM10855X5X4	-4 X 5/16 SAE	5	
AHM10855X6X4	-4 X 3/8 SAE	5	
AHM10855X5X5	-5 X 5/16 SAE	5	
AHM10855X6X5	-5 X 3/8 SAE	5	
AHM10855X6X6	-6 X 3/8 SAE	5	
AHM10855X8X6	-6 X 1/2 SAE	5	
AHM10855X10X8	-8 X 5/8 SAE	2	
AHM10855X8X8	-8 X 1/2 SAE	5	
AHM10855X1212	-12 X 3/4 SAE	2	

### PH58 SERIES CRIMP FITTING

45° FEMALE SAE SWIVEL - PARFLEX STYLE

Line: 880-32

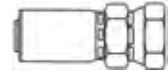

PART NUMBER	SIZE	QTY/BX	LIST PRICE
AHN10858X1212	-12 X 3/4 SAE	2	

### PH55 SERIES CRIMP FITTING

MALE PIPE SWIVEL - PARFLEX STYLE

Line: 880-33

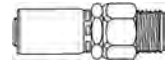

PART NUMBER	SIZE	QTY/BX	LIST PRICE
AHP11355X4X3	-3 X 1/4 MPT	5	
AHP11355X4X4	-4 X 1/4 MPT	5	
AHP11355X4X5	-5 X 1/4 MPT	5	
AHP11355X6X6	-6 X 3/8 MPT	5	
AHP11355X8X6	-6 X 1/2 MPT	5	
AHP11355X8X8	-8 X 1/2 MPT	5	
AHP11355X1212	-12 X 3/4 MPT	2	
AHP11355X1616	-16 X 1 MPT	2	

### PH58 SERIES CRIMP FITTING

MALE PIPE SWIVEL - PARFLEX STYLE

Line: 880-34

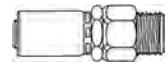

PART NUMBER	SIZE	QTY/BX	LIST PRICE
AHR11358X1212	-12 X 3/4 MPT	2	
AHR11358X1616	-16 X 1 MPT	2	

### PH55 SERIES CRIMP FITTING

90° MALE PIPE SWIVEL JIC FITTING - PARFLEX STYLE

Line: 880-35

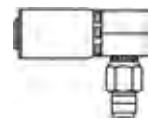

PART NUMBER	SIZE	QTY/BX	LIST PRICE
AHT11L55X4X4	-4 X 1/4 MPT	5	

## PH55 SERIES CRIMP FITTING

45° ELBOW JIC FITTING - PARFLEX STYLE

Line: 880-36

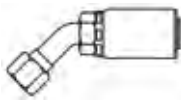

PART NUMBER	SIZE	QTY/BX	LIST PRICE
AHV13755X4X3	-3 X 1/4 JIC	5	
AHV13755X4X4	-4 X 1/4 JIC	5	
AHV13755X5X4	-4 X 5/16 JIC	5	
AHV13755X6X5	-5 X 3/8 JIC	5	
AHV13755X6X6	-6 X 3/8 JIC	5	
AHV13755X8X6	-6 X 1/2 JIC	5	
AHV13755X10X8	-8 X 5/8 JIC	2	
AHV13755X8X8	-8 X 1/2 JIC	2	
AHV13755X1212	-12 X 3/4 JIC	2	
AHV13755X1616	-16 X 1 JIC	2	

## PH58 SERIES CRIMP FITTING

45° ELBOW, 37° JIC FITTING - PARFLEX STYLE

Line: 880-37

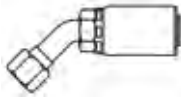

PART NUMBER	SIZE	QTY/BX	LIST PRICE
AHW13758X1212	-12 X 3/4 JIC	2	
AHW13758X1616	-16 X 1 JIC	2	

## PH55 SERIES CRIMP FITTING

90° ELBOW, 37° JIC FITTING - PARFLEX STYLE

Line: 880-38

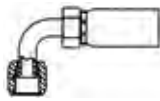

PART NUMBER	SIZE	QTY/BX	LIST PRICE
AHX1L955X4X3	-3 X 1/4 JIC	5	
AHX1L955X4X4	-4 X 1/4 JIC	5	
AHX1L955X5X4	-4 X 5/16 JIC	5	
AHX13955X6X4	-4 X 3/8 JIC	5	
AHX1L955X6X5	-5 X 3/8 JIC	5	
AHX1L955X6X6	-6 X 3/8 JIC	5	
AHX1L955X8X6	-6 X 1/2 JIC	5	
AHX1L955X10X8	-8 X 5/8 JIC	2	
AHX1L955X8X8	-8 X 1/2 JIC	5	
AHX13955X1010	-10 X 5/8 JIC	2	
AHX1L955X1212	-12 X 3/4 JIC	2	
AHX1L955X1616	-16 X 1 JIC	2	

## PH58 SERIES CRIMP FITTING

90° ELBOW, 37° JIC FITTING - PARFLEX STYLE

Line: 880-39

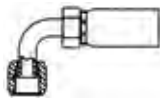

PART NUMBER	SIZE	QTY/BX	LIST PRICE
AHY13958X1010	-10 X 5/8	5	
AHY1L958X1212	-12 X 3/4 JIC	2	
AHY13958X1212	-12 X 3/4	5	
AHY1L958X1616	-16 X 1 JIC	2	

## PH55 SERIES CRIMP FITTING

90° LONG ELBOW, 37° JIC FITTING - PARFLEX STYLE

Line: 880-40

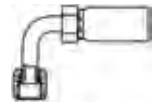

PART NUMBER	SIZE	QTY/BX	LIST PRICE
AHZ14155X4X3	-3 X 1/4 JIC	1	
AHZ14155X5X4	-4 X 5/16 JIC	1	
AHZ14155X6X5	-5 X 3/8 JIC	1	
AHZ14155X6X6	-6 X 3/8 JIC	1	
AHZ14155X8X6	-6 X 1/2 JIC	1	
AHZ14155X10X8	-8 X 5/8 JIC	1	
AHZ14155X8X8	-8 X 1/2 JIC	1	
AHZ14155X1212	-12 X 3/4 JIC	1	
AHZ14155X1616	-16 X 1 JIC	1	

## PH58 SERIES CRIMP FITTING

90° LONG ELBOW, 37° JIC FITTING - PARFLEX STYLE

Line: 880-41

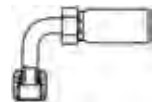

PART NUMBER	SIZE	QTY/BX	LIST PRICE
AJB14158X1212	-12 X 3/4	1	
AJB14158X1616	-16 X 1	1	

## PH91 #10191 MALE PIPE THREAD CRIMP FITTING

BRASS NIPPLE/STEEL SHELL

Line: 880-42

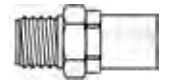

PART NUMBER	SIZE	QTY/BX	LIST PRICE
AJD10190X24B	-4 X 1/8 PIPE	5	
AJD10190X44B	-4 X 1/4 PIPE	5	
AJD10190X45B	-5 X 1/4 PIPE	5	
AJD10190X46B	-6 X 1/4 PIPE	5	
AJD10190X66B	-6 X 3/8 PIPE	5	
AJD10190X68B	-8 X 3/8 PIPE	5	
AJD10190X88B	-8 X 1/2 PIPE	5	
AJD10190X810B	-10 X 1/2 PIPE	2	
AJD10190X12B	-12 X 3/4 PIPE	2	
AJD10190X16B	-16 X 1 PIPE	2	
AJD10190X20B	-20 X 1 1/4 PIPE	2	

### PH91 PARFLEX MALE PIPE THREAD

STAINLESS STEEL-NIPPLE AND SHELL

Line: 880-43

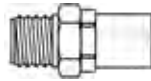

PART NUMBER	SIZE	QTY/BX	LIST PRICE
AJE10191X24C	-4 X 1/8 PIPE	5	
AJE10191X44C	-4 X 1/4 PIPE	5	
AJE10191X45C	-5 X 1/4 PIPE	5	
AJE10191X55C	-5 X 5/16	1	
AJE10191X46C	-6 X 1/4 PIPE	5	
AJE10191X66C	-6 X 3/8	5	
AJE10191X68C	-8 X 3/8 PIPE	5	
AJE10191X88C	-8 X 1/2 PIPE	5	
AJE10191X810C	-10 X 1/2 PIPE	2	
AJE10191X12C	-12 X 3/4 PIPE	2	
AJE10191X16C	-16 X 1 PIPE	2	

### PH91 FEM JIC SWV #10691

BRASS NIPPLE/STEEL SHELL

Line: 880-45

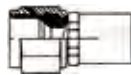

PART NUMBER	SIZE	QTY/BX	LIST PRICE
AJG10690X44B	-4 X 1/4 JIC	5	
AJG10690X55B	-5 X 5/16 JIC	5	
AJG10690X66B	-6 X 3/8 JIC	5	
AJG10690X88B	-8 X 1/2 JIC	5	
AJG10690X10B	-10 X 5/8 JIC 10691N	5	
AJG10690X12B	-12 X 3/4 JIC	2	
AJG10690X16B	-16 X 1 JIC	2	
AJG10690X20B	-20 X 1 1/4 JIC	2	

### PH91 FEM JIC SWIVEL ST/STL PARFLEX

ALL STAINLESS

Line: 880-46

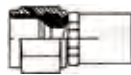

PART NUMBER	SIZE	QTY/BX	LIST PRICE
AJH10691X44C	-4 X 1/4 JIC	2	
AJH10691X55C	-5 X 5/16 JIC	2	
AJH10691X66C	-6 X 3/8 JIC	2	
AJH10691X88C	-8 X 1/2 JIC	2	
AJH10691X10C	-10 X 5/8 JIC	2	
AJH10691X12C	-12 X 3/4 JIC	2	

### PH91 FE 45° SAE SWIVEL #10891

BRASS NIPPLE/STEEL SHELL

Line: 880-47



PART NUMBER	SIZE	QTY/BX	LIST PRICE
AJJ10890X44B	-4 X 1/4 SAE	5	
AJJ10890X55B	-5 X 5/16 SAE	5	
AJJ10890X66B	-6 X 3/8 SAE	5	
AJJ10890X88B	-8 X 1/2 SAE	5	
AJJ10890X10B	-10 X 5/8 SAE	5	
AJJ10890X12B	-12 X 3/4 SAE	2	

### PH91 #13491 AIR BRK STR TUBE FITT

BRASS NIPPLE/STEEL SHELL

Line: 880-48

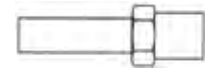

PART NUMBER	SIZE	QTY/BX	LIST PRICE
AJK13490X10B	-10 X 5/8 TUBE	2	
AJK13490X810B	-10 X 1/2 TUBE	2	
AJK13490X12B	-12 X 3/4 TUBE	2	

### PH91 AIR BRK STR COMP END FITT

#1619N BRASS NIPPLE/STEEL SHELL

Line: 880-49

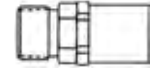

PART NUMBER	SIZE	QTY/BX	LIST PRICE
AJL16190X10B	-10 X 5/8 AB	2	
AJL16190X810B	-10 X 1/2 AB	2	
AJL16190X12B	-12 X 3/4 AB	2	

### 1JC55 SEAL-LOK STRAIGHT SHORT PARFLEX

SS SERIES CRIMP FITTING

Line: 880-54

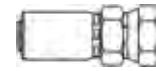

PART NUMBER	SIZE	QTY/BX	LIST PRICE
BGN1JC5544	-4 H X 1/4 S/L	5	
BGN1JC5564	-4 H X 3/8 S/L	5	
BGN1JC5566	-6 H X 3/8 S/L	5	
BGN1JC5586	-6 H X 1/2 S/L	5	
BGN1JC5588	-8 H X 1/2 S/L	2	
BGN1JC551012	-12 H X 5/8 S/L	2	
BGN1JC551212	-12 H X 3/4 S/L	2	
BGN1JC551616	-16 H X 1 S/L	2	

### PH55 SEAL LOK STRAIGHT PARFLEX

SS SERIES - CRIMP FITTING

Line: 880-55

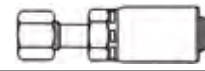

PART NUMBER	SIZE	QTY/BX	LIST PRICE
ATP1JS55X4X4	1/4H X 1/4T	5	
ATP1JS55X6X4	1/4H X 3/8T	5	
ATP1JS55X6X5	-5 H X 3/8 T	4	
ATP1JS55X6X6	3/8H X 3/8T	5	
ATP1JS55X8X6	3/8H X 1/2T	5	
ATP1JS55X8X8	1/2H X 1/2T	2	

### PH55 SEAL LOK 90° ELBOW PARFLEX LONG FITT

SS SERIES - CRIMP FITTING

Line: 880-56

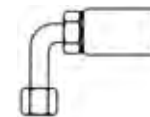

PART NUMBER	SIZE	QTY/BX	LIST PRICE
ATR1J155X4X4	1/4H X 1/4T	5	
ATR1J155X6X5	-5 H X 3/8 T	4	
ATR1J155X6X6	3/8H X 3/8T	5	
ATR1J155X8X8	1/2H X 1/2T	2	



## PH55 SEAL LOK 45° ELBOW PARFLEX

SS SERIES CRIMP FITTING

Line: 880-57

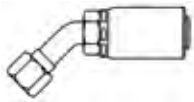

PART NUMBER	SIZE	QTY/BX	LIST PRICE
ATS1J755X4X4	1/4 H X 1/4 T	5	
ATS1J755X6X6	3/8 H X 3/8 T	5	
ATS1J755X8X8	1/2 H X 1/2 T	2	

## PH55 PARFLEX SEAL LOK 90° SHORT SV ELE

SS SERIES CRIMP FITTING

Line: 880-58

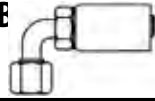

PART NUMBER	SIZE	QTY/BX	LIST PRICE
BEN1J955X44	1/4 H X 1/4 T	5	
BEN1J955X66	3/8 H X 3/8 T	5	
BEN1J955X88	1/2 H X 1/2 T	5	
BEN1J955X1212	3/4 H X 3/4 T	2	
BEN1J955X1616	1 H X 1 T	2	

## 92 SERIES ST/STL MARINE PTH

HOSE FITTINGS

Line: 880-75

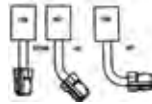

PART NUMBER	SIZE	QTY/BX	LIST PRICE
ASE1119233C	-3 X 3/16 FURFX S/S	1	
ASE1289233C	-3 X 3/16 INV STR SS	1	
ASE1679233C	-3 X 3/16 INV 45 S/S	1	
ASE1699233C	-3 X 3/16 INV 90 S/S	1	

## UNIVERSAL SURE SEAL DUAL WIRE BOLT

HOSE CLAMP

Line: 880-99



PART NUMBER	SIZE	QTY/BX	LIST PRICE
SSC1920	1 3/4(1.72/1.92)	1	
SSC2030	2(1.83 / 2.03)	1	
SSC2280	2 1/4(2.08 / 2.28)	1	
SSC2530	2 1/2(2.33 / 2.53)	1	
SSC2780	2 3/4 (2.58 / 2.78)	1	
SSC3030	3(2.83 / 3.03)	1	
SSC3530	3 1/2(3.33 / 3.53)	1	
SSC4030	4(3.83 / 4.03)	1	
SSC4530	4 1/2(4.33 / 4.53)	1	
SSC5030	5(4.83 / 5.03)	1	
SSC5530	5 1/2(5.33 / 5.53)	1	
SSC6030	6(5.83 / 6.03)	1	
SSC6530	6 1/2(6.33 / 6.53)	1	
SSC7030	7(6.83 / 7.03)	1	
SSC8030	8(7.83 / 8.03)	1	

## J-LOCK ST/STL BAND CLAMP



Line: 881-00

PART NUMBER	SIZE	QTY/BX	LIST PRICE
AZWPJ201	13/16 X 3/8	100	
AZWPJ293	1 X 5/8 W	100	
AZWPJ294	1 1/4 X 5/8 W	100	
AZWPJ205	1 1/2 X 5/8 W	100	
AZWPJ206	1 3/4 X 5/8 W	100	
AZWPJ207	2 X 5/8 W	100	
AZWPJ208	2 1/4 X 5/8 W	100	
AZWPJ209	2 1/2 X 5/8 W	100	
AZWPJ210	2 3/4 X 3/4 W	50	
AZWPJ211	3 X 3/4 W	50	
AZWPJ212	3 1/2 X 3/4 W	50	
AZWPJ213	4 X 3/4 W	25	
AZWPJ214	4 1/2 X 3/4 W	25	
AZWPJ215	5 X 3/4 W	25	
AZWPJ216	6 X 3/4 W	25	

## BANDIT F/S STEEL CLAMP

PUNCH-LOK STYLE

Line: 881-01



PART NUMBER	SIZE	QTY/BX	LIST PRICE
JHHPB304	1/2 W X .030 T X 100' ROLL	1	
JHHS3	13/16 ID X 3/8 W	100	
JHHS4	1 ID X 5/8 W	100	
JHHS5	1 1/4 ID X 5/8 W	100	
JHHS311	1 3/8 ID X 3/8 W	100	
JHHS6	1 1/2 ID X 5/8 W	100	
JHHS7	1 3/4 ID X 5/8 W	100	
JHHS8	2 ID X 5/8 W	100	
JHHS9	2 1/4 ID X 5/8 W	100	
JHHS10	2 1/2 ID X 5/8 W	50	
JHHS11	2 3/4 ID X 5/8 W	50	
JHHS12	3 ID X 5/8 W	50	
JHHS14	3 1/2 ID X 5/8 W	50	
JHHS16	4 ID X 5/8 W	25	
JHHS18	4 1/2 ID X 5/8 W	25	
JHHS20	5 ID X 5/8 W	25	
JHHS24	6 ID X 5/8 W	25	

**BANDIT F/S STAINLESS STEEL CLAMP**

PUNCH-LOK STYLE

Line: 881-02



PART NUMBER	SIZE	QTY/BX	LIST PRICE
JIHS3S	7/8 ID X 3/8 W	100	
JIHS4S	1 ID X 5/8 W	100	
JIHS5S	1 1/4 ID X 5/8 W	100	
JIHS311S	1 3/8 ID X 3/8 W	100	
JIHS6S	1 1/2 ID X 5/8 W	100	
JIHS7S	1 3/4 ID X 5/8 W	100	
JIHS8S	2 ID X 5/8 W	100	
JIHS9S	2 1/4 ID X 5/8 W	100	
JIHS10S	2 1/2 ID X 5/8 W	50	
JIHS11S	2 3/4 ID X 5/8 W	50	
JIHS12S	3 ID X 5/8 W	50	
JIHS14S	3 1/2 ID X 5/8 W	50	
JIHS16S	4 ID X 5/8 W	25	
JIHS18S	4 1/2 ID X 5/8 W	25	
JIHS20S	5 ID X 5/8 W	25	
JIHS24S	6 ID X 5/8 W	25	

**COLL-O-CRIMP MALE PIPE U-SERIES FITTING**

Line: 881-03



PART NUMBER	SIZE	QTY/BX	LIST PRICE
JTK04U102	1/4H X 1/8MP	5	
JTK04U104	1/4H X 1/4MP	5	
JTK04U106	1/4H X 3/8MP	5	
JTK04U108	1/4H X 1/2MP	5	
JTK06U104	3/8H X 1/4MP	5	
JTK06U106	3/8H X 3/8MP	5	
JTK06U108	3/8H X 1/2MP	5	
JTK08U106	1/2H X 3/8MP	5	
JTK08U108	1/2H X 1/2MP	5	
JTK08U112	1/2H X 3/4MP	5	
JTK10U106	5/8H X 3/8MP	5	
JTK10U108	5/8H X 1/2MP	5	
JTK10U112	5/8H X 3/4MP	5	
JTK12U108	3/4H X 1/2MP	5	
JTK12U112	3/4H X 3/4MP	5	
JTK12U116	3/4H X 1MP	5	
JTK16U112	1H X 3/4MP	5	
JTK16U116	1H X 1MP	5	
JTK20U120	1 1/4H X 1 1/4MP	5	

**COLL-O-CRIMP JIC FEM SWIVEL U-SERIES FITTING**

Line: 881-04

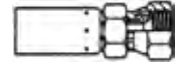

PART NUMBER	SIZE	QTY/BX	LIST PRICE
JUK04U604	1/4H X 1/4T	5	
JUK04U605	1/4H X 5/16T	5	
JUK04U606	1/4H X 3/8T	5	
JUK06U406	3/8H X 3/8T-SAE	5	
JUK06U604	3/8H X 1/4T	5	
JUK06U606	3/8H X 3/8T	5	
JUK06U608	3/8H X 1/2T	5	
JUK06U610	3/8H X 5/8T	5	
JUK06U612	3/8H X 3/4T	5	
JUK08U606	1/2H X 3/8T	5	
JUK08U608	1/2H X 1/2T	5	
JUK08U610	1/2H X 5/8T	5	
JUK08U612	1/2H X 3/4T	5	
JUK08U616	1/2H X 1T	5	
JUK10U608	5/8H X 1/2T	5	
JUK10U610	5/8H X 5/8T	5	
JUK10U612	5/8H X 3/4T	5	
JUK12U412	3/4H X 3/4T-SAE	5	
JUK12U610	3/4H X 5/8T	5	
JUK12U612	3/4H X 3/4T	5	
JUK12U614	3/4H X 7/8T	5	
JUK12U616	3/4H X 1T	5	
JUK16U614	1H X 7/8T	5	
JUK16U616	1H X 1T	5	
JUK20U620	1 1/4H X 1 1/4T	5	



**CALL - 1 (800) 723-2826**

## COLL-O-CRIMP JIC FEM 90° SWIVEL FITTING

U-SERIES

Line: 881-05

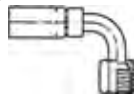

PART NUMBER	SIZE	QTY/BX	LIST PRICE
JVK04U664	1/4H X 1/4 T	5	
JVK04U665	1/4H X 5/16 T	5	
JVK04U666	1/4H X 3/8 T	5	
JVK06U446	3/8H X 3/8T-SAE	5	
JVK06U644L	3/8H X 1/4 T	5	
JVK06U646L	3/8 HOSE X 3/8 T	5	
JVK06U664	3/8H X 1/4 T	5	
JVK06U666	3/8H X 3/8 T	5	
JVK06U668	3/8H X 1/2 T	5	
JVK08U648L	1/2 H X 1/2 T LNG	5	
JVK08U668	1/2H X 1/2 T	5	
JVK08U670	1/2H X 5/8 T	5	
JVK10U670	5/8H X 5/8 T	5	
JVK12U652L	3/4H X 3/4 T LNG	2	
JVK12U670	3/4H X 5/8 T	5	
JVK12U672	3/4H X 3/4 T	5	
JVK16U676	1H X 1 T	5	

## COLL-O-CRIMP JIC MALE RIGID FITTING

U-SERIES

Line: 881-06

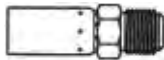

PART NUMBER	SIZE	QTY/BX	LIST PRICE
JWK04U504	1/4H X 1/4 T	5	
JWK04U505	1/4H X 5/16 T	5	
JWK04U506	1/4H X 3/8 T	5	
JWK06U306	3/8H X 3/8 SAE	5	
JWK06U506	3/8H X 3/8 T	5	
JWK06U508	3/8H X 1/2 T	5	
JWK06U510	3/8H X 5/8 T	5	
JWK08U508	1/2H X 1/2 T	5	
JWK08U510	1/2H X 5/8 T	5	
JWK08U512	1/2H X 3/4 T	5	
JWK10U508	5/8H X 1/2 T	5	
JWK10U510	5/8H X 5/8 T	5	
JWK10U512	5/8H X 3/4 T	5	
JWK12U510	3/4H X 5/8 T	5	
JWK12U512	3/4H X 3/4 T	5	
JWK12U514	3/4H X 7/8 T	5	
JWK12U516	3/4H X 1 T	5	
JWK16U514	1H X 7/8 T	5	
JWK16U516	1H X 1 T	5	
JWK20U520	1 1/4H X 1 1/4 T	5	

## COLL-O-CRIMP 45° JIC SWV ELBOW

U-SERIES FITTING

Line: 881-07

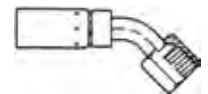

PART NUMBER	SIZE	QTY/BX	LIST PRICE
JXK04U684	1/4H X 1/4 T	5	
JXK04U685	1/4H X 5/16 T	5	
JXK06U684	-6 HOSE X 1/4 T	5	
JXK06U486	3/8H X 3/8T-SAE	5	
JXK06U686	3/8H X 3/8 T	5	
JXK06U688	3/8H X 1/2 T	5	
JXK08U688	1/2H X 1/2 T	5	
JXK08U690	1/2H X 5/8 T	5	
JXK12U692	3/4H X 3/4 T	5	
JXK16U696	1H X 1 T	2	

## COLL-O-CRIMP FLARELESS NUT/SLV ASSM FITTING

U-SERIES

Line: 881-08



PART NUMBER	SIZE	QTY/BX	LIST PRICE
JYK04U754	1/4H X 1/4 T	5	
JYK04U755	1/4H X 5/16 T	5	
JYK06U754	3/8H X 1/4 T	5	
JYK06U755	3/8H X 5/16 T	5	
JYK06U756	3/8H X 3/8 T	5	
JYK08U758	1/2H X 1/2 T	5	
JYK08U760	1/2H X 5/8 T	5	
JYK12U762	3/4H X 3/4 T	5	
JYK16U766	1H X 1 T	5	
JYK20U770	1 1/4H X 1 1/4 T	5	

## COLL-O-CRIMP MALE INV SWIV CONN FITTING

U-SERIES

Line: 881-09



PART NUMBER	SIZE	QTY/BX	LIST PRICE
JZK04UB04	1/4H X 1/4 T	5	
JZK04UB05	1/4H X 5/16 T	5	
JZK06UB04	3/8H X 1/4 T	5	
JZK06UB05	3/8H X 5/16 T	5	
JZK06UB06	3/8H X 3/8 T	5	
JZK06UB07	3/8H X 7/16 T	5	
JZK08UB08	1/2H X 1/2 T	5	
JZK08UB10	1/2H X 5/8 T	5	

**COLL-O-CRIMP MALE INV 45° EL SWIV**

U-SERIES

Line: 881-10

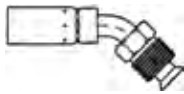

PART NUMBER	SIZE	QTY/BX	LIST PRICE
JAL04UB43	1/4H X 3/16T	5	
JAL04UB44	1/4H X 1/4T	5	
JAL04UB45	1/4H X 5/16T	5	
JAL06UB44	3/8H X 1/4T	5	
JAL06UB45	3/8H X 5/16T	5	
JAL06UB46	3/8H X 3/8T	5	
JAL06UB47	3/8H X 7/16 T	5	
JAL08UB48	1/2H X 1/2T	5	

**COLL-O-CRIMP MALE INV 90° ELBOW SWIVEL**

U-SERIES FITTING

Line: 881-11

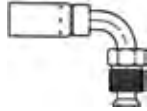

PART NUMBER	SIZE	QTY/BX	LIST PRICE
JBL04UB64	1/4H X 1/4T	5	
JBL04UB65	1/4H X 5/16T	5	
JBL06UB64	3/8H X 1/4T	5	
JBL06UB65	3/8H X 5/16T	5	
JBL06UB66	3/8H X 3/8T	5	
JBL06UB67	3/8H X 7/16 T	5	
JBL08UB68	1/2H X 1/2T	5	

**COLL-O-CRIMP MALE PIPE SWIVEL FITTING**

U-SERIES

Line: 881-12



PART NUMBER	SIZE	QTY/BX	LIST PRICE
JCL04UJ04	1/4H X 1/4MP	5	
JCL06UJ04	3/8H X 1/4MP	5	
JCL06UJ06	3/8H X 3/8MP	5	
JCL06UJ08	3/8H X 1/2MP	5	
JCL08UJ08	1/2H X 1/2MP	5	
JCL12UJ12	3/4H X 3/4MP	5	
JCL16UJ16	1H X 1MP	2	

**COL-CRIMP MALE STRA THD O-RING SWIVEL FITTING**

U-SERIES

Line: 881-15

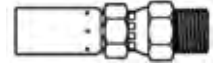

PART NUMBER	SIZE	QTY/BX	LIST PRICE
JFL06UR06	3/8H X 3/8STR/THD	5	
JFL06UR08	3/8H X 1/2STR/THD	5	
JFL08UR08	1/2H X 1/2STR/THD	5	
JFL08UR10	1/2H X 5/8STR/THD	5	
JFL08UR12	1/2H X 3/4STR/THD	5	
JFL10UR08	5/8H X 1/2STR/THD	5	
JFL10UR12	5/8H X 3/4STR/THD	5	
JFL12UR10	3/4H X 5/8STR/THD	5	

**COL-CRIMP MALE RIGID O-RING STR THD FITTING**

U-SERIES

Line: 881-16

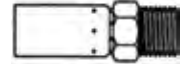

PART NUMBER	SIZE	QTY/BX	LIST PRICE
JGL04UP04	1/4H X 1/4STR/THD	5	
JGL04UP05	1/4H X 5/16STR/THD	5	
JGL04UP06	1/4H X 3/8STR/THD	5	
JGL06UP06	3/8H X 3/8STR/THD	5	
JGL06UP08	3/8H X 1/2STR/THD	5	
JGL06UP10	3/8H X 5/8STR/THD	5	
JGL08UP08	1/2H X 1/2STR/THD	5	
JGL08UP10	1/2H X 5/8STR/THD	5	
JGL08UP12	1/2H X 3/4STR/THD	5	
JGL10UP08	5/8H X 1/2STR/THD	5	
JGL10UP10	5/8H X 5/8STR/THD	5	
JGL10UP12	5/8H X 3/4STR/THD	5	
JGL12UP10	3/4H X 5/8STR/THD	5	
JGL12UP12	3/4H X 3/4STR/THD	5	
JGL12UP16	3/4H X 1 STR/THD	5	
JGL16UP16	1H X 1STR/THD	2	
JGL20UP20	1 1/4H X 1 1/4 ST/TD	5	

**COL-CRIMP 90° MST O-RING SWIVEL FITTING**

U-SERIES

Line: 881-17

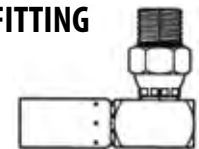

PART NUMBER	SIZE	QTY/BX	LIST PRICE
JHL04UR66	1/4H X 3/8STR/THD	5	
JHL06UR66	3/8H X 3/8STR/THD	5	
JHL06UR68	3/8H X 1/2STR/THD	5	
JHL06UR70	3/8H X 5/8STR/THD	5	
JHL08UR68	1/2H X 1/2STR/THD	5	
JHL08UR70	1/2H X 5/8STR/THD	5	
JHL08UR72	1/2H X 3/4STR/THD	5	
JHL12UR72	3/4H X 3/4STR/THD	5	

## COL-CRIMP 90° ELBOW MALE PIPE SWIVEL

U-SERIES FITTING

Line: 881-18

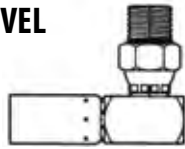

PART NUMBER	SIZE	QTY/BX	LIST PRICE
JWS04UM04	1/4H X 1/4MP	5	
JWS06UM06	3/8H X 3/8 MP	5	
JWS08UM08	1/2H X 1/2 MP	5	

## COL-CRIMP FEMALE PIPE THD RIGID

U-SERIES FITTING

Line: 881-19



PART NUMBER	SIZE	QTY/BX	LIST PRICE
JXS04U202	1/4H X 1/8 FP	5	
JXS04U204	1/4H X 1/4 FP	5	
JXS06U206	3/8H X 3/8 FP	5	
JXS08U208	1/2H X 1/2 FP	5	
JXS12U212	3/4H X 3/4 FP	5	

## COL-CRIMP FEMALE PIPE THD SWIVEL

U-SERIES FITTING

Line: 881-20



PART NUMBER	SIZE	QTY/BX	LIST PRICE
JYS04U254	1/4H X 1/4 FP	5	
JYS06U256	3/8H X 3/8 FP	5	
JYS08U258	1/2H X 1/2 FP	5	
JYS12U262	3/4H X 3/4 FP	5	

## COL-CRIMP FEM STRAIGHT THD SWIVEL

U-SERIES FITTING

Line: 881-21



PART NUMBER	SIZE	QTY/BX	LIST PRICE
JZS04U054	1/4H X 1/4 FP	5	
JZS06U056	3/8H X 3/8 FP	5	
JZS08U058	1/2H X 1/2 FP	5	
JZS12U062	3/4H X 3/4 FP	5	
JZS16U066	1 H X 1 FP	5	
JZS20U070	1 1/4H X 1 1/4 FP	5	

## COL-CRIMP JIC MALE ELBOW 90° RIGID

U-SERIES FITTING

Line: 881-22

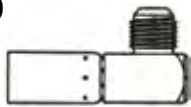

PART NUMBER	SIZE	QTY/BX	LIST PRICE
JAT06UX60	3/8H X 5/8 JIC	5	
JAT08UX60	1/2H X 5/8 JIC	5	
JAT12UX60	3/4H X 5/8 JIC	5	

## COL-CRIMP JIC FEMALE SWIVEL 90° ELBOW

U-SERIES FITTING

Line: 881-23

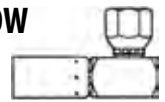

PART NUMBER	SIZE	QTY/BX	LIST PRICE
JBT04U554	1/4H X 1/4 JIC	5	
JBT06U556	3/8H X 3/8 JIC	5	
JBT08U558	1/2H X 1/2 JIC	5	
JBT08U560	1/2H X 5/8 JIC	5	
JBT12U560	3/4H X 5/8 JIC	5	
JBT12U564	3/4H X 7/8 JIC	5	

## COL-CRIMP SEAL LOCK STRA FEM SWIVEL

U-SERIES FITTING

Line: 881-35

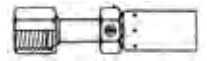

PART NUMBER	SIZE	QTY/BX	LIST PRICE
BSY04US64	-4 HOSE X 1/4 TUBE	5	
BSY04US66	-4 HOSE X 3/8 TUBE	5	
BSY04US68	-4 HOSE X 1/2 TUBE	5	
BSY06US66	-6 HOSE X 3/8 TUBE	5	
BSY06US68	-6 HOSE X 1/2 TUBE	5	
BSY08US66	-8 HOSE X 3/8 TUBE	5	
BSY08US68	-8 HOSE X 1/2 TUBE	5	
BSY08US70	-8 HOSE X 5/8 TUBE	5	
BSY08US72	-8 HOSE X 3/4 TUBE	2	
BSY10US70	-10 HOSE X 5/8 TUBE	2	
BSY10US72	-10 HOSE X 3/4 TUBE	2	
BSY12US70	-12 HOSE X 5/8 TUBE	5	
BSY12US72	-12 HOSE X 3/4 TUBE	2	
BSY12US76	-12 X 1 TUBE	2	
BSY16US76	-16 HOSE X 1 TUBE	2	

## COL-CRIMP SEAL LOCK 45° ELBOW FEM SWIVEL

U-SERIES FITTING

Line: 881-36

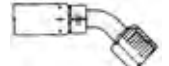

PART NUMBER	SIZE	QTY/BX	LIST PRICE
BSZ04UL64	-4 HOSE X 1/4 TUBE	5	
BSZ04UL66	-4 HOSE X 3/8 TUBE	5	
BSZ06UL66	-6 HOSE X 3/8 TUBE	5	
BSZ06UL68	-6 HOSE X 1/2 TUBE	5	
BSZ08UL68	-8 HOSE X 1/2 TUBE	5	
BSZ08UL70	-8 HOSE X 5/8 TUBE	2	
BSZ10UL70	-10 HOSE X 5/8 TUBE	2	
BSZ10UL72	-10 HOSE X 3/4 TUBE	2	
BSZ12UL72	-12HS X 3/4 TUBE	2	
BSZ16UL76	-16 HOSE X 1 TUBE	2	

### COL-CRIMP SEAL LOCK 90° SHORT EL FEM SWIVEL

U-SERIES FITTING

Line: 881-37

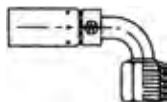

PART NUMBER	SIZE	QTY/BX	LIST PRICE
BTD04UA24	-4 HOSE X 1/4 TUBE	5	
BTD04UA26	-4 HOSE X 3/8 TUBE	5	
BTD06UA24	-6 HOSE X 1/4 TUBE	5	
BTD06UA26	-6 HOSE X 3/8 TUBE	5	
BTD06UA28	-6 HOSE X 1/2 TUBE	5	
BTD08UA26	-8 HOSE X 3/8 TUBE	5	
BTD08UA28	-8 HOSE X 1/2 TUBE	5	
BTD10UA30	-10 HOSE X 5/8 TUBE	2	
BTD10UA32	-10 HOSE X 3/4 TUBE	2	
BTD12UA32	-12 HOSE X 3/4 TUBE	5	
BTD16UA36	-16 HOSE X 1 TUBE	2	
BTD20UA40	-20 HOSE X 1 1/4 TB	2	

### COL-CRIMP 90° SWV ELBOW U SERIES FITT

SEAL-LOCK MED/LNG TANG

Line: 881-38



PART NUMBER	SIZE	QTY/BX	LIST PRICE
BTE04UA64	-4HSE X 1/4 T LNG	5	
BTE04UJ34	-4 HSE X 1/4T MED	5	
BTE04UJ36	-4 HSE X 3/8T MED	5	
BTE06UA66	-6HSE X 3/8 T LNG	5	
BTE06UJ36	-6 HSE X 3/8T MED	5	
BTE06UJ38	-6 HSE X 1/2T MED	5	
BTE08UA68	-8HSE X 1/2 T LNG	2	
BTE08UJ36	-8HSE X 3/8 T MED	2	
BTE10UA70	-10HSE X 5/8T LNG	2	
BTE12UA72	-12HS X 3/4T-LONG	2	
BTE12UJ40	-12HS X 5/8T MEDIUM	2	
BTE16UJ46	-16HS X 1T MEDIUM	1	
BTE20UA80	-20HS X 1 1/4T LONG	1	

### FEMALE SEAL-LOK SWIV MED 90° ELBOW

71 SERIES FITTING - HI-PRES CRIMP

Line: 881-39

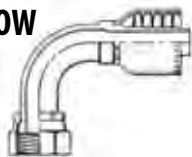

PART NUMBER	SIZE	QTY/BX	LIST PRICE
BGL1J5711010	-10 HSE X -10 S/L	2	
BGL1J5711212	-12 HSE X -12 S/L	1	

### MALE PIPE CRMP FITT {77C HS}

71 SERIES FITTING HI-PRES

Line: 881-40



PART NUMBER	SIZE	QTY/BX	LIST PRICE
AUZ1017166	-6 X 3/8 MPT	4	
AUZ10171128	-8 X 3/4 MPT	2	
AUZ1017188	-8 X 1/2 MPT	4	
AUZ101711212	-12 X 3/4 MPT	2	
AUZ101711612	-16 X 3/4 MPT	2	
AUZ101711616	-16 X 1MPT	2	
AUZ101712016	-20 X 1 MPT	1	
AUZ101712020	-20 X 1 1/4 MPT	1	
AUZ101712424	-24 X 1 1/2 MPT	1	
AUZ101713232	-32 X 2ID	1	

### JIC MALE RIGID CRMP FITT {77C HS}

71 SERIES FITTING HI-PRES

Line: 881-41



PART NUMBER	SIZE	QTY/BX	LIST PRICE
AVD1037166	-6 X 3/8 ML JIC	4	
AVD1037186	-6 X 1/2 ML JIC	4	
AVD10371108	-8 X 5/8 ML JIC	4	
AVD1037188	-8 X 1/2 ML JIC	4	
AVD103711212	-12 X 3/4 ML JIC	2	
AVD103711412	-12 X 7/8 ML JIC	2	
AVD103711612	-12 X 1 ML JIC	2	
AVD103711616	-16 X 1 ML JIC	2	
AVD103712020	-20 X 1 1/4 ML JIC	1	

### O-RING STRA CRMP FIT {77C HS}

71 SERIES FITTING - HI-PRES

Line: 881-42



PART NUMBER	SIZE	QTY/BX	LIST PRICE
AVE10571108	-8 X 7/8-14 ORT	4	
AVE1057188	-8 X 3/4-16 ORT	4	
AVE105711212	-12 X 1 1/16-12 ORT	2	
AVE105711616	-16 X 1 5/16-12 ORT	2	



**CALL - 1 (800) 723-2826**

## 71 SERIES STRAIGHT FEMALE SWIVEL JIC

CRIMP FITTING - FOR 77C HOSE HI-PRES

Line: 881-43



PART NUMBER	SIZE	QTY/BX	LIST PRICE
AVF1067166	-6 X 3/8 FE JIC	4	
AVF1067186	-6 X 1/2 FE JIC	4	
AVF1067188	-8 X 1/2 FE JIC	4	
AVF10671108	-8 X 5/8 FE JIC	4	
AVF10671128	-8 X 3/4 FE JIC	4	
AVF106711212	-12 X 3/4 FE JIC	2	
AVF106711412	-12 X 7/8 FE JIC	2	
AVF106711612	-12 X 1 FE JIC	2	
AVF106711216	-16 X 3/4 FE JIC	2	
AVF106711616	-16 X 1 FE JIC	2	
AVF106712016	-16 X 1 1/4 FE JIC	2	
AVF106712020	-20 X 1 1/4 FE JIC	1	
AVF106712420	-20 X 1 1/2 FE JIC	1	
AVF106712424	-24 X 1 1/2 FE JIC	1	
AVF106713232	-32 X 2 FE JIC	1	

## 71 SERIES FEMALE 45° SWIVEL JIC

CRIMP FITTING - FOR 77C HOSE HI-PRES

Line: 881-44



PART NUMBER	SIZE	QTY/BX	LIST PRICE
AVG1377166	-6 X 3/8 FE JIC	4	
AVG1377188	-8 X 1/2 FE JIC	4	
AVG13771108	-8 X 5/8 FE JIC	4	
AVG137711212	-12 X 3/4 FE JIC	2	
AVG137711616	-16 X 1 FE JIC	2	
AVG137712020	-20 X 1 1/4 FE JIC	1	

## 71 SERIES FEMALE 90° JIC

CRIMP FITTING - FOR 77C HOSE HI-PRES

Line: 881-45

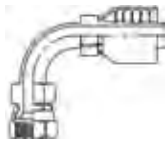

PART NUMBER	SIZE	QTY/BX	LIST PRICE
AVH1397166	-6 X 3/8 FE JIC	4	
AVH1397188	-8 X 1/2 FE JIC	4	
AVH13971108	-8 X 5/8 FE JIC	4	
AVH139711212	-12 X 3/4 FE JIC	2	
AVH139711616	-16 X 1 FE JIC	2	
AVH139712020	-20 X 1 1/4 FE JIC	1	
AVH139712424	-24 X 1 1/2 FE JIC	1	

## 71 SERIES 90° FLNG ELBOW SAE/61

77C HS CRIMP FITTING HI-PRES

Line: 881-46



PART NUMBER	SIZE	QTY/BX	LIST PRICE
AVJ1197188	-8 X 1/2 FLANGE	4	
AVJ11971128	-8 X 3/4 FLANGE	4	
AVJ119711212	-12 X 3/4 FLANGE	2	
AVJ119711612	-12 X 1 FLANGE	2	
AVJ119711616	-16 X 1 FLANGE	2	
AVJ119712016	-16 X 1 1/4 FLANGE	1	
AVJ119711620	-20 X 1 FLANGE	1	
AVJ119712020	-20 X 1 1/4 FLANGE	1	
AVJ119712420	-20 X 1 1/2 FLANGE	1	
AVJ119712424	-24 X 1 1/2 FLANGE	1	
AVJ119713224	-24 X 2 FLANGE	1	
AVJ119713232	-32 X 2 FLANGE	1	
AVJ119714032	-32 X 2 1/2 FLANGE	1	

## 71 SERIES FLNG SRT SAE/61

77C HS CRIMP FITTING HI-PRES

Line: 881-47

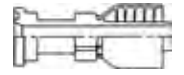

PART NUMBER	SIZE	QTY/BX	LIST PRICE
AVK11571128	-8 X 3/4 FLANGE	4	
AVK1157188	-8 X 1/2 FLANGE	4	
AVK115711212	-12 X 3/4 FLANGE	2	
AVK115711612	-12 X 1 FLANGE	2	
AVK115712012	-12 X 1 1/4 FLANGE	2	
AVK115711616	-16 X 1 FLANGE	2	
AVK115712016	-16 X 1 1/4 FLANGE	2	
AVK115712020	-20 X 1 1/4 FLANGE	1	
AVK115712420	-20 X 1 1/2 FLANGE	1	
AVK115712424	-24 X 1 1/2 FLANGE	1	
AVK115713224	-24 X 2 FLANGE	1	
AVK115713232	-32 X 2 FLANGE	1	
AVK115714032	-32 X 2 1/2 FLANGE	1	

## 71 SERIES FLNG 45° ELBOW SAE/61

77C HS CRIMP FITTING HI-PRES

Line: 881-48



PART NUMBER	SIZE	QTY/BX	LIST PRICE
AVL11771168	-8 X 1 FLANGE	4	
AVL117711212	-12 X 3/4 FLANGE	2	
AVL117711612	-12 X 1 FLANGE	2	
AVL117711616	-16 X 1 FLANGE	2	
AVL117712016	-16 X 1 1/4 FLANGE	2	
AVL117712020	-20 X 1 1/4 FLANGE	1	
AVL117712420	-20 X 1 1/2 FLANGE	1	
AVL117712424	-24 X 1 1/2 FLANGE	1	
AVL117713224	-24 X 2 FLANGE	1	
AVL117713232	-32 X 2 FLANGE	1	

**71 STRAIGHT 62 FLANGE**

77C HS CRIMP FITTING HI-PRES

Line: 881-49

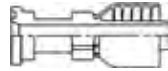

PART NUMBER	SIZE	QTY/BX	LIST PRICE
<b>AVM16A711212</b>	-12 X 3/4 FLANGE	2	
<b>AVM16A711616</b>	-16 X 1 FLANGE	2	
<b>AVM16A712016</b>	-16 X 1 1/4 FLANGE	2	
<b>AVM16A712020</b>	-20 X 1 1/4 FLANGE	1	
<b>AVM16A712424</b>	-24 X 1 1/2 FLANGE	1	
<b>AVM16A713232</b>	-32 X 2 FLANGE	1	

**71 45° ELBOW #62 FLANGE**

77C HS CRIMP FITTING HI-PRES

Line: 881-50



PART NUMBER	SIZE	QTY/BX	LIST PRICE
<b>AVN16F711212</b>	-12 X 3/4 FLANGE	2	
<b>AVN16F711616</b>	-16 X 1 FLANGE	2	
<b>AVN16F712020</b>	-20 X 1 1/4 FLANGE	1	
<b>AVN16F712424</b>	-24 X 1 1/2 FLANGE	1	
<b>AVN16F713232</b>	-32 X 2 FLANGE	1	

**71 SERIES 90° ELB #62 FLANGE**

77C HS CRIMP FITTING HI-PRES

Line: 881-51



PART NUMBER	SIZE	QTY/BX	LIST PRICE
<b>AVP16N711212</b>	-12 X 3/4 FLANGE	2	
<b>AVP16N711616</b>	-16 X 1 FLANGE	2	
<b>AVP16N712016</b>	-16 X 1 1/4 FLANGE	2	
<b>AVP16N712020</b>	-20 X 1 1/4 FLANGE	1	
<b>AVP16N712424</b>	-24 X 1 1/2 FLANGE	1	
<b>AVP16N713232</b>	-32 X 2 FLANGE	1	

**116/22.5° 61 SERIES FLANGE ELB #71 CRIMP**

77C HOSE CRIMP FITTING HI-PRES

Line: 881-52



PART NUMBER	SIZE	QTY/BX	LIST PRICE
<b>BGE116711212</b>	3/4 HSE X 3/4 FLANGE	2	
<b>BGE116711612</b>	3/4 HSE X 1 FLANGE	2	
<b>BGE116711616</b>	1 HSE X 1 FLANGE	1	
<b>BGE116712020</b>	1-1/4 HSE X 1-1/4 FLANGE	1	
<b>BGE116712016</b>	1 HSE X 1-1/4 FLANGE	1	
<b>BGE116712424</b>	1-1/2 HSE X 1-1/2 FLANGE	1	
<b>BGE116713232</b>	2 HSE X 2 FLANGE	1	
<b>BGE116714032</b>	2 HSE X 2-1/2 FLANGE	1	

**126/61 FLANGE 30° ELBOW**

#71 SERIES CRIMP FITTING HI-PRES

Line: 881-53

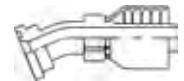

PART NUMBER	SIZE	QTY/BX	LIST PRICE
<b>BGF126711212</b>	3/4 HSE X 3/4 FLANGE	1	
<b>BGF126711616</b>	1 HSE X 1 FLANGE	1	
<b>BGF126712016</b>	1 HSE X 1 1/4 FLANGE	1	
<b>BGF126712020</b>	1 1/4 HSE X 1 1/4 FLANGE	1	
<b>BGF126712424</b>	1 1/2 HSE X 1 1/2 FLANGE	1	
<b>BGF126713224</b>	1 1/2 HSE X 2 FLANGE	1	
<b>BGF126713232</b>	2 HSE X 2 FLANGE	1	

**118/61 FLANGE 67.5° ELBOW**

#71 SERIES CRIMP FITTING HI-PRES

Line: 881-54



PART NUMBER	SIZE	QTY/BX	LIST PRICE
<b>BGG11871128</b>	1/2 HSE X 3/4 FLANGE	1	
<b>BGG118711212</b>	3/4 HSE X 3/4 FLANGE	1	
<b>BGG118711612</b>	3/4 HSE X 1 FLANGE	1	
<b>BGG118711616</b>	1 HSE X 1 FLANGE	1	
<b>BGG118712020</b>	1 1/4 HSE X 1 1/4 FLANGE	1	
<b>BGG118712424</b>	1 1/2 HSE X 1 1/2 FLANGE	1	
<b>BGG118713224</b>	1 1/2 HSE X 2 FLANGE	1	
<b>BGG118713232</b>	2 HSE X 2 FLANGE	1	

**1JS71 FEM SEALOK SWIVEL STRAIGHT**

#71 SERIES CRIMP FITTING HI-PRES

Line: 881-55

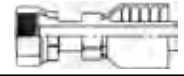

PART NUMBER	SIZE	QTY/BX	LIST PRICE
<b>BGH1JS7166</b>	-6 HSE X -6 S/L	2	
<b>BGH1JS7188</b>	-8 HSE X -8 S/L	2	
<b>BGH1JS711010</b>	-10 HOSE X -10 S/L	2	
<b>BGH1JS711012</b>	-12 HSE X -10 S/L	2	
<b>BGH1JS711212</b>	-12 HSE X -12 S/L	1	
<b>BGH1JS711612</b>	-12 HSE X -16 S/L	1	
<b>BGH1JS711616</b>	-16 HSE X -16 S/L	1	
<b>BGH1JS712020</b>	-20 HSE X -20 S/L	1	
<b>BGH1JS712424</b>	-24 HSE X -24 S/L	1	

**1J771 FEM SEALOK SWV 45° ELBOW**

#71 SERIES CRIMP FITTING HI-PRES

Line: 881-56

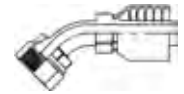

PART NUMBER	SIZE	QTY/BX	LIST PRICE
<b>BGJ1J77166</b>	-6 HSE X -6 S/L	2	
<b>BGJ1J77188</b>	-8 HSE X -8 S/L	2	
<b>BGJ1J7711212</b>	-12 HSE X -12 S/L	1	
<b>BGJ1J7711616</b>	-16 HSE X -16 S/L	1	
<b>BGJ1J7712020</b>	-20 HSE X -20 S/L	1	
<b>BGJ1J7712424</b>	-24 HSE X -24 S/L	1	



## 1J971 FEM SWV SEALOK SHORT 90° ELBOW

#71 SERIES CRIMP FITTING HI-PRES

Line: 881-57

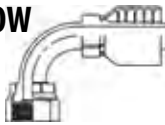

PART NUMBER	SIZE	QTY/BX	LIST PRICE
BGK1J97166	-6 HSE X -6 S/L	2	
BGK1J97188	-8 HSE X -8 S/L	2	
BGK1J9711010	-10 HSE X -10 S/L	1	
BGK1J9711012	-12 HSE X -10 S/L	1	
BGK1J9711212	-12 HSE X -12 S/L	1	
BGK1J9711616	-16 HSE X -16 S/L	1	
BGK1J9712020	-20 HSE X -20 S/L	1	
BGK1J9712424	-24 HSE X -24 S/L	1	

## PARKRIMP 1L943 FE JIC MED 90° ELBOW

43 SERIES CRIMP FITTING

Line: 881-63



PART NUMBER	SIZE	QTY/BX	LIST PRICE
BPY1L94344	-4 JIC X -4 HSE	5	
BPY1L94366	-6 JIC X -6 HSE	5	
BPY1L94386	8 JIC X -6 HSE	4	
BPY1L94388	8 JIC X -8 HSE	4	
BPY1L943108	10 JIC X -8 HSE	2	
BPY1L9431212	12 JIC X -12 HSE	2	
BPY1L9431616	16 JIC X -16 HSE	2	

## PARKRIMP FEMALE NPSM PIPE SWIVL

HOSE FITTING 43 SERIES CRIMP

Line: 881-64

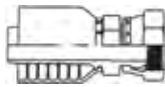

PART NUMBER	SIZE	QTY/BX	LIST PRICE
AYS10743X44	-4 X 1/4 NPSM	4	
AYS10743X66	-6 X 3/8 NPSM	4	
AYS10743X88	-8 X 1/2 NPSM	2	
AYS10743X1212	-12 X 3/4 NPSM	2	
AYS10743X1616	-16 X 1NPSM	2	
AYS10743X2020	-20 X 1 1/4 NPSM	1	

**NOTE: PARKRIMP 43 SERIES FITTINGS APPLIED TO 2 & 1 WIRE BRAND HYDRAULIC HOSES ARE FOR MEDIUM PRESSURE APPLICATIONS. HOSE FITTING ASSEMBLY CAN ONLY BE MACHINE CRIMPED.**

## PARKRIMP MALE PIPE THREAD CRIMP

HOSE FITTING 43 SERIES

Line: 881-65

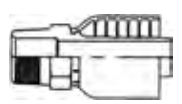

PART NUMBER	SIZE	QTY/BX	LIST PRICE
AKS10143X2X4	-4 X 1/8MPT (10143-2-4)	5	
AKS10143X4X4	-4 X 1/4MPT (10143-4-4)	5	
AKS10143X6X4	-4 X 3/8MPT (10143-6-4)	5	
AKS10143X6X5	-5 X 3/8MPT (10143-6-5)	1	
AKS10143X4X6	-6 X 1/4MPT (10143-4-6)	5	
AKS10143X6X6	-6 X 3/8MPT (10143-6-6)	5	
AKS10143X6X6C	-6 X 3/8MPT 316SS	2	
AKS10143X8X6	-6 X 1/2MPT (10143-8-6)	5	
AKS10143X6X8	-8 X 3/8MPT (10143-6-8)	5	
AKS10143X8X8	-8 X 1/2MPT (10143-8-8)	5	
AKS10143X12X8	-8 X 3/4MPT (10143-128)	2	
AKS10143X6X10	-10 X 3/8 MPT	2	
AKS10143X8X10	-10 X 1/2MPT (10143-810)	2	
AKS10143X1210	-10 X 3/4MPT (101431210)	2	
AKS10143X8X12	-12 X 1/2MPT (10143-812)	2	
AKS10143X1212	-12 X 3/4MPT (101431212)	2	
AKS10143X1612	-12 X 1 MPT (101431612)	2	
AKS10143X1216	-16 X 3/4MPT (101431216)	2	
AKS10143X1616	-16 X 1MPT (10143-1616)	2	
AKS10143X2020	20 X 1-1/4MPT(101432020)	2	
AKS10143X2424	-24 X 1 1/2	2	
AKS10143X3232	-32 HSE X 2MPT	1	

## PARKRIMP MALE 37° JIC

HOSE FITTING 43 SERIES CRIMP

Line: 881-66



PART NUMBER	SIZE	QTY/BX	LIST PRICE
AKT10343X4X4	-4 X 1/4 JIC (10343-4-4)	5	
AKT10343X5X4	-4 X 5/16 JIC	5	
AKT10343X6X4	-4 X 3/8 JIC	5	
AKT1LB43X6X6	-6 X 3/8 BULKHEAD	5	
AKT10343X6X6	-6 X 3/8 JIC	5	
AKT10343X5X6	-6 X 5/16	5	
AKT10343X8X6	-6 X 1/2 JIC (10343-8-6)	5	
AKT10343X8X8	-8 X 1/2 JIC (10343-8-8)	5	
AKT10343X10X8	-8 X 5/8 JIC (10343-108)	5	
AKT10343X12X8	-8 X 3/4 JIC (10343-128)	2	
AKT10343X1010	10 X 5/8 JIC (10343-1010)	2	
AKT10343X1210	10 X 3/4 JIC (10343-1210)	2	
AKT10343X1212	12 X 3/4 JIC (10343-1212)	2	
AKT10343X1412	-12 X 7/8 JIC	2	
AKT10343X1612	12 X 1JIC 10143-16-12)	2	
AKT10343X1616	-16 X 1JIC (10343-1616)	2	
AKT10343X2020	20 X 1 1/4JIC(103432020)	2	

### PARKRIMP O-RING STRAIGHT THREAD

HOSE FITTING 43 SERIES CRIMP

Line: 881-67

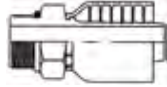

PART NUMBER	SIZE	QTY/BX	LIST PRICE
AKV10543X4X4	-4 X 1/4ST (10543-4-4)	5	
AKV10543X6X4	-4 X 3/8ST (10543-6-4)	5	
AKV10543X6X6	-6 X 3/8ST (10543-6-6)	5	
AKV10543X8X6	-6 X 1/2ST (10543-8-6)	5	
AKV10543X8X8	-8 X 1/2ST (10543-8-8)	5	
AKV10543X10X8	8 X 5/8ST (10543-10-8)	2	
AKV10543X1210	10 X 3/4ST (10543-12-10)	2	
AKV10543X1212	-12 X 3/4ST (10543-1212)	2	
AKV10543X1616	-16 X 1ST (10543-1616)	2	
AKV10543X2020	-20 X 1 1/4ST(105432020)	2	

### PARKRIMP 37°/45° FEMALE SWIVEL

HOSE FITTING 43 SERIES CRIMP

Line: 881-68



PART NUMBER	SIZE	QTY/BX	LIST PRICE
AKW10643X4X4	-4 X 1/4 (10643-4-4)	5	
AKW10643X5X4	-4 X 5/16 (10643-5-4)	5	
AKW10643X6X4	-4 X 3/8 37°	5	
AKW10843X6X4	-4 X 3/8 45°	5	
AKW10643X6X5	-5 X 3/8 JIC	5	
AKW10643X4X6	-6 X 1/4 (10643-4-6)	5	
AKW10643X5X6	-6 X 5/16 37°/45°	5	
AKW10643X6X6	-6 X 3/8 (10643-6-6)	5	
AKW10843X6X6	-6 X 3/8 45°	5	
AKW10643X8X6	-6 X 1/2 (10643-8-6)	5	
AKW10643X10X6	-6 X 5/8 (10643-10-6)	2	
AKW10643X6X8	-8 X 3/8 (10643-6-8)	5	
AKW10643X8X8	-8 X 1/2 (10643-8-8)	5	
AKW10643X10X8	-8 X 5/8 (10643-10-8)	2	
AKW10643X12X8	-8 X 3/4 (10643-12-8)	2	
AKW10643X8X10	-10 X 1/2 37°/45°	2	
AKW10643X1010	-10 X 5/8 (10643-1010)	2	
AKW10643X1210	-10 X 3/4 (10643-1210)	2	
AKW10643X8X12	-12 X 1/2 37°/45°	2	
AKW10643X1012	-12 X 5/8 (10643-1012)	2	
AKW10643X1212	-12 X 3/4 (10643-1212)	2	
AKW10843X1212	-12 X 3/4 45°	2	
AKW10643X1412	-12 X 7/8 37°/45°	2	
AKW10643X1612	-12 X 1 (10643-1612)	2	
AKW10643X1216	-16 X 3/4 37°	2	
AKW10643X1616	-16 X 1 (10643-1616)	2	
AKW10643X2016	-16 X 1 1/4 37°	2	
AKW10643X2020	-20X1 1/4 (10643-2020)	2	
AKW10643X2424	-24 HOSE X 1 1/2	1	
AKW10643X3232	-32 X 2 (10643X3232)	1	

### PARKRIMP FERRUL-FIX SAE FLARELESS

HOSE FITTING 43 SERIES CRIMP

Line: 881-69



PART NUMBER	SIZE	QTY/BX	LIST PRICE
AKX11143X5X6	-6 X 5/16 T	5	
AKX11143X6X6	-6 X 3/8 T	5	
AKX11143X10X8	-8 X 5/8 T	2	
AKX11143X8X8	-8 X 1/2 T	5	
AKX11143X1212	-12 X 3/4 T	2	

### PARKRIMP SAE FLARELESS SWIVEL FITT

HOSE FITTING 43 SERIES CRIMP

Line: 881-70



PART NUMBER	SIZE	QTY/BX	LIST PRICE
AKY11243X6X6	-6 X 9/16-18	5	
AKY11243X8X6	-6 X 3/4-16	5	
AKY11243X8X8	-8 X 3/4-16	5	

### PARKRIMP MALE PIPE SWIVEL

HOSE FITTING 43 SERIES CRIMP

Line: 881-71



PART NUMBER	SIZE	QTY/BX	LIST PRICE
AKZ11343X4X4	-4X1/4SMPT (11343-4-4)	5	
AKZ11343X6X4	-4 X 3/8 SMPT	2	
AKZ11343X4X6	-6X1/4SMPT (11343-4-6)	5	
AKZ11343X6X6	-6X3/8SMPT (11343-6-6)	5	
AKZ11343X8X6	-6X1/2SMPT (11343-8-6)	5	
AKZ11343X6X8	-8X3/8SMPT (11343-6-8)	5	
AKZ11343X8X8	-8X1/2SMPT (11343-8-8)	5	
AKZ11343X1212	-12X3/4SMPT (113431212)	2	
AKZ11343X1616	-16X1SMPT (113431616)	2	

### PARKRIMP STRAIGHT FLANGE FITT SAE 61

HOSE FITTING 43 SERIES CRIMP

Line: 881-72



PART NUMBER	SIZE	QTY/BX	LIST PRICE
ALD11543X8X8	-8 X 1/2 FLANGE	5	
ALD1K543X1010	-10 X 5/8 F KOMATSU	1	
ALD11543X1212	-12 X 3/4 FLANGE	5	
ALD11543X1612	-12 X 1 FLANGE	5	
ALD11543X1616	-16 X 1 FLANGE	5	
ALD11543X2016	-16 X 1 1/4 FLANGE	5	
ALD11543X2020	-20 X 1 1/4 FLANGE	1	
ALD11543X3220	-20 X 2 FLANGE	5	

### PARKRIMP 45° FLANGE ELBOW SAE 61

HOSE FITTING 43 SERIES CRIMP

Line: 881-73



PART NUMBER	SIZE	QTY/BX	LIST PRICE
ALE11743X1212	-12 X 3/4 FLANGE	2	
ALE11743X1616	-16 X 1 FLANGE	2	
ALE11743X2016	-16 X 1 1/4 FLANGE	2	
ALE11743X2020	-20 X 1 1/4 FLANGE	1	

### PARKRIMP 90° FLANGE ELBOW SAE 61

HOSE FITTING 43 SERIES CRIMP

Line: 881-74

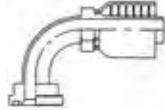

PART NUMBER	SIZE	QTY/BX	LIST PRICE
ALF11943X12X8	-8 X 3/4 FLANGE	2	
ALF11943X8X8	-8 X 1/2 FLANGE	1	
ALF11943X1212	-12 X 3/4 FLANGE	1	
ALF11943X1612	-12 X 1 FLANGE	1	
ALF11943X1616	-16 X 1 FLANGE	1	
ALF11943X2016	-16 X 1 1/4 FLANGE	1	
ALF11943X2020	-20 X 1 1/4 FLANGE	1	
ALF11943X2420	-20 X 1 1/2 FLANGE	2	

### PARKRIMP INVERTED STRAIGHT SWIVEL

HOSE FITTING 43 SERIES CRIMP

Line: 881-75

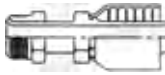

PART NUMBER	SIZE	QTY/BX	LIST PRICE
ALG12843X4X4	-4 X 1/4 ML IF	5	
ALG12843X4X6	-6 X 1/4 ML IF	5	
ALG12843X5X4	-4 X 5/16 ML IF	5	
ALG12843X5X6	-6 X 5/16 ML IF	5	
ALG12843X6X6	-6 X 3/8 ML IF	5	
ALG12843X8X8	-8 X 1/2 ML IF	5	

### PARKRIMP JIC 37° SWIVEL 45° ELBOW

HOSE FITTING 43 SERIES CRIMP

Line: 881-76



PART NUMBER	SIZE	QTY/BX	LIST PRICE
ALH13743X4X4	-4 X 1/4 (13743-4-4)	5	
ALH13743X6X4	-4 X 3/8 JIC	5	
ALH13743X6X6	-6 X 3/8 (13743-6-6)	5	
ALH13743X8X6	-6 X 1/2 JIC	5	
ALH13743X8X8	-8 X 1/2 (13743-8-8)	5	
ALH13743X10X8	-8 X 5/8 JIC	2	
ALH13743X1010	-10 X 5/8 JIC	2	
ALH13743X1210	-10 X 3/4 JIC (137431210)	2	
ALH13743X1212	-12 X 3/4 JIC (137431212)	2	
ALH13743X1616	-16 X 1 JIC (13743-1616)	2	

### PARKRIMP JIC 37° SWIVEL 90° ELBOW

HOSE FITTING 43 SERIES CRIMP

Line: 881-77

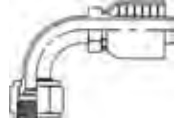

PART NUMBER	SIZE	QTY/BX	LIST PRICE
ALJ13943X4X4	-4 X 1/4 (13943-4-4)	5	
ALJ13943X5X4	-4 X 5/16 JIC	5	
ALJ13943X6X4	-4 X 3/8 JIC	5	
ALJ13943X4X6	-6 X 1/4 JIC	5	
ALJ13943X6X6	-6 X 3/8 (13943-6-6)	5	
ALJ13943X8X6	-6 X 1/2 (13943-8-6)	5	
ALJ13943X6X8	-8 X 3/8 JIC	1	
ALJ13943X8X8	-8 X 1/2 (13943-8-8)	5	
ALJ13943X10X8	-8 X 5/8 JIC	2	
ALJ13943X12X8	-8 X 3/4 JIC	1	
ALJ13943X1010	-10 X 5/8 JIC	2	
ALJ13943X1210	-10 X 3/4 (13943-1210)	1	
ALJ13943X1212	-12 X 3/4 (13943-1212)	2	
ALJ13943X1616	-16 X 1 (13943-1616)	2	
ALJ13943X2020	-20 X 1 1/4 JIC	2	

### PARKRIMP JIC 37° LG 90° ELBOW

HOSE FITTING 43 SERIES CRIMP

Line: 881-78



PART NUMBER	SIZE	QTY/BX	LIST PRICE
ALK14143X4X4	-4 X 1/4 JIC LONG	5	
ALK14143X5X4	-4 X 5/16 JIC LONG	5	
ALK14143X6X6	-6 X 3/8 JIC LONG	5	
ALK14143X8X6	-6 X 1/2 JIC LONG	5	
ALK14143X8X8	-8 X 1/2 JIC LONG	5	
ALK14143X10X8	-8 X 5/8 JIC LONG	2	
ALK14143X1010	-10 X 5/8 JIC LONG	2	
ALK14143X1212	-12 X 3/4 JIC LONG	2	
ALK14143X1412	-12 X 7/8 JIC LONG	2	
ALK14143X1616	-16 X 1 JIC LONG	2	

### PARKRIMP INV FLARE SWIV 45° ML ELBOW

HOSE FITTING 43 SERIES CRIMP

Line: 881-79



PART NUMBER	SIZE	QTY/BX	LIST PRICE
ALL16743X4X4	-4 X 1/4 IF	5	
ALL16743X4X6	-6 X 1/4 IF	5	
ALL16743X5X4	-4 X 5/16 IF	5	
ALL16743X5X6	-6 X 5/16 IF	5	
ALL16743X6X6	-6 X 3/8 IF	5	
ALL16743X8X8	-8 X 1/2 IF	2	

**PARKRIMP INV FLARE 90° SWIV ML ELBOW**

HOSE FITTING 43 SERIES CRIMP

Line: 881-80

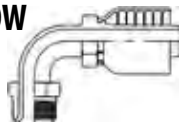

PART NUMBER	SIZE	QTY/BX	LIST PRICE
ALM16943X4X4	-4 X 1/4 IF	5	
ALM16943X5X4	-4 X 5/16 IF	5	
ALM16943X4X6	-6 X 1/4 IF	5	
ALM16943X5X6	-6 X 5/16 IF	5	
ALM16943X6X6	-6 X 3/8 IF	5	
ALM16943X8X8	-8 X 1/2 IF	2	

**PARKRIMP 45° SAE FEM SWV 45° ELBOW**

HOSE FITTING 43 SERIES CRIMP

Line: 881-81



PART NUMBER	SIZE	QTY/BX	LIST PRICE
ALN17743X4X6	-6 X 1/4 SAE	5	

**PARKRIMP 45° SAE FEM SWV 90° ELBOW**

HOSE FITTING 43 SERIES CRIMP

Line: 881-82

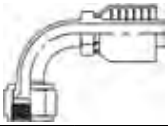

PART NUMBER	SIZE	QTY/BX	LIST PRICE
ALP17943X6X6	-6 X 3/8 SAE	5	

**PARKRIMP 1/2 FLANGE KIT**

SAE 61 & 62 STYLE

Line: 881-84



PART NUMBER	SIZE	QTY/BX	LIST PRICE
ALS51H8	1/2 FLANGE SIZE #61	1	
ALSHFH12	3/4 FLANGE SIZE #62	1	
ALS51H12	3/4 FLANGE SIZE#61	1	
ALSHFH16	1 FLANGE SIZE #62	1	
ALS51H16	1 FLANGE SIZE #61	1	
ALSHFH20	1 1/4 FLANGE SIZE #62	1	
ALS51H20	1 1/4 FLANGE SIZE #61	1	
ALSHFH24	1 1/2 FLANGE SIZE #62	1	
ALS51H24	1 1/2 FLANGE SIZE #61	1	
ALSHFH32	2 FLANGE SIZE #62	1	
ALS51H32	2 FLANGE SIZE #61	1	

**PARKRIMP FULL FLANGE KIT**

SAE 61 & 62 STYLE

Line: 881-85



PART NUMBER	SIZE	QTY/BX	LIST PRICE
ALT5151HK8	1/2 FLANGE SIZE #61	1	
ALTHFHFK12	3/4 FLANGE SIZE #62	1	
ALT5151HK12	3/4 FLANGE SIZE#61	1	
ALTHFHFK16	1 FLANGE SIZE #62	1	
ALT5151HK16	1 FLANGE SIZE #61	1	
ALTHFHFK20	1 1/4FLANGE SIZE #62	1	
ALT5151HK20	1 1/4 FLANGE SIZE #61	1	
ALTHFHFK24	1 1/2FLANGE SIZE #62	1	
ALT5151HK24	1 1/2 FLANGE SIZE #61	1	
ALTHFHFK32	2 FLANGE SIZE #62	1	
ALT5151HK32	2 FLANGE SIZE #61	1	
ALT5151HK40	2 1/2FLANGE SIZE #61	1	

**PARKRIMP SEAL-LOK FEMALE SWIVEL**

HOSE FITTING 43 SERIES CRIMP

Line: 881-86



PART NUMBER	SIZE	QTY/BX	LIST PRICE
ATV1JS4344	-4 X 1/4T	5	
ATV1JS4364	-4 X 3/8T	5	
ATV1JS4346	-6 X 1/4T	5	
ATV1JS4366	-6 X 3/8T	5	
ATV1JS4386	-6 X 1/2T	5	
ATV1JS43106	-6 X 5/8T	2	
ATV1JS4368	-8 X 3/8T	5	
ATV1JS4388	-8 X 1/2T	5	
ATV1JS43108	-8 X 5/8T	2	
ATV1JS43128	-8 X 3/4T	2	
ATV1JS43810	-10 X 1/2 T	2	
ATV1JS431010	-10 X 5/8	2	
ATV1JS431210	-10 X 3/4 T	2	
ATV1JS431012	-12 X 5/8 T	2	
ATV1JS431212	-12 X 3/4T	2	
ATV1JS431612	-12 X 1T	2	
ATV1JS431216	-16 X 3/4 T	2	
ATV1JS431616	-16 X 1T	2	
ATV1JS432016	-16 X 1 1/4 T	2	
ATV1JS431620	-20 X 1T	1	
ATV1JS432020	-20 X 1 1/4 T	1	
ATV1JS432424	-24 X 1 1/2T	1	

## PARKRIMP SEAL-LOK CRIMP FITTING

45° FEMALE ELBOW SWIVEL 43 SERIES

Line: 881-87

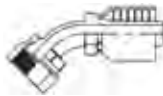

PART NUMBER	SIZE	QTY/BX	LIST PRICE
ATW1J74344	-4 X 1/4T	5	
ATW1J74364	-4 X 3/8T	5	
ATW1J74346	-6 X 1/4T	5	
ATW1J74366	-6 X 3/8T	5	
ATW1J74386	-6 X 1/2T	5	
ATW1J74368	-8 X 3/8T	4	
ATW1J74388	-8 X 1/2T	5	
ATW1J743108	-8 X 5/8	5	
ATW1J743128	-8 X 3/4T	4	
ATW1J743810	-10 X 1/2T	2	
ATW1J7431010	-10 X 5/8	5	
ATW1J7431210	-10 X 3/4T	2	
ATW1J7431012	-12 X 5/8T	2	
ATW1J7431212	-12 X 3/4T	2	
ATW1J7431612	-12 X 1T	2	
ATW1J7431216	-16 X 3/4T	2	
ATW1J7431616	-16 X 1T	2	
ATW1J7432016	-16 X 1 1/4T	2	
ATW1J7431620	-20 X 1T	1	
ATW1J7432020	-20 X 1 1/4T	1	
ATW1J7432420	-20 X 1 1/2T	1	

## PARKRIMP SEAL-LOK CRIMP FITTING

90° FEMALE ELBOW SWIVEL 43 SERIES

Line: 881-88

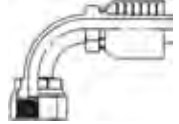

PART NUMBER	SIZE	QTY/BX	LIST PRICE
ATX1J94344	-4 X 1/4T	5	
ATX1J94364	-4 X 3/8T	5	
ATX1J94384	-4 X 1/2T	5	
ATX1J94346	-6 X 1/4T	5	
ATX1J94366	-6 X 3/8T	5	
ATX1J94366SM	-6 X 3/8 SHORT TANG	5	
ATX1J94386	-6 X 1/2T	5	
AXT1J94386	-6 X 1/2T	5	
ATX1J94368	-8 X 3/8T	5	
ATX1J94388	-8 X 1/2T	5	
ATX1J94388SM	-8 X 1/2 SHORT TANG	5	
ATX1J943108	-8 X 5/8T	4	
ATX1J943128	-8 X 3/4T	4	
ATX1J9431010	-10 X 5/8	5	
ATX1J943810	-10 X 1/2T	2	
ATX1J9431210	-10 X 3/4T	2	
ATX1J9431012	-12 X 5/8T	2	
ATX1J9431212	-12 X 3/4T	2	
ATX1J9431612	-12 X 1T	2	
ATX1J9431216	-16 X 3/4T	2	
ATX1J9431616	-16 X 1T	2	
ATX1J9432016	-16 X 1 1/4T	2	
ATX1J9431620	-20 X 1T	1	
ATX1J9432020	-20 X 1 1/4T	1	

## PARKRIMP SEAL-LOK

STRAIGHT CRIMP FITTING 43 SERIES

Line: 881-89

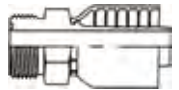

PART NUMBER	SIZE	QTY/BX	LIST PRICE
BBG1JM43X44	1/4T X -4 HOSE(1J0)	5	
BBG1JM43X66	3/8T X -6 HOSE(1J0)	5	
BBG1JM43X86	1/2T X -6 HOSE(1J0)	5	
BBG1JM43X88	1/2T X -8 HOSE(1J0)	5	
BBG1JM43X1010	5/8T X -10 HOSE(1J0)	2	
BBG1JM43X1212	3/4T X -12 HOSE(1J0)	2	
BBG1JM43X1612	1T X -12 HOSE(1J0)	1	
BBG1JM43X1616	1T X -16 HOSE(1J0)	1	
BBG1JM43X2020	1 1/4T X -20HOSE(1J0)	1	

### IMU METRIC FEMALE/JIS

STRAIGHT SWIVEL CRIMP FITTING 43 SERIES

Line: 881-90



PART NUMBER	SIZE	QTY/BX	LIST PRICE
BBH1MU43X44	M14-1.5 X-4 HOSE	4	
BBH1MU43X66	M18-1.5 X -6 HOSE	4	
BBH1MU43X88	M22-1.5 X -8 HOSE	4	
BBH1XU431010	M24-1.5/-10HSE JAP	1	
BBH1XU431212	M30-1.5/-12HSE JAP	1	
BBH1XU431616	M33-1.5/-16HSE JAP	1	

### IDO METRIC MALE STUD

STRAIGHT CRIMP FITTING 43 SERIES

Line: 881-91

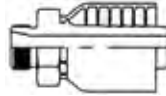

PART NUMBER	SIZE	QTY/BX	LIST PRICE
BBJ1D043X84	M14-1.5/-4HSE/M8TUBE	5	
BBJ1D043X64	M12-1.5/-4HSE/M6TUBE	5	
BBJ1D043X105	M16-1.5/-5HSE/M10TUBE	5	
BBJ1D043X106	M16-1.5X-6HSE(M10T)	5	
BBJ1D043X126	M18-1.5/-6HSE/M12TUBE	5	
BBJ1D043X158	M22-1.5/-8HSE/M15TUBE	4	
BBJ1D043X1810	M26-1.5/-10HS/M18TUBE	4	
BBJ1D043X1812	M26-1.5/-12HS/M18TUBE	4	
BBJ1D043X2212	M30-2.0/-12HS/M22TUBE	2	
BBJ1D043X2816	M36-2.0/-16HS/M28TUBE	2	

### IC3 METRIC STRAIGHT FEMALE/SWIVEL

LIGHT CRIMP CONNECTOR 43 SERIES

Line: 881-92

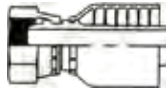

PART NUMBER	SIZE	QTY/BX	LIST PRICE
BBK1C343X64	M12-1.5/-4HSE/M6TUBE	5	
BBK1C343X84	M14-1.5/-4HSE/M8TUBE	5	
BBK1C343X105	M16-1.5/-5HSE/M10TUBE	5	
BBK1C343X106	M16-1.5/-6HSE/M10TUBE	5	
BBK1C343X126	M18-1.5/-6HS/M12TUBE	1	
BBK1C343X158	M22-1.5/-8HSE/M15TUBE	4	
BBK1C343X1810	M26-1.5/-10HS/M18TUBE	4	
BBK1C343X1812	M26-1.5/-12HS/M18TUBE	4	
BBK1C343X2212	M30-2.0/-12HS/M22TUBE	2	
BBK1C343X2816	M36-2.0/-16HS/M28TUBE	2	

### 1J5 PARKRIMP SL/MED 90° ELBOW

FEMALE SWIVEL 43 SERIES

Line: 881-93

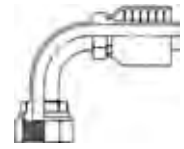

PART NUMBER	SIZE	QTY/BX	LIST PRICE
BCD1J54344	-4 X 1/4T	5	
BCD1J54364	-4 X 3/8T	5	
BCD1J54366	-6 X 3/8T	5	
BCD1J54386	-6 X 1/2T	5	
BCD1J54388	-8 X 1/2T	4	
BCD1J5431010	-10 X 5/8T	2	
BCD1J5431012	-12 X 5/8T	2	
BCD1J5431212	-12 X 3/4T	2	
BCD1J5431616	-16 X 1T	2	
BCD1J5432020	-20 X 1 1/4T	1	

### 1JC FEMALE SHORT SWIVEL SEAL-LOK

STRAIGHT - #43 SERIES CRIMP FITTING

Line: 881-94



PART NUMBER	SIZE	QTY/BX	LIST PRICE
BFE1JC4344	-4 HSE X 9/16 TUBE	5	
BFE1JC4364	-4 HSE X 11/16 TUBE	5	
BFE1JC4365	-5 HSE X 11/16 TUBE	5	
BFE1JC4366	-6 HSE X 11/16 TUBE	5	
BFE1JC4386	-6 HSE X 13/16 TUBE	5	
BFE1JC43108	-8 HSE X 1 TUBE	5	
BFE1JC43128	-8 HSE X 1 3/16 TUBE	5	
BFE1JC4388	-8 HSE X 13/16 TUBE	1	
BFE1JC431010	-10 HSE X 1 TUBE	4	
BFE1JC431210	-10 HSE X 1 3/16 TUBE	4	
BFE1JC431212	-12 HSE X 1 3/16 T	4	
BFE1JC431612	-12 HSE X 1 7/16 T	4	
BFE1JC431616	-16 HSE X 1 7/16 T	2	



CALL - 1 (800) 723-2826

## 1J1 FEMALE SEAL/LOK

SWIVEL 90° LONG ELBOW - #43 SERIES CRIMP FITTING

Line: 881-95



PART NUMBER	SIZE	QTY/BX	LIST PRICE
BFF1J14344	-4 HSE X 9/16 THD	5	
BFF1J14364	-4 HSE X 11/16 THD	5	
BFF1J14366	-6 HSE X 11/16 THD	5	
BFF1J14386	-6 HSE X 13/16 THD	5	
BFF1J14388	-8 HSE X 13/16 THD	4	
BFF1J143108	-8 HSE X 1 THD	4	
BFF1J1431010	-10 HSE X 1 TUBE THD	2	
BFF1J1431012	-12 HSE X 1 THD	2	
BFF1J1431212	-12 HSE X 1 13/16 TH	2	
BFF1J1431616	-16 HSE X 1 7/16 TH	2	
BFF1J1432020	-20 HSE X 1 5/8 THD	1	
BFF1J1432420	-20 HSE X 2 THD	1	

## 1J6 FEMALE SWIVEL SEAL-LOK

22.5° ELBOW - #43 SERIES CRIMP FITTING

Line: 881-96



PART NUMBER	SIZE	QTY/BX	LIST PRICE
BFG1J64388	-8 HSE X 13/16 THD	2	

## IC9 FEMALE METRIC STRAIGHT SWIVEL HVV

#43 SERIES CRIMP FITTING WITH O-RING

Line: 881-97



PART NUMBER	SIZE	QTY/BX	LIST PRICE
BFN1C94384	M16-1.5/-4HSE/M8TUBE	2	
BFN1C943104	M18-1.5/-4HS/M10TUBE	2	
BFN1C943126	M20-1.5/-6HSE/M12TUBE	2	
BFN1C943146	M22-1.5/-6HS/M14TUBE	2	
BFN1C943168	M24-1.5/-8HS/M16TUBE	2	
BFN1C9432010	M30-2.0/-10HS/M20TUBE	2	
BFN1C9432012	M30-2.0/-12HS/M20TUBE	2	
BFN1C9432512	M36-2.0/-12HS/M25TUBE	1	
BFN1C9433016	M42-2.0/-16HS/M30TUBE	1	

## 10C FEMALE METRIC SWIVEL HVV

45° ELBOW - #43 SERIES CRIMP FITT. WITH O-RING

Line: 882-00



PART NUMBER	SIZE	QTY/BX	LIST PRICE
BFP10C43126	-6HSE/M20X1.5/M12TUBE	2	
BFP10C43168	-8HSE/M24X1.5/M16TUBE	2	
BFP10C432010	-10HS/M30-2.0/M20TUBE	1	
BFP10C432512	-12HS/M36-2.0/M25TUBE	1	
BFP10C433016	-16HS/M42-2.0/M30TUBE	1	

## 11C FEMALE METRIC SWIVEL HVV SERIES

90° ELBOW - #43 SERIES CRIMP FITTING WITH O-RING

Line: 882-01

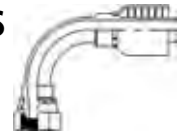

PART NUMBER	SIZE	QTY/BX	LIST PRICE
BFR11C43126	-6HS/M20-1.5/M12TUBE	2	
BFR11C43146	-6HS/M22-1.5/M14TUBE	2	
BFR11C43168	-8HS/M24-1.5/M16TUBE	2	
BFR11C432010	-10HS/M30-2.0/M20TUBE	1	
BFR11C432512	-12HS/M36-2.0/M25TUBE	1	
BFR11C433016	-16HS/M42-2.0/M30TUBE	1	

## IC4 FEMALE METRIC SWIVEL LIGHT SERIES

45° ELBOW - #43 SERIES CRIMP FITTING

Line: 882-02



PART NUMBER	SIZE	QTY/BX	LIST PRICE
BFH1C44384	-4HS/M14-1.5/M8 TUBE	2	
BFH1C443105	-5HS/M16-1.5/M10TUBE	2	
BFH1C443106	-6HS/M16-1.5/M10TUBE	2	
BFH1C443126	-6HS/M18-1.5/M12TUBE	2	
BFH1C443158	-8HS/M22-1.5/M15TUBE	2	
BFH1C4431810	-10HS/M26-1.5/M18TUBE	1	
BFH1C4432212	-12HS/M30-2.0/M22TUBE	1	
BFH1C4432816	-16HS/M36-2.0/M28TUBE	1	

## IC5 FEMALE METRIC SWIVEL LIGHT SERIES

90° ELBOW - SERIES #43 CRIMP FITTING

Line: 882-03

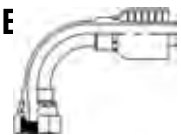

PART NUMBER	SIZE	QTY/BX	LIST PRICE
BFJ1C54384	-4HS/M14-1.5/M8 TUBE	2	
BFJ1C543105	-5HS/M16-1.5/M10TUBE	2	
BFJ1C543106	-6HS/M16-1.5/M10TUBE	2	
BFJ1C543126	-6HS/M18-1.5/M12TUBE	2	
BFJ1C543158	-8HS/M22-1.5/M15TUBE	2	
BFJ1C5431810	-10HS/M26-1.5/M18TUBE	1	
BFJ1C5432212	-12HS/M30-2.0/M22TUBE	1	
BFJ1C5432816	-16HS/M36-2.0/M28TUBE	1	

## ICA FEM METRIC SWIV O-RING L/SER STRA

Line: 882-04



PART NUMBER	SIZE	QTY/BX	LIST PRICE
BFK1CA43126	-6HS/M18-1.5/M12TUBE	2	
BFK1CA43158	-8HS/M22-1.5/M15TUBE	2	
BFK1CA432212	-12HS/M30-2.0/M22TUBE	1	
BFK1CA432816	-16HS/M30-2.0/M28TUBE	1	

**ICE FEM METRIC SWIV O-RING 45° ELB #43 CR**



Line: 882-05

PART NUMBER	SIZE	QTY/BX	LIST PRICE
BKE1CE43158	-8HS/M22-1.5/M15TUBE	1	
BKE1CE432212	-12HS/M30-2.0/M22TUBE	1	

**ICF FEM METRIC SWIV O-RING 90° ELB #43 CR**



Line: 882-06

PART NUMBER	SIZE	QTY/BX	LIST PRICE
BKF1CF43126	-6HS/M18-1.5/M12TUBE	1	
BKF1CF43158	-8HS/M22-1.5/M15TUBE	1	
BKF1CF432212	-12HS/M30-2.0/M22TUBE	1	

**1D2 MALE METRIC STUD HVY SER #43 CR**

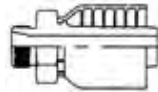

Line: 882-07

PART NUMBER	SIZE	QTY/BX	LIST PRICE
BFL1D24384	-4HS/M16-1.5/M8TUBE	2	
BFL1D243104	-4HSE/M18-1.5/M10TUBE	2	
BFL1D243125	-5HSE/M20-1.5/M12TUBE	2	
BFL1D243126	-6HS/M20-1.5/M12TUBE	2	
BFL1D243146	-6HS/M22-1.5/M14TUBE	2	
BFL1D243168	-8HS/M24-1.5/M16TUBE	2	
BFL1D2432010	-10HS/M30-2.0/M20TUBE	2	
BFL1D2432512	-12HS/M36-2.0/M25TUBE	2	
BFL1D2433016	-16HS/M42-2.0/M30TUBE	1	

**IC6 FEMALE METRIC STRA HVY SER #43 CR**

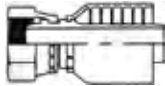

Line: 882-08

PART NUMBER	SIZE	QTY/BX	LIST PRICE
BFM1C643104	-4HS/M18-1.5/M10TUBE	4	
BFM1C64384	-4HS/M16-1.5/M8TUBE	4	
BFM1C643125	-5HS/M20-1.5/M12TUBE	2	
BFM1C643126	-6HS/M20-1.5/M12TUBE	2	
BFM1C643146	-6HS/M22-1.5/M14TUBE	2	
BFM1C643168	-8HS/M24-1.5/M16TUBE	2	
BFM1C6432010	-10HS/M30-2.0/M20TUBE	2	
BFM1C6432012	-12HS/M30-2.0/M20TUBE	2	
BFM1C6432512	-12HS/M36-2.0/M25TUBE	1	
BFM1C6433016	-16HS/M42-2.0/M30TUBE	1	

**ID9 MALE/BSP PARALLEL THRD STRA #43 CR**

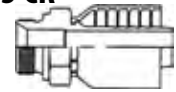

Line: 882-09

PART NUMBER	SIZE	QTY/BX	LIST PRICE
BFT1D94344	-4 H X 1/4-19	2	
BFT1D94365	-5 H X 3/8-19	2	
BFT1D94366	-6 H X 3/8-19	2	
BFT1D94388	-8 H X 1/2-14	2	
BFT1D9431212	-12 H X 3/4-14	1	
BFT1D9431616	-16 H X 1-11	1	

**I92 FEM/BSP SWVL BALL/NOSE STRA #43 CR**

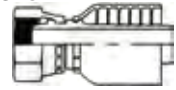

Line: 882-10

PART NUMBER	SIZE	QTY/BX	LIST PRICE
BFV1924344	-4 H X 1/4-19	2	
BFV1924365	-5 H X 3/8-19	2	
BFV1924366	-6 H X 3/8-19	2	
BFV1924388	-8 H X 1/2-14	2	
BFV192431010	-10 H X 5/8-14	1	
BFV192431212	-12 H X 3/4-14	2	
BFV192431616	-16 H X 1-11	1	

**IB1 FEM/BSP SWVL BALL/NOSE 45° ELB#**



Line: 882-11

PART NUMBER	SIZE	QTY/BX	LIST PRICE
BFW1B14344	-4 H X 1/4-19	5	
BFW1B14366	-6 H X 3/8-19	5	
BFW1B14388	-8 H X 1/2-14	4	
BFW1B1431010	-10 H X 5/8-14	2	
BFW1B1431210	-10 H X 3/4-14	2	
BFW1B1431212	-12 H X 3/4-14	2	
BFW1B1431616	-16 H X 1-11	2	

**IB2 FE/BSP SWVL BALL/NOSE 90° ELB#43**

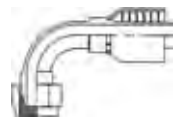

Line: 882-12

PART NUMBER	SIZE	QTY/BX	LIST PRICE
BFX1B24344	-4 H X 1/4-19	5	
BFX1B24366	-6 H X 3/8-19	5	
BFX1B44366	-6HX3/8 BLOCK STYLE	1	
BFX1B24388	-8 H X 1/2-14	4	
BFX1B2431010	-10 H X 5/8-14	2	
BFX1B2431210	-10 H X 3/4-14	2	
BFX1B2431212	-12 H X 3/4-12	2	
BFX1B2431616	-16 H X 1-11	2	
BFX1B2432020	-20 H X 1 1/4-11	1	



## IUT JIS/BSP TAPR PIPE RIGID MALE

43 SERIES CRIMP FITT

Line: 882-13

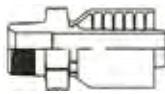

PART NUMBER	SIZE	QTY/BX	LIST PRICE
BFY1UT4344	-4 H X 1/4-19	5	
BFY1UT4364	-4 H X 3/8-19	1	
BFY1UT4366	-6 H X 3/8-19	5	
BFY1UT4368	-8 H X 3/8-19	1	
BFY1UT4388	-8 H X 1/2-14	5	
BFY1UT431212	-12 H X 3/4-14	4	
BFY1UT432020	-12 H X 1 1/4-11	1	
BFY1UT431616	-16 H X 1-11	1	

## IGU FE SWV BSP/JIS PARL 60° CONE STRA 43

43 SERIES CRIMP FITT

Line: 882-14



PART NUMBER	SIZE	QTY/BX	LIST PRICE
BFZ1GU4344	-4 H X 1/4-19	5	
BFZ1GU4366	-6 H X 3/8-19	5	
BFZ1GU4388	-8 H X 1/2-14	4	
BFZ1GU431212	-12 H X 3/4-14	2	
BFZ1GU431616	-16 H X 1-11	1	
BFZ1GU432020	-20 H X 1 1/4-11	1	

## IFU FE SWV JIS/BSP PARL 30° CONE STRA 43

43 SERIES CRIMP FITT

Line: 882-15



PART NUMBER	SIZE	QTY/BX	LIST PRICE
BGD1FU4344	-4 H X 1/4-19	5	
BGD1FU4366	-6 H X 3/8-19	5	
BGD1FU4388	-8 H X 1/2-14	5	
BGD1FU431212	-12 H X 3/4-14	2	
BGD1FU431616	-16 H X 1-11	1	
BGD1FU432020	-20 H X 1 1/4-11	1	

## IC9 O-RING FEM METRIC SWIVL HVY 71 SER

HI-PRESSURE CRIMP

Line: 882-30

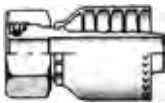

PART NUMBER	SIZE	QTY/BX	LIST PRICE
BRF1C971126	M20-1.5/M12TUBE/-6HS	2	
BRF1C971146	M22-1.5/M14TUBE/-6H	2	
BRF1C971168	M24-1.5/M16TUBE/-8H	2	
BRF1C9712010	M30-2/M20TUBE/-10H	1	
BRF1C9712512	M36-2/M25TUBE/-12H	1	
BRF1C9713016	M42-2/M30TUBE/-16H	1	

## IUT BSP/JIS TAPR RIGD STRA HVY 71 SER

HI-PRESSURE CRIMP FITT

Line: 882-33

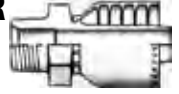

PART NUMBER	SIZE	QTY/BX	LIST PRICE
BRJ1UT7166	3/8-19 / -6HOSE	2	
BRJ1UT7188	1/2-14 / -8 HOSE	2	
BRJ1UT711212	3/4-14 / -12 HOSE	2	
BRJ1UT711616	1-11 / -16 HOSE	2	
BRJ1UT712020	1 1/4-11 / -20 HOSE	1	
BRJ1UT712424	1 1/2-11 / -24 HOSE	1	

## IMU FEM JIS METRIC SWIVEL 30° FLARE

71 SERIES HI-PRES CRIMP

Line: 882-34

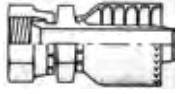

PART NUMBER	SIZE	QTY/BX	LIST PRICE
BRK1MU7166	M18-1.5 / -6 HOSE	2	
BRK1MU7188	M22-1.5 / -8 HOSE	2	
BRK1XU711010	M24-1.5/-10H JAP	1	
BRK1XU712424	M24-1.5/-24H JAP	1	
BRK1XU711212	M30-1.5/-12H JAP	1	
BRK1XU711616	M33-1.5/-16H JAP	1	
BRK1XU712020	M36-1.5/-20H JAP	1	

## 71 SERIES - PARKER #1GU71

METRIC FEMALE BSPP 60° STRAIGHT SWIVEL CRIMP

Line: 882-38

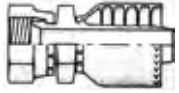

PART NUMBER	SIZE	QTY/BX	LIST PRICE
BRP1GU7166	3/8-19 BSPP X -6 H	2	
BRP1GU7188	1/2-14 BSPP X-8 H	2	
BRP1GU711212	3/4-14 BSPP X-12 H	2	
BRP1GU711616	1-11 BSPP X -16 H	2	
BRP1GU712020	1 1/4-11BSPP X-20H	1	
BRP1GU712424	1 1/2-11BSPP X-24H	1	
BRP1GU713232	2-11 BSPP X-32 H	1	

## IFU FEM BSPP 30° CONE SWVL STRA 71 SER

HI-PRESSURE CRIMP FITT

Line: 882-39

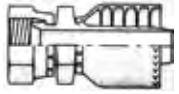

PART NUMBER	SIZE	QTY/BX	LIST PRICE
BRR1FU7166	3/8-19 / -6 H	2	
BRR1FU7188	1/2-14 / -8 H	2	
BRR1FU711212	3/4-14 / -12 H	2	
BRR1FU711616	1-11 / -16 H	2	
BRR1FU712020	1 1/4-11 / -20 H	1	
BRR1FU712424	1 1/2-11 / -24 H	1	

### MALE PIPE RIDGED STRA HOSE FT

78 SERIES VERY HI-PRES CRIMP

Line: 882-50

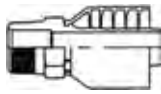

PART NUMBER	SIZE	QTY/BX	LIST PRICE
BXL101781212	3/4-14 MPT	1	
BXL101781616	1-11 1/2 MPT	1	
BXL101782020	1 1/4-11 1/2 MPT	1	
BXL101782424	1 1/2-11 1/2 MPT	1	
BXL101783232	2-11 1/2 MPT	1	

### FEMALE JIC SWIVEL STR #10678

78 SERIES VERY HI-PRES CRIMP

Line: 882-51



PART NUMBER	SIZE	QTY/BX	LIST PRICE
BXM106781212	3/4 (1 1/16-12)	1	
BXM106781612	1X 3/4 (1 5/16-12)	1	
BXM106781616	1 (1 5/16-12)	1	
BXM106782020	1 1/4 (1 5/8-12)	1	
BXM106782424	1 1/2 (1 7/8-12)	1	
BXM106783232	2 (2 1/2-12)	1	

### FEMALE JIC SWIVEL 90° ELB STR #13978

78 SERIES VERY HI-PRES CRIMP

Line: 882-52

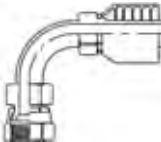

PART NUMBER	SIZE	QTY/BX	LIST PRICE
BXN139781212	3/4 (1 1/16)	1	
BXN139781616	1 (1 5/16-12)	1	

### #61 FLANGE STRAIGHT HOSE FITTING

78 SERIES VERY HI-PRES CRIMP

Line: 882-53



PART NUMBER	SIZE	QTY/BX	LIST PRICE
BXP115781212	3/4 -12H	1	
BXP115781616	1 (-16 H)	1	
BXP14A782020	1 1/4 (-20 H)	1	
BXP14A782424	1 1/2 (-24 H)	1	
BXP14A783224	2 (-24 H)	1	
BXP14A783232	2 (-32 H)	1	

### 78 #61 FLANGE 45° ELBOW HSE FIT #11778

Line: 882-54



PART NUMBER	SIZE	QTY/BX	LIST PRICE
BXR117781212	3/4 (-12 H)	1	
BXR117781616	1 (-16 H)	1	
BXR14F782020	1 1/4 (-20 H)	1	
BXR14F782424	1 1/2 (-24 H)	1	
BXR14F783232	2 (-32 H)	1	

### #61 90° FLANGE ELBOW HSE FIT #11978

78 SERIES VERY HI-PRES CRIMP

Line: 882-55



PART NUMBER	SIZE	QTY/BX	LIST PRICE
BXT119781212	3/4 (-12 H)	1	
BXT119781616	1 (-16 H)	1	
BXT14N782016	1 1/4 (-16 H)	1	
BXT14N782020	1 1/4 (-20 H)	1	
BXT14N782424	1 1/2 (-24 H)	1	
BXT14N783232	2 (-32 H)	1	

### #62 FLANGE STRAIGHT #16A78

78 SERIES VERY HI-PRES CRIMP

Line: 882-56

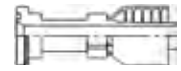

PART NUMBER	SIZE	QTY/BX	LIST PRICE
BXV16A781212	3/4 (-12 H)	1	
BXV16A781612	1 (-12 H)	1	
BXV16A781616	1 (-16 H)	1	
BXV16A782020	1 1/4 (-20 H)	1	
BXV16A782420	1 1/2 (-20 H)	1	
BXV16A782424	1 1/2 (-24 H)	1	
BXV16A782016	1 1/4 (-16 H)	1	
BXV16A783224	2 (-24 H)	1	
BXV16A783232	2 (-32 H)	1	

### 78 SERIES #62 FLANGE 22.5° ELB #16B78

VERY HI-PRES CRIMP

Line: 882-57

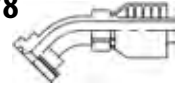

PART NUMBER	SIZE	QTY/BX	LIST PRICE
BXW16B781616	1 (-16 H)	1	

### 78 SERIES #62 45° FLANGE ELB #16F78

VERY HI-PRES CRIMP

Line: 882-58

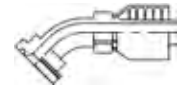

PART NUMBER	SIZE	QTY/BX	LIST PRICE
BXX16F781212	3/4 FLNG X -12 H	1	
BXX16F781612	1 FLNG X -12 H	1	
BXX16F781616	1 FLNG X -16 H	1	
BXX16F782016	1 1/4 FLNG X -16H	1	
BXX16F782020	1 1/4 FLNG X -20H	1	
BXX16F782424	1 1/2 FLNG X -24H	1	
BXX16F783232	2FLNG X -32 H	1	

### 78 SERIES #62 90° FLANGE ELB #16N78

VERY HI-PRES CRIMP

Line: 882-59



PART NUMBER	SIZE	QTY/BX	LIST PRICE
BXY16N781212	3/4 FLNG X -12 H	1	
BXY16N781612	1FLNG X -12H	1	
BXY16N781616	1FLANGE X -16H 7	1	
BXY16N782016	1 1/4FLNG X -16H	1	
BXY16N782020	1 1/4 FLNG X-20 H	1	
BXY16N782424	1 1/2 FLNG X -24H	1	
BXY16N783232	2FLNG X -32 H	1	

### 78 SEAL/LOCK LONG STRA SWIVEL 1JS78

VERY HI-PRES CRIMP

Line: 882-60



PART NUMBER	SIZE	QTY/BX	LIST PRICE
BXZ1JS781212	1 3/16S/L-12 X-12H	1	
BXZ1JS782016	1-11/16SL-20X -16H	1	
BXZ1JS782020	1-11/16SL-20X-20H	1	
BXZ1JS781616	1 7/16SL-16 X -16H	1	
BXZ1JS782424	2SL-24 X -24 H	1	

### SEAL/LOCK L45° FEM SWIVEL ELBOW #1J778

78 SERIES VERY HI-PRES CRIMP

Line: 882-61

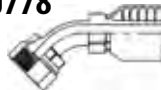

PART NUMBER	SIZE	QTY/BX	LIST PRICE
BYD1J7781212	1-3/16SL-12 X-12H	1	
BYD1J7781616	1-7/16SL-16 X -16H	1	
BYD1J7782020	1-11/16SL-20 X-20H	1	
BYD1J7782424	2SL-24 X -24 H	1	

### SEAL/LOCK L90° FEM ELBOW SWV #1J978

78 SERIES VERY HI-PRES CRIMP

Line: 882-62



PART NUMBER	SIZE	QTY/BX	LIST PRICE
BYE1J9781212	1-3/16SL-12 X -12H	1	
BYE1J9781616	1-7/16SL-16 X -16H	1	
BYE1J9782016	1-11/16SL-20 X-16H	1	
BYE1J9782020	1-11/16SL-20 X-20H	1	
BYE1J9782424	2SL-24 X -24 H	1	

### METRIC MALE STUD STRA HVY #1D278

78 SERIES VERY HI-PRES CRIMP

Line: 882-65

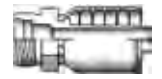

PART NUMBER	SIZE	QTY/BX	LIST PRICE
BYF1D2782512	M36-2.0 X -12 H	1	
BYF1D2783016	M42-2.0 X -16 H	1	
BYF1D2783820	M52-2.0 X -20 H	1	

### METRIC FEM SVL STR HVY #1C978

78 SERIES VERY HI-PRES CRIMP

Line: 882-66

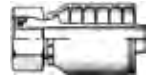

PART NUMBER	SIZE	QTY/BX	LIST PRICE
BYG1C9782512	M36-2.0 X -12 H	1	
BYG1C9783016	M42-2.0 X -16 H	1	
BYG1C9783820	M52-2.0 X -20 H	1	

### METRIC FEM SWVL 45° ELB HVY #10C78

78 SERIES VERY HI-PRES CRIMP

Line: 882-67



PART NUMBER	SIZE	QTY/BX	LIST PRICE
BYH10C782512	M36-2.0 X -12 H	1	
BYH10C783016	M42-2.0 X -16 H	1	
BYH10C783820	M52-2.0 X -20 H	1	

### METRIC FEM SWVL 90° ELB HVY #11C78

78 SERIES VERY HI-PRES CRIMP

Line: 882-68



PART NUMBER	SIZE	QTY/BX	LIST PRICE
BYJ11C782512	M36-2.0 X -12 H	1	
BYJ11C783016	M42-2.0 X -16 H	1	
BYJ11C783820	M52-2.0 X -20 H	1	

### 78 SERIES - PARKER 1GU78 - VERY HI PRES

METRIC BSP/JIS 60 P/P FEMALE SWIVEL CRIMP FITTING

Line: 882-69



PART NUMBER	SIZE	QTY/BX	LIST PRICE
BYK1GU781212	3/4-14 PAR/PIPE/-12H	1	
BYK1GU781616	1-11 PAR/PIPEX -16H	1	

**NOTE: NEED HYDRAULIC ASSEMBLIES?? TITAN PROVIDES HOSE/FITTING CRIMPED ASSEMBLIES IN OUR GEORGIA PLANT FOR 3/16 ID DIA THROUGH 2" DIAMETER. CALL MIKE OR RON FOR ASSISTANCE IN ORDERING.**

# SECTION 11 PRODUCT INDEX

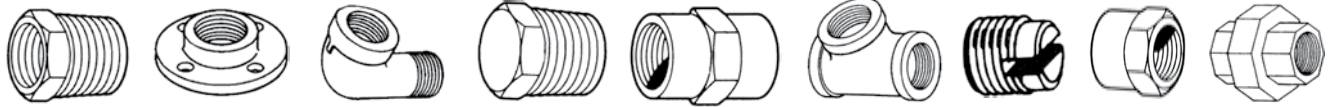

## CAST IRON, STEEL, AND MALLEABLE FITTINGS

Line Description	Alpha	Line#	Page#
PIPE NIPPLES - BLACK IRON - SCHEDULE 40	GHB	883-00	
EXTRA HEAVY LONG NIPPLES - BLACK IRON	GKB	883-01	
PIPE COUPLING - BLACK IRON (STEEL)	GVB	886-00	
1/2 PIPE COUPLING - BLACK IRON (STEEL)	GZB	888-00	
SQUARE PIPE PLUG PLAIN (STEEL)	HHB	889-00	
HEX PIPE PLUG PLAIN (STEEL)	HKB	890-00	
HEX PIPE LOCKNUT PLAIN (STEEL)	HMB	891-00	
SLOTTED PLUG PLAIN (STEEL)	HPB	892-00	
HEX CTSK PIPE PLUG PLAIN (STEEL)	HSB	893-00	
SQUARE CTSK PIPE PLUG PLAIN (STEEL)	HUB	894-00	
HEX PIPE CAP PLAIN (STEEL)	HWB	895-00	
HEX PIPE BUSHING PLAIN (STEEL)	HYB	896-00	
SQUARE CTSK CAST IRON PLUG (BLACK)	KHB	898-00	
SQUARE PIPE PLUG CAST IRON (BLACK)	KKB	899-00	
FLOOR FLANGE CAST IRON (BLACK)	KMB	900-00	
UNIONS 150# MALLEABLE (BLACK)	HBB	901-00	
UNIONS 300# MALLEABLE (BLACK)	HFB	904-00	
HEX PIPE BUSHINGS MALLEABLE (BLACK)	JCB	905-00	
90° REDUCING FEMALE ELBOW MALLEABLE (BLACK)	JEB	906-00	
90° REDUCING STREET ELBOW MALLEABLE (BLACK)	JGB	907-00	
REDUCER COUPLING MALLEABLE (BLACK)	JJB	908-00	
45° FEMALE ELBOW MALLEABLE (BLACK)	JNB	909-00	
90° FEMALE ELBOW MALLEABLE (BLACK)	JRB	910-00	
90° STREET ELBOW MALLEABLE (BLACK)	JTB	911-00	
45° STREET ELBOW MALLEABLE (BLACK)	JVB	912-00	
REDUCING TEE MALLEABLE (BLACK)	JXB	913-00	
FEMALE TEE MALLEABLE (BLACK)	JZB	914-00	
STREET TEE MALLEABLE (BLACK)	AAA	914-01	
FEMALE CROSS MALLEABLE (BLACK)	KBB	915-00	
PIPE LOCK NUT MALLEABLE (BLACK)	KDB	916-00	
PIPE CAP MALLEABLE (BLACK)	KFB	917-00	
EXTENTION ADAPTER MALLEABLE (BLACK)	AAL	917-01	

# SECTION 11 PRODUCT INDEX

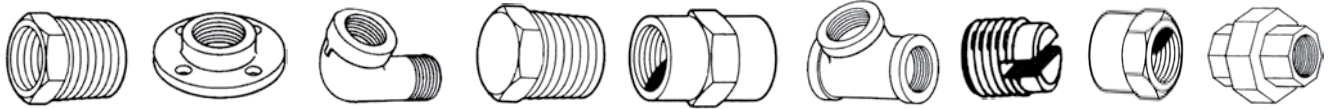

## GALVANIZED FITTINGS

Line Description	Alpha	Line#	Page#
PIPE NIPPLES - SCHEDULE 40 - GALVANIZED	<b>GJB</b>	<b>918-00</b>	
PIPE COUPLINGS - STEEL - GALVANIZED	<b>GWB</b>	<b>921-00</b>	
SQUARE PIPE PLUGS - STEEL & FORGED GALVANIZED	<b>HJB</b>	<b>923-00</b>	
HEX PIPE PLUGS - STEEL ZINC PLATED	<b>HLB</b>	<b>924-00</b>	
SLOTTED PIPE PLUGS - STEEL ZINC PLATED	<b>HRB</b>	<b>926-00</b>	
HEX CTSK PIPE PLUGS - STEEL ZINC PLATED	<b>HTB</b>	<b>927-00</b>	
SQUARE CTSK PIPE PLUGS - STEEL ZINC PLATED	<b>HVB</b>	<b>928-00</b>	
HEX PIPE CAP - STEEL ZINC PLATED	<b>HXB</b>	<b>929-00</b>	
HEX BUSHINGS - STEEL ZINC PLATED	<b>HZB</b>	<b>930-00</b>	
FACE BUSHINGS - STEEL ZINC PLATED	<b>JBB</b>	<b>931-00</b>	
SQUARE PLUG CTSK - CAST IRON GALVANIZED	<b>KJB</b>	<b>932-00</b>	
SQUARE PLUG - CAST IRON GALVANIZED	<b>KLB</b>	<b>933-00</b>	
FLOOR FLANGE - CAST IRON GALVANIZED	<b>KNB</b>	<b>934-00</b>	
UNION 150# - MALLEABLE IRON - GALVANIZED	<b>HCB</b>	<b>935-00</b>	
UNION 300# - MALLEABLE IRON - GALVANIZED	<b>HGB</b>	<b>937-00</b>	
HEX PIPE BUSHINGS - MALLEABLE IRON - GALVANIZED	<b>JDB</b>	<b>938-00</b>	
90° FEMALE REDUCING ELBOW - MALLEABLE IRON - GALVANIZED	<b>JFB</b>	<b>939-00</b>	
REDUCER COUPLINGS - MALLEABLE IRON - GALVANIZED	<b>JKB</b>	<b>941-00</b>	
45° FEMALE PIPE ELBOW - MALLEABLE - GALVANIZED	<b>JPB</b>	<b>942-00</b>	
90° FEMALE PIPE ELBOW - MALLEABLE - GALVANIZED	<b>JSB</b>	<b>943-00</b>	
90° PIPE STREET ELBOW - MALLEABLE - GALVANIZED	<b>JUB</b>	<b>944-00</b>	
45° PIPE STREET ELBOW - MALLEABLE - GALVANIZED	<b>JWB</b>	<b>945-00</b>	
FEMALE PIPE TEE - MALLEABLE - GALVANIZED	<b>KAB</b>	<b>947-00</b>	
FEMALE PIPE CROSS - MALLEABLE - GALVANIZED	<b>KCB</b>	<b>948-00</b>	
PIPE CAP - MALLEABLE - GALVANIZED	<b>KGB</b>	<b>950-00</b>	

## STAINLESS STEEL FITTINGS

Line Description	Alpha	Line#	Page#
PIPE NIPPLES - 304 STAINLESS	<b>GSB</b>	<b>951-00</b>	
90° FEMALE PIPE ELBOW - 304 STAINLESS	<b>LBB</b>	<b>952-00</b>	
FEMALE PIPE TEE - 304 STAINLESS	<b>LCB</b>	<b>953-00</b>	
45° FEMALE PIPE ELBOW - 304 STAINLESS	<b>LEB</b>	<b>955-00</b>	
90° STREET PIPE ELBOW - 304 STAINLESS	<b>LGB</b>	<b>957-00</b>	
FEMALE COUPLING - 304 STAINLESS	<b>LHB</b>	<b>958-00</b>	
PIPE CAPS - 304 STAINLESS	<b>LKB</b>	<b>960-00</b>	
SQUARE PIPE PLUGS - 304 STAINLESS	<b>LLB</b>	<b>961-00</b>	
HEX PIPE PLUGS - 304 STAINLESS	<b>LMB</b>	<b>962-00</b>	
PIPE SCREW UNIONS - 304 STAINLESS	<b>LNB</b>	<b>963-00</b>	
REDUCER COUPLING - 304 STAINLESS	<b>MJB</b>	<b>966-00</b>	
HEX PIPE BUSHINGS - 304 STAINLESS	<b>MKB</b>	<b>967-00</b>	

# SECTION 11 PRODUCT INDEX

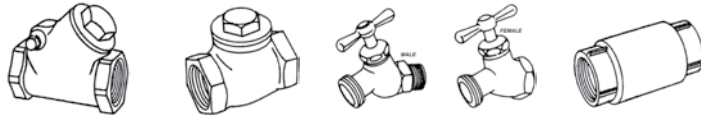

## VALVES

Line Description	Alpha	Line#	Page#
BRONZE GATE VALVES 150#	KPB	991-00	
BRONZE FEMALE PIPE CHECK VALVE	AXP	992-01	
BRASS SWING FEMALE PIPE CHECK VALVE 150#	BHX	992-02	
BRASS SWING Y FEMALE PIPE CHECK VALVE 150#	BHY	992-03	
90° HOSE BIBS W 3/4 GARDEN HOSE THD - BRASS	BHZ	992-04	
NO KINK HOSE BIB W 3/4" GARDEN HOSE THD - BRASS	BJD	992-05	
SUPER EZ IRRIGATION TUBING .500ID	BLZ	992-91	



**CALL - 1 (800) 723-2826**

**SCHEDULE 40 - STD. LONG NIPPLE**

BLACK IRON PIPE FITTING

Line: 883-00

**SCHEDULE 40 - STD. LONG NIPPLE (cont.)**

BLACK IRON PIPE FITTING

Line: 883-00



PART NO.	SIZE	QTY/BX	LIST PRICE
GHB02	1/8 CLOSE	10	
GHB02032X	1/8 X 1	5	
GHB02048	1/8 X 1 1/2	5	
GHB02064	1/8 X 2	5	
GHB02080	1/8 X 2 1/2	5	
GHB02096	1/8 X 3	5	
GHB02112	1/8 X 3 1/2	5	
GHB02128	1/8 X 4	5	
GHB02144	1/8 X 4 1/2	5	
GHB02160	1/8 X 5	5	
GHB02176	1/8 X 5 1/2	5	
GHB02192	1/8 X 6	5	
GHB02224	1/8 X 7	1	
GHB02256X	1/8 X 8	1	
GHB02320X	1/8 X 10	1	
GHB02384	1/8 X 12	1	
GHB04	1/4 CLOSE	10	
GHB04048	1/4 X 1 1/2	5	
GHB04064	1/4 X 2	5	
GHB04080	1/4 X 2 1/2	5	
GHB04096	1/4 X 3	5	
GHB04112	1/4 X 3 1/2	5	
GHB04128	1/4 X 4	5	
GHB04144	1/4 X 4 1/2	5	
GHB04160	1/4 X 5	5	
GHB04176	1/4 X 5 1/2	5	
GHB04192	1/4 X 6	5	
GHB04208X	1/4 X 6 1/2	1	
GHB04224	1/4 X 7	1	
GHB04256	1/4 X 8	1	
GHB04288	1/4 X 9	1	
GHB04320X	1/4 X 10	1	
GHB04352	1/4 X 11	1	
GHB04384	1/4 X 12	1	
GHB06	3/8 CLOSE	10	
GHB06048	3/8 X 1 1/2	5	
GHB06064	3/8 X 2	5	
GHB06080	3/8 X 2 1/2	5	
GHB06096	3/8 X 3	5	
GHB06112	3/8 X 3 1/2	5	
GHB06128	3/8 X 4	5	
GHB06144	3/8 X 4 1/2	5	
GHB06160	3/8 X 5	5	
GHB06176	3/8 X 5 1/2	5	

(continued...)

PART NO.	SIZE	QTY/BX	LIST PRICE
GHB06192	3/8 X 6	5	
GHB06224X	3/8 X 7	1	
GHB06256	3/8 X 8	1	
GHB06320	3/8 X 10	1	
GHB06384X	3/8 X 12	1	
GHB08	1/2 CLOSE	10	
GHB08048	1/2 X 1 1/2	5	
GHB08064	1/2 X 2	5	
GHB08080	1/2 X 2 1/2	5	
GHB08096	1/2 X 3	5	
GHB08112	1/2 X 3 1/2	5	
GHB08128	1/2 X 4	5	
GHB08144	1/2 X 4 1/2	5	
GHB08160	1/2 X 5	5	
GHB08176	1/2 X 5 1/2	5	
GHB08192	1/2 X 6	5	
GHB08208X	1/2 X 6 1/2	1	
GHB08224	1/2 X 7	1	
GHB08256	1/2 X 8	1	
GHB08320	1/2 X 10	1	
GHB08384	1/2 X 12	1	
GHB12	3/4 CLOSE	5	
GHB12048	3/4 X 1 1/2	5	
GHB12064	3/4 X 2	5	
GHB12080	3/4 X 2 1/2	5	
GHB12096	3/4 X 3	5	
GHB12112	3/4 X 3 1/2	5	
GHB12128	3/4 X 4	5	
GHB12144	3/4 X 4 1/2	5	
GHB12160	3/4 X 5	5	
GHB12176	3/4 X 5 1/2	5	
GHB12192	3/4 X 6	5	
GHB12224	3/4 X 7	1	
GHB12256	3/4 X 8	1	
GHB12320	3/4 X 10	1	
GHB12384	3/4 X 12	1	
GHB16	1 CLOSE	5	
GHB16064	1 X 2	5	
GHB16080	1 X 2 1/2	5	
GHB16096	1 X 3	5	
GHB16112	1 X 3 1/2	5	
GHB16128	1 X 4	5	
GHB16144	1 X 4 1/2	5	
GHB16160	1 X 5	5	

(continued...)

**SCHEDULE 40 - STD. LONG NIPPLE (cont.)**

BLACK IRON PIPE FITTING

Line: 883-00



PART NO.	SIZE	QTY/BX	LIST PRICE
GHB16176	1 X 5 1/2	5	
GHB16192	1 X 6	5	
GHB16224	1 X 7	1	
GHB16256	1 X 8	1	
GHB16320	1 X 10	1	
GHB16384	1 X 12	1	
GHB20	1 1/4 CLOSE	1	
GHB20064	1 1/4 X 2	1	
GHB20080	1 1/4 X 2 1/2	1	
GHB20096	1 1/4 X 3	1	
GHB20112	1 1/4 X 3 1/2	1	
GHB20128	1 1/4 X 4	1	
GHB20144	1 1/4 X 4 1/2	1	
GHB20160	1 1/4 X 5	1	
GHB20176	1 1/4 X 5 1/2	1	
GHB20192	1 1/4 X 6	1	
GHB20224	1 1/4 X 7	1	
GHB20256	1 1/4 X 8	1	
GHB20320	1 1/4 X 10	1	
GHB20384X	1 1/4 X 12	1	
GHB24	1 1/2 CLOSE	1	
GHB24064	1 1/2 X 2	1	
GHB24080	1 1/2 X 2 1/2	1	
GHB24096	1 1/2 X 3	1	
GHB24112	1 1/2 X 3 1/2	1	
GHB24128	1 1/2 X 4	1	
GHB24144	1 1/2 X 4 1/2	1	
GHB24160	1 1/2 X 5	1	
GHB24176	1 1/2 X 5 1/2	1	
GHB24192	1 1/2 X 6	1	
GHB24384X	1 1/2 X 12	1	
GHB32	2 CLOSE	1	
GHB32080	2 X 2 1/2	1	
GHB32096	2 X 3	1	
GHB32112	2 X 3 1/2	1	
GHB32128	2 X 4	1	
GHB32144	2 X 4 1/2	1	
GHB32160	2 X 5	1	
GHB32176	2 X 5 1/2	1	
GHB32192	2 X 6	1	
GHB32320	2 X 10	1	
GHB32384	2 X 12	1	
GHB40	2 1/2 CLOSE	1	
GHB40128X	2 1/2 X 4	1	

(continued...)

**SCHEDULE 40 - STD. LONG NIPPLE (cont.)**

BLACK IRON PIPE FITTING

Line: 883-00



PART NO.	SIZE	QTY/BX	LIST PRICE
GHB40192X	2 1/2 X 6	1	
GHB48	3 CLOSE	1	
GHB48256	3 X 8	1	
GHB48384	3 X 12	1	
GHB64	4 CLOSE	1	
GHB64192	4 X 6	1	
GHB64384	4 X 12	1	

**SCHEDULE 40 - EXTRA HVY LONG NIPPLE**

BLACK IRON PIPE FITTING

Line: 883-01



PART NO.	SIZE	QTY/BX	LIST PRICE
GKB02	1/8 CLOSE	5	
GKB02032	1/8 X 1	5	
GKB02048	1/8 X 1 1/2	5	
GKB02064	1/8 X 2	5	
GKB02080	1/8 X 2 1/2	5	
GKB02096	1/8 X 3	5	
GKB02112	1/8 X 3 1/2	5	
GKB02128	1/8 X 4	5	
GKB02144	1/8 X 4 1/2	5	
GKB02160	1/8 X 5	5	
GKB02176	1/8 X 5 1/2	5	
GKB02192	1/8 X 6	5	
GKB04	1/4 CLOSE	5	
GKB04048	1/4 X 1 1/2	5	
GKB04064	1/4 X 2	5	
GKB04080	1/4 X 2 1/2	5	
GKB04096	1/4 X 3	5	
GKB04112	1/4 X 3 1/2	5	
GKB04128	1/4 X 4	5	
GKB04144	1/4 X 4 1/2	5	
GKB04160	1/4 X 5	5	
GKB04176	1/4 X 5 1/2	5	
GKB04192	1/4 X 6	5	
GKB04256	1/4 X 8	1	
GKB06	3/8 CLOSE	5	
GKB06048	3/8 X 1 1/2	5	
GKB06064	3/8 X 2	5	
GKB06080	3/8 X 2 1/2	5	
GKB06096	3/8 X 3	5	
GKB06112	3/8 X 3 1/2	5	
GKB06128	3/8 X 4	5	
GKB06144	3/8 X 4 1/2	5	
GKB06160	3/8 X 5	5	

(continued...)



**SCHEDULE 40 - EXTRA HVY LONG NIPPLE (cont.)**

BLACK IRON PIPE FITTING

Line: 883-01



PART NO.	SIZE	QTY/BX	LIST PRICE
GKB06176	3/8 X 5 1/2	5	
GKB06192	3/8 X 6	5	
GKB06256	3/8 X 8	1	
GKB08	1/2 CLOSE	10	
GKB08048	1/2 X 1 1/2	5	
GKB08064	1/2 X 2	5	
GKB08080	1/2 X 2 1/2	5	
GKB08096	1/2 X 3	5	
GKB08112	1/2 X 3 1/2	5	
GKB08128	1/2 X 4	5	
GKB08144	1/2 X 4 1/2	5	
GKB08160	1/2 X 5	5	
GKB08176	1/2 X 5 1/2	5	
GKB08192	1/2 X 6	5	
GKB08256	1/2 X 8	1	
GKB12	3/4 CLOSE	5	
GKB12048	3/4 X 1 1/2	5	
GKB12064	3/4 X 2	5	
GKB12080	3/4 X 2 1/2	5	
GKB12096	3/4 X 3	5	
GKB12112	3/4 X 3 1/2	5	
GKB12128	3/4 X 4	5	
GKB12144	3/4 X 4 1/2	5	
GKB12160	3/4 X 5	5	
GKB12176	3/4 X 5 1/2	5	
GKB12192	3/4 X 6	5	
GKB12224	3/4 X 7	1	
GKB12256	3/4 X 8	1	
GKB16	1 CLOSE	5	
GKB16064	1 X 2	5	
GKB16080	1 X 2 1/2	5	
GKB16096	1 X 3	5	
GKB16112	1 X 3 1/2	5	
GKB16128	1 X 4	5	
GKB16144	1 X 4 1/2	5	
GKB16160	1 X 5	5	
GKB16176	1 X 5 1/2	5	
GKB16192	1 X 6	5	
GKB16224	1 X 7	1	
GKB16256	1 X 8	1	
GKB16320	1 X 10	1	
GKB16352	1 X 11	1	
GKB20	1 1/4 CLOSE	1	
GKB20064	1 1/4 X 2	1	

(continued...)

**SCHEDULE 40 - EXTRA HVY LONG NIPPLE (cont.)**

BLACK IRON PIPE FITTING

Line: 883-01



PART NO.	SIZE	QTY/BX	LIST PRICE
GKB20080	1 1/4 X 2 1/2	1	
GKB20096	1 1/4 X 3	1	
GKB20112	1 1/4 X 3 1/2	1	
GKB20128	1 1/4 X 4	1	
GKB20144	1 1/4 X 4 1/2	1	
GKB20160	1 1/4 X 5	1	
GKB20176	1 1/4 X 5 1/2	1	
GKB20192	1 1/4 X 6	1	
GKB20224	1 1/4 X 7	1	
GKB20256	1 1/4 X 8	1	
GKB20320	1 1/4 X 10	1	
GKB20384	1 1/4 X 12	1	
GKB24	1 1/2 CLOSE	1	
GKB24064	1 1/2 X 2	1	
GKB24080	1 1/2 X 2 1/2	1	
GKB24096	1 1/2 X 3	1	
GKB24112	1 1/2 X 3 1/2	1	
GKB24128	1 1/2 X 4	1	
GKB24144	1 1/2 X 4 1/2	1	
GKB24160	1 1/2 X 5	1	
GKB24176	1 1/2 X 5 1/2	1	
GKB24192	1 1/2 X 6	1	
GKB24224	1 1/2 X 7	1	
GKB24256	1 1/2 X 8	1	
GKB24320	1 1/2 X 10	1	
GKB24384	1 1/2 X 12	1	
GKB32	2 CLOSE	1	
GKB32080	2 X 2 1/2	1	
GKB32096	2 X 3	1	
GKB32112	2 X 3 1/2	1	
GKB32128	2 X 4	1	
GKB32144	2 X 4 1/2	1	
GKB32160	2 X 5	1	
GKB32176	2 X 5 1/2	1	
GKB32192	2 X 6	1	
GKB32224	2 X 7	1	
GKB32256	2 X 8	1	
GKB32320	2 X 10	1	
GKB40320	2 1/2 X 10	1	
GKB40	2 1/2 X CLOSE	1	
GKB40096	2 1/2 X 3	1	
GKB40112	2 1/2 X 3 1/2	1	
GKB40128	2 1/2 X 4	1	
GKB40144	2 1/2 X 4 1/2	1	

(continued...)

**SCHEDULE 40 - EXTRA HVY LONG NIPPLE (cont.)**

BLACK IRON PIPE FITTING

Line: 883-01



PART NO.	SIZE	QTY/BX	LIST PRICE
GKB40160	2 1/2 X 5	1	
GKB40176	2 1/2 X 5 1/2	1	
GKB40192	2 1/2 X 6	1	
GKB40224	2 1/2 X 7	1	
GKB40256	2 1/2 X 8	1	
GKB40384	2 1/2 X 12	1	

**SCHEDULE 40 - PIPE COUPLING**

BLACK IRON PIPE FITTING

Line: 886-00

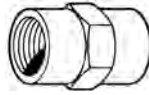

PART NO.	SIZE	QTY/BX	LIST PRICE
GVB02	1/8	5	
GVB04	1/4	5	
GVB06	3/8	5	
GVB08	1/2	5	
GVB12	3/4	5	
GVB16	1	5	
GVB20	1 1/4	1	
GVB24	1 1/2	1	
GVB32	2	1	
GVB40	2 1/2	1	
GVB48	3	1	
GVB64	4	1	

**SCHEDULE 40 - STANDARD 1/2 COUPLING**

BLACK IRON PIPE FITTING

Line: 888-00



PART NO.	SIZE	QTY/BX	LIST PRICE
GZB02	1/8	5	
GZB04	1/4	5	
GZB06	3/8	5	
GZB08	1/2	5	
GZB12	3/4	5	
GZB16	1	5	
GZB20	1 1/4	1	

**SQUARE PIPE PLUG**

BLACK STEEL PIPE FITTING

Line: 889-00



PART NO.	SIZE	QTY/BX	LIST PRICE
HHB02	1/8	10	
HHB04	1/4	10	
HHB06	3/8	10	
HHB08	1/2	10	
HHB12	3/4	5	
HHB16	1	5	
HHB20	1 1/4	5	

**HEX PIPE PLUG**

BLACK IRON PIPE FITTING

Line: 890-00

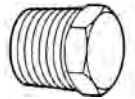

PART NO.	SIZE	QTY/BX	LIST PRICE
HKB02	1/8	10	
HKB04	1/4	10	
HKB06	3/8	10	
HKB08	1/2	10	
HKB12	3/4	5	
HKB16	1	5	
HKB20	1 1/4	5	
HKB24X	1 1/2	1	

**SLOTTED PIPE PLUG**

BLACK IRON PIPE FITTING

Line: 892-00



PART NO.	SIZE	QTY/BX	LIST PRICE
HPB02	1/8	10	
HPB04	1/4	10	
HPB06	3/8	10	
HPB08X	1/2	10	

**HEX COUNTERSUNK PIPE PLUG**

BLACK IRON PIPE FITTING

Line: 893-00

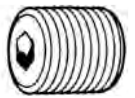

PART NO.	SIZE	QTY/BX	LIST PRICE
HSB02	1/8	10	
HSB04	1/4	10	
HSB06	3/8	10	
HSB08	1/2	10	
HSB12	3/4	5	
HSB16	1	5	
HSB20X	1 1/4	1	
HSB24	1 1/2	1	

## SQUARE COUNTERSUNK PIPE PLUG

BLACK IRON PIPE FITTING

Line: 894-00



PART NO.	SIZE	QTY/BX	LIST PRICE
HUB02	1/8	10	
HUB04	1/4	10	
HUB06	3/8	10	
HUB08	1/2	10	
HUB12	3/4	5	
HUB16	1	5	
HUB20X	1 1/4	1	
HUB32X	2	1	
HUB40	2 1/2	1	
HUB48	3	1	
HUB56X	3 1/2	1	

## SQUARE COUNTERSUNK PIPE PLUG

BLACK CAST IRON PIPE FITTING

Line: 898-00



PART NO.	SIZE	QTY/BX	LIST PRICE
KHB12	3/4	5	
KHB16	1	5	
KHB20	1 1/4	1	
KHB24	1 1/2	1	
KHB32	2	1	

## HEX PIPE CAP

BLACK IRON PIPE FITTING

Line: 895-00



PART NO.	SIZE	QTY/BX	LIST PRICE
HWB02	1/8	10	
HWB04	1/4	10	
HWB06	3/8	10	
HWB08	1/2	5	
HWB12	3/4	5	

## SQUARE PIPE PLUG

BLACK CAST IRON PIPE FITTING

Line: 899-00

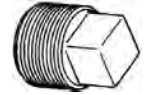

PART NO.	SIZE	QTY/BX	LIST PRICE
KKB08	1/2	5	
KKB12	3/4	5	
KKB16	1	5	
KKB20	1 1/4	1	
KKB24	1 1/2	1	
KKB32	2	1	
KKB40X	2 1/2	1	
KKB48X	3	1	

## HEX PIPE BUSHING

BLACK IRON PIPE FITTING

Line: 896-00



PART NO.	SIZE	QTY/BX	LIST PRICE
HYB0402	1/4 X 1/8	10	
HYB0602	3/8 X 1/8	10	
HYB0604	3/8 X 1/4	10	
HYB0802	1/2 X 1/8	10	
HYB0804	1/2 X 1/4	10	
HYB0806	1/2 X 3/8	10	
HYB1202	3/4 X 1/8	5	
HYB1204	3/4 X 1/4	5	
HYB1206	3/4 X 3/8	5	
HYB1208	3/4 X 1/2	5	
HYB1602	1 X 1/8	5	
HYB1604	1 X 1/4	5	
HYB1606	1 X 3/8	5	
HYB1608	1 X 1/2	5	
HYB1612	1 X 3/4	5	

## FLOOR FLANGE

BLACK IRON PIPE FITTING

Line: 900-00



PART NO.	SIZE	QTY/BX	LIST PRICE
KMB04	1/4	5	
KMB06	3/8	5	
KMB08	1/2	5	
KMB12	3/4	5	
KMB16	1	5	
KMB20X	1 1/4	1	
KMB24	1 1/2	1	
KMB32	2	1	



CALL - 1 (800) 723-2826

## 150 LB. UNION

BLACK MALLEABLE PIPE FITTING

Line: 901-00



PART NO.	SIZE	QTY/BX	LIST PRICE
HBB02	1/8	5	
HBB04	1/4	5	
HBB06	3/8	5	
HBB08	1/2	5	
HBB12	3/4	5	
HBB16	1	5	
HBB20	1 1/4	1	
HBB24	1 1/2	1	
HBB32	2	1	
HBB40	2 1/2	1	
HBB48	3	1	
HBB64	4	1	

## 250 LB. UNION

BLACK MALLEABLE PIPE FITTING

Line: 902-00



PART NO.	SIZE	QTY/BX	LIST PRICE
HDB02	1/8	5	
HDB04	1/4	5	
HDB06	3/8	5	
HDB08	1/2	5	
HDB12	3/4	5	
HDB16	1	5	
HDB20	1 1/4	1	
HDB24	1 1/2	1	
HDB32	2	1	
HDB40	2 1/2	1	
HDB48	3	1	
HDB64	4	1	

## 300 LB. UNION

BLACK MALLEABLE PIPE FITTING

Line: 904-00

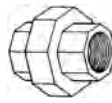

PART NO.	SIZE	QTY/BX	LIST PRICE
HFB02	1/8	5	
HFB04	1/4	5	
HFB06	3/8	5	
HFB08	1/2	5	
HFB12	3/4	5	
HFB16	1	5	
HFB20	1 1/4	1	
HFB24	1 1/2	1	
HFB32	2	1	
HFB40	2 1/2	1	

## HEX PIPE BUSHING

BLACK MALLEABLE PIPE FITTING

Line: 905-00

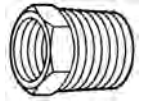

PART NO.	SIZE	QTY/BX	LIST PRICE
JCB1602	1 X 1/8	5	
JCB1604	1 X 1/4	5	
JCB1606	1 X 3/8	5	
JCB1608	1 X 1/2	5	
JCB1612	1 X 3/4	5	
JCB2004	1 1/4 X 1/4	1	
JCB2006	1 1/4 X 3/8	1	
JCB2008	1 1/4 X 1/2	1	
JCB2012	1 1/4 X 3/4	1	
JCB2016	1 1/4 X 1	1	
JCB2404	1 1/2 X 1/4	1	
JCB2406	1 1/2 X 3/8	1	
JCB2408	1 1/2 X 1/2	1	
JCB2412	1 1/2 X 3/4	1	
JCB2416	1 1/2 X 1	1	
JCB2420	1 1/2 X 1 1/4	1	
JCB3204X	2 X 1/4	1	
JCB3208	2 X 1/2	1	
JCB3212	2 X 3/4	1	
JCB3216	2 X 1	1	
JCB3220	2 X 1 1/4	1	
JCB3224	2 X 1 1/2	1	
JCB40024X	2 1/2 X 1 1/2	1	
JCB4020	2 1/2 X 1 1/4	1	
JCB4032	2 1/2 X 2	1	
JCB4832X	3 X 2	1	
JCB6432X	4 X 2	1	
JCB6448	4 X 3	1	

## 90° REDUCING ELBOW

BLACK MALLEABLE PIPE FITTING

Line: 906-00



PART NO.	SIZE	QTY/BX	LIST PRICE
JEB1608	1 X 1/2	5	
JEB1612	1 X 3/4	5	
JEB0402	1/4 X 1/8	5	
JEB0604	3/8 X 1/4	5	
JEB0804	1/2 X 1/4	5	
JEB0806	1/2 X 3/8	5	
JEB1206X	3/4 X 3/8	5	
JEB1208	3/4 X 1/2	5	

## 90° STREET ELBOW (REDUCING)

BLACK MALLEABLE PIPE FITTING

Line: 907-00



PART NO.	SIZE	QTY/BX	LIST PRICE
JGB0806	1/2 X 3/8	5	
JGB1208	3/4 X 1/2	5	

## REDUCER

BLACK MALLEABLE PIPE FITTING

Line: 908-00



PART NO.	SIZE	QTY/BX	LIST PRICE
JJB0402	1/4 X 1/8	5	
JJB0602	3/8 X 1/8	5	
JJB0604	3/8 X 1/4	5	
JJB0802X	1/2 X 1/8	5	
JJB0804	1/2 X 1/4	5	
JJB0806	1/2 X 3/8	5	
JJB1202X	3/4 X 1/8	5	
JJB1204	3/4 X 1/4	5	
JJB1206	3/4 X 3/8	5	
JJB1208	3/4 X 1/2	5	
JJB1604X	1 X 1/4	5	
JJB1606	1 X 3/8	5	
JJB1608	1 X 1/2	5	
JJB1612	1 X 3/4	5	
JJB2008	1 1/4 X 1/2	1	
JJB2012	1 1/4 X 3/4	1	
JJB2016	1 1/4 X 1	1	
JJB2408X	1 1/2 X 1/2	1	
JJB2412	1 1/2 X 3/4	1	
JJB2416	1 1/2 X 1	1	
JJB2420	1 1/2 X 1 1/4	1	
JJB3208X	2 X 1/2	1	
JJB3212X	2 X 3/4	1	
JJB3216	2 X 1	1	
JJB3220	2 X 1 1/4	1	
JJB3224	2 X 1 1/2	1	
JJB4016	2 1/2 X 1	1	
JJB4832	3 X 2	1	
JJB4840	3 X 2 1/2	1	
JJB6448	4 X 3	1	

## 45° FEMALE PIPE ELBOW

BLACK MALLEABLE PIPE FITTING

Line: 909-00



PART NO.	SIZE	QTY/BX	LIST PRICE
JNB02	1/8	5	
JNB04	1/4	5	
JNB06	3/8	5	
JNB08	1/2	5	
JNB12	3/4	5	
JNB16	1	5	
JNB20	1 1/4	1	
JNB24	1 1/2	1	
JNB32	2	1	
JNB48	3	1	

## 90° FEMALE PIPE ELBOW

BLACK MALLEABLE PIPE FITTING

Line: 910-00



PART NO.	SIZE	QTY/BX	LIST PRICE
JRB02	1/8	5	
JRB04	1/4	5	
JRB06	3/8	5	
JRB08	1/2	5	
JRB12	3/4	5	
JRB16	1	5	
JRB20	1 1/4	1	
JRB24	1 1/2	1	
JRB32	2	1	
JRB40	2 1/2	1	
JRB48	3	1	
JRB64	4	1	

## 90° STREET ELBOW

BLACK MALLEABLE PIPE FITTING

Line: 911-00



PART NO.	SIZE	QTY/BX	LIST PRICE
JTB02	1/8	5	
JTB04	1/4	5	
JTB06	3/8	5	
JTB08	1/2	5	
JTB12	3/4	5	
JTB16	1	5	
JTB20	1 1/4	1	
JTB24	1 1/2	1	
JTB32	2	1	
JTB40X	2 1/2	1	

## 45° STREET ELBOW

BLACK MALLEABLE PIPE FITTING

Line: 912-00



PART NO.	SIZE	QTY/BX	LIST PRICE
JVB02	1/8	5	
JVB04	1/4	5	
JVB06	3/8	5	
JVB08	1/2	5	
JVB12	3/4	5	
JVB16	1	5	
JVB20	1 1/4	1	
JVB24	1 1/2	1	
JVB32	2	1	

## REDUCING TEE

BLACK MALLEABLE PIPE FITTING

Line: 913-00



PART NO.	SIZE	QTY/BX	LIST PRICE
JXB040402	1/4 X 1/4 X 1/8	5	
JXB060604	3/8 X 3/8 X 1/4	5	
JXB080806	1/2 X 1/2 X 3/8	5	
JXB120808	3/4 X 1/2 X 1/2	5	
JXB121208	3/4 X 3/4 X 1/2	5	
JXB161612	1 X 1 X 3/4	1	
JXB161620X	1 X 1 X 1 1/4	1	
JXB202012	1 1/4 X 1 1/4 X 3/4	1	
JXB202016	1 1/4 X 1 1/4 X 1	1	
JXB240824X	1 1/2 X 1/2 X 1 1/2	1	
JXB241624X	1 1/2 X 1 X 1 1/2	1	
JXB242416	1 1/2 X 1 1/2 X 1	1	
JXB242420	1 1/2 X 1 1/2 X 1 1/4	1	
JXB323212X	2 X 2 X 3/4	1	
JXB323216	2 X 2 X 1	1	
JXB323220	2 X 2 X 1 1/4	1	

## BLACK MALLEABLE TEE

Line: 914-00



PART NO.	SIZE	QTY/BX	LIST PRICE
JZB02	1/8	5	
JZB04	1/4	5	
JZB06	3/8	5	
JZB08	1/2	5	
JZB12	3/4	5	
JZB16	1	5	
JZB20	1 1/4	1	
JZB24	1 1/2	1	
JZB32	2	1	
JZB40	2 1/2	1	
JZB48	3	1	

## STREET TEE

BLACK MALLEABLE PIPE FITTING

Line: 914-01

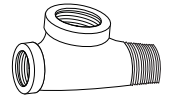

PART NO.	SIZE	QTY/BX	LIST PRICE
AAA04	1/4 STR.TEE BLK IRON	5	
AAA06	3/8 BI ST TEE	5	

## CROSS

BLACK MALLEABLE PIPE FITTING

Line: 915-00



PART NO.	SIZE	QTY/BX	LIST PRICE
KBB02X	1/8	5	
KBB04X	1/4	5	
KBB06	3/8	5	
KBB08	1/2	5	
KBB12	3/4	5	
KBB16	1	5	
KBB20	1 1/4	1	
KBB24	1 1/2	1	
KBB32	2	1	

## LOCK NUT

BLACK MALLEABLE PIPE FITTING

Line: 916-00



PART NO.	SIZE	QTY/BX	LIST PRICE
KDB02	1/8	5	
KDB04	1/4	5	
KDB06	3/8	5	
KDB08	1/2	5	
KDB12	3/4	5	
KDB16	1	5	
KDB20	1 1/4	1	
KDB24	1 1/2	1	

## PIPE CAP

BLACK MALLEABLE PIPE FITTING

Line: 917-00



PART NO.	SIZE	QTY/BX	LIST PRICE
KFB08	1/2	5	
KFB12	3/4	5	
KFB16	1	5	
KFB20	1 1/4	1	
KFB24	1 1/2	1	
KFB32	2	1	
KFB40X	2 1/2	1	
KFB48X	3	1	
KFB64X	4	1	

**EXTENSION ADAPTER**

BLACK IRON PIPE FITTING

Line: 917-01

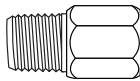

PART NO.	SIZE	QTY/BX	LIST PRICE
AAL06	3/8M X 3/8F	5	
AAL08	1/2M X 3/8F	5	

**SCHEDULE 40 PIPE NIPPLE**

GALVANIZED IRON

Line: 918-00



PART NO.	SIZE	QTY/BX	LIST PRICE
GJB02	1/8 CLOSE	10	
GJB02048	1/8 X 1 1/2	5	
GJB02064	1/8 X 2	5	
GJB02080	1/8 X 2 1/2	5	
GJB02096	1/8 X 3	5	
GJB02112	1/8 X 3 1/2	5	
GJB02128	1/8 X 4	5	
GJB02144	1/8 X 4 1/2	5	
GJB02160	1/8 X 5	5	
GJB02176	1/8 X 5 1/2	5	
GJB02192	1/8 X 6	5	
GJB02224	1/8 X 7	5	
GJB02256	1/8 X 8	1	
GJB02288	1/8 X 9	1	
GJB02320X	1/8 X 10	1	
GJB02384	1/8 X 12	5	
GJB04	1/4 CLOSE	10	
GJB04048	1/4 X 1 1/2	5	
GJB04064	1/4 X 2	5	
GJB04080	1/4 X 2 1/2	5	
GJB04096	1/4 X 3	5	
GJB04112	1/4 X 3 1/2	5	
GJB04128	1/4 X 4	5	
GJB04144	1/4 X 4 1/2	5	
GJB04160	1/4 X 5	5	
GJB04176	1/4 X 5 1/2	5	
GJB04192	1/4 X 6	5	
GJB04224	1/4 X 7	1	
GJB04256	1/4 X 8	1	
GJB04288	1/4 X 9	1	
GJB04320	1/4 X 10	5	
GJB04384	1/4 X 12	1	
GJB06	3/8 CLOSE	10	
GJB06048	3/8 X 1 1/2	5	
GJB06064	3/8 X 2	5	
GJB06080	3/8 X 2 1/2	5	
GJB06096	3/8 X 3	5	
GJB06112	3/8 X 3 1/2	5	

(continued...)

**SCHEDULE 40 PIPE NIPPLE (continued)**

GALVANIZED IRON

Line: 918-00



PART NO.	SIZE	QTY/BX	LIST PRICE
GJB06128	3/8 X 4	5	
GJB06144	3/8 X 4 1/2	5	
GJB06160	3/8 X 5	5	
GJB06176	3/8 X 5 1/2	5	
GJB06176D	3/8 X 5 1/2	5	
GJB06192	3/8 X 6	5	
GJB06208	3/8 X 6 1/2	1	
GJB06224	3/8 X 7	1	
GJB06256	3/8 X 8	1	
GJB06320	3/8 X 10	5	
GJB06384	3/8 X 12	5	
GJB08	1/2 CLOSE	10	
GJB08048	1/2 X 1 1/2	5	
GJB08064	1/2 X 2	5	
GJB08080	1/2 X 2 1/2	5	
GJB08096	1/2 X 3	5	
GJB08112	1/2 X 3 1/2	5	
GJB08128	1/2 X 4	5	
GJB08144	1/2 X 4 1/2	5	
GJB08160	1/2 X 5	5	
GJB08176	1/2 X 5 1/2	5	
GJB08192	1/2 X 6	5	
GJB08224	1/2 X 7	1	
GJB08256	1/2 X 8	1	
GJB08288	1/2 X 9	1	
GJB08320	1/2 X 10	1	
GJB08384X	1/2 X 12	1	
GJB12	3/4 CLOSE	10	
GJB12048	3/4 X 1 1/2	5	
GJB12064	3/4 X 2	5	
GJB12080	3/4 X 2 1/2	5	
GJB12096	3/4 X 3	5	
GJB12112	3/4 X 3 1/2	5	
GJB12128	3/4 X 4	5	
GJB12144	3/4 X 4 1/2	5	
GJB12160	3/4 X 5	5	
GJB12176	3/4 X 5 1/2	5	
GJB12192	3/4 X 6	5	
GJB12224	3/4 X 7	1	
GJB12256	3/4 X 8	1	
GJB12320	3/4 X 10	1	
GJB12352	3/4 X 11	1	
GJB12384	3/4 X 12	5	
GJB16	1 CLOSE	5	

(continued...)

**SCHEDULE 40 PIPE NIPPLE** (continued)

GALVANIZED IRON

Line: 918-00



PART NO.	SIZE	QTY/BX	LIST PRICE
GJB16064	1 X 2	5	
GJB16080	1 X 2 1/2	5	
GJB16096	1 X 3	5	
GJB16112	1 X 3 1/2	5	
GJB16128	1 X 4	5	
GJB16144	1 X 4 1/2	5	
GJB16160	1 X 5	5	
GJB16176	1 X 5 1/2	5	
GJB16192	1 X 6	5	
GJB16224	1 X 7	1	
GJB16256	1 X 8	1	
GJB16320	1 X 10	1	
GJB16384	1 X 12	5	
GJB20	1 1/4 CLOSE	1	
GJB20064	1 1/4 X 2	1	
GJB20080	1 1/4 X 2 1/2	1	
GJB20096	1 1/4 X 3	1	
GJB20112	1 1/4 X 3 1/2	1	
GJB20128	1 1/4 X 4	1	
GJB20144	1 1/4 X 4 1/2	1	
GJB20160	1 1/4 X 5	1	
GJB20176	1 1/4 X 5 1/2	1	
GJB20192	1 1/4 X 6	1	
GJB20224	1 1/4 X 7	1	
GJB20256	1 1/4 X 8	1	
GJB24	1 1/2 CLOSE	1	
GJB24064	1 1/2 X 2	1	
GJB24080	1 1/2 X 2 1/2	1	
GJB24096	1 1/2 X 3	1	
GJB24112	1 1/2 X 3 1/2	1	
GJB24128	1 1/2 X 4	1	
GJB24144	1 1/2 X 4 1/2	1	
GJB24160	1 1/2 X 5	1	
GJB24176	1 1/2 X 5 1/2	1	
GJB24192	1 1/2 X 6	1	
GJB24224	1 1/2 X 7	1	
GJB24256	1 1/2 X 8	1	
GJB24320	1 1/2 X 10	1	
GJB32	2 CLOSE	1	
GJB32080	2 X 2 1/2	1	
GJB32096	2 X 3	1	
GJB32112	2 X 3 1/2	1	
GJB32128	2 X 4	1	

(continued...)

**SCHEDULE 40 PIPE NIPPLE** (continued)

GALVANIZED IRON

Line: 918-00



PART NO.	SIZE	QTY/BX	LIST PRICE
GJB32160	2 X 5	1	
GJB32176	2 X 5 1/2	1	
GJB32192	2 X 6	1	
GJB32224	2 X 7	1	
GJB32256	2 X 8	1	
GJB32288	2 X 9	1	
GJB32320	2 X 10	1	
GJB48	3 CLOSE	1	
GJB48128	3 X 4	1	
GJB48160	3 X 5	1	
GJB48192	3 X 6	1	
GJB48384	3 X 12	1	
GJB64	4 CLOSE	1	
GJB64128	4 X 4	1	
GJB64192	4 X 6	1	
GJB64384	4 X 12	1	

**STANDARD PIPE COUPLING**

GALVANIZED IRON

Line: 921-00

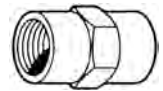

PART NO.	SIZE	QTY/BX	LIST PRICE
GWB02	1/8	5	
GWB04	1/4	5	
GWB06	3/8	5	
GWB08	1/2	5	
GWB12	3/4	5	
GWB16	1	5	
GWB20	1 1/4	1	
GWB24	1 1/2	1	
GWB32	2	1	
GWB48	3	1	
GWB64	4	1	



### SQUARE PIPE PLUG

GALVANIZED STEEL

Line: 923-00



PART NO.	SIZE	QTY/BX	LIST PRICE
HJB02	1/8	10	
HJB04	1/4	10	
HJB06	3/8	10	
HJB08	1/2	10	
HJB12	3/4	5	

### HEX PIPE CAP

GALVANIZED STEEL

Line: 929-00



PART NO.	SIZE	QTY/BX	LIST PRICE
HXB02	1/8	10	
HXB04	1/4	10	
HXB06	3/8	10	
HXB08	1/2	5	
HXB12	3/4	5	

### HEX PIPE PLUG

GALVANIZED STEEL

Line: 924-00

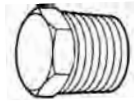

PART NO.	SIZE	QTY/BX	LIST PRICE
HLB02	1/8	10	
HLB04	1/4	10	
HLB06	3/8	10	
HLB08	1/2	10	
HLB12	3/4	5	

### HEX PIPE BUSHING

GALVANIZED STEEL

Line: 930-00



PART NO.	SIZE	QTY/BX	LIST PRICE
HZB0402	1/4 X 1/8	10	
HZB0602	3/8 X 1/8	10	
HZB0604	3/8 X 1/4	10	
HZB0802	1/2 X 1/8	10	
HZB0804	1/2 X 1/4	10	
HZB0806	1/2 X 3/8	10	
HZB1202	3/4 X 1/8	5	
HZB1204	3/4 X 1/4	5	
HZB1206	3/4 X 3/8	5	
HZB1208	3/4 X 1/2	5	

### SLOTTED PIPE PLUG

GALVANIZED STEEL

Line: 926-00



PART NO.	SIZE	QTY/BX	LIST PRICE
HRB02	1/8	10	
HRB04	1/4	10	
HRB06	3/8	10	

### FACE BUSHING

GALVANIZED STEEL

Line: 931-00



PART NO.	SIZE	QTY/BX	LIST PRICE
JBB0806	1/2 X 3/8	5	
JBB1208	3/4 X 1/2	5	

### HEX COUNTERSUNK PIPE PLUG

GALVANIZED STEEL

Line: 927-00

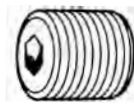

PART NO.	SIZE	QTY/BX	LIST PRICE
HTB02	1/8	10	
HTB04	1/4	10	
HTB06	3/8	10	
HTB08	1/2	10	
HTB12	3/4	5	
HTB16	1	5	
HTB20	1 1/4	5	

### COUNTERSUNK SQUARE PLUG

GALVANIZED CAST IRON

Line: 932-00



PART NO.	SIZE	QTY/BX	LIST PRICE
KJB12	3/4	5	
KJB16	1	5	
KJB20	1 1/4	5	
KJB24	1 1/2	1	
KJB32	2	5	

### SQUARE COUNTERSUNK PIPE PLUG

GALVANIZED STEEL

Line: 928-00



PART NO.	SIZE	QTY/BX	LIST PRICE
HVB02	1/8	10	
HVB04	1/4	10	
HVB06	3/8	10	
HVB08	1/2	10	
HVB12	3/4	5	
HVB16	1	5	

## SQUARE PIPE PLUG

GALVANIZED CAST IRON

Line: 933-00

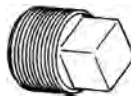

PART NO.	SIZE	QTY/BX	LIST PRICE
KLB12	3/4	5	
KLB16	1	5	
KLB20	1 1/4	1	
KLB24	1 1/2	1	
KLB32	2	1	
KLB40	2 1/2	1	
KLB48	3	1	

## FLOOR FLANGE

GALVANIZED CAST IRON

Line: 934-00



PART NO.	SIZE	QTY/BX	LIST PRICE
KNB08	1/2	5	
KNB12	3/4	5	
KNB16	1	5	
KNB20X	1 1/4	1	
KNB24X	1 1/2	1	
KNB32X	2	1	

## 150LB. PIPE UNION

GALVANIZED MALLEABLE

Line: 935-00

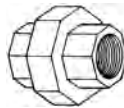

PART NO.	SIZE	QTY/BX	LIST PRICE
HCB02	1/8	5	
HCB04	1/4	5	
HCB06	3/8	5	
HCB08	1/2	5	
HCB12	3/4	5	
HCB16	1	5	
HCB20	1 1/4	1	
HCB24	1 1/2	1	
HCB32	2	1	
HCB48	3	1	
HCB64	4	1	

## 300LB. PIPE UNION

GALVANIZED MALLEABLE

Line: 937-00

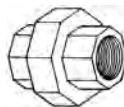

PART NO.	SIZE	QTY/BX	LIST PRICE
HGB08	1/2	5	
HGB12	3/4	1	
HGB16	1	1	
HGB20	1 1/4	1	
HGB24	1 1/2	1	

## HEX PIPE BUSHING

GALVANIZED MALLEABLE

Line: 938-00

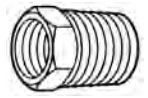

PART NO.	SIZE	QTY/BX	LIST PRICE
JDB1202	3/4 X 1/8	5	
JDB1204	3/4 X 1/4	5	
JDB1206	3/4 X 3/8	5	
JDB1208	3/4 X 1/2	5	
JDB1602	1 X 1/8	5	
JDB1604	1 X 1/4	5	
JDB1606	1 X 3/8	5	
JDB1608	1 X 1/2	5	
JDB1612	1 X 3/4	5	
JDB2004	1 1/4 X 1/4	1	
JDB2006	1 1/4 X 3/8	1	
JDB2008	1 1/4 X 1/2	1	
JDB2012	1 1/4 X 3/4	1	
JDB2016	1 1/4 X 1	1	
JDB2404	1 1/2 X 1/4	5	
JDB2406	1 1/2 X 3/8	1	
JDB2408	1 1/2 X 1/2	1	
JDB2412	1 1/2 X 3/4	1	
JDB2416	1 1/2 X 1	1	
JDB2420	1 1/2 X 1 1/4	1	
JDB3208	2 X 1/2	1	
JDB3212	2 X 3/4	1	
JDB3216	2 X 1	1	
JDB3220	2 X 1 1/4	1	
JDB3224	2 X 1 1/2	1	
JDB4024	2 1/2 X 1 1/2	1	
JDB4812	3 X 3/4	1	
JDB4832	3 X 2	1	
JDB6412	4 X 3/4	1	
JDB6448	4 X 3	1	

## 90° REDUCING ELBOW

GALVANIZED MALLEABLE

Line: 939-00



PART NO.	SIZE	QTY/BX	LIST PRICE
JFB0402	1/4 X 1/8	5	
JFB0604	3/8 X 1/4	5	
JFB0804	1/2 X 1/4	5	
JFB0806	1/2 X 3/8	5	
JFB1206	3/4 X 3/8	5	
JFB1208	3/4 X 1/2	5	
JFB1608	1 X 1/2	5	
JFB1612	1 X 3/4	5	
JFB2008X	1 1/4 X 1/2	1	
JFB2016	1 1/4 X 1	1	
JFB2420	1 1/2 X 1 1/4	1	

## REDUCER

GALVANIZED MALLEABLE

Line: 941-00



PART NO.	SIZE	QTY/BX	LIST PRICE
JKB0402	1/4 X 1/8	5	
JKB0602	3/8 X 1/8	5	
JKB0604	3/8 X 1/4	5	
JKB0802	1/2 X 1/8	5	
JKB0804	1/2 X 1/4	5	
JKB0806	1/2 X 3/8	5	
JKB1202X	3/4 X 1/8	5	
JKB1204	3/4 X 1/4	5	
JKB1206	3/4 X 3/8	5	
JKB1208	3/4 X 1/2	5	
JKB1604	1 X 1/4	5	
JKB1606	1 X 3/8	5	
JKB1608	1 X 1/2	5	
JKB1612	1 X 3/4	5	
JKB2008	1 1/4 X 1/2	1	
JKB2012	1 1/4 X 3/4	1	
JKB2016	1 1/4 X 1	1	
JKB2408X	1 1/2 X 1/2	1	
JKB2412	1 1/2 X 3/4	1	
JKB2416	1 1/2 X 1	1	
JKB2420	1 1/2 X 1 1/4	1	
JKB3208	2 X 1/2	1	
JKB3212	2 X 3/4	1	
JKB3216	2 X 1	1	
JKB3220	2 X 1 1/4	1	
JKB3224	2 X 1 1/2	1	
JKB4020	2 1/2 X 1 1/4	1	
JKB4032	2 1/2 X 2	1	
JKB4832	3 X 2	1	
JKB6448	4 X 3	1	

## 45° FEMALE PIPE ELBOW

GALVANIZED MALLEABLE

Line: 942-00



PART NO.	SIZE	QTY/BX	LIST PRICE
JPB02	1/8	5	
JPB04	1/4	5	
JPB06	3/8	5	
JPB08	1/2	5	
JPB12	3/4	5	
JPB16	1	5	
JPB20	1 1/4	1	
JPB24	1 1/2	1	
JPB32	2	1	

## 90° FEMALE PIPE ELBOW

GALVANIZED MALLEABLE

Line: 943-00



PART NO.	SIZE	QTY/BX	LIST PRICE
JSB02	1/8	5	
JSB04	1/4	5	
JSB06	3/8	5	
JSB08	1/2	5	
JSB12	3/4	5	
JSB16	1	5	
JSB20	1 1/4	1	
JSB24	1 1/2	1	
JSB32	2	1	
JSB48	3	1	
JSB64	4	1	

## 90° STREET PIPE ELBOW

GALVANIZED MALLEABLE

Line: 944-00



PART NO.	SIZE	QTY/BX	LIST PRICE
JUB02	1/8	5	
JUB04	1/4	5	
JUB06	3/8	5	
JUB08	1/2	5	
JUB12	3/4	5	
JUB16	1	5	
JUB20	1 1/4	1	
JUB24	1 1/2	1	
JUB32	2	1	
JUB48	3	1	

## 45° STREET PIPE ELBOW

GALVANIZED MALLEABLE

Line: 945-00



PART NO.	SIZE	QTY/BX	LIST PRICE
JWB02	1/8	5	
JWB04	1/4	5	
JWB06	3/8	5	
JWB08	1/2	5	
JWB12	3/4	5	
JWB16	1	5	
JWB20	1 1/4	1	
JWB24	1 1/2	1	
JWB32	2	1	

## PIPE CAP

GALVANIZED MALLEABLE

Line: 950-00



PART NO.	SIZE	QTY/BX	LIST PRICE
KGB02	1/8	10	
KGB04	1/4	10	
KGB06	3/8	10	
KGB08	1/2	5	
KGB12	3/4	5	
KGB16	1	5	
KGB20	1 1/4	1	
KGB24	1 1/2	1	
KGB32	2	1	

## PIPE TEE

GALVANIZED MALLEABLE

Line: 947-00

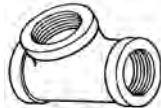

PART NO.	SIZE	QTY/BX	LIST PRICE
KAB02	1/8	5	
KAB04	1/4	5	
KAB06	3/8	5	
KAB08	1/2	5	
KAB12	3/4	5	
KAB16	1	5	
KAB20	1 1/4	1	
KAB24	1 1/2	1	
KAB32	2	1	
KAB48	3	1	
KAB64	4	1	

## PIPE NIPPLE

304 STAINLESS STEEL

Line: 951-00

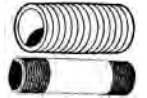

PART NO.	SIZE	QTY/BX	LIST PRICE
GSB02	1/8 CLOSE	5	
GSB02048	1/8 X 1 1/2	5	
GSB02064	1/8 X 2	5	
GSB02080	1/8 X 2 1/2	5	
GSB02096	1/8 X 3	5	
GSB02112	1/8 X 3 1/2	5	
GSB02128	1/8 X 4	5	
GSB02160	1/8 X 5	5	
GSB02176	1/8 X 5 1/2	5	
GSB02192	1/8 X 6	5	
GSB04	1/4 CLOSE	5	
GSB04048	1/4 X 1 1/2	5	
GSB04064	1/4 X 2	5	
GSB04080	1/4 X 2 1/2	5	
GSB04096	1/4 X 3	5	
GSB04112	1/4 X 3 1/2	5	
GSB04128	1/4 X 4	5	
GSB04144	1/4 X 4 1/2	5	
GSB04160	1/4 X 5	5	
GSB04192	1/4 X 6	5	
GSB06	3/8 CLOSE	5	
GSB06048	3/8 X 1 1/2	5	
GSB06064	3/8 X 2	5	
GSB06080	3/8 X 2 1/2	5	
GSB06096	3/8 X 3	5	
GSB06112	3/8 X 3 1/2	5	
GSB06128	3/8 X 4	5	
GSB06160	3/8 X 5	5	
GSB06192	3/8 X 6	5	
GSB08	1/2 CLOSE	5	
GSB08048	1/2 X 1 1/2	5	

## CROSS

GALVANIZED MALLEABLE

Line: 948-00



PART NO.	SIZE	QTY/BX	LIST PRICE
KCB02	1/8	5	
KCB04	1/4	5	
KCB06X	3/8	5	
KCB08	1/2	5	
KCB12	3/4	5	
KCB16	1	1	
KCB20	1 1/4	1	
KCB32	2	1	



CALL - 1 (800) 723-2826

(continued...)

**PIPE NIPPLE** (continued)

304 STAINLESS STEEL

Line: 951-00



PART NO.	SIZE	QTY/BX	LIST PRICE
GSB08064	1/2 X 2	5	
GSB08080	1/2 X 2 1/2	5	
GSB08096	1/2 X 3	5	
GSB08112	1/2 X 3 1/2	5	
GSB08128	1/2 X 4	5	
GSB08160	1/2 X 5	5	
GSB08192	1/2 X 6	5	
GSB12	3/4 CLOSE	5	
GSB12048	3/4 X 1 1/2	5	
GSB12064	3/4 X 2	5	
GSB12080	3/4 X 2 1/2	5	
GSB12096	3/4 X 3	5	
GSB12112	3/4 X 3 1/2	2	
GSB12128	3/4 X 4	5	
GSB12160	3/4 X 5	2	
GSB12192	3/4 X 6	2	
GSB16	1 CLOSE	5	
GSB16064	1 X 2	5	
GSB16080	1 X 2 1/2	2	
GSB16096	1 X 3	5	
GSB 16112	1 X 3 1/2	2	
GSB16128	1 X 4	2	
GSB16160	1 X 5	2	
GSB16192	1 X 6	2	
GSB20	1 1/4 CLOSE	2	
GSB20064	1 1/4 X 2	5	
GSB20080	1 1/4 X 2 1/2	2	
GSB20096	1 1/4 X 3	2	
GSB20112	1 1/4 X 3 1/2	5	
GSB20128	1 1/4 X 4	2	
GSB20160	1 1/4 X 5	2	
GSB20192	1 1/4 X 6	2	
GSB24	1 1/2 CLOSE	2	
GSB24096	1 1/2 X 3	2	
GSB24128	1 1/2 X 4	2	
GSB24160	1 1/2 X 5	2	
GSB24192	1 1/2 X 6	2	
GSB32	2 CLOSE	2	
GSB32128	2 X 4	1	
GSB32192	2 X 6	1	

**90° FEMALE ELBOW**

304 STAINLESS STEEL

Line: 952-00



PART NO.	SIZE	QTY/BX	LIST PRICE
LBB02	1/8	5	
LBB04	1/4	5	
LBB06	3/8	5	
LBB08	1/2	5	
LBB12	3/4	5	
LBB16	1	5	
LBB20	1 1/4	1	
LBB24	1 1/2	1	
LBB32	2	1	

**PIPE TEE**

304 STAINLESS STEEL

Line: 953-00



PART NO.	SIZE	QTY/BX	LIST PRICE
LCB02	1/8	5	
LCB04	1/4	5	
LCB06	3/8	5	
LCB08	1/2	5	
LCB12	3/4	5	
LCB16	1	5	
LCB20	1 1/4	1	
LCB24	1 1/2	1	
LCB32	2	1	

**45° FEMALE PIPE ELBOW**

304 STAINLESS STEEL

Line: 955-00



PART NO.	SIZE	QTY/BX	LIST PRICE
LEB02	1/8	5	
LEB04	1/4	5	
LEB06	3/8	5	
LEB08	1/2	5	
LEB12	3/4	5	
LEB16	1	5	
LEB20	1 1/4	1	
LEB24	1 1/2	1	
LEB32	2	1	

## 90° STREET PIPE ELBOW

304 STAINLESS STEEL

Line: 957-00



PART NO.	SIZE	QTY/BX	LIST PRICE
LGB02	1/8	5	
LGB04	1/4	5	
LGB06	3/8	5	
LGB08	1/2	5	
LGB12	3/4	5	
LGB16	1	5	
LGB20	1 1/4	1	
LGB24	1 1/2	1	

## PIPE COUPLING

304 STAINLESS STEEL

Line: 958-00

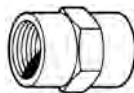

PART NO.	SIZE	QTY/BX	LIST PRICE
LHB02	1/8	5	
LHB04	1/4	5	
LHB06	3/8	5	
LHB08	1/2	5	
LHB12	3/4	5	
LHB16	1	5	
LHB20	1 1/4	1	
LHB24	1 1/2	1	
LHB32	2	1	

## PIPE CAP

304 STAINLESS STEEL

Line: 960-00



PART NO.	SIZE	QTY/BX	LIST PRICE
LKB02	1/8	5	
LKB04	1/4	5	
LKB06	3/8	5	
LKB08	1/2	5	
LKB12	3/4	5	
LKB16	1	5	
LKB20	1 1/4	1	
LKB24	1 1/2	1	
LKB32	2	1	
LKB48	3	1	

## SQUARE PIPE PLUG

304 STAINLESS STEEL

Line: 961-00



PART NO.	SIZE	QTY/BX	LIST PRICE
LLB02	1/8	5	
LLB04	1/4	5	
LLB06	3/8	5	
LLB08	1/2	5	
LLB12	3/4	5	
LLB16	1	5	
LLB20	1 1/4	1	
LLB24	1 1/2	1	
LLB32	2	1	

## HEX PIPE PLUG

304 STAINLESS STEEL

Line: 962-00

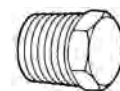

PART NO.	SIZE	QTY/BX	LIST PRICE
LMB02	1/8	5	
LMB04	1/4	5	
LMB06	3/8	5	
LMB08	1/2	5	
LMB12	3/4	5	
LMB16	1	5	
LMB20	1 1/4	1	
LMB24	1 1/2	1	

## PIPE UNION

304 STAINLESS STEEL

Line: 963-00

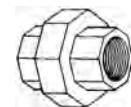

PART NO.	SIZE	QTY/BX	LIST PRICE
LNB02	1/8	5	
LNB04	1/4	5	
LNB06	3/8	5	
LNB08	1/2	5	
LNB12	3/4	5	
LNB16	1	1	
LNB20	1 1/4	1	
LNB24	1 1/2	1	
LNB32	2	1	
LNB40	2 1/2	1	



CALL - 1 (800) 723-2826

## REDUCER COUPLING

304 STAINLESS STEEL

Line: 966-00



PART NO.	SIZE	QTY/BX	LIST PRICE
MJB0402	1/4 X 1/8	5	
MJB0602	3/8 X 1/8	5	
MJB0604	3/8 X 1/4	5	
MJB0804	1/2 X 1/4	2	
MJB0806	1/2 X 3/8	2	
MJB1206	3/4 X 3/8	2	
MJB1208	3/4 X 1/2	5	
MJB1604	1 X 1/4	2	
MJB1606	1 X 3/8	2	
MJB1608	1 X 1/2	2	
MJB1612	1 X 3/4	2	
MJB2012	1 1/4 X 3/4	2	
MJB2016	1 1/4 X 1	1	
MJB2416	1 1/2 X 1	1	
MJB2420	1 1/2 X 1 1/4	1	
MJB3212	2 X 3/4	1	
MJB3224	2 X 1 1/2	1	

## BUSHING

304 STAINLESS STEEL

Line: 967-00



PART NO.	SIZE	QTY/BX	LIST PRICE
MKB0402	1/4 X 1/8	5	
MKB0602	3/8 X 1/8	5	
MKB0604	3/8 X 1/4	5	
MKB0804	1/2 X 1/4	5	
MKB0806	1/2 X 3/8	5	
MKB1206	3/4 X 3/8	5	
MKB1208	3/4 X 1/2	5	
MKB1604	1 X 1/4	5	
MKB1606	1 X 3/8	5	
MKB1608	1 X 1/2	5	
MKB1612	1 X 3/4	2	
MKB2004	1 1/4 X 1/4	1	
MKB2012	1 1/4 X 3/4	1	
MKB2016	1 1/4 X 1	1	
MKB2416	1 1/2 X 1	1	
MKB2420	1 1/2 X 1 1/4	1	
MKB3204	2 X 1/4	1	

## SQUARE PIPE PLUG

304 STAINLESS STEEL

Line: 975-00



PART NO.	SIZE	QTY/BX	LIST PRICE
KPB04X	1/4	1	
KPB06	3/8	1	
KPB08	1/2	1	
KPB12	3/4	1	
KPB16	1	1	
KPB20	1 1/4	1	
KPB24	1 1/2	1	
KPB32	2	1	
KPB40	2 1/2	1	
KPB48	3	1	

## FEMALE PIPE THREAD CHECK VALVE

BRONZE

Line: 992-01



PART NO.	SIZE	QTY/BX	LIST PRICE
AXP501	1/2 FPT	1	
AXP502	3/4 FPT	1	
AXP503	1 FPT	1	
AXP504	1 1/4 FPT	1	
AXP505	1 1/2 FPT	1	
AXP506	2 FPT	1	
AXP507	2 1/2 FPT	1	
AXP508	3 FPT	1	
AXP509	4 FPT	1	

## SWING CHECK VALVE

BRASS - 150 PSI THREADED

Line: 992-02



PART NO.	SIZE	QTY/BX	LIST PRICE
BHX101001	1/4 FPT	1	
BHX101002	3/8 FPT	1	
BHX101003	1/2 FPT	1	
BHX101004	3/4 FPT	1	
BHX101005	1 FPT	1	
BHX101006	1 1/4 FPT	1	
BHX101007	1 1/2 FPT	1	
BHX101008	2 FPT	1	

## SWING Y CHECK VALVE

BRONZE - 300 PSI

Line: 992-03

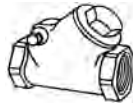

PART NO.	SIZE	QTY/BX	LIST PRICE
BHY101203	1/2 FPT	1	
BHY101204	3/4 FPT	1	
BHY101205	1 FPT	1	
BHY101206	1 1/4 FPT	1	
BHY101207	1 1/2 FPT	1	
BHY101208	2 FPT	1	

## HEAVY DUTY HOSE BIBBS

BRASS - 3/4" GARDEN HOSE THREAD

Line: 992-04



PART NO.	SIZE	QTY/BX	LIST PRICE
BHZ103003	1/2 STND MPT	1	
BHZ103013	1/2 MPT HEAVY DUTY	1	
BHZ103004	3/4 STND MPT	1	
BHZ103014	3/4 MPT HEAVY DUTY	1	

## NO/KINK HOSE BIBBS

BRONZE - 3/4" GARDEN HOSE THREAD

Line: 992-05



PART NO.	SIZE	QTY/BX	LIST PRICE
BJD102303	1/2 MPT	1	
BJD102304	3/4 MPT	1	
BJD102404	3/4 FPT	1	



**CALL - 1 (800) 723-2826**



# SECTION 12 PRODUCT INDEX



Line Description	Alpha	Line#	Page#
POP BLIND RIVETS - ALUMINUM/ALUMINUM	NBB	993-00	12-3
POP BLIND RIVETS - ALUMINUM/STEEL	NCB	994-00	12-3
POP BLIND RIVETS - STEEL/STEEL	NDB	995-00	12-4
POP BLIND RIVETS - STAINLESS/STAINLESS	NEB	996-00	12-4
POP BLIND RIVETS - STAINLESS/STEEL	JLD	997-00	12-5
EXTRA LONG BLIND RIVETS (METRIC) - ALUMINUM/STEEL	JVP	997-01	12-5
POP CLOSED END BLIND RIVETS - ALUMINUM/STEEL	JWP	997-02	12-5
POP CLOSED END BLIND RIVETS - ALUMINUM/ALUMINUM	JCS	997-03	12-5
POP BLIND RIVETS - COPPER RIVET/STEEL NAIL	ASC	997-10	12-5
POP MULTI GRIP BLIND RIVETS - ALUMINUM/STEEL	CAN	997-11	12-6
POP STRUCTURAL T BLIND RIVETS - ALUMINUM/STEEL	CAP	997-12	12-6
ROUND STEEL BACK UP WASHERS	NGB	999-00	12-6
ROUND ALUMINUM BACK UP WASHERS	NGB	1000-00	12-6
POP ULTRA GRIP RIVETS (MONOBOLT) - ALUMINUM/ALUMINUM	AFK	1000-08	12-6
POP ULTRA GRIP RIVETS (MONOBOLT) - STEEL/STEEL	AFL	1000-09	12-6
POP ULTRA GRIP RIVETS (MONOBOLT) - STAINLESS/STAINLESS	AFM	1000-10	12-6
BLIND RIVET NUT FLAT HEAD - ALUMINUM	JMD	1001-00	12-6
BLIND RIVET NUT FLAT HEAD - STEEL	JMD	1002-00	12-7
PREMIUM HAND RIVETING TOOL	NFB	1005-00	12-7
LEVER STYLE RIVET TOOL 1/4" CAPACITY	NFB	1006-00	12-7
LAZY TONG RIVET TOOL 1/4" CAPACITY	NFB	1007-00	12-7
PNEUMATIC/HYDRAULIC POWER RIVET TOOL	NFB	1009-00	12-7
RIVET TOOL KIT IN TRAY	NFB	1012-00	12-7
BLIND RIVET NUT HAND TOOL	JMD	1013-00	12-7
BLIND RIVET NUT HAND TOOL - LEVER STYLE	JMD	1015-00	12-7
NUT SERT (AT) SERIES CAD/STEEL	JKZ	1015-01	12-7
SIZE CONVERSION KITS FOR (AT) NUT SERIES	JLZ	1015-02	12-8
HI-TORQUER MANUAL TOOL	JMZ	1015-03	12-8
NUT SERT ASSORTMENT KITS	JNZ	1015-04	12-8
NUT SERT (AL)SERIES - ALUMINUM	BPR	1015-06	12-8
NUT SERT (AL)SERIES - STEEL YELLOW ZINC	BPT	1015-07	12-9
(AL)SERIES INSERT SETTING TOOLS	BPV	1015-08	12-9
(AL)SERIES TOOL CONVERSION KITS	BPW	1015-09	12-9
(AL)SERIES INSERT NUT KITS	BPX	1015-10	12-9
(AK) SERIES THREADED INSERTS - STEEL/YELLOW ZINC	CFL	1015-20	12-9
FULL BRAIZER 1100F SOFT ALUMINUM SOLID RIVETS	NHB	1016-00	12-10
UNIVERSAL HEAD 1100 SOFT ALUMINUM SOLID RIVETS	NLB	1019-00	12-10
UNIVERSAL HEAD 2117 T4 HARD ALUMINUM SOLID RIVETS	JUE	1020-08	12-10

(CONTINUED...)

# SECTION 12 PRODUCT INDEX

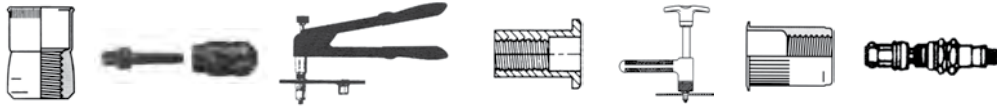

Line Description	Alpha	Line#	Page#
FULL BRAIZER HD 2117 T4 HARD ALUMINUM SOLID RIVETS	<b>NNB</b>	<b>1021-00</b>	<b>12-10</b>
FULL BRAIZER HD 1100F SOFT ALUMINUM SOLID RIVETS (LBS)	<b>JTD</b>	<b>1022-01</b>	<b>12-11</b>
FULL BRAIZER HD 2117 T4 HARD ALUMINUM SOLID RIVETS (LBS)	<b>JUD</b>	<b>1022-02</b>	<b>12-11</b>
TRUSS HEAD NYLON TAP-IT RIVET W/STEEL NAIL	<b>NXB</b>	<b>1029-00</b>	<b>12-11</b>
FLAT HEAD NYLON TAP-IT RIVET W/STEEL NAIL	<b>NYB</b>	<b>1030-00</b>	<b>12-11</b>
UNIVERSAL HD PIN DRIVE RIVET - ALUMINUM	<b>PCB</b>	<b>1034-00</b>	<b>12-12</b>
FULL BRAZIER HD PIN DRIVE RIVET - ALUMINUM	<b>PEB</b>	<b>1036-00</b>	<b>12-13</b>
3-G LINER HEAD PIN DRIVE RIVET - ALUMINUM	<b>PJB</b>	<b>1040-00</b>	<b>12-13</b>



**CALL - 1 (800) 723-2826**

**BLIND RIVET**

ALUMINUM RIVET/ALUMINUM NAIL

Line: 993-00

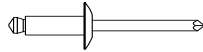

PART NUMBER	SIZE	QTY/BX	LIST PRICE
NBBGAMD32A	3-2 BUTTON HEAD	500	
NBBGAMD34A	3-4 BUTTON HEAD	500	
NBBGAMD41A	4-1 BUTTON HEAD	500	
NBBGAMD42A	4-2 BUTTON HEAD	500	
NBBGAMD42DBRZ	4-2 BUTTON HEAD DARK BRONZE	500	
NBBGAMD42DB	4-2 BUTTON HEAD DARK BROWN	500	
NBBGAMD42AW	4-2 BUTTON HEAD WHITE	500	
NBBGAMC42A	4-2 COUNTERSUNK HEAD	500	
NBBGAML42A	4-2 FLANGE HEAD	500	
NBBGAMD43A	4-3 BUTTON HEAD	500	
NBBGAMD43DBRZ	4-3 BUTTON HEAD DARK BRONZE	500	
NBBGAMC43A	4-3 COUNTERSUNK HEAD	500	
NBBGAMD44A	4-4 BUTTON HEAD	500	
NBBGAMD44DBRZ	4-4 BUTTON HEAD DARK BRONZE	500	
NBBGAMD44DB	4-4 BUTTON HEAD DARK BROWN	500	
NBBGAMD44AW	4-4 BUTTON HEAD WHITE	500	
NBBGAMC44A	4-4 COUNTERSUNK HEAD	500	
NBBGAML44A	4-4 LARGE FLANGE HEAD	500	
NBBGAMD45A	4-5 BUTTON HEAD	500	
NBBGAMC45A	4-5 COUNTERSUNK HEAD	500	
NBBGAMD46A	4-6 BUTTON HEAD	500	
NBBGAML46A	4-6 LARGE FLANGE HEAD	500	
NBBGAMD48A	4-8 BUTTON HEAD	500	
NBBGAMD52A	5-2 BUTTON HEAD	500	
NBBGAMD53A	5-3 BUTTON HEAD	500	
NBBGAMD54A	5-4 BUTTON HEAD	500	
NBBGAMC54A	5-4 COUNTERSUNK HEAD	500	
NBBGAMD56A	5-6 BUTTON HEAD	500	
NBBGAMC56A	5-6 COUNTERSUNK HEAD	500	
NBBGAMD58A	5-8 BUTTON HEAD	500	
NBBGAMD62A	6-2 BUTTON HEAD	500	
NBBGAMD64A	6-4 BUTTON HEAD	500	
NBBGAMC64A	6-4 COUNTERSUNK HEAD	500	
NBBGAML64A	6-4 LARGE FLANGE HEAD	250	
NBBGAMD66A	6-6 BUTTON HEAD	500	
NBBGAML66A	6-6 LARGE FLANGE HEAD	250	
NBBGAMD68A	6-8 BUTTON HEAD	500	
NBBGAML68A	6-8 LARGE FLANGE HEAD	250	
NBBGAMD610A	6-10 BUTTON HEAD	250	
NBBGAML610A	6-10 LARGE FLANGE HEAD	250	
NBBGAMD612A	6-12 BUTTON HEAD	250	
NBBGAML612A	6-12 LARGE FLANGE HEAD	250	
NBBGAMD614A	6-14 DOME HEAD	200	
NBBGAMD616A	6-16 DOME HEAD	200	

(continued...)

**BLIND RIVET (cont.)**

ALUMINUM RIVET/ALUMINUM NAIL

Line: 993-00

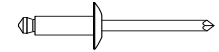

PART NUMBER	SIZE	QTY/BX	LIST PRICE
NBBGAMD84A	8-4 DOME HEAD	250	
NBBGAMD86A	8-6 BUTTON HEAD	250	
NBBGAMD88A	8-8 DOME HEAD	250	
NBBGAMD810A	8-10 DOME HEAD	200	
NBBGAMD812A	8-12 BUTTON HEAD	200	
NBBGAMD816A	8-16 BUTTON HEAD	200	

**BLIND RIVET**

ALUMINUM RIVET/STEEL NAIL

Line: 994-00

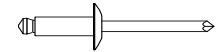

PART NUMBER	SIZE	QTY/BX	LIST PRICE
NCBGSM32A	3-2 BUTTON HEAD	500	
NCBGSM34A	3-4 BUTTON HEAD	500	
NCBGSM41A	4-1 BUTTON HEAD	500	
NCBGSM42A	4-2 BUTTON HEAD	500	
NCBGSMC42A	4-2 COUNTERSUNK HEAD	500	
NCBGSM42A	4-2 LARGE FLANGE HEAD	500	
NCBGSM43A	4-3 BUTTON HEAD	500	
NCBGSMC43A	4-3 COUNTERSUNK HEAD	500	
NCBGSM44A	4-4 BUTTON HEAD	500	
NCBGSMC44A	4-4 COUNTERSUNK HEAD	500	
NCBGSM44A	4-4 LARGE FLANGE HEAD	500	
NCBGSM45A	4-5 BUTTON HEAD	500	
NCBGSMC45A	4-5 COUNTERSUNK HEAD	500	
NCBGSM46A	4-6 BUTTON HEAD	500	
NCBGSM46A	4-6 LARGE FLANGE HEAD	500	
NCBGSM48A	4-8 BUTTON HEAD	500	
NCBGSM410A	4-10 BUTTON HEAD	500	
NCBGSM52A	5-2 BUTTON HEAD	500	
NCBGSM53A	5-3 BUTTON HEAD	500	
NCBGSM54A	5-4 BUTTON HEAD	500	
NCBGSMC54A	5-4 COUNTERSUNK HEAD	500	
NCBGSM56A	5-6 BUTTON HEAD	500	
NCBGSMC56A	5-6 COUNTERSUNK HEAD	500	
NCBGSM58A	5-8 BUTTON HEAD	500	
NCBGSM62A	6-2 BUTTON HEAD	500	
NCBGSM64A	6-4 BUTTON HEAD	500	
NCBGSMC64A	6-4 COUNTERSUNK HEAD	500	
NCBGSM64A	6-4 LARGE FLANGE HEAD	250	
NCBGSM66A	6-6 BUTTON HEAD	500	
NCBGSM66A	6-6 LARGE FLANGE HEAD	250	
NCBGSM68A	6-8 BUTTON HEAD	500	
NCBGSM68A	6-8 LARGE FLANGE HEAD	250	
NCBGSM610A	6-10 BUTTON HEAD	250	
NCBGSM610A	6-10 LARGE FLANGE HEAD	250	
NCBGSM612A	6-12 BUTTON HEAD	250	
NCBGSM612A	6-12 LARGE FLANGE HEAD	250	
NCBGSM614A	6-14 DOME HEAD	250	
NCBGSM610A	6-10 BUTTON HEAD	250	

(continued...)

**BLIND RIVET** (cont.)

ALUMINUM RIVET/STEEL NAIL

Line: 994-00

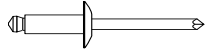

PART NUMBER	SIZE	QTY/BX	LIST PRICE
NCBGSML610A	6-10 LARGE FLANGE HEAD	250	
NCBGSMD612A	6-12 BUTTON HEAD	250	
NCBGSML612A	6-12 LARGE FLANGE HEAD	250	
NCBGSMD614A	6-14 BUTTON HEAD	250	
NCBGSML614A	6-14 LARGE FLANGE HEAD	250	
NCBGSMD616A	6-16 BUTTON HEAD	250	
NCBGSMD84A	8-4 DOME HEAD	200	
NCBGSMD86A	8-6 BUTTON HEAD	100	
NCBGSMD88A	8-8 BUTTON HEAD	100	
NCBGSMD810A	8-10 BUTTON HEAD	200	
NCBGSMD812A	8-12 BUTTON HEAD	200	
NCBGSMD816A	8-16 BUTTON HEAD	200	

**BLIND RIVET**

STEEL RIVET/STEEL NAIL

Line: 995-00

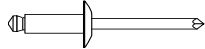

PART NUMBER	SIZE	QTY/BX	LIST PRICE
NDBGSM32S	3-2 BUTTON HEAD	500	
NDBGSM34S	3-4 BUTTON HEAD	500	
NDBGSM41S	4-1 BUTTON HEAD	500	
NDBGSM42S	4-2 BUTTON HEAD	500	
NDBGSMC42S	4-2 COUNTERSUNK HEAD	500	
NDBGSM42S	4-2 LARGE FLANGE HEAD	500	
NDBGSM43S	4-3 BUTTON HEAD	500	
NDBGSMC43S	4-3 COUNTERSUNK HEAD	500	
NDBGSM44S	4-4 BUTTON HEAD	500	
NDBGSMC44S	4-4 COUNTERSUNK HEAD	500	
NDBGSM44S	4-4 LARGE FLANGE HEAD	500	
NDBGSM45S	4-5 BUTTON HEAD	500	
NDBGSMC45S	4-5 COUNTERSUNK HEAD	500	
NDBGSM46S	4-6 BUTTON HEAD	500	
NDBGSM46S	4-6 LARGE FLANGE HEAD	500	
NDBGSM48S	4-8 BUTTON HEAD	500	
NDBGSM52S	5-2 BUTTON HEAD	500	
NDBGSM53S	5-3 BUTTON HEAD	500	
NDBGSM54S	5-4 BUTTON HEAD	500	
NDBGSMC54S	5-4 COUNTERSUNK HEAD	500	
NDBGSM56S	5-6 BUTTON HEAD	500	
NDBGSMC56S	5-6 COUNTERSUNK HEAD	500	
NDBGSM58S	5-8 BUTTON HEAD	500	
NDBGSM62S	6-2 BUTTON HEAD	500	
NDBGSM64S	6-4 BUTTON HEAD	500	
NDBGSMC64S	6-4 COUNTERSUNK HEAD	500	
NDBGSM64S	6-4 LARGE FLANGE HEAD	250	
NDBGSM66S	6-6 BUTTON HEAD	500	

(continued...)

**BLIND RIVET** (cont.)

STEEL RIVET/STEEL NAIL

Line: 995-00

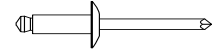

PART NUMBER	SIZE	QTY/BX	LIST PRICE
NDBGSM66S	6-6 LARGE FLANGE HEAD	250	
NDBGSM68S	6-8 BUTTON HEAD	500	
NDBGSM68S	6-8 LARGE FLANGE HEAD	250	
NDBGSM610S	6-10 BUTTON HEAD	250	
NDBGSM610S	6-10 FLANGE HEAD	250	
NDBGSM612S	6-12 BUTTON HEAD	250	
NDBGSM612S	6-12 LARGE FLANGE HEAD	250	
NDBGSM614S	6-14 BUTTON HEAD	250	
NDBGSM616S	6-16 BUTTON HEAD	250	
NDBGSM84S	8-4 BUTTON HEAD	250	
NDBGSM86S	8-6 BUTTON HEAD	250	
NDBGSM86S	8-6 LARGE FLANGE HEAD	200	
NDBGSM88S	8-8 BUTTON HEAD	100	
NDBGSM810S	8-10 BUTTON HEAD	200	
NDBGSM812S	8-12 BUTTON HEAD	200	
NDBGSM814S	8-14 BUTTON HEAD	200	
NDBGSM816S	8-16 BUTTON HEAD	200	

**BLIND RIVET**

STAINLESS RIVET/STAINLESS NAIL

Line: 996-00

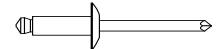

PART NUMBER	SIZE	QTY/BX	LIST PRICE
NEBGSSMD42SS	4-2 BUTTON HEAD	500	
NEBGSSML42SS	4-2 LARGE FLANGE	500	
NEBGSSMD43SS	4-3 BUTTON HEAD	500	
NEBGSSMD44SS	4-4 BUTTON HEAD	500	
NEBGSSML44SS	4-4 LARGE FLANGE	500	
NEBGSSMD46SS	4-6 BUTTON HEAD	500	
NEBGSSMD48SS	4-8 BUTTON HEAD	500	
NEBGSSMD52SS	5-2 BUTTON HEAD	500	
NEBGSSMD54SS	5-4 BUTTON HEAD	500	
NEBGSSMD56SS	5-6 BUTTON HEAD	500	
NEBGSSMD62SS	6-2 BUTTON HEAD	500	
NEBGSSMD64SS	6-4 BUTTON HEAD	500	
NEBGSSMD66SS	6-6 BUTTON HEAD	500	
NEBGSSML66SS	6-6 LARGE FLANGE	250	
NEBGSSMD68SS	6-8 BUTTON HEAD	500	
NEBGSSML68SS	6-8 LARGE FLANGE	250	

CALL: (800) 723-2826

**BLIND RIVET**

STAINLESS RIVET/STEEL NAIL

Line: 997-00

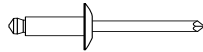

PART NUMBER	SIZE	QTY/BX	LIST PRICE
JLDGSMD42SS	4-2 BUTTON HEAD	500	
JLDGSMD43SS	4-3 BUTTON HEAD	500	
JLDGSMD44SS	4-4 BUTTON HEAD	500	
JLDGSMD46SS	4-6 BUTTON HEAD	500	
JLDGSMD48SS	4-8 BUTTON HEAD	500	
JLDGSMD52SS	5-2 BUTTON HEAD	500	
JLDGSMD54SS	5-4 BUTTON HEAD	500	
JLDGSMD56SS	5-6 BUTTON HEAD	500	
JLDGSMD62SS	6-2 BUTTON HEAD	500	
JLDGSMD64SS	6-4 BUTTON HEAD	500	
JLDGSMD66SS	6-6 BUTTON HEAD	500	
JLDGSMD68SS	6-8 BUTTON HEAD	500	

**EXTRA LONG BLIND RIVET (METRIC)**

ALUMINUM RIVET/STEEL NAIL

Line: 997-01

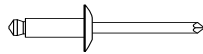

PART NUMBER	SIZE	QTY/BX	LIST PRICE
JVP04018	.157 DIA X .593 GRIP	500	
JVP04021	.157 DIA X .687 GRIP	500	
JVP04025	.157 DIA X .875 GRIP	500	
JVP03018	.188 DIA X .593 GRIP	250	
JVP03021	.188 DIA X .687 GRIP	500	
JVP03025	.188 DIA X .875 GRIP	500	
JVP05035	.197 DIA X 1.187 GRIP	100	
JVP05040	.197 DIA X 1.375 GRIP	100	
JVP05045	.197 DIA X 1.625 GRIP	100	
JVP05050	.197 DIA X 1.750 GRIP	100	
JVP05055	.197 DIA X 1.968 GRIP	100	
JVP05060	.197 DIA X 2.156 GRIP	100	
JVP05065	.197 DIA X 2.375 GRIP	100	
JVP05080	.197 DIA X 2.968 GRIP	100	

ABOVE SIZES IN DECIMAL INCH CONVERSION

**CLOSED END BLIND RIVET**

ALUMINUM RIVET/STEEL NAIL

Line: 997-02

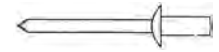

PART NUMBER	SIZE	QTY/BX	LIST PRICE
JWPGSMD41AC	4-1 BUTTON HEAD	500	
JWPGSMD42AC	4-2 BUTTON HEAD	500	
JWPGSMD43AC	4-3 BUTTON HEAD	500	
JWPGSMD44AC	4-4 BUTTON HEAD	500	
JWPGSMD45AC	4-5 BUTTON HEAD	500	
JWPGSMD52A	5-2 BUTTON HEAD	500	
JWPGSMD53A	5-3 BUTTON HEAD	500	
JWPGSMD54A	5-4 BUTTON HEAD	500	
JWPGSMD62AC	6-2 BUTTON HEAD	500	
JWPGSMD64AC	6-4 BUTTON HEAD	500	
JWPGSMD66AC	6-6 BUTTON HEAD	500	
JWPGSMD68AC	6-8 BUTTON HEAD	250	
JWPGSMD610A	6-10 BUTTON HEAD	250	

**CLOSED END BLIND RIVET**

ALUMINUM RIVET/ALUMINUM NAIL

Line: 997-03

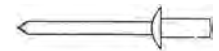

PART NUMBER	SIZE	QTY/BX	LIST PRICE
JCSAD42AH	4-2 DOME HEAD	500	
JCSAD43AH	4-3 DOME HEAD	500	
JCSAD44AH	4-4 DOME HEAD	500	
JCSAD54AH	5-4 DOME HEAD	500	
JCSAD62AH	6-2 DOME HEAD	500	
JCSAD64AH	6-4 DOME HEAD	500	
JCSAD66AH	6-6 DOME HEAD	500	
JCSAD68AH	6-8 DOME HEAD	250	

**BLIND RIVET**

COPPER RIVET/STEEL NAIL

Line: 997-10

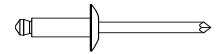

PART NUMBER	SIZE	QTY/BX	LIST PRICE
ASCCB42	4-2 BUTTON HEAD	500	
ASCCB44	4-4 BUTTON HEAD	500	



**CALL - 1 (800) 723-2826**

### POP MULTI/GRIP BLIND RIVET

ALUMINUM RIVET/STEEL NAIL

Line: 997-11

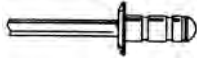

PART NUMBER	SIZE	QTY/BX	LIST PRICE
CANAD4143BS	1/8X-1-3 .039/.087 GRIP	500	
CANAD4345BS	1/8X-3-5 .157/.312 GRIP	500	
CANAD5254BS	5/32X-2-4 .047-.250 GRIP	500	
CANAD6264BS	3/16X-2-4 .063-.250 GRIP	250	
CANAD6264BSLF	3/16 FLANGE .063-.250 GRIP	250	
CANAD6366BS	3/16 X -3-6 .188-.375 GRIP	250	
CANAD6668BS	3/16 X -6-8 .251-.500 GRIP	250	
CANAD6668BSLF	3/16 FLANGE .251-.500 GRIP	250	

### POP STRUCTURAL T BLIND RIVET

ALUMINUM RIVET/STEEL NAIL

Line: 997-12



PART NUMBER	SIZE	QTY/BX	LIST PRICE
CAPAD6140TFBS	3/16X.032-.140 GRIP	250	
CAPAD6250TFBS	3/16X .188-.250 GRIP	250	
CAPAD6375TFBS	3/16X .313-.375 GRIP	250	
CAPAD8140TFBS	1/4 X .032-.140 GRIP	100	
CAPAD8187TFBS	1/4 X .141-.187 GRIP	100	
CAPAD8250TFBS	1/4 X .188-.250 GRIP	100	
CAPAD8519TFBS	1/4 X .437-.519 GRIP	100	
CAPAD8620TFBS	1/4 X .520-.620 GRIP	100	

### ROUND BACK UP RIVET WASHERS

STEEL

Line: 999-00



PART NUMBER	SIZE	QTY/BX	LIST PRICE
NGBGSRW-4	1/8	500	
NGBGSRW-6	3/16	500	
NGBGSRW6L	3/16 X 1/2 OD	500	

### ROUND BACK UP RIVET WASHERS

ALUMINUM

Line: 1000-00



PART NUMBER	SIZE	QTY/BX	LIST PRICE
NGBGARW-4	1/8	500	
NGBGARW-5	5/32	500	
NGBGARW-6	3/16	500	
NGBGARW6L	3/16 X 1/2 OD	500	

### POP ULTRA GRIP (MONOBOLT)

ALUMINUM NAIL/ALUMINUM RIVET

Line: 1000-08



PART NUMBER	SIZE	QTY/BX	LIST PRICE
AFKAD6270UG	3/16X .062-.270 GRIP	100	
AFKAD6437UGX	3/16X .214-.437 GRIP	100	
AFKBAPV64	3/16 X 1/4 BUTTON HEAD	500	
AFKAD8375UG	1/4 X .080-.375 GRIP	100	
AFKAD8625UGX	1/4X .350-.625 GRIP	100	

### POP ULTRA GRIP (MONOBOLT)

STEEL NAIL/STEEL RIVET

Line: 1000-09



PART NUMBER	SIZE	QTY/BX	LIST PRICE
AFLSD6270UG	3/16X .062-.270 GRIP	100	
AFLSD6437UGX	3/16X .214-.437 GRIP	100	
AFLSSPV67	3/16 X 7/16 BUTTON HEAD	500	
AFLSD8375UG	1/4X .080-.375 GRIP	100	
AFLSD8625UGX	1/4X .350-.625 GRIP	100	

### POP ULTRA GRIP (MONOBOLT)

STAINLESS STEEL NAIL/STAINLESS STEEL RIVET

Line: 1000-10



PART NUMBER	SIZE	QTY/BX	LIST PRICE
AFMSSD6270UG	3/16X .062-.270 GRIP	100	
AFMSSD8375UG	1/4X .080-.375 GRIP	100	

### FLAT ALUMINUM BLIND RIVET NUT

Line: 1001-00

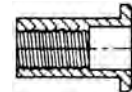

PART NUMBER	SIZE	QTY/BX	LIST PRICE
JMD632G075FA	6/32 X .075 GRIP	50	
JMD832G75FA	8/32 X .075 GRIP	50	
JMD832G120FA	8/32 X .120 GRIP	50	
JMD832G160FA	8/32 X .160 GRIP	50	
JMD1420G80FA	1/4-20 X .080 GRIP	50	
JMD1420G140FA	1/4-20 X .140 GRIP	50	
JMD1420G200FA	1/4-20 X .200 GRIP	50	
JMD1420G260FA	1/4-20 X .260 GRIP	50	
JMD1032G80FA	10/32 X .080 GRIP	50	
JMD1032G130FA	10/32 X .130 GRIP	50	
JMD1032G180FA	10/32 X .180 GRIP	50	
JMD516G125FA	5/16-18 X .125 GRIP	25	
JMD516G200FA	5/16-18 X .200 GRIP	25	
JMD516G275FA	5/16-18 X .275 GRIP	25	

## FLAT STEEL BLIND RIVET NUT

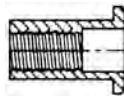

Line: 1002-00

PART NUMBER	SIZE	QTY/BX	LIST PRICE
JMD832G75FS	8/32 X .075 GRIP	50	
JMD832G120FS	8/32 X .120 GRIP	50	
JMD832G160FS	8/32 X .160 GRIP	50	
JMD1032G80FS	10/32 X .080 GRIP	50	
JMD1032G130FS	10/32 X .130 GRIP	50	
JMD1032G180FS	10/32 X .180 GRIP	50	
JMD1420G80FS	1/4-20 X .080 GRIP	50	
JMD1420G140FS	1/4-20 X .140 GRIP	50	
JMD1420G200FS	1/4-20 X .200 GRIP	50	
JMD1420G260FS	1/4-20 X .260 GRIP	50	
JMD516G125FS	5/16-18 X .125 GRIP	25	
JMD516G200FS	5/16-18 X .200 GRIP	25	
JMD516G275FS	5/16-18 X .275 GRIP	25	

## PREMIUM HAND RIVETING TOOL



Line: 1005-00

PART NUMBER	SIZE	QTY/BX	LIST PRICE
NFBPL30	POP POWERLINK PS15	1	

## LEVER STYLE HEAVY DUTY

1/4 CAP RIVETING TOOL



Line: 1006-00

PART NUMBER	SIZE	QTY/BX	LIST PRICE
NFBA450	1/4 MAX MANUAL	1	

## LAZY TONG HEAVY DUTY

1/4 CAP RIVETING TOOL



Line: 1007-00

PART NUMBER	SIZE	QTY/BX	LIST PRICE
NFBPRG440	1/4 MAX MANUAL	1	

## PNEUMATIC/HYDRAULIC

POWER RIVETING TOOL



Line: 1009-00

PART NUMBER	SIZE	QTY/BX	LIST PRICE
NFB510APLS	POP/3/16 RIVET CAP	1	
NFB540	POP1/4 CAP & MONO	1	

## HEAVY DUTY RIVETING KIT IN TRAY



Line: 1012-00

PART NUMBER	SIZE	QTY/BX	LIST PRICE
NFBNTXFKIT	W/CASE-RET/SPR	1	

## HAND STYLE BLIND RIVET NUT TOOL



Line: 1013-00

PART NUMBER	SIZE	QTY/BX	LIST PRICE
JMDGBM10KIT	W/CASE & NUTS	1	
JMDGBM10	1/4-20 MAX	1	

## LEVER STYLE BLIND RIVET NUT TOOL



Line: 1015-00

PART NUMBER	SIZE	QTY/BX	LIST PRICE
JMDGBM30	HVY DUTY 3/8-16 MAX	1	
JMDGBM20	1/4-20 MAX	1	

## AVK STEEL CAD AT NUTSERT



Line: 1015-01

PART NUMBER	SIZE	QTY/BX	LIST PRICE
JKZATS2350PK	M3 X 0.5 METRIC	50	
JKZATS2470PK	M4 X 0.7 METRIC	50	
JKZATS2580PK	M5 X 0.8 METRIC	50	
JKZATS2610	M6 X 1.0 METRIC	25	
JKZATS28125PK	M8 X 1.25 METRIC	25	
JKZATS21015PK	M10 X 1.5 METRIC	25	
JKZATS212175	M12 X 1.75 METRIC	25	
JKZATS2440	4/40 INCH	100	
JKZATS2632	6/32 INCH	100	
JKZATS2832	8/32 INCH	100	
JKZATS21024	10/24 INCH	100	
JKZATS21032	10/32 INCH	100	
JKZATS2420	1/4-20 INCH	50	
JKZATS2428	1/4-28 INCH	50	
JKZATS2518	5/16-18 INCH	50	
JKZATS2524PK	5/16-24 INCH	50	
JKZATS2616PK	3/8-16 INCH	25	
JKZATS2624PK	3/8-24 INCH	25	
JKZATS2813	1/2-13 INCH	25	

### AVK THREAD CONVERTER KITS

Line: 1015-02



PART NUMBER	SIZE	QTY/BX	LIST PRICE
JLZAAT202350	M3 X 0.5 METRIC	1	
JLZAAT202470	M4 X 0.7 METRIC	1	
JLZAAT202580	M5 X 0.8 METRIC	1	
JLZAAT202610	M6 X 1.0 METRIC	1	
JLZAAT2028125	M8 X 1.25 METRIC	1	
JLZAAT2021015	M10 X 1.5 METRIC	1	
JLZAAT202440	4/40 INCH	1	
JLZAAT202632	6/32 INCH	1	
JLZAAT202832	8/32 INCH	1	
JLZAAT2021024	10/24 INCH	1	
JLZAAT2021032	10/32 INCH	1	
JLZAAT202420	1/4-20 INCH	1	
JLZAAT202428	1/4-28 INCH	1	
JLZAAT202518	5/16-18 INCH	1	
JLZAAT202524	5/16-24 INCH	1	
JLZAAT202616	3/8-16 INCH	1	
JLZAAT202624	3/8-24 INCH	1	

### AVK HI-TORQUER MANUAL TOOL

Line: 1015-03



PART NUMBER	SIZE	QTY/BX	LIST PRICE
JMZA A112	T-HANDLE TOOL	1	
JMZA A184518	5/16-18 EXPENDABLE TOOL	1	

### AVK NUTSERT ASSORTED KITS

Line: 1015-04



PART NUMBER	SIZE	QTY/BX	LIST PRICE
JNZAAT312A	#4-5/16 INCH	1	
JNZAAT312BM	M3-M8 METRIC	1	

### AVK AL SERIES ALUMINUM INSERT

Line: 1015-06

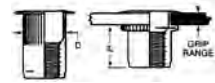

PART NUMBER	SIZE	QTY/BX	LIST PRICE
BPRALA1632080	6-32 X .080 GRIP	100	
BPRALA1632130	6-32 X .130 GRIP	100	
BPRALA1832080	8-32 X .080 GRIP	100	
BPRALA1832130	8-32 X .130 GRIP	100	
BPRALA1102413	10-24 X .130 GRIP	100	
BPRALA1102422	10-24 X .225 GRIP	100	
BPRALA1103213	10-32 X .130 GRIP	100	
BPRALA1103222	10-32 X .225 GRIP	100	
BPRALA1420165	1/4-20 X .165 GRIP	100	
BPRALA1420260	1/4-20 X .260 GRIP	100	
BPRALA1518150	5/16-18 X .150 GRIP	50	
BPRALA1518312	5/16-18 X .312 GRIP	50	
BPRALA1616150	3/8-16 X .150 GRIP	50	
BPRALA1616312	3/8-16 X .312 GRIP	50	
BPRALA1407200	M4-0.7 X 2.0MM GRIP	100	
BPRALA1407330	M4-0.7 X 3.3MM GRIP	100	
BPRALA1508330	M5-0.8 X 3.3MM GRIP	100	
BPRALA1508570	M5-0.8 X 5.7MM GRIP	100	
BPRALA161042	M6-1.0 X 4.2 MM GRIP	100	
BPRALA1610660	M6-1.0 X 6.6MM GRIP	100	
BPRALA1812538	M8-1.25 X 3.8MM GRIP	50	
BPRALA1812579	M8-1.25 X 7.9MM GRIP	50	
BPRALA1101579	M10-1.5 X 7.9MM GRIP	50	
BPRALA1101538	M10-1.5 X 3.8MM GRIP	50	



**CALL - 1 (800) 723-2826**

**CALL: (800) 723-2826**



## AVK AL SERIES STEEL INSERT

YELLOW ZINC

Line: 1015-07

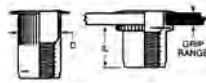

PART NUMBER	SIZE	QTY/BX	LIST PRICE
BPTALS4632080	6-32 X .080 GRIP	100	
BPTALS4632130	6-32 X .130 GRIP	100	
BPTALS4832080	8-32 X .080 GRIP	100	
BPTALS4832130	8-32 X .130 GRIP	100	
BPTALS4102413	10/24 X .130 GRIP	100	
BPTALS4102422	10/24 X .225 GRIP	100	
BPTALS4103213	10/32 X .130 GRIP	100	
BPTALS4103222	10/32 X .225 GRIP	100	
BPTALS4420165	1/4-20 X .165 GRIP	100	
BPTALS4420260	1/4-20 X .260 GRIP	100	
BPTALS4518150	5/16-18 X .150 GRIP	50	
BPTALS4518312	5/16-18 X .312 GRIP	50	
BPTALS4616150	3/8-16 X .150 GRIP	50	
BPTALS4616312	3/8-16 X .312 GRIP	50	
BPTALS4813200	1/2-13 X .200 GRIP	50	
BPTALS4813500	1/2-13 X .500 GRIP	50	
BPTALS4407200	M4-0.7 X 2.0MM GRIP	100	
BPTALS4407330	M4-0.7 X 3.3MM GRIP	100	
BPTALS4508330	M5-0.8 X 3.3MM GRIP	100	
BPTALS4508570	M5-0.8 X 5.7MM GRIP	100	
BPTALS461042	M6-1.0 X 4.2MM GRIP	100	
BPTALS4610660	M6-1.0 X 6.6MM GRIP	100	
BPTALS4812538	M8-1.25 X 3.8MM GRIP	50	
BPTALS4812579	M8-1.25 X 7.9MM GRIP	50	
BPTALS4101538	M10-1.5 X 3.8 GRIP	50	
BPTALS41015	M10-1.5 X 7.9MM GRIP	50	
BPTALS4121755	M12-1.75 X 5.1M GRIP	50	
BPTALS4121758	M12-1.75 X 8.9 GRIP	50	
BPTALS4121751	M12-1.75 X 12.7 GRIP	50	

## AVK AL SERIES INSERT NUT SETTING TOOL

Line: 1015-08



PART NUMBER	SIZE	QTY/BX	LIST PRICE
BPVAA170	PLIER INSTAL TOOL	1	
BPVAA480	DBL ACTION LEVER TOOL	1	
BPVAA510	HVY DTY LEVER 3/8 MX	1	

## AVK AL SERIES TOOL CONVERSION KITS

Line: 1015-09



PART NUMBER	SIZE	QTY/BX	LIST PRICE
BPWAA271632	6/32	1	
BPWAA271832	8/32	1	
BPWAA2711024	10/24	1	
BPWAA2711032	10/32	1	
BPWAA271420	1/4-20	1	
BPWAA481420	1/4-20 (LEVER TOOL)	1	
BPWAA271518	5/16-18	1	
BPWAA481518	5/16-18 (LEVER TOOL)	1	
BPWAA271616	3/8-16	1	
BPWAA481616	3/8-16 (LEVER TOOL)	1	
BPWAA271470	M4-0.7	1	
BPWAA271580	M5-0.8	1	
BPWAA271610	M6-1.0	1	
BPWAA481610	M6-1.0 (LEVER TOOL)	1	
BPWAA2718125	M8-1.25	1	
BPWAA2711015	M10-1.50	1	
BPWAA4811015	M10-1.5 (LEVER TOOL)	1	

## AVK AL SERIES INSERT NUT KITS



Line: 1015-10

PART NUMBER	SIZE	QTY/BX	LIST PRICE
BPXAVK2292	INCH KIT #6 THRU 3/8	1	
BPXAVK2293	METRIC KIT M4 - M10	1	

## AVK SERIES AK THREADED INSERTS

Line: 1015-20

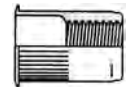

PART NUMBER	SIZE	QTY/BX	LIST PRICE
CFLAKS442016	1/4-20X.165 STL Y/Z	100	
CFLAKS442026	1/4-20X.260 STL Y/Z	100	

**FULL BRAIZER 1100F SOFT ALUMINUM**

SOLID RIVET PIECE COUNT

Line: 1016-00



PART NUMBER	SIZE	QTY/BX	LIST PRICE
NHB0604	3/16 X 1/4	500	
NHB0605	3/16 X 5/16	500	
NHB0606	3/16 X 3/8	500	
NHB0607	3/16 X 7/16	500	
NHB0608	3/16 X 1/2	500	
NHB0609	3/16 X 9/16	500	
NHB0610	3/16 X 5/8	500	
NHB0612	3/16 X 3/4	500	
NHB0616	3/16 X 1	500	
NHB0804	1/4 X 1/4	500	
NHB0805	1/4 X 5/16	500	
NHB0806	1/4 X 3/8	500	
NHB0807	1/4 X 7/16	500	
NHB0808	1/4 X 1/2	500	
NHB0810	1/4 X 5/8	500	
NHB0812	1/4 X 3/4	500	

**UNIVERSAL HD 1100F SOFT ALUMINUM**

SOLID RIVET PIECE COUNT

Line: 1019-00

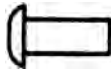

PART NUMBER	SIZE	QTY/BX	LIST PRICE
NLB0606	3/16 X 3/8	500	
NLB0607	3/16 X 7/16	500	
NLB0608	3/16 X 1/2	500	
NLB0610	3/16 X 5/8	500	
NLB0612	3/16 X 3/4	500	
NLB0616	3/16 X 1	500	
NLB0806	1/4 X 3/8	500	
NLB0807	1/4 X 7/16	500	
NLB0808	1/4 X 1/2	500	
NLB0810	1/4 X 5/8	500	
NLB0812	1/4 X 3/4	500	
NLB0816	1/4 X 1	500	

**UNIVERSAL HD 2117T4 HARD ALUMINUM**

SOLID RIVET PIECE COUNT

Line: 1020-08

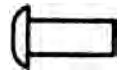

PART NUMBER	SIZE	QTY/BX	LIST PRICE
JUE0606X	3/16 X 3/8	500	
JUE03014	3/16 X 7/16	500	
JUE03016	3/16 X 1/2	500	
JUE03018	3/16 X 9/16	500	
JUE03020	3/16 X 5/8	500	
JUE03024	3/16 X 3/4	500	
JUE0804X	1/4 X 1/4	500	
JUE04012	1/4 X 3/8	500	
JUE04014	1/4 X 7/16	500	
JUE0808X	1/4 X 1/2	500	
JUE04020	1/4 X 5/8	500	
JUE0812X	1/4 X 3/4	500	

**FULL BRAZIER HD 2117T4 HARD ALUMINUM**

SOLID RIVET PIECE COUNT

Line: 1021-00



PART NUMBER	SIZE	QTY/BX	LIST PRICE
NNB0406	1/8 X 3/8	500	
NNB0604	3/16 X 1/4	500	
NNB0605	3/16 X 5/16	500	
NNB0606	3/16 X 3/8	500	
NNB0607	3/16 X 7/16	500	
NNB0608	3/16 X 1/2	500	
NNB0609	3/16 X 9/16	500	
NNB0610	3/16 X 5/8	500	
NNB0612	3/16 X 3/4	500	
NNB0806	1/4 X 3/8	500	
NNB0807	1/4 X 7/16	500	
NNB0808	1/4 X 1/2	500	
NNB0809	1/4 X 9/16	500	
NNB0810	1/4 X 5/8	500	
NNB0812	1/4 X 3/4	500	

## FULL BRAZIER ALUMINUM RIVET

1100F SOFT - LB. COUNT

Line: 1021-01



PART NUMBER	SIZE	QTY/BX	LIST PRICE
JTD0604	3/16 X 1/4	25 LB.	
JTD0605	3/16 X 5/16	25 LB.	
JTD0606	3/16 X 3/8	25 LB.	
JTD0607	3/16 X 7/16	25 LB.	
JTD0608	3/16 X 1/2	25 LB.	
JTD0609	3/16 X 9/16	25 LB.	
JTD0610	3/16 X 5/8	25 LB.	
JTD0612	3/16 X 3/4	25 LB.	
JTD0804	1/4 X 1/4	25 LB.	
JTD0805	1/4 X 5/16	25 LB.	
JTD0806	1/4 X 3/8	25 LB.	
JTD0807	1/4 X 7/16	25 LB.	
JTD0808	1/4 X 1/2	25 LB.	
JTD0809	1/4 X 9/16	25 LB.	
JTD0810	1/4 X 5/8	25 LB.	
JTD0812	1/4 X 3/4	25 LB.	

## FULL BRAZIER ALUMINUM RIVET

2117T4 HARD - LB. COUNT

Line: 1022-02



PART NUMBER	SIZE	QTY/BX	LIST PRICE
JUD0604	3/16 X 1/4	25 LB.	
JUD0605	3/16 X 5/16	25 LB.	
JUD0606	3/16 X 3/8	25 LB.	
JUD0607	3/16 X 7/16	25 LB.	
JUD0608	3/16 X 1/2	25 LB.	
JUD0609	3/16 X 9/16	25 LB.	
JUD0610	3/16 X 5/8	25 LB.	
JUD0612	3/16 X 3/4	25 LB.	
JUD0614	3/16 X 7/8	25 LB.	
JUD0616	3/16 X 1	25 LB.	
JUD0620	3/16 X 1 1/4	25 LB.	
JUD0804	1/4 X 1/4	25 LB.	
JUD0805	1/4 X 5/16	25 LB.	
JUD0806	1/4 X 3/8	25 LB.	
JUD0807	1/4 X 7/16	25 LB.	
JUD0808	1/4 X 1/2	25 LB.	
JUD0809	1/4 X 9/16	25 LB.	
JUD0810	1/4 X 5/8	25 LB.	
JUD0812	1/4 X 3/4	25 LB.	
JUD0814	1/4 X 7/8	25 LB.	
JUD0816	1/4 X 1	25 LB.	
JUD0820	1/4 X 1 1/4	25 LB.	

## TRUSS HEAD NYLON TAP-IT RIVET

STEEL NAIL

Line: 1029-00

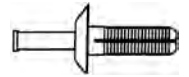

PART NUMBER	SIZE	QTY/BX	LIST PRICE
NXB0312	3/16 X 3/4	500	
NXB0316	3/16 X 1	500	
NXB0316RD	3/16 X 1 ROUND HEAD	100	
NXB0408	1/4 X 1/2	500	
NXB0412	1/4 X 3/4	500	
NXB0416	1/4 X 1	500	
NXB0424	1/4 X 1 1/2	500	
NXB0424C	1/4 X 1 1/2	100	
NXB0432	1/4 X 2	100	
NXB0448	1/4 X 3	100	
NXB0464	1/4 X 4	100	

## FLAT HEAD NYLON TAP-IT RIVET

STEEL NAIL

Line: 1030-00

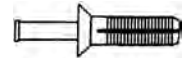

PART NUMBER	SIZE	QTY/BX	LIST PRICE
NYB0316	3/16 X 1	500	
NYB0324	3/16 X 1 1/2	250	
NYB0412	1/4 X 3/4	500	
NYB0416	1/4 X 1	500	
NYB0424	1/4 X 1 1/2	500	
NYB0432	1/4 X 2	100	

**UNIVERSAL HEAD PIN DRIVE**

ALUMINUM RIVET

Line: 1034-00

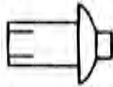

PART NUMBER	SIZE	QTY/BX	LIST PRICE
PCB66-02	1/8 X -2	1000	
PCB66-03	1/8 X -3	1000	
PCB66-04	1/8 X -4	1000	
PCB66-05	1/8 X -5	1000	
PCB66-06	1/8 X -6	1000	
PCB66-07	1/8 X -7	1000	
PCB66-08	1/8 X -8	1000	
PCB66-09	1/8 X -9	1000	
PCB66-10	1/8 X -10	1000	
PCB66-11	1/8 X -11	1000	
PCB66-12	1/8 X -12	1000	
PCB88-03	5/32 X -3	1000	
PCB88-04	5/32 X -4	1000	
PCB88-05	5/32 X -5	1000	
PCB88-06	5/32 X -6	1000	
PCB88-07	5/32 X -7	1000	
PCB88-08	5/32 X -8	1000	
PCB88-09	5/32 X -9	1000	
PCB88-10	5/32 X -10	1000	
PCB88-11	5/32 X -11	1000	
PCB03-02	3/16 X -2	1000	
PCB03-04	3/16 X -4	1000	
PCB03-06	3/16 X -6	1000	
PCB03-08	3/16 X -8	1000	
PCB03-10	3/16 X -10	1000	
PCB03-12	3/16 X -12	1000	
PCB03-14	3/16 X -14	1000	
PCB03-16	3/16 X -16	500	
PCB03-18	3/16 X -18	1000	
PCB03-20	3/16 X -20	500	
PCB03-28	3/16 X -28	500	
PCB03-32	3/16 X -32	500	
PCB04-02	1/4 X -2	1000	
PCB04-04	1/4 X -4	1000	
PCB04-06	1/4 X -6	500	
PCB04-08	1/4 X -8	500	
PCB04-10	1/4 X -10	500	
PCB04-12	1/4 X -12	500	
PCB04-14	1/4 X -14	500	
PCB04-16	1/4 X -16	500	
PCB04-18	1/4 X -18	500	
PCB04-20	1/4 X -20	500	
PCB04-24	1/4 X -24	500	
PCB05-06	5/16 X -6	200	

(continued...)

**UNIVERSAL HEAD PIN DRIVE (cont.)**

ALUMINUM RIVET

Line: 1034-00

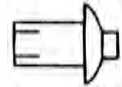

PART NUMBER	SIZE	QTY/BX	LIST PRICE
PCB05-09	5/16 X -09	200	
PCB05-12	5/16 X -12	200	
PCB05-15	5/16 X -15	200	
PCB05-18	5/16 X -18	200	
PCB05-21	5/16 X -21	200	
PCB06-06	3/8 X -6	200	
PCB06-09	3/8 X -09	200	
PCB06-12	3/8 X -12	200	
PCB06-15	3/8 X -15	100	
PCB06-18	3/8 X -18	100	
PCB06-21	3/8 X -21	100	



**CALL - 1 (800) 723-2826**

**CALL: (800) 723-2826**

## FULL BRAZIER HEAD PIN DRIVE

ALUMINUM RIVET

Line: 1036-00

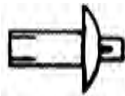

PART NUMBER	SIZE	QTY/BX	LIST PRICE
PEB66-03	1/8 X -3	1000	
PEB66-04	1/8 X -4	1000	
PEB66-05	1/8 X -5	1000	
PEB66-07	1/8 X -7	1000	
PEB03-02	3/16 X -2	500	
PEB03-04	3/16 X -4	500	
PEB03-06	3/16 X -6	500	
PEB03-08	3/16 X -8	500	
PEB03-10	3/16 X -10	500	
PEB03-12	3/16 X -12	500	
PEB03-14	3/16 X -14	500	
PEB03-16	3/16 X -16	500	
PEB03-18	3/16 X -18	500	
PEB03-20	3/16 X -20	500	
PEB03-26	3/16 X -26	500	
PEB03-32	3/16 X -32	500	
PEB04-02	1/4 X -2	500	
PEB04-04	1/4 X -4	500	
PEB04-06	1/4 X -6	500	
PEB04-08	1/4 X -8	500	
PEB04-10	1/4 X -10	500	
PEB04-12	1/4 X -12	500	
PEB04-14	1/4 X -14	500	
PEB04-16	1/4 X -16	500	
PEB04-20	1/4 X -20	250	
PEB04-24	1/4 X -24	500	
PEB04-28	1/4 X -28	500	
PEB04-30	1/4 X -30	500	
PEB04-32	1/4 X -32	500	
PEB04-36	1/4 X -36 EX LONG	200	
PEB04-44	1/4 X -44 EX LONG	200	

## 3G PIN DRIVE LINER HEAD RIVET

ALUMINUM RIVET

Line: 1040-00



PART NUMBER	SIZE	QTY/BX	LIST PRICE
PJB03-11	3/16 X -11	1000	
PJB03-12	3/16 X -12	500	
PJB03-13	3/16 X -13	500	
PJB03-14	3/16 X -14	500	
PJB03-15	3/16 X -15	500	
PJB03-16	3/16 X -16	500	
PJB03-17	3/16 X -17	500	
PJB03-18	3/16 X -18	500	
PJB03-19	3/16 X -19	500	

# SECTION 13 PRODUCT INDEX

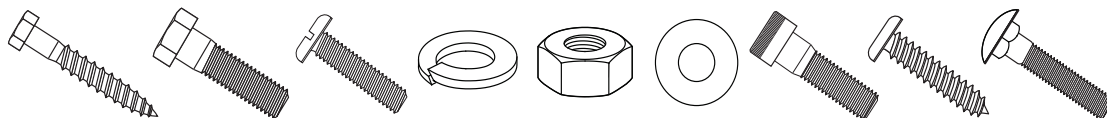

## NUTS

Line Description	Alpha	Line#	Page#
HEX MACHINE SCREW NUT UNC - 304 STAINLESS STEEL	VVU	1041-00	13-6
HEX MACHINE SCREW NUT UNF - 304 STAINLESS STEEL	VVS	1042-00	13-6
FINISHED HEX NUT UNC - 304 STAINLESS STEEL	SSU	1043-00	13-6
FINISHED HEX NUT UNF - 304 STAINLESS STEEL	SSS	1044-00	13-6
FINISHED HEX JAM NUT UNC - 304 STAINLESS STEEL	APU	1045-00	13-6
FINISHED HEX JAM NUT UNF - 304 STAINLESS STEEL	APS	1046-00	13-7
HEAVY HEX NUT UNC - 304 STAINLESS STEEL	DXC	1047-00	13-7
HEAVY HEX NUT JAM UNC - 304 STAINLESS STEEL	JLJ	1047-01	13-7
NYLON INSERT LOCK NUT MACHINE SCREW PATT UNC - 304 STAINLESS STEEL	BKU	1048-00	13-7
NYLON INSERT LOCK NUT MACHINE SCREW PATT UNF - 304 STAINLESS STEEL	BKS	1049-00	13-7
NYLON INSERT LOCK NUT JAM PATT UNC - 304 STAINLESS STEEL	BLU	1050-00	13-7
NYLON INSERT LOCK NUT JAM PATT UNF - 304 STAINLESS STEEL	BLS	1051-00	13-7
NYLON INSERT LOCK NUT FINISHED PATT UNC - 304 STAINLESS STEEL	BMU	1052-00	13-8
NYLON INSERT LOCK NUT FINISHED PATT UNF - 304 STAINLESS STEEL	BMS	1053-00	13-8
HEX FLANGE SERRATED NUT UNC - 304 STAINLESS STEEL	CBP	1053-10	13-8
FINISHED FLEX-LOC NUT UNC - STAINLESS STEEL	BVU	1054-00	13-8
FINISHED FLEX-LOC NUT UNF - STAINLESS STEEL	BVS	1055-00	13-8
FINISHED JAM FLEX-LOC NUT UNC - STAINLESS STEEL	BWU	1056-00	13-9
FINISHED JAM FLEX-LOC NUT UNF - STAINLESS STEEL	BWS	1057-00	13-9
HEAVY FLEX-LOC NUT UNC - STAINLESS STEEL	JRK	1057-01	13-9
HEAVY JAM FLEX-LOC NUT UNC - STAINLESS STEEL	JSK	1057-02	13-9
METRIC FINISHED FLEX-LOC NUT - STAINLESS STEEL	CER	1057-03	13-10
WING NUT FORGED UNC - 304 STAINLESS STEEL	BHU	1058-00	13-10
WING NUT FORGED UNF - 304 STAINLESS STEEL	BHS	1059-00	13-10
HEX CAP NUT UNC - 304 STAINLESS STEEL	BFU	1060-00	13-10
HEX CAP NUT UNF - 304 STAINLESS STEEL	BFS	1061-00	13-10
ROD COUPLING NUT UNC - 304 STAINLESS STEEL	JFD	1062-00	13-10
SQUARE MACHINE SC NUT - 304 STAINLESS STEEL	JWZ	1062-03	13-10
HEX MACHINE SC NUT UNC - 316 STAINLESS STEEL	XXU	1063-00	13-11
HEX MACHINE SC NUT UNF - 316 STAINLESS STEEL	XXS	1064-00	13-11
FINISHED HEX NUT UNC/UNF - 316 STAINLESS STEEL	TTU/TTS	1065-00	13-11
HEAVY HEX NUT UNC - 316 STAINLESS STEEL	DYC	1068-00	13-11
HEX MACHINE SCREW NUT UNC - BRASS	WWU	1069-00	13-11
HEX MACHINE SCREW NUT UNF - BRASS	WWS	1070-00	13-11
FINISHED HEX NUT UNC - BRASS	RRU	1071-00	13-12
HEAVY HEX NUT UNC - BRASS	DUD	1072-00	13-12
FINISHED HEX NUT UNF - BRASS	RRS	1073-00	13-12
FINISHED JAM NUT UNC - BRASS	ARU	1074-00	13-12
FINISHED JAM NUT UNF - BRASS	ARS	1075-00	13-12
MANIFOLD NUTS UNC - BRASS	JFY	1075-01	13-13

(CONTINUED...)

# SECTION 13 PRODUCT INDEX

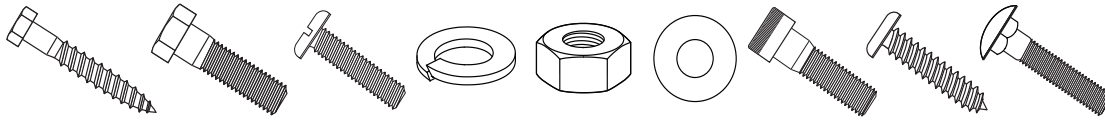

## NUTS (continued)

Line Description	Alpha	Line#	Page#
WING NUT FORGED UNC - BRASS	<b>BJU</b>	<b>1076-00</b>	<b>13-13</b>
WING NUT FORGED UNF - BRASS	<b>BJS</b>	<b>1077-00</b>	<b>13-13</b>
HEX CAP NUT UNC - BRASS	<b>BGU</b>	<b>1078-00</b>	<b>13-13</b>
HEX CAP NUT UNF - BRASS	<b>BGS</b>	<b>1079-00</b>	<b>13-13</b>
HEX CAP NUT UNC - BRASS NICKEL PLATED	<b>BZU</b>	<b>1080-00</b>	<b>13-13</b>
HEX CAP NUT UNF - BRASS NICKEL PLATED	<b>BZS</b>	<b>1081-00</b>	<b>13-13</b>
HEX MACHINE SCREW NUT UNC - SIL BRONZE	<b>UUU</b>	<b>1082-00</b>	<b>13-13</b>
HEX MACHINE SCREW NUT UNF - SIL BRONZE	<b>UUS</b>	<b>1083-00</b>	<b>13-13</b>
FINISHED HEX NUT UNC - BRONZE	<b>ANU</b>	<b>1084-00</b>	<b>13-14</b>
HEX MACHINE SCREW NUTS UNC - NYLON	<b>ZZU</b>	<b>1086-00</b>	<b>13-14</b>
HEX MACHINE SCREW NUTS UNF - NYLON	<b>ZZS</b>	<b>1087-00</b>	<b>13-14</b>
FINISHED HEX NUTS UNC - NYLON	<b>ABA</b>	<b>1088-00</b>	<b>13-14</b>
FINISHED HEX NUTS - ALUMINUM	<b>ACA</b>	<b>1089-00</b>	<b>13-14</b>
FINISHED HEX NUTS - TITANIUM T-5	<b>ACM</b>	<b>1089-01</b>	<b>13-14</b>

## WASHERS

Line Description	Alpha	Line#	Page#
USS FLAT WASHERS - 304 STAINLESS STEEL	<b>CDU</b>	<b>1090-00</b>	<b>13-14</b>
SAE FLAT WASHERS - 304 STAINLESS STEEL	<b>CDS</b>	<b>1091-00</b>	<b>13-15</b>
FENDER WASHERS - 304 STAINLESS STEEL	<b>ASJ</b>	<b>1091-10</b>	<b>13-15</b>
REGULAR SPLIT LOCK WASHERS - 304 STAINLESS STEEL	<b>BMA</b>	<b>1092-00</b>	<b>13-15</b>
HI-COLLAR SPLIT LOCK WASHERS - 304 STAINLESS STEEL	<b>JPJ</b>	<b>1092-01</b>	<b>13-15</b>
INTERNAL TOOTH LOCK WASHERS - STAINLESS STEEL	<b>BKA</b>	<b>1093-00</b>	<b>13-16</b>
EXTERNAL TOOTH LOCK WASHERS - STAINLESS STEEL	<b>BLA</b>	<b>1094-00</b>	<b>13-16</b>
FINISHING WASHERS - 304 STAINLESS STEEL	<b>BYA</b>	<b>1095-00</b>	<b>13-16</b>
USS FLAT WASHERS - 316 STAINLESS STEEL	<b>BNA</b>	<b>1096-00</b>	<b>13-16</b>
REGULAR SPLIT LOCK WASHERS - 316 STAINLESS STEEL	<b>BTA</b>	<b>1097-00</b>	<b>13-17</b>
SAE FLAT WASHERS - BRASS	<b>CEU</b>	<b>1098-00</b>	<b>13-17</b>
USS FLAT WASHERS - BRASS	<b>CES</b>	<b>1099-00</b>	<b>13-17</b>
FLAT WASHERS - SILICON BRONZE	<b>BRA</b>	<b>1100-00</b>	<b>13-17</b>
REGULAR SPLIT LOCK WASHERS - SILICON BRONZE	<b>BSA</b>	<b>1101-00</b>	<b>13-18</b>
FLAT WASHERS - NYLON	<b>BWA</b>	<b>1104-00</b>	<b>13-18</b>
FLAT WASHERS - ALUMINUM	<b>BVA</b>	<b>1105-00</b>	<b>13-18</b>
REGULAR SPLIT LOCK WASHERS - ALUMINUM	<b>BUA</b>	<b>1106-00</b>	<b>13-18</b>

# SECTION 13 PRODUCT INDEX

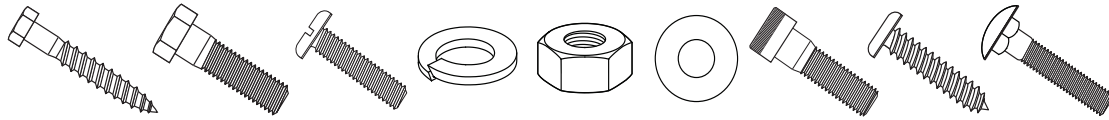

## CAP SCREWS & BOLTS

Line Description	Alpha	Line#	Page#
HEX HEAD CAP SCREWS UNC - 304 STAINLESS STEEL	AGU	1107-00	13-18
HEX HEAD CAP SCREWS UNF - 304 STAINLESS STEEL	ABS	1108-00	13-21
HEX HEAD CAP SCREWS UNC - 316 STAINLESS STEEL	CMA	1109-00	13-22
HEX HEAD CAP SCREWS UNC - BRASS	AHU	1110-00	13-24
HEX HEAD CAP SCREWS UNC - SILICON BRONZE	CNA	1112-00	13-25
HEX HEAD CAP SCREWS UNC - NYLON	CPA	1113-00	13-25
HEX HEAD CAP SCREWS UNC - ALUMINUM	JYE	1113-01	13-26
HEX HEAD LAG BOLTS - 304 STAINLESS STEEL	HWA	1115-00	13-26
CARRIAGE BOLTS - 304 STAINLESS STEEL	CXA	1116-00	13-27

## SCREWS

Line Description	Alpha	Line#	Page#
SLT ROUND MACHINE SCREWS - 304 STAINLESS STEEL	EBA	1117-00	13-28
SLT FLAT MACHINE SCREWS - 304 STAINLESS STEEL	ECA	1118-00	13-30
SLT TRUSS MACHINE SCREWS - 304 STAINLESS STEEL	EDA	1119-00	13-32
SLT PAN MACHINE SCREWS - 304 STAINLESS STEEL	EEA	1120-00	13-32
SLT HEX MACHINE SCREWS - 304 STAINLESS STEEL	EFA	1121-00	13-34
SLT OVAL MACHINE SCREWS - 304 STAINLESS STEEL	JVE	1121-01	13-34
SLT FILLISTER MACHINE SCREWS - 304 STAINLESS STEEL	JEF	1121-02	13-35
SLT ROUND MACHINE SCREWS - BRASS	EJA	1124-00	13-36
SLT FLAT MACHINE SCREWS - BRASS	EKA	1125-00	13-38
SLT BINDER MACHINE SCREWS - BRASS	ELA	1126-00	13-40
SLT FILLISTER MACHINE SCREWS - BRASS	EMA	1127-00	13-41
SLT ROUND MACHINE SCREWS - ALUMINUM	JZE	1127-01	13-42
SLT FLAT MACHINE SCREWS - ALUMINUM	JAF	1127-02	13-42
PHILLIPS FLAT MACHINE SCREWS - 304 STAINLESS STEEL	JJF	1127-03	13-42
PHILLIPS TRUSS MACHINE SCREWS - 304 STAINLESS STEEL	JKF	1127-04	13-44
PHILLIPS PAN MACHINE SCREWS - 304 STAINLESS STEEL	JLF	1127-05	13-44
PHILLIPS OVAL MACHINE SCREWS - 304 STAINLESS STEEL	JMF	1127-06	13-46
PHILLIPS ROUND MACHINE SCREWS - 304 STAINLESS STEEL	JRG	1127-07	13-47
SLT OVAL MACHINE SCREWS - BRASS	JDJ	1127-08	13-47
PHILLIPS FLAT MACHINE SCREWS - BRASS	JIJ	1127-09	13-47
SLOT ROUND MACHINE SCREWS - NYLON	JSJ	1127-15	13-47
SLOT HEX MACHINE SCREWS - NYLON	JYJ	1127-16	13-48
SLOT FLAT MACHINE SCREWS - NYLON	JAK	1127-17	13-48
SLOT PAN MACHINE SCREWS - NYLON	CCF	1127-18	13-48
SLOT PAN SHEET METAL SCREWS - 304 STAINLESS STEEL	FZA	1128-00	13-48
SLOT HEX WASH SHEET METAL SCREWS - 304 STAINLESS STEEL	JWJ	1128-01	13-49
SLOT FLAT SHEET METAL SCREWS - 304 STAINLESS STEEL	GAA	1129-00	13-49

(CONTINUED...)



# SECTION 13 PRODUCT INDEX

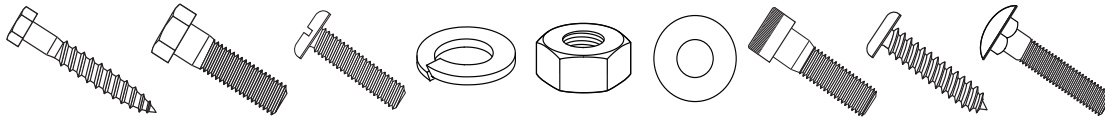

## SCREWS (continued)

Line Description	Alpha	Line#	Page#
SLOT ROUND SHEET METAL SCREWS - 304 STAINLESS STEEL	<b>GBA</b>	<b>1130-00</b>	<b>13-50</b>
SLOT TRUSS SHEET METAL SCREWS - 304 STAINLESS STEEL	<b>GCA</b>	<b>1131-00</b>	<b>13-50</b>
SLOT OVAL SHEET METAL SCREWS - 304 STAINLESS STEEL	<b>GDA</b>	<b>1132-00</b>	<b>13-51</b>
PHILLIPS PAN SHEET METAL SCREWS - 304 STAINLESS STEEL	<b>GEA</b>	<b>1133-00</b>	<b>13-51</b>
PHILLIPS FLAT SHEET METAL SCREWS - 304 STAINLESS STEEL	<b>GFA</b>	<b>1134-00</b>	<b>13-52</b>
PHILLIPS OVAL SHEET METAL SCREWS - 304 STAINLESS STEEL	<b>GGA</b>	<b>1135-00</b>	<b>13-53</b>
PHILLIPS TRUSS SHEET METAL SCREWS - 304 STAINLESS STEEL	<b>GHA</b>	<b>1136-00</b>	<b>13-54</b>
PHILLIPS ROUND SHEET METAL SCREWS - 304 STAINLESS STEEL	<b>GJA</b>	<b>1137-00</b>	<b>13-54</b>
SLOT PAN THRD CUT MACHINE SCREWS - 304 STAINLESS STEEL	<b>GKA</b>	<b>1138-00</b>	<b>13-54</b>
SLOT FLAT THRD CUT MACHINE SCREWS - 304 STAINLESS STEEL	<b>GLA</b>	<b>1139-00</b>	<b>13-55</b>
PHILLIPS PAN THRD CUT MACHINE SCREWS - 304 STAINLESS STEEL	<b>GRA</b>	<b>1140-00</b>	<b>13-55</b>
PHILLIPS FLAT THRD CUT MACHINE SCREWS - 304 STAINLESS STEEL	<b>GSA</b>	<b>1141-00</b>	<b>13-55</b>
SLOT FLAT WOOD SCREWS - 304 STAINLESS STEEL	<b>HNA</b>	<b>1146-00</b>	<b>13-55</b>
SLOT ROUND WOOD SCREWS - 304 STAINLESS STEEL	<b>JCF</b>	<b>1146-01</b>	<b>13-56</b>
SLOT OVAL WOOD SCREWS - 304 STAINLESS STEEL	<b>JDF</b>	<b>1146-02</b>	<b>13-56</b>
SLOT FLAT WOOD SCREWS - BRASS	<b>HJA</b>	<b>1147-00</b>	<b>13-56</b>
SLOT ROUND WOOD SCREWS - BRASS	<b>HKA</b>	<b>1148-00</b>	<b>13-58</b>
SLOT OVAL WOOD SCREWS - BRASS	<b>HLA</b>	<b>1149-00</b>	<b>13-59</b>
SLOT FLAT WOOD SCREWS - SILICON BRONZE	<b>HRA</b>	<b>1151-00</b>	<b>13-59</b>
PHILLIPS OVAL WOOD SCREWS - BRASS	<b>JVH</b>	<b>1153-01</b>	<b>13-59</b>
PHILLIPS FLAT WOOD SCREWS - BRASS	<b>ASL</b>	<b>1153-02</b>	<b>13-59</b>
PHILLIPS FLAT WOOD SCREWS - 304 STAINLESS STEEL	<b>BEF</b>	<b>1153-03</b>	<b>13-60</b>
PHILLIPS FLAT WOOD SCREWS - SILICON BRONZE	<b>CZB</b>	<b>1153-04</b>	<b>13-61</b>
THUMB SCREW TYPE P NO SHOULDER - 304 STAINLESS STEEL	<b>KHA</b>	<b>1154-00</b>	<b>13-61</b>
THUMB SCREW TYPE S SHOULDER - 304 STAINLESS STEEL	<b>ABL</b>	<b>1155-00</b>	<b>13-61</b>
SOCKET HD CAP SCREWS - 304 STAINLESS STEEL	<b>JAA</b>	<b>1156-00</b>	<b>13-62</b>
SOCKET HD CAP SCREWS - NYLON	<b>CGM</b>	<b>1156-02</b>	<b>13-63</b>
FLAT SOCKET CAP SCREWS - 304 STAINLESS STEEL	<b>JEA</b>	<b>1157-00</b>	<b>13-63</b>
BUTTON SOCKET CAP SCREWS - 304 STAINLESS STEEL	<b>JJA</b>	<b>1158-00</b>	<b>13-64</b>
SOCKET SET SCREW CUP POINT - 304 STAINLESS STEEL	<b>JPA</b>	<b>1159-00</b>	<b>13-65</b>
SOCKET SHOULDER SCREWS - 304 STAINLESS STEEL	<b>JFK</b>	<b>1160-02</b>	<b>13-67</b>
SQUARE HD SET SCREW CUP POINT - 304 STAINLESS STEEL	<b>KGA</b>	<b>1161-00</b>	<b>13-67</b>
SOCKET SET SCREW CUP POINT - BRASS	<b>JUH</b>	<b>1161-03</b>	<b>13-67</b>
SOCKET CAP SCREW CUP POINT - SILICON BRONZE	<b>JCJ</b>	<b>1161-04</b>	<b>13-67</b>
DOWEL PINS - 304 STAINLESS STEEL	<b>KSA</b>	<b>1162-00</b>	<b>13-68</b>
TENSION SPLIT PINS - STAINLESS STEEL	<b>KVA</b>	<b>1163-00</b>	<b>13-68</b>
COTTER PINS - STAINLESS STEEL	<b>LBA</b>	<b>1164-00</b>	<b>13-70</b>
COTTER PINS - BRASS	<b>LCA</b>	<b>1165-00</b>	<b>13-71</b>
THREADED ROD - 304 STAINLESS STEEL	<b>KYA</b>	<b>1166-00</b>	<b>13-71</b>
ROUND HEAD U-DRIVE SCREWS - 304 STAINLESS STEEL	<b>ZVB</b>	<b>1167-00</b>	<b>13-72</b>

CALL: (800) 723-2826

# SECTION 13 PRODUCT INDEX

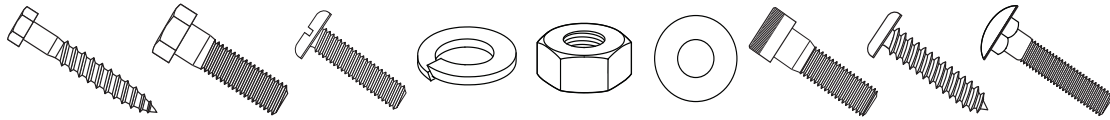

## THREADED ROD AND ROUND STOCK

Line Description	Alpha	Line#	Page#
THREADED ROD - 316 STAINLESS STEEL	LEA	1169-00	13-72
THREADED ROD - BRASS	KZA	1170-00	13-73
ROUND STOCK - BRASS	WCB	1171-00	13-74
THREADED ROD - ALUMINUM	LDA	1172-00	13-74



**CALL - 1 (800) 723-2826**

### HEX MACHINE SCREW NUT

304 STAINLESS STEEL - UNC

Line: 1041-00

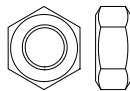

PART NUMBER	SIZE	QTY/BX	LIST PRICE
VVU00X	0/80	100	
VVU11X	1/64	100	
VVU22	2/56	100	
VVU33X	3/48	100	
VVU44	4/40	100	
VVU55	5/40	100	
VVU66	6/32	100	
VVU88	8/32	100	
VVU03	10/24	100	
VVU21	12/24	100	
VVU04	1/4-20	100	
VVU05X	5/16-18	100	

### HEX MACHINE SCREW NUT

304 STAINLESS STEEL - UNF

Line: 1042-00

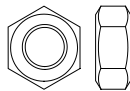

PART NUMBER	SIZE	QTY/BX	LIST PRICE
VVS11	1/72	100	
VVS33X	3/56	100	
VVS55X	5/44	100	
VVS66X	6/40	100	
VVS88X	8/36	100	
VVS03	10/32	100	
VVS04X	1/4-28	100	
VVS03SP	10/32 (5/16 WAF - 7/64 THICK)	100	

### FINISHED HEX NUT

304 STAINLESS STEEL - UNC

Line: 1043-00

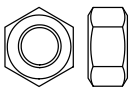

PART NUMBER	SIZE	QTY/BX	LIST PRICE
SSU04	1/4-20	100	
SSU05	5/16-18	100	
SSU06	3/8-16	100	
SSU07	7/16-14	100	
SSU08	1/2-13	100	
SSU09	9/16-12	50	
SSU10	5/8-11	50	
SSU12	3/4-10	25	
SSU14	7/8-9	10	
SSU16	1-8	10	
SSU18	1 1/8-7	10	

(continued...)

### FINISHED HEX NUT (cont.)

304 STAINLESS STEEL - UNC

Line: 1043-00

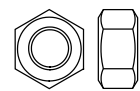

PART NUMBER	SIZE	QTY/BX	LIST PRICE
SSU20	1 1/4-7	10	
SSU24	1 1/2-6	5	
SSU28	1 3/4-5	5	

### FINISHED HEX NUT

304 STAINLESS STEEL - UNF

Line: 1044-00

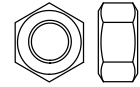

PART NUMBER	SIZE	QTY/BX	LIST PRICE
SSS04	1/4-28	100	
SSS05	5/16-24	100	
SSS06	3/8-24	100	
SSS07	7/16-20	100	
SSS08	1/2-20	100	
SSS09X	9/16-18	50	
SSS10	5/8-18	50	
SSS12	3/4-16	25	
SSS14	7/8-14	10	
SSS16	1-14	10	
SSS18	1 1/8-12	10	

### FINISHED HEX JAM NUT

304 STAINLESS STEEL - UNC

Line: 1045-00

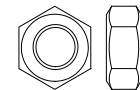

PART NUMBER	SIZE	QTY/BX	LIST PRICE
APU04	1/4-20	100	
APU05	5/16-18	100	
APU06	3/8-16	100	
APU07	7/16-14	100	
APU08	1/2-13	100	
APU10	5/8-11	50	
APU12	3/4-10	25	
APU14	7/8-9	10	
APU16	1-8	10	
APU18	1 1/8-7	10	
APU20	1 1/4-7	5	

## FINISHED HEX JAM NUT

304 STAINLESS STEEL - UNF

Line: 1046-00

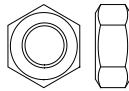

PART NUMBER	SIZE	QTY/BX	LIST PRICE
APS04	1/4-28	100	
APS05	5/16-24	100	
APS06	3/8-24	100	
APS07	7/16-20	100	
APS08	1/2-20	100	
APS10	5/8-18	50	
APS12	3/4-16	25	
APS14	7/8-14	10	
APSS16X	1-12	10	
APS16	1-14	10	

## HEAVY HEX NUT

304 STAINLESS STEEL

Line: 1047-00

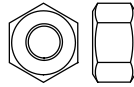

PART NUMBER	SIZE	QTY/BX	LIST PRICE
DXC04	1/4-20	100	
DXC05	5/16-18	100	
DXC06	3/8-16	100	
DXC07	7/16-14	100	
DXC08	1/2-13	100	
DXC09X	9/16-12	50	
DXC10	5/8-11	50	
DXC12	3/4-10	25	
DXC14	7/8-9	10	
DXC16	1-8	10	
DXC18	1 1/8-7	10	
DXC18UN8	1 1/8-8 UN8	5	
DXC20	1 1/4-7	10	
DXC20UN8	1 1/4-8 UN8	5	
DXC36X	2 1/4-4 1/2	1	

## HEAVY HEX JAM NUT

304 STAINLESS STEEL

Line: 1047-01



PART NUMBER	SIZE	QTY/BX	LIST PRICE
JLJ06X	3/8-16	100	
JLJS06X	3/8-24	100	
JLJ07X	7/16-14	100	
JLJ08X	1/2-13	100	
JLJ20X	1 1/4-7	10	

## MACHINE SCREW NYLON INSERT LOCKNUT

STAINLESS STEEL - UNC

Line: 1048-00

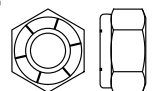

PART NUMBER	SIZE	QTY/BX	LIST PRICE
BKU44	4/40	100	
BKU66	6/32	100	
BKU88	8/32	100	
BKU03	10/24	100	

## MACHINE SCREW NYLON INSERT LOCKNUT

STAINLESS STEEL - UNF

Line: 1049-00

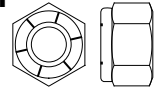

PART NUMBER	SIZE	QTY/BX	LIST PRICE
BKS03	10/32	100	

## FINISHED HEX JAM NYLON INSERT LOCKNUT

STAINLESS STEEL - UNC

Line: 1050-00

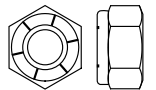

PART NUMBER	SIZE	QTY/BX	LIST PRICE
BLU04	1/4-20	100	
BLU05	5/16-18	100	
BLU06	3/8-16	100	
BLU07	7/16-14	100	
BLU08	1/2-13	100	
BLU10	5/8-11	50	
BLU12	3/4-10	25	

## FINISHED HEX JAM NYLON INSERT LOCKNUT

STAINLESS STEEL - UNF

Line: 1051-00

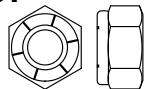

PART NUMBER	SIZE	QTY/BX	LIST PRICE
BLS04	1/4-28	100	
BLS05	5/16-24	100	
BLS06	3/8-24	100	
BLS07	7/16-20	100	
BLS08	1/2-20	100	
BLS10	5/8-18	50	
BLS12	3/4-16	25	

**FINISHED HEX NYLON INSERT LOCKNUT**

STAINLESS STEEL - UNC

Line: 1052-00

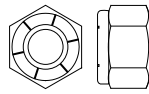

PART NUMBER	SIZE	QTY/BX	LIST PRICE
BMU21	12-24	100	
BMU04	1/4-20	100	
BMU05	5/16-18	100	
BMU06	3/8-16	100	
BMU07	7/16-14	100	
BMU08	1/2-13	100	
BMU10	5/8-11	50	
BMU12	3/4-10	25	
BMU14	7/8-9	10	
BMU16	1-8	10	

**FINISHED HEX NYLON INSERT LOCKNUT**

STAINLESS STEEL - UNF

Line: 1053-00

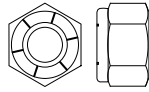

PART NUMBER	SIZE	QTY/BX	LIST PRICE
BMS04	1/4-28	100	
BMS05	5/16-24	100	
BMS06	3/8-24	100	
BMS07	7/16-20	100	
BMS08	1/2-20	100	
BMS10	5/8-18	50	
BMS12	3/4-16	25	

**HEX SERRATED FLANGE NUT**

STAINLESS STEEL - UNC & UNF

Line: 1053-10

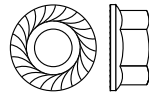

PART NUMBER	SIZE	QTY/BX	LIST PRICE
CBP88	8/32	100	
CBP03	10/24	100	
CBPS03	10/32	100	
CBP04	1/4-20	100	
CBPS04	1/4-28	100	
CBP05	5/16-18	100	
CBP06	3/8-16	100	

**FINISHED FLEXLOC NUT**

STAINLESS STEEL - UNC

Line: 1054-00

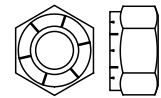

PART NUMBER	SIZE	QTY/BX	LIST PRICE
BVU50FA256	2/56	100	
BVU50FA256MC	2/56	5	
BVU50FA348	3/48	100	
BVU50FA440	4/40	100	
BVU50FA440MC	4/40	10	
BVU50FA632	6/32	100	
BVU50FA632MC	6/32	10	
BVU50FA832	8/32	100	
BVU50FA832MC	8/32	10	
BVU50FA1024	10/24	100	
BVU50FA1024MC	10/24	10	
BVU50FA420	1/4-20	100	
BVU50FA420MC	1/4-20	10	
BVU50FAF518	5/16-18	100	
BVU50FAF518MC	5/16-18	5	
BVU50FAF616	3/8-16	100	
BVU50FAF616MC	3/8-16	5	
BVU50FAF714	7/16-14	100	
BVU50FAF813	1/2-13	100	
BVU50FAF813MC	1/2-13	100	

**FINISHED FLEXLOC NUT**

STAINLESS STEEL - UNF

Line: 1055-00

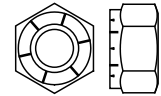

PART NUMBER	SIZE	QTY/BX	LIST PRICE
BVS50FC448	4/48	100	
BVS50FC544	5/44	100	
BVS50FC640	6/40	100	
BVS50FC836	8/36	100	
BVS50FC1032	10/32	100	
BVS50FC1032MC	10/32	10	
BVS50FC428	1/4-28	100	
BVS50FC428MC	1/4-28	10	
BVS50FC524	5/16-24	100	
BVS50FC524MC	5/16-24	5	
BVS50FC624	3/8-24	100	
BVS50FC624MC	3/8-24	5	
BVS50FC720	7/16-20	100	
BVS50FC720MC	7/16-20	100	
BVS50FC820	1/2-20	100	
BVS50FC820MC	1/2-20	100	

## FINISHED JAM FLEXLOC NUT

STAINLESS STEEL - UNC

Line: 1056-00

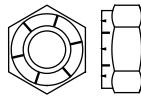

PART NUMBER	SIZE	QTY/BX	LIST PRICE
BWU50FK632	6/32	100	
BWU50FK632MC	6/32	10	
BWU50FK832	8/32	100	
BWU50FK832MC	8/32	10	
BWU50FK1024	10/24	100	
BWU50FK1024MC	10/24	10	
BWU50FK420	1/4-20	100	
BWU50FK420MC	1/4-20	10	
BWU50FKF518	5/16-18	100	
BWU50FKF518MC	5/16-18	5	
BWU50FKF616	3/8-16	100	
BWU50FKF616MC	3/8-16	5	
BWU50FKF714	7/16-14	100	
BWU50FKF813	1/2-13	100	
BWU50FKF813MC	1/2-13	100	

## FINISHED JAM FLEXLOC NUT

STAINLESS STEEL - UNF

Line: 1057-00

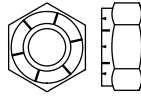

PART NUMBER	SIZE	QTY/BX	LIST PRICE
BWS50FK640	6/40	100	
BWS50FK836	8/36	100	
BWS50FK1032	10/32	100	
BWS50FK1032MC	10/32	10	
BWS50FK428	1/4-28	100	
BWS50FK428MC	1/4-28	5	
BWS50FK524	5/16-24	100	
BWS50FK524MC	5/16-24	5	
BWS50FK624	3/8-24	100	
BWS50FK624MC	3/8-24	5	
BWS50FK720	7/16-20	100	
BWS50FK820	1/2-20	100	
BWS50FK820MC	1/2-20	100	
BWS50FK918	9/16-18	50	
BWS50FK1018X	5/8-18	100	
BWS50FK1216	3/4-16	50	
BWS50FK1414X	7/8-14	25	

## HEAVY FLEXLOC NUT

STAINLESS STEEL - UNC

Line: 1057-01

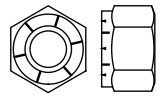

PART NUMBER	SIZE	QTY/BX	LIST PRICE
JRK50FAC420	1/4-20	100	
JRK50FAC420MC	1/4-20	10	
JRK50FA518	5/16-18	100	
JRK50FA518MC	5/16-18	5	
JRK50FA616	3/8-16	100	
JRK50FA616MC	3/8-16	100	
JRK50FA714	7/16-14	100	
JRK50FA714MC	7/16-14	100	
JRK50FA813	1/2-13	100	
JRK50FA813MC	1/2-13	100	
JRK50FA1011	5/8-11	50	
JRK50FA1210	3/4-10	50	
JRK50FA1409	7/8-9	25	
JRK50FA1608	1-8	25	

## HEAVY JAM FLEXLOC NUT

STAINLESS STEEL - UNC

Line: 1057-02

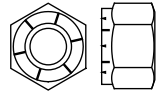

PART NUMBER	SIZE	QTY/BX	LIST PRICE
JSK50FKC420	1/4-20	100	
JSK50FKC420MC	1/4-20	100	
JSK50FK518	5/16-18	100	
JSK50FK518MC	5/16-18	100	
JSK50FK616	3/8-16	100	
JSK50FK616MC	3/8-16	100	
JSK50FK714	7/16-14	100	
JSK50FK813	1/2-13	100	
JSK50FK813MC	1/2-13	50	
JSK50FK1011	5/8-11	50	
JSK50FK1210	3/4-10	50	
JSK50FK1409	7/8-9	25	
JSK50FK1608	1-8	25	

**METRIC FLEXLOC NUT - FULL LIGHT HEX**

STAINLESS STEEL

Line: 1057-03

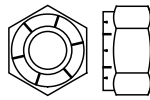

PART NUMBER	SIZE	QTY/BX	LIST PRICE
CER50MFAM3050	M3-0.5 (50MFAM3050)	100	
CER50MFAM407	M4-0.7 (50MFAM407)	100	
CER50MFAM508	M5-0.8 (50MFAM508)	100	
CER50MFAM610	M6-1.0 (50MFAM610)	100	
CER50MFA610MC	M6-1.0 (50MFAM610)	10	
CER50MFAM8125	M8-1.25 50MFAM8125	100	
CER50MFA812MC	M8-1.25 50MFAM8125	5	
CER50MFAM1015	M10-1.5 50MFAM1015	100	
CER50MFA101MC	M10-1.5 50MFAM1015	100	
CER50MFAM1217	M12-1.75 50MFAM1217	100	
CER50MFA121MC	M12-1.75 50MFAM1217	100	
CER50MFAM1420	M14-2.0 50MFAM1420	50	
CER50MFAM1620	M16-2.0 50MFAM1620	50	
CER50MFAM1825	M18-2.5 50MFAM1825	50	
CER50MFAM2025	M20-2.5 50MFAM2025	50	

**WING NUT - FORGED**

304 STAINLESS STEEL - UNC

Line: 1058-00

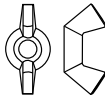

PART NUMBER	SIZE	QTY/BX	LIST PRICE
BHU66	6/32	100	
BHU88	8/32	100	
BHU03	10/24	100	
BHU04	1/4-20	100	
BHU05	5/16-18	100	
BHU06	3/8-16	100	
BHU08	1/2-13	25	
BHU10X	5/8-11	25	
BHU12	3/4-10	25	

**WING NUT - FORGED**

304 STAINLESS STEEL - UNF

Line: 1059-00

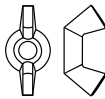

PART NUMBER	SIZE	QTY/BX	LIST PRICE
BHS03	10/32	100	

**HEX CAP NUT**

304 STAINLESS STEEL - UNC

Line: 1060-00

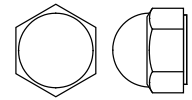

PART NUMBER	SIZE	QTY/BX	LIST PRICE
BFU66	6/32	100	
BFU88	8/32	100	
BFU03	10/24	100	
BFU04	1/4-20	100	
BFU05	5/16-18	100	
BFU06	3/8-16	100	
BFU07X	7/16-14	50	
BFU08	1/2-13	50	
BFU10	5/8-11	25	

**HEX CAP NUT**

304 STAINLESS STEEL - UNF

Line: 1061-00

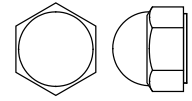

PART NUMBER	SIZE	QTY/BX	LIST PRICE
BFS03	10/32	100	
BFS08X	1/2-20	50	

**ROD COUPLING NUT**

304 STAINLESS STEEL

Line: 1062-00

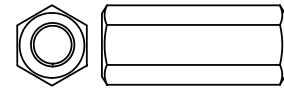

PART NUMBER	SIZE	QTY/BX	LIST PRICE
JFD04	1/4-20	50	
JFD05X	5/16-18	25	
JFD06X	3/8-16	25	
JFD07NF	7/16-20	25	
JFD08	1/2-13	25	
JFD08NF	1/2-20	25	
JFD10	5/8-11	25	
JFD12	3/4-10	25	
JFD16	1-8	10	

**SQUARE MACHINE SCREW NUT**

304 STAINLESS STEEL

Line: 1062-03

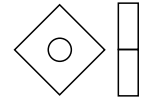

PART NUMBER	SIZE	QTY/BX	LIST PRICE
JWZS03	10/32	100	
JWZ04	1/4-20	100	

## HEX MACHINE SCREW NUT

316 STAINLESS STEEL - UNC

Line: 1063-00

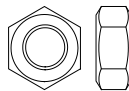

PART NUMBER	SIZE	QTY/BX	LIST PRICE
XXU44	4/40	100	
XXU66	6/32	100	
XXU88	8/32	100	
XXU03	10/24	100	

## HEX MACHINE SCREW NUT

316 STAINLESS STEEL - UNF

Line: 1064-00

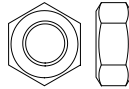

PART NUMBER	SIZE	QTY/BX	LIST PRICE
XXS03	10/32	100	

## FINISHED HEX NUT

316 STAINLESS STEEL - UNC/UNF

Line: 1065-00

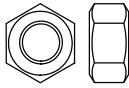

PART NUMBER	SIZE	QTY/BX	LIST PRICE
TTU04	1/4-20	100	
TTU05	5/16-18	100	
TTU06	3/8-16	100	
TTU06X	3/8-24	100	
TTU07	7/16-14	100	
TTU08	1/2-13	100	
TTS08X	1/2-20 (UNF)	100	
TTU09X	9/16-12	50	
TTU10	5/8-11	50	
TTU10X	5/8-18	50	
TTU12	3/4-10	25	
TTU12X	3/4-16	25	
TTU14	7/8-9	10	
TTU16	1-8	10	
TTS16	1-14 (UNF)	10	
TTU18	1 1/8-7	10	
TTU20	1 1/4-7	10	
TTU24	1 1/2-6	1	

## HEAVY HEX NUT

316 STAINLESS STEEL - UNC

Line: 1068-00



PART NUMBER	SIZE	QTY/BX	LIST PRICE
DYC04	1/4-20	100	
DYC05	5/16-18	100	
DYC06	3/8-16	100	
DYC07	7/16-14	100	
DYC08	1/2-13	100	

(continued...)

## HEAVY HEX NUT (cont.)

316 STAINLESS STEEL - UNC

Line: 1068-00



PART NUMBER	SIZE	QTY/BX	LIST PRICE
DYC10	5/8-11	50	
DYC12	3/4-10	25	
DYC14	7/8-9	25	
DYC16	1-8	25	
DYC18	1 1/8-7	10	
DYC18UN8	1 1/8-8 (UN8)	5	
DYC20	1 1/4-7	10	
DYC20UN8	1 1/4-8 (UN8)	5	
DYC24	1 1/2-6	10	
DYC28	1 3/4-5	1	
DYC32	2-4 1/2	1	

## HEX MACHINE SCREW NUT

BRASS - UNC

Line: 1069-00

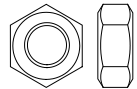

PART NUMBER	SIZE	QTY/BX	LIST PRICE
WWU00	0/80	100	
WWU11	1/72	100	
WWU22	2/56	100	
WWU33	3/48	100	
WWUC44X	4/36	100	
WWU44	4/40	100	
WWU55	5/40	100	
WWU66	6/32	100	
WWU88	8/32	100	
WWU03	10/24	100	
WWU21	12/24	100	
WWU04	1/4-20	100	
WWU05	5/16-18	100	
WWU06	3/8-16	100	

## HEX MACHINE SCREW NUT

BRASS - UNF

Line: 1070-00

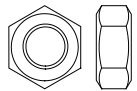

PART NUMBER	SIZE	QTY/BX	LIST PRICE
WWS33	3/56	100	
WWS44	4/48	100	
WWS66	6/40	100	
WWS03	10/32	100	
WWS21	12/28	100	
WWS04	1/4-28	100	



**FINISHED HEX NUT**

BRASS - UNC  
Line: 1071-00

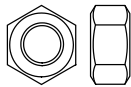

PART NUMBER	SIZE	QTY/BX	LIST PRICE
RRU04	1/4-20	100	
RRU05	5/16-18	100	
RRU06	3/8-16	100	
RRU07	7/16-14	100	
RRU08	1/2-13	100	
RRU10	5/8-11	50	
RRU12	3/4-10	50	
RRU14	7/8-9	25	
RRU16	1-8	10	
RRU18	1 1/8-7	10	
RRU24X	1 1/2-6	5	

**HEAVY HEX NUT**

BRASS  
Line: 1072-00

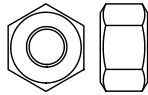

PART NUMBER	SIZE	QTY/BX	LIST PRICE
DUD04	1/4-20	100	
DUD05	5/16-18	100	
DUD06	3/8-16	100	
DUD07	7/16-14	100	
DUD08	1/2-13	100	
DUD09X	9/16-12	50	
DUD10	5/8-11	50	
DUD12	3/4-10	25	
DUD14	7/8-9	10	
DUD16	1-8	10	
DUD18	1 1/8-7	10	
DUD20	1 1/4-7	10	
DUD24	1 1/2-6	5	

**FINISHED HEX NUT**

BRASS  
Line: 1073-00

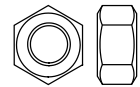

PART NUMBER	SIZE	QTY/BX	LIST PRICE
RRS04	1/4-28	100	
RRS05	5/16-24	100	
RRS06	3/8-24	100	
RRS07	7/16-20	100	
RRS08	1/2-20	100	
RRS10	5/8-18	50	
RRS12	3/4-16	50	
RRS14	7/8-14	10	
RRS16	1-14	10	
RRS24	1 1/2-12	5	

**FINISHED HEX JAM NUT**

BRASS - UNC  
Line: 1074-00

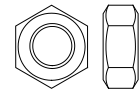

PART NUMBER	SIZE	QTY/BX	LIST PRICE
ARU04X	1/4-20	100	
ARU06	3/8-16	100	
ARU07	7/16-14	100	
ARU08	1/2-13	100	
ARU10	5/8-11	50	
ARU12	3/4-10	25	
ARU14	7/8-9	10	
ARU16	1-8	10	

**FINISHED HEX JAM NUT**

BRASS - UNF  
Line: 1075-00

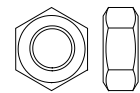

PART NUMBER	SIZE	QTY/BX	LIST PRICE
ARS04HVV	1/4-28 (HEAVY)	100	
ARS05X	5/16-24	100	
ARS06	3/8-24	100	
ARS07	7/16-20	100	
ARS08	1/2-20	100	
ARS10	5/8-18	50	
ARS12	3/4-16	25	
ARS14	7/8-14	10	
ARS16	1-14	10	

## MANIFOLD NUT

BRASS

Line: 1075-01



PART NUMBER	SIZE	QTY/BX	LIST PRICE
JFY06U	3/8-16	50	
JFY05	5/16-18	50	
JFY07	7/16-14	50	

## WING NUT - FORGED

BRASS - UNC

Line: 1076-00

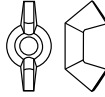

PART NUMBER	SIZE	QTY/BX	LIST PRICE
BJU66	6/32	100	
BJU88	8/32	100	
BJU03	10/24	100	
BJU04	1/4-20	100	
BJU05	5/16-18	100	
BJU06	3/8-16	50	
BJU08	1/2-13	25	

## WING NUT - FORGED

BRASS - UNF

Line: 1077-00

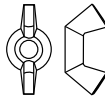

PART NUMBER	SIZE	QTY/BX	LIST PRICE
BJS03	10/32	100	

## HEX CAP NUT

BRASS - UNC

Line: 1078-00

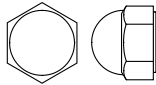

PART NUMBER	SIZE	QTY/BX	LIST PRICE
BGU33X	3/48	100	
BGU66	6/32	100	
BGU88	8/32	100	
BGU03	10/24	100	
BGU04	1/4-20	100	
BGU05	5/16-18	100	
BGU06	3/8-16	100	
BGU07	7/16-14	100	
BGU08	1/2-13	50	

## HEX CAP NUT

BRASS - UNF

Line: 1079-00

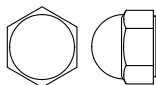

PART NUMBER	SIZE	QTY/BX	LIST PRICE
BGS03	10/32	100	
BGS08X	1/2-20	50	

## HEX CAP NUT

BRASS, NICKEL PLATED - UNC

Line: 1080-00

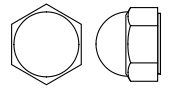

PART NUMBER	SIZE	QTY/BX	LIST PRICE
BZU66	6/32	100	
BZU88	8/32	100	
BZU03	10/24	100	
BZU04	1/4-20	100	
BZU05	5/16-18	100	
BZU06	3/8-16	100	
BZU08	1/2-13	50	

## HEX CAP NUT

BRASS, NICKEL PLATED - UNF

Line: 1081-00

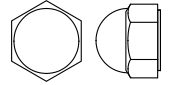

PART NUMBER	SIZE	QTY/BX	LIST PRICE
BZS03	10/32	100	

## HEX MACHINE SCREW NUT

SILICON BRONZE - UNC

Line: 1082-00

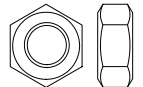

PART NUMBER	SIZE	QTY/BX	LIST PRICE
UUU66	6/32	100	
UUU88	8/32	100	
UUU03	10/24	100	
UUU21	12/24	100	
UUU04	1/4-20	100	
UUU05	5/16-18	100	
UUU06	3/8-16	100	

## HEX MACHINE SCREW NUT

SILICON BRONZE - UNF

Line: 1083-00



PART NUMBER	SIZE	QTY/BX	LIST PRICE
UUS03	10/32	100	

**FINISHED HEX NUT**

SILICON BRONZE - UNC

Line: 1084-00

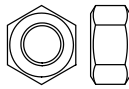

PART NUMBER	SIZE	QTY/BX	LIST PRICE
ANU04	1/4-20	100	
ANU05	5/16-18	100	
ANU05HVY	5/16-18 (HEAVY)	100	
ANU06	3/8-16	100	
ANU07	7/16-14	100	
ANU08	1/2-13	100	
ANU10	5/8-11	50	
ANU12	3/4-10	25	
ANU14	7/8-9	25	
ANU16	1-8	25	

**HEX MACHINE SCREW NUT**

NYLON - UNC

Line: 1086-00

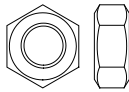

PART NUMBER	SIZE	QTY/BX	LIST PRICE
ZZU44	4/40	100	
ZZU66	6/32	100	
ZZU88	8/32	100	
ZZU03	10/24	100	

**HEX MACHINE SCREW NUT**

NYLON - UNF

Line: 1087-00

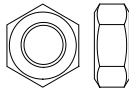

PART NUMBER	SIZE	QTY/BX	LIST PRICE
ZZS03	10/32	100	

**FINISHED HEX NUT**

NYLON - UNC

Line: 1088-00

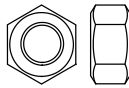

PART NUMBER	SIZE	QTY/BX	LIST PRICE
ABA04	1/4-20	100	
ABA05	5/16-18	100	
ABA06	3/8-16	100	
ABA08	1/2-13	100	
ABA10	5/8-11	25	

**FINISHED HEX NUT**

ALUMINUM

Line: 1089-00

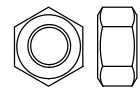

PART NUMBER	SIZE	QTY/BX	LIST PRICE
ACA04	1/4-20	100	
ACA05	5/16-18	100	
ACA06	3/8-16	100	
ACA08	1/2-13	50	
ACA10	5/8-11	50	
ACA12	3/4-10	25	

**FINISHED HEX NUT**

TITANIUM T5

Line: 1089-01

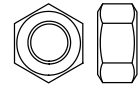

PART NUMBER	SIZE	QTY/BX	LIST PRICE
ACM12HVY	3/4-10	25	

**USS FLAT WASHER**

304 STAINLESS STEEL

Line: 1090-00

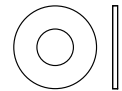

PART NUMBER	SIZE	QTY/BX	LIST PRICE
CDU03	#10 (9/16 OD)	100	
CDU21	#12	100	
CDU04	1/4 (5/8 OD)	100	
CDU05	5/16 (3/4 OD)	100	
CDU05THK	5/16 (.064-.104)	100	
CDU05X	5/16 (7/8 OD)	100	
CDU06	3/8 (7/8 OD)	100	
CDU06LXTHK	3/8 X (10D X 1/8THK)	100	
CDU07	7/16 (1 1/8 OD)	100	
CDU08	1/2 (1 1/4 OD)	100	
CDU08L	1/2 X 1 3/8 (OD MS819)	100	
CDU09	9/16 (1 3/8 OD)	50	
CDU10	5/8 (1 1/2 OD)	50	
CDU12	3/4 (1 3/4 OD)	50	
CDU14	7/8 (2 OD)	25	
CDU16	1 (2 1/2 OD)	25	
CDU18	1 1/8	25	
CDU20	1 1/4	25	
CDU24X	1 1/2	10	
CDU32	2"	10	

## SAE FLAT WASHER

304 STAINLESS STEEL

Line: 1091-00

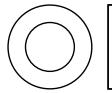

PART NUMBER	SIZE	QTY/BX	LIST PRICE
CDS22	#2	100	
CDS33X	#3	100	
CDS44	#4 (5/16 OD)MS-804	100	
CDS55	#5	100	
CDS66	#6 (3/8 OD) MS-806	100	
CDS88	#8 (7/16 OD)MS-841	100	
CDS03	#10 (7/16OD)AN-C10L	100	
CDS04	1/4 (1/2OD)AN-C416L	100	
CDS04X	1/4 X 9/16 SAE FLT W	100	
CDS05	5/16(11/16OD)MS-812	100	
CDS05LDX	5/16 X 9/16OD X.055	500	
CDS06	3/8 (.812OD)MS-814	100	
CDS07	7/16 (.921OD)MS-816	100	
CDS08	1/2 (1.062OD)MS-818	100	
CDS0812X	1/2 X 3/4 X 1/16	100	
CDS09	9/16 (1.062 OD)	50	
CDS10	5/8 (1.312OD)MS-820	50	
CDS12	3/4 (1.50 OD)MS-822	50	
CDS14	7/8 (1.75 OD)	25	
CDS14SX	7/8 X 1 X 1/16 ST/ST	25	
CDS16X	1" (2" OD)	25	

## FENDER WASHER

304 STAINLESS STEEL

Line: 1091-10

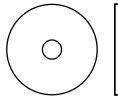

PART NUMBER	SIZE	QTY/BX	LIST PRICE
ASJ88	#8 (5/32) X 3/4 OD	100	
ASJ03	#10 X 1 OD	100	
ASJ04032	1/4 X 1 OD	100	
ASJ04	1/4 X 1 1/4 OD	100	
ASJ04048	1/4 X 1 1/2	100	
ASJ05040	5/16 X 1 1/4 OD	100	
ASJ05	5/16 X 1 1/2 OD	100	
ASJ06040	3/8 X 1 1/4 OD	100	
ASJ06	3/8 X 1 1/2 OD	100	
ASJ08	1/2 X 2 OD	100	
ASJ08THK	1/2 X 2 OD .125 THK	50	

## REGULAR SPLIT LOCKWASHER

304 STAINLESS STEEL

Line: 1092-00



PART NUMBER	SIZE	QTY/BX	LIST PRICE
BMA22	#2	100	
BMA44	#4	100	
BMA55	#5	100	
BMA66	#6	100	
BMA88	#8	100	
BMA03	#10	100	
BMA21X	#12	100	
BMA04	1/4	100	
BMA05	5/16	100	
BMA06	3/8	100	
BMA07	7/16	100	
BMA08	1/2	100	
BMA09X	9/16	50	
BMA10	5/8	50	
BMA12	3/4	25	
BMA14	7/8	25	
BMA16	1	25	
BMA18	1 1/8	25	
BMA20	1 1/4	25	

## HI-COLLAR LOCKWASHER

304 STAINLESS STEEL

Line: 1092-01



PART NUMBER	SIZE	QTY/BX	LIST PRICE
JPJ03X	#10	100	
JPJ04X	1/4	100	
JPJ05	5/16	100	
JPJ06X	3/8	100	
JPJ08X	1/2	100	
JPJ10	5/8	50	

### INTERNAL LOCKWASHER

STAINLESS STEEL

Line: 1093-00



PART NUMBER	SIZE	QTY/BX	LIST PRICE
BAK33X	#3	100	
BAK44	#4	100	
BAK55	#5	100	
BAK66	#6	100	
BAK88	#8	100	
BAK03	#10	100	
BAK21	#12	100	
BAK04	1/4	100	
BAK05	5/16	100	
BAK06	3/8	100	
BAK07	7/16	100	
BAK08	1/2	100	
BAK10X	5/8	50	
BAK12X	3/4	50	
BAK16	1	25	

### EXTERNAL LOCKWASHER

STAINLESS STEEL

Line: 1094-00

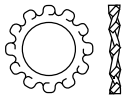

PART NUMBER	SIZE	QTY/BX	LIST PRICE
BLA22X	#2	100	
BLA44	#4	100	
BLA55	#5	100	
BLA66	#6	100	
BLA88	#8	100	
BLA03	#10	100	
BLA04	1/4	100	
BLA05	5/16	100	
BLA06	3/8	100	
BLA07	7/16	100	
BLA08	1/2	100	
BLA10X	5/8	50	
BLA12X	3/4	50	

### FINISHING WASHER

304 STAINLESS STEEL

Line: 1095-00



PART NUMBER	SIZE	QTY/BX	LIST PRICE
BYA66	#6	100	
BYA88	#8	100	
BYA03	#10	100	
BYA03BLK	#10 (BLACK FINISH)	100	
BYA21X	#12	100	
BYA04	#14	100	
BYA05	5/16	100	

### USS FLAT WASHER

316 STAINLESS STEEL

Line: 1096-00

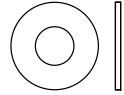

PART NUMBER	SIZE	QTY/BX	LIST PRICE
BNA66	#6	100	
BNA88	#8	100	
BNA03	#10	100	
BNA04	1/4 (5/8 OD)	100	
BNA05	5/16 (3/4 OD)	100	
BNA06	3/8 (7/8 OD)	100	
BNA07	7/16	100	
BNA08	1/2	100	
BNA09	9/16	50	
BNA10	5/8	50	
BNA12	3/4	50	
BNA14	7/8	25	
BNA16	1	25	
BNA18	1 1/8	25	
BNA20	1 1/4	10	
BNA24	1 1/2	10	



**CALL - 1 (800) 723-2826**

## REGULAR SPLIT LOCKWASHER

316 STAINLESS STEEL

Line: 1097-00

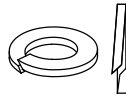

PART NUMBER	SIZE	QTY/BX	LIST PRICE
BTA66	#6	100	
BTA88	#8	100	
BTA03	#10	100	
BTA04	1/4	100	
BTA05	5/16	100	
BTA06	3/8	100	
BTA07	7/16	100	
BTA08	1/2	100	
BTA10	5/8	50	
BTA12	3/4	25	
BTA14	7/8	25	
BTA16	1	25	
BTA18	1 1/8	25	
BTA20X	1 1/4	10	

## SAE FLAT WASHER

BRASS

Line: 1098-00

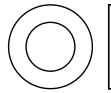

PART NUMBER	SIZE	QTY/BX	LIST PRICE
CEU22	#2	100	
CEU33	#3	100	
CEU44	#4	100	
CEU55	#5	100	
CEU66	#6 (.312 OD)	100	
CEU88	#8 (.375 OD)	100	
CEU03	#10 (.437 OD)	100	
CEU21	#12 (.500 OD)	100	
CEU04	1/4 (.562 OD)	100	
CEU05	5/16 (.750 OD)	100	
CEU06	3/8 (.875 OD)	100	
CEU07	7/16	100	
CEU08	1/2 (1 1/4 OD)	100	
CEU10	5/8 (1 1/2 OD)	50	
CEU12	3/4 (1 7/8 OD)	50	

## USS FLAT WASHER

BRASS

Line: 1099-00



PART NUMBER	SIZE	QTY/BX	LIST PRICE
CES04L#1	#16 .2821D X 3/4 OD	1	
CES20L#1	.337 X 7/8 OD	1	
CES24	1 1/2	1	
CES66	#6 (.375 OD)	100	
CES88	#8 (.437 OD)	100	
CES03	#10 (.500 OD)	100	
CES03#1	#10	1	
CES21	#12 (.562 OD)	100	
CES04	1/4 (.687 OD)	100	
CES05	5/16 (.875 OD)	100	
CES06	3/8 (1 OD)	100	
CES07	7/16	100	
CES08	1/2 (1 3/8 OD)	100	
CES10	5/8 (1 3/4 OD)	50	
CES12	3/4 (2 OD)	50	
CES14	7/8	25	
CES16	1	25	

## FLAT WASHER

SILICON BRONZE

Line: 1100-00

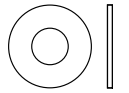

PART NUMBER	SIZE	QTY/BX	LIST PRICE
BRA66	#6	100	
BRA88	#8	100	
BRA03	#10	100	
BRA21	#12	100	
BRA04	1/4	100	
BRA05	5/16	100	
BRA06	3/8	100	
BRA07	7/16	100	
BRA08	1/2	100	
BRA10	5/8	50	
BRA12	3/4	50	

**REGULAR SPLIT LOCKWASHER**

SILICON BRONZE

Line: 1101-00



PART NUMBER	SIZE	QTY/BX	LIST PRICE
BSA44	#4	100	
BSA66	#6	100	
BSA88	#8	100	
BSA03	#10	100	
BSA21X	#12	100	
BSA04	1/4	100	
BSA05	5/16	100	
BSA06	3/8	100	
BSA07	7/16	100	
BSA08	1/2	100	
BSA10	5/8	50	
BSA12	3/4	50	

**FLAT WASHER**

NYLON

Line: 1104-00

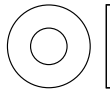

PART NUMBER	SIZE	QTY/BX	LIST PRICE
BWA66	#6	100	
BWA88	#8	100	
BWA03	#10	100	
BWA21	#12	100	
BWA04	1/4	100	
BWA04036	1/4 X 1 1/8 OD/.035TH	100	
BWA05	5/16	100	
BWA06	3/8	100	
BWA06028THK	3/8 X 7/8 X 3/8	100	
BWA08	1/2 X 1 3/8 X 1/8	100	
BWA08024	1/2 X 3/4 X 1/16	100	

**FLAT WASHER**

ALUMINUM

Line: 1105-00

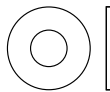

PART NUMBER	SIZE	QTY/BX	LIST PRICE
BVA66	#6	100	
BVA88	#8	100	
BVA03	#10	100	
BVA04	1/4	100	
BVA05	5/16	100	
BVA06	3/8	100	
BVA08	1/2	100	
BVA10	5/8	50	
BVA12	3/4	25	

**REGULAR SPLIT LOCKWASHER**

ALUMINUM

Line: 1106-00



PART NUMBER	SIZE	QTY/BX	LIST PRICE
BUA03	#10	100	
BUA04	1/4	100	
BUA05	5/16	100	
BUA06	3/8	100	
BUA08	1/2	100	
BUA10	5/8	50	

**HEX HEAD CAP SCREW**

304 STAINLESS STEEL - UNC

Line: 1107-00

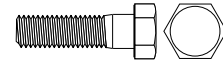

PART NUMBER	SIZE	QTY/BX	LIST PRICE
AGU04016	1/4-20 X 1/2	100	
AGU04020	1/4-20 X 5/8	100	
AGU04024	1/4-20 X 3/4	100	
AGU04028	1/4-20 X 7/8	100	
AGU04032	1/4-20 X 1	100	
AGU04040	1/4-20 X 1 1/4	100	
AGU04048	1/4-20 X 1 1/2	100	
AGU04056	1/4-20 X 1 3/4	100	
AGU04064	1/4-20 X 2	100	
AGU04072	1/4-20 X 2 1/4	50	
AGU04080	1/4-20 X 2 1/2	50	
AGU04088	1/4-20 X 2 3/4	50	
AGU04096	1/4-20 X 3	50	
AGU04104	1/4-20 X 3 1/4	50	
AGU04112	1/4-20 X 3 1/2	50	
AGU04120	1/4-20 X 3 3/4	50	
AGU04128	1/4-20 X 4	50	
AGU04144	1/4-20 X 4 1/2	25	
AGU04160	1/4-20 X 5	25	
AGU04176	1/4-20 X 5 1/2	25	
AGU04192	1/4-20 X 6	25	
AGU05012X	5/16-18 X 3/8	100	
AGU05016	5/16-18 X 1/2	100	
AGU05020	5/16-18 X 5/8	100	
AGU05024	5/16-18 X 3/4	100	
AGU05028	5/16-18 X 7/8	100	
AGU05032	5/16-18 X 1	100	
AGU05040	5/16-18 X 1 1/4	100	
AGU05048	5/16-18 X 1 1/2	100	

(continued...)

## HEX HEAD CAP SCREW (cont.)

304 STAINLESS STEEL - UNC

Line: 1107-00

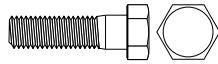

PART NUMBER	SIZE	QTY/BX	LIST PRICE
AGU05056	5/16-18 X 1 3/4	100	
AGU05064	5/16-18 X 2	100	
AGU05072	5/16-18 X 2 1/4	50	
AGU05080	5/16-18 X 2 1/2	50	
AGU05088	5/16-18 X 2 3/4	50	
AGU05096	5/16-18 X 3	50	
AGU05104	5/16-18 X 3 1/4	25	
AGU05112	5/16-18 X 3 1/2	25	
AGU05120	5/16-18 X 3 3/4	25	
AGU05128	5/16-18 X 4	25	
AGU05144	5/16-18 X 4 1/2	25	
AGU05160	5/16-18 X 5	25	
AGU05176	5/16-18 X 5 1/2	25	
AGU05192	5/16-18 X 6	25	
AGU06016	3/8-16 X 1/2	100	
AGU06020	3/8-16 X 5/8	100	
AGU06024	3/8-16 X 3/4	100	
AGU06028	3/8-16 X 7/8	100	
AGU06032	3/8-16 X 1	100	
AGU06040	3/8-16 X 1 1/4	100	
AGU06048	3/8-16 X 1 1/2	100	
AGU06056	3/8-16 X 1 3/4	50	
AGU06064	3/8-16 X 2	50	
AGU06072	3/8-16 X 2 1/4	50	
AGU06080	3/8-16 X 2 1/2	50	
AGU06088	3/8-16 X 2 3/4	50	
AGU06096	3/8-16 X 3	50	
AGU06104	3/8-16 X 3 1/4	25	
AGU06112	3/8-16 X 3 1/2	25	
AGU06120	3/8-16 X 3 3/4	25	
AGU06128	3/8-16 X 4	25	
AGU06144	3/8-16 X 4 1/2	25	
AGU06160	3/8-16 X 5	25	
AGU06176	3/8-16 X 5 1/2	25	
AGU06192	3/8-16 X 6	25	
AGU06208	3/8-16 X 6 1/2	25	
AGU06224	3/8-16 X 7	25	
AGU06256	3/8-16 X 8	25	
AGU06320	3/8-16 X 10	25	

(continued...)

## HEX HEAD CAP SCREW (cont.)

304 STAINLESS STEEL - UNC

Line: 1107-00

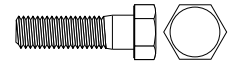

PART NUMBER	SIZE	QTY/BX	LIST PRICE
AGU07024	7/16-14 X 3/4	50	
AGU07032	7/16-14 X 1	50	
AGU07040	7/16-14 X 1 1/4	50	
AGU07048	7/16-14 X 1 1/2	50	
AGU07056	7/16-14 X 1 3/4	50	
AGU07064	7/16-14 X 2	50	
AGU07072	7/16-14 X 2 1/4	25	
AGU07080	7/16-14 X 2 1/2	25	
AGU07088	7/16-14 X 2 3/4	25	
AGU07096	7/16-14 X 3	25	
AGU07112	7/16-14 X 3 1/2	25	
AGU07128	7/16-14 X 4	25	
AGU07144	7/16-14 X 4 1/2	25	
AGU07160	7/16-14 X 5	25	
AGU07192	7/16-14 X 6	25	
AGU08016	1/2-13 X 1/2	50	
AGU08020	1/2-13 X 5/8	50	
AGU08024	1/2-13 X 3/4	50	
AGU08028	1/2-13 X 7/8	50	
AGU08032	1/2-13 X 1	50	
AGU08036	1/2-13 X 1 1/8	50	
AGU08040	1/2-13 X 1 1/4	50	
AGU08048	1/2-13 X 1 1/2	50	
AGU08056	1/2-13 X 1 3/4	50	
AGU08064	1/2-13 X 2	50	
AGU08072	1/2-13 X 2 1/4	25	
AGU08080	1/2-13 X 2 1/2	25	
AGU08088	1/2-13 X 2 3/4	25	
AGU08096	1/2-13 X 3	25	
AGU08104	1/2-13 X 3 1/4	25	
AGU08112	1/2-13 X 3 1/2	25	
AGU08120	1/2-13 X 3 3/4	25	
AGU08128	1/2-13 X 4	25	
AGU08128FT	1/2-13 X 4 (FT)	25	
AGU08144	1/2-13 X 4 1/2	25	
AGU08160	1/2-13 X 5	25	
AGU08176	1/2-13 X 5 1/2	25	
AGU08192	1/2-13 X 6	25	

(continued...)



## HEX HEAD CAP SCREW (cont.)

304 STAINLESS STEEL - UNC

Line: 1107-00

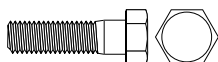

## HEX HEAD CAP SCREW (cont.)

304 STAINLESS STEEL - UNC

Line: 1107-00

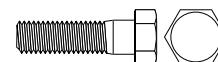

NON-FERROUS - SECTION 13 PAGE 13-20

PART NUMBER	SIZE	QTY/BX	LIST PRICE
AGU08208	1/2-13 X 6 1/2	25	
AGU08224	1/2-13 X 7	25	
AGU08256	1/2-13 X 8	25	
AGU08288	1/2-13 X 9	10	
AGU08320	1/2-13 X 10	25	
AGU08384	1/2-13 X 12	1	
AGU09032X	9/16-12 X 1	25	
AGU09040X	9/16-12 X 1 1/4	25	
AGU09048	9/16-12 X 1 1/2	25	
AGU09056	9/16-12 X 1 3/4	25	
AGU09064	9/16-12 X 2	25	
AGU09080X	9/16-12 X 2 1/2	25	
AGU09096	9/16-12 X 3	25	
AGU09112X	9/16-12 X 3 1/2	1	
AGU10032	5/8-11 X 1	25	
AGU10040	5/8-11 X 1 1/4	25	
AGU10048	5/8-11 X 1 1/2	25	
AGU10056	5/8-11 X 1 3/4	25	
AGU10064	5/8-11 X 2	25	
AGU10072	5/8-11 X 2 1/4	25	
AGU10080	5/8-11 X 2 1/2	25	
AGU10088	5/8-11 X 2 3/4	25	
AGU10096	5/8-11 X 3	25	
AGU10104	5/8-11 X 3 1/4	25	
AGU10112	5/8-11 X 3 1/2	25	
AGU10120	5/8-11 X 3 3/4	25	
AGU10128	5/8-11 X 4	25	
AGU10144	5/8-11 X 4 1/2	25	
AGU10160	5/8-11 X 5	25	
AGU10176	5/8-11 X 5 1/2	25	
AGU10192	5/8-11 X 6	25	
AGU10224	5/8-11 X 7	10	
AGU10256	5/8-11 X 8	10	
AGU10288	5/8-11 X 9	10	
AGU10320	5/8-11 X 10	10	
AGU10352	5/8-11 X 11	1	
AGU10384	5/8-11 X 12	10	
AGU10416	5/8-11 X 13	1	
AGU10448	5/8-11 X 14	1	

(continued...)

PART NUMBER	SIZE	QTY/BX	LIST PRICE
AGU12032	3/4-10 X 1	25	
AGU12040	3/4-10 X 1 1/4	25	
AGU12048	3/4-10 X 1 1/2	25	
AGU12056	3/4-10 X 1 3/4	25	
AGU12064	3/4-10 X 2	25	
AGU12072	3/4-10 X 2 1/4	25	
AGU12080	3/4-10 X 2 1/2	25	
AGU12088	3/4-10 X 2 3/4	25	
AGU12096	3/4-10 X 3	25	
AGU12104	3/4-10 X 3 1/4	25	
AGU12112	3/4-10 X 3 1/2	25	
AGU12120X	3/4-10 X 3 3/4	25	
AGU12128	3/4-10 X 4	25	
AGU12144	3/4-10 X 4 1/2	10	
AGU12160	3/4-10 X 5	10	
AGU12176	3/4-10 X 5 1/2	10	
AGU12192	3/4-10 X 6	10	
AGU12208	3/4-10 X 6 1/2	10	
AGU12224	3/4-10 X 7	10	
AGU12256	3/4-10 X 8	10	
AGU12288	3/4-10 X 9	5	
AGU12320	3/4-10 X 10	1	
AGU12352	3/4-10 X 11	5	
AGU12384	3/4-10 X 12	1	
AGU12448	3/4-10 X 14	1	
AGU14048	7/8-9 X 1 1/2	10	
AGU14056	7/8-9 X 1 3/4	10	
AGU14064	7/8-9 X 2	15	
AGU14072	7/8-9 X 2 1/4	15	
AGU14080	7/8-9 X 2 1/2	15	
AGU14088	7/8-9 X 2 3/4	10	
AGU14096	7/8-9 X 3	15	
AGU14104	7/8-9 X 3 1/4	15	
AGU14112	7/8-9 X 3 1/2	15	
AGU14128	7/8-9 X 4	10	
AGU14144	7/8-9 X 4 1/2	10	
AGU14160	7/8-9 X 5	10	
AGU14176	7/8-9 X 5 1/2	10	

(continued...)

CALL: (800) 723-2826

**HEX HEAD CAP SCREW (cont.)**

304 STAINLESS STEEL - UNC

Line: 1107-00

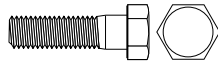

PART NUMBER	SIZE	QTY/BX	LIST PRICE
AGU14192	7/8-9 X 6	10	
AGU14224	7/8-9 X 7	10	
AGU14320	7/8-9 X 10	10	
AGU16064	1-8 X 2	10	
AGU16072X	1-8 X 2 1/4	10	
AGU16080	1-8 X 2 1/2	10	
AGU16088	1-8 X 2 3/4	10	
AGU16096	1-8 X 3	10	
AGU16104	1-8 X 3 1/4	1	
AGU16112	1-8 X 3 1/2	10	
AGU16128	1-8 X 4	10	
AGU16144	1-8 X 4 1/2	10	
AGU16160	1-8 X 5	10	
AGU16176	1-8 X 5 1/2	10	
AGU16192	1-8 X 6	10	
AGU16224	1-8 X 7	10	

**HEX HEAD CAP SCREW**

304 STAINLESS STEEL - UNF

Line: 1108-00

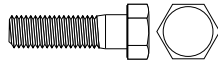

PART NUMBER	SIZE	QTY/BX	LIST PRICE
AGS04012X	1/4-28 X 3/8	100	
AGS04014X	1/4-28 X 7/16	1	
AGS04016	1/4-28 X 1/2	100	
AGS04024	1/4-28 X 3/4	100	
AGS04032	1/4-28 X 1	100	
AGS04040	1/4-28 X 1 1/4	100	
AGS04048	1/4-28 X 1 1/2	100	
AGS04056	1/4-28 X 1 3/4	100	
AGS04064	1/4-28 X 2	100	
AGS04072	1/4-28 X 2 1/4	50	
AGS04080	1/4-28 X 2 1/2	50	
AGS04128	1/4-28 X 4	25	
AGS05012X	5/16-24 X 3/8	100	
AGS05016	5/16-24 X 1/2	100	
AGS05020	5/16-24 X 5/8	100	
AGS05024	5/16-24 X 3/4	100	
AGS05028	5/16-24 X 7/8	100	
AGS05032	5/16-24 X 1	100	
AGS05040	5/16-24 X 1 1/4	100	

(continued...)

**HEX HEAD CAP SCREW (cont.)**

304 STAINLESS STEEL - UNF

Line: 1108-00

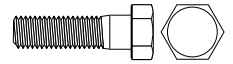

PART NUMBER	SIZE	QTY/BX	LIST PRICE
AGS05048	5/16-24 X 1 1/2	100	
AGS05056	5/16-24 X 1 3/4	100	
AGS05064	5/16-24 X 2	100	
AGS05072	5/16-24 X 2 1/4	50	
AGS05096	5/16-24 X 3	50	
AGS05144	5/16-24 X 4 1/2	25	
AGS05160	5/16-24 X 5	25	
AGS06016	3/8-24 X 1/2	100	
AGS06024	3/8-24 X 3/4	100	
AGS06032	3/8-24 X 1	100	
AGS06040	3/8-24 X 1 1/4	100	
AGS06048	3/8-24 X 1 1/2	100	
AGS06056	3/8-24 X 1 3/4	50	
AGS06064	3/8-24 X 2	50	
AGS06080	3/8-24 X 2 1/2	50	
AGS06096	3/8-24 X 3	50	
AGS06112	3/8-24 X 3 1/2	25	
AGS06128	3/8-24 X 4	25	
AGS06144	3/8-24 X 4 1/2	25	
AGS06160	3/8-24 X 5	25	
AGS06192	3/8-24 X 6	25	
AGS07032	7/16-20 X 1	50	
AGS07056	7/16-20 X 1 3/4	25	
AGS07096	7/16-20 X 3	25	
AGS08024	1/2-20 X 3/4	50	
AGS08032	1/2-20 X 1	50	
AGS08040	1/2-20 X 1 1/4	50	
AGS08048	1/2-20 X 1 1/2	50	
AGS08056	1/2-20 X 1 3/4	50	
AGS08064	1/2-20 X 2	50	
AGS08080	1/2-20 X 2 1/2	25	
AGS08096	1/2-20 X 3	25	
AGS08112X	1/2-20 X 3 1/2	25	
AGS08128	1/2-20 X 4	25	
AGS10064	5/8-18 X 2	25	
AGS10080	5/8-18 X 2 1/2	25	

**HEX HEAD CAP SCREW**

316 STAINLESS STEEL - UNC

Line: 1109-00

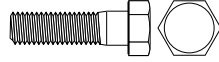

PART NUMBER	SIZE	QTY/BX	LIST PRICE
CMA04016	1/4-20 X 1/2	100	
CMA04020	1/4-20 X 5/8	100	
CMA04024	1/4-20 X 3/4	100	
CMA04028	1/4-20 X 7/8	100	
CMA04032	1/4-20 X 1	100	
CMA04040	1/4-20 X 1 1/4	100	
CMA04048	1/4-20 X 1 1/2	100	
CMA04056	1/4-20 X 1 3/4	100	
CMA04064	1/4-20 X 2	100	
CMA04072	1/4-20 X 2 1/4	50	
CMA04080	1/4-20 X 2 1/2	50	
CMA04088	1/4-20 X 2 3/4	50	
CMA04096	1/4-20 X 3	50	
CMA04112X	1/4-20 X 3 1/2	25	
CMA04128X	1/4-20 X 4	25	
CMA04256	1/4-20 X 8	25	
CMA05016	5/16-18 X 1/2	100	
CMA05020X	5/16-18 X 5/8	100	
CMA05024	5/16-18 X 3/4	100	
CMA05028	5/16-18 X 7/8	100	
CMA05028Q50	5/16-18 X 7/8	50	
CMA05032	5/16-18 X 1	100	
CMA05040	5/16-18 X 1 1/4	100	
CMA05048	5/16-18 X 1 1/2	100	
CMA05056	5/16-18 X 1 3/4	100	
CMA05064	5/16-18 X 2	100	
CMA05072	5/16-18 X 2 1/4	50	
CMA05080	5/16-18 X 2 1/2	50	
CMA05088	5/16-18 X 2 3/4	50	
CMA05096	5/16-18 X 3	50	
CMA05112	5/16-18 X 3 1/2	25	
CMA05128	5/16-18 X 4	25	
CMA06016	3/8-16 X 1/2	100	
CMA06020	3/8-16 X 5/8	100	
CMA06024	3/8-16 X 3/4	100	
CMA06028	3/8-16 X 7/8	100	
CMA06032	3/8-16 X 1	100	
CMA06040	3/8-16 X 1 1/4	100	

(continued...)

**HEX HEAD CAP SCREW (cont.)**

316 STAINLESS STEEL - UNC

Line: 1109-00

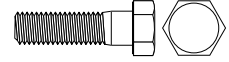

PART NUMBER	SIZE	QTY/BX	LIST PRICE
CMA06048	3/8-16 X 1 1/2	100	
CMA06056	3/8-16 X 1 3/4	50	
CMA06064	3/8-16 X 2	50	
CMA06072	3/8-16 X 2 1/4	50	
CMA06080	3/8-16 X 2 1/2	50	
CMA06088	3/8-16 X 2 3/4	50	
CMA06096	3/8-16 X 3	50	
CMA06112	3/8-16 X 3 1/2	25	
CMA06128	3/8-16 X 4	25	
CMA06144	3/8-16 X 4 1/2	25	
CMA06160	3/8-16 X 5	25	
CMA07032	7/16-14 X 1	50	
CMA07040	7/16-14 X 1 1/4	50	
CMA07048	7/16-14 X 1 1/2	50	
CMA07056	7/16-14 X 1 3/4	50	
CMA07064	7/16-14 X 2	50	
CMA07080	7/16-14 X 2 1/2	25	
CMA07096	7/16-14 X 3	25	
CMA08024	1/2-13 X 3/4	50	
CMA08032	1/2-13 X 1	50	
CMA08040	1/2-13 X 1 1/4	50	
CMA08048	1/2-13 X 1 1/2	50	
CMA08056	1/2-13 X 1 3/4	50	
CMA08064	1/2-13 X 2	50	
CMA08072	1/2-13 X 2 1/4	25	
CMA08080	1/2-13 X 2 1/2	25	
CMA08088	1/2-13 X 2 3/4	25	
CMA08096	1/2-13 X 3	25	
CMA08104	1/2-13 X 3-1/4	25	
CMA08112	1/2-13 X 3 1/2	25	
CMA08120	1/2-13 X 3 3/4	25	
CMA08128	1/2-13 X 4	25	
CMA08144	1/2-13 X 4 1/2	25	
CMA08160	1/2-13 X 5	25	
CMA08176	1/2-13 X 5 1/2	25	
CMA08192	1/2-13 X 6	25	
CMA08256	1/2-13 X 8	25	
CMA10032	5/8-11 X 1	25	
CMA10040	5/8-11 X 1 1/4	25	

(continued...)

**HEX HEAD CAP SCREW (cont.)**

316 STAINLESS STEEL - UNC

Line: 1109-00

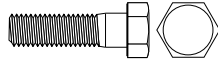

PART NUMBER	SIZE	QTY/BX	LIST PRICE
CMA10048	5/8-11 X 1 1/2	25	
CMA10056	5/8-11 X 1 3/4	25	
CMA10064	5/8-11 X 2	25	
CMA10072	5/8-11 X 2 1/4	25	
CMA10080	5/8-11 X 2 1/2	25	
CMA10088	5/8-11 X 2 3/4	25	
CMA10096	5/8-11 X 3	25	
CMA10104	5/8-11 X 3 1/4	25	
CMA10112	5/8-11 X 3 1/2	25	
CMA10128	5/8-11 X 4	25	
CMA10144	5/8-11 X 4 1/2	25	
CMA10160	5/8-11 X 5	25	
CMA10176	5/8-11 X 5 1/2	25	
CMA10192	5/8-11 X 6	25	
CMA10256	5/8-11 X 8	1	
CMA10288	5/8-11 X 9	10	
CMA10320	5/8-11 X 10	10	
CMA10384	5/8-11 X 12	10	
CMA12040	3/4-10 X 1 1/4	25	
CMA12048	3/4-10 X 1 1/2	25	
CMA12056	3/4-10 X 1 3/4	25	
CMA12064	3/4-10 X 2	25	
CMA12072	3/4-10 X 2 1/4	25	
CMA12080	3/4-10 X 2 1/2	25	
CMA12088	3/4-10 X 2 3/4	25	
CMA12096	3/4-10 X 3	25	
CMA12104	3/4-10 X 3 1/4	25	
CMA12112	3/4-10 X 3 1/2	25	
CMA12120	3/4-10 X 3 3/4	25	
CMA12128	3/4-10 X 4	25	
CMA12144	3/4-10 X 4 1/2	10	
CMA12160	3/4-10 X 5	10	
CMA12176	3/4-10 X 5 1/2	10	
CMA12192	3/4-10 X 6	10	
CMA12256	3/4-10 X 8	1	
CMA12288	3/4-10 X 9	10	
CMA12320	3/4-10 X 10	10	
CMA12384	3/4-10 X 12	10	
CMA14048	7/8-9 X 1 1/2	10	

(continued...)

**HEX HEAD CAP SCREW (cont.)**

316 STAINLESS STEEL - UNC

Line: 1109-00

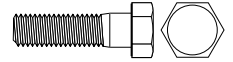

PART NUMBER	SIZE	QTY/BX	LIST PRICE
CMA14064	7/8-9 X 2	15	
CMA14072	7/8-9 X 2 1/4	15	
CMA14080	7/8-9 X 2 1/2	15	
CMA14088	7/8-9 X 2 3/4	15	
CMA14096	7/8-9 X 3	15	
CMA14112X	7/8-9 X 3 1/2	15	
CMA14128	7/8-9 X 4	10	
CMA14144	7/8-9 X 4 1/2	10	
CMA14160	7/8-9 X 5	10	
CMA14176X	7/8-9 X 5 1/2	10	
CMA14192	7/8-9 X 6	10	
CMA16064	1-8 X 2	10	
CMA16080	1-8 X 2 1/2	10	
CMA16096	1-8 X 3	10	
CMA16112	1-8 X 3 1/2	10	
CMA16128	1-8 X 4	10	
CMA16144	1-8 X 4 1/2	10	
CMA16160	1-8 X 5	10	
CMA16176	1-8 X 5 1/2	10	
CMA16192	1-8 X 6	10	
CMA18080	1 1/8-7 X 2 1/2	1	
CMA18112	1 1/8-7 X 3 1/2	1	
CMA18144	1 1/8-7 X 4 1/2	1	
CMA18160	1 1/8-7 X 5	1	
CMA18176	1 1/8-7 X 5 1/2	1	
CMA18192	1 1/8-7 X 6	1	
CMA20096	1 1/4-7 X 3	1	
CMA20128	1 1/4-7 X 4	1	
CMA20144	1 1/4-7 X 4 1/2	1	
CMA20192	1 1/4-7 X 6	1	
CMA20208	1 1/4-7 X 6 1/2	1	
CMA20224	1 1/4-7 X 7	1	
CMA24160	1 1/2-6 X 5	1	

# HEX HEAD CAP SCREW

BRASS - UNC

Line: 1110-00

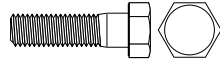

# HEX HEAD CAP SCREW (cont.)

BRASS - UNC

Line: 1110-00

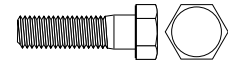

NON-FERROUS - SECTION 13 PAGE 13-24

PART NUMBER	SIZE	QTY/BX	LIST PRICE
AHU04016	1/4-20 X 1/2	100	
AHU04020	1/4-20 X 5/8	100	
AHU04024	1/4-20 X 3/4	100	
AHU04028	1/4-20 X 7/8	100	
AHU04032	1/4-20 X 1	100	
AHU04040	1/4-20 X 1 1/4	100	
AHU04048	1/4-20 X 1 1/2	100	
AHU04056	1/4-20 X 1 3/4	100	
AHU04064	1/4-20 X 2	100	
AHU04072	1/4-20 X 2 1/4	50	
AHU04080	1/4-20 X 2 1/2	50	
AHU04096	1/4-20 X 3	50	
AHU05016	5/16-18 X 1/2	100	
AHU05020	5/16-18 X 5/8	100	
AHU05024	5/16-18 X 3/4	100	
AHU05032	5/16-18 X 1	100	
AHU05040	5/16-18 X 1 1/4	100	
AHU05048	5/16-18 X 1 1/2	100	
AHU05056	5/16-18 X 1 3/4	100	
AHU05064	5/16-18 X 2	100	
AHU05080	5/16-18 X 2 1/2	50	
AHU05096	5/16-18 X 3	50	
AHU06016	3/8-16 X 1/2	100	
AHU06020	3/8-16 X 5/8	100	
AHU06024	3/8-16 X 3/4	100	
AHU06028	3/8-16 X 7/8	100	
AHU06032	3/8-16 X 1	100	
AHU06040	3/8-16 X 1 1/4	100	
AHU06048	3/8-16 X 1 1/2	100	
AHU06056	3/8-16 X 1 3/4	100	
AHU06064	3/8-16 X 2	50	
AHU06064C	3/8-16 X 2	100	
AHU06072	3/8-16 X 2 1/4	50	
AHU06080	3/8-16 X 2 1/2	50	
AHU06088	3/8-16 X 2 3/4	50	
AHU06096	3/8-16 X 3	50	
AHU06112	3/8-16 X 3 1/2	25	
AHU06112Q50	3/8-16 X 3 1/2	50	
AHU06128	3/8-16 X 4	25	

(continued...)

PART NUMBER	SIZE	QTY/BX	LIST PRICE
AHU07032	7/16-14 X 1	50	
AHU07040	7/16-14 X 1 1/4	50	
AHU07048	7/16-14 X 1 1/2	50	
AHU07064	7/16-14 X 2	50	
AHU07080X	7/16-14 X 2 1/2	25	
AHU08024	1/2-13 X 3/4	50	
AHU08032	1/2-13 X 1	50	
AHU08040	1/2-13 X 1 1/4	50	
AHU08048	1/2-13 X 1 1/2	50	
AHU08056	1/2-13 X 1 3/4	50	
AHU08064	1/2-13 X 2	50	
AHU08072	1/2-13 X 2 1/4	25	
AHU08080	1/2-13 X 2 1/2	25	
AHU08088	1/2-13 X 2 3/4	25	
AHU08096	1/2-13 X 3	25	
AHU08112	1/2-13 X 3 1/2	25	
AHU08128	1/2-13 X 4	25	
AHU08160X	1/2-13 X 5	25	
AHU10032	5/8-11 X 1	25	
AHU10040	5/8-11 X 1 1/4	25	
AHU10048	5/8-11 X 1 1/2	25	
AHU10056	5/8-11 X 1 3/4	25	
AHU10064	5/8-11 X 2	25	
AHU10072	5/8-11 X 2 1/4	25	
AHU10080	5/8-11 X 2 1/2	25	
AHU10088	5/8-11 X 2 3/4	25	
AHU10096	5/8-11 X 3	25	
AHU10112	5/8-11 X 3 1/2	25	
AHU10128	5/8-11 X 4	25	
AHU10160X	5/8-11 X 5	25	
AHU12040	3/4-10 X 1 1/4	25	
AHU12048	3/4-10 X 1 1/2	25	
AHU12056	3/4-10 X 1 3/4	25	
AHU12064	3/4-10 X 2	25	
AHU12080	3/4-10 X 2 1/2	25	
AHU12096	3/4-10 X 3	25	
AHU12112	3/4-10 X 3 1/2	25	
AHU12128	3/4-10 X 4	25	

CALL: (800) 723-2826

## HEX HEAD CAP SCREW

SILICON BRONZE - UNC

Line: 1112-00

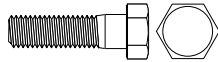

PART NUMBER	SIZE	QTY/BX	LIST PRICE
CNA04016	1/4-20 X 1/2	100	
CNA04020	1/4-20 X 5/8	100	
CNA04024	1/4-20 X 3/4	100	
CNA04028	1/4-20 X 7/8	100	
CNA04032	1/4-20 X 1	100	
CNA04040	1/4-20 X 1 1/4	100	
CNA04048	1/4-20 X 1 1/2	100	
CNA04064	1/4-20 X 2	100	
CNA04096	1/4-20 X 3	50	
CNA05016	5/16-18 X 1/2	100	
CNA05024	5/16-18 X 3/4	100	
CNA05028	5/16-18 X 7/8	100	
CNA05032	5/16-18 X 1	100	
CNA05048	5/16-18 X 1 1/2	100	
CNA05064	5/16-18 X 2	100	
CNA06016	3/8-16 X 1/2	100	
CNA06020	3/8-16 X 5/8	100	
CNA06024	3/8-16 X 3/4	100	
CNA06028	3/8-16 X 7/8	100	
CNA06032	3/8-16 X 1	100	
CNA06040	3/8-16 X 1 1/4	100	
CNA06048	3/8-16 X 1 1/2	100	
CNA06056	3/8-16 X 1 3/4	100	
CNA06064	3/8-16 X 2	50	
CNA06080	3/8-16 X 2 1/2	50	
CNA06096	3/8-16 X 3	50	
CNA06112	3/8-16 X 3 1/2	25	
CNA07040	7/16-14 X 1 1/4	50	
CNA08032	1/2-13 X 1	50	
CNA08040	1/2-13 X 1 1/4	50	
CNA08048	1/2-13 X 1 1/2	50	
CNA08056	1/2-13 X 1 3/4	25	
CNA08064	1/2-13 X 2	25	
CNA08080	1/2-13 X 2 1/2	25	
CNA08096	1/2-13 X 3	25	
CNA08144	1/2-13 X 4 1/2	25	
CNA10056	5/8-11 X 1 3/4	25	
CNA10080	5/8-11 X 2 1/2	25	
CNA10088	5/8-11 X 2 3/4	25	

(continued...)

## HEX HEAD CAP SCREW (cont.)

SILICON BRONZE - UNC

Line: 1112-00

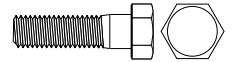

PART NUMBER	SIZE	QTY/BX	LIST PRICE
CNA10096	5/8-11 X 3	25	
CNA10128	5/8-11 X 4	25	

## HEX HEAD CAP SCREW

NYLON - UNC

Line: 1113-00

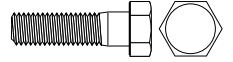

PART NUMBER	SIZE	QTY/BX	LIST PRICE
CPA04016	1/4-20 X 1/2	100	
CPA04024	1/4-20 X 3/4	100	
CPA04032	1/4-20 X 1	100	
CPA04040	1/4-20 X 1 1/4	100	
CPA04048	1/4-20 X 1 1/2	100	
CPA04064	1/4-20 X 2	100	
CPA05024	5/16-18 X 3/4	100	
CPA05032	5/16-18 X 1	100	
CPA05040	5/16-18 X 1 1/4	100	
CPA05048	5/16-18 X 1 1/2	100	
CPA05064	5/16-18 X 2	100	
CPA05080	5/16-18 X 2 1/2	50	
CPA05096	5/16-18 X 3	50	
CPA06032	3/8-16 X 1	100	
CPA06040	3/8-16 X 1 1/4	100	
CPA06048	3/8-16 X 1 1/2	100	
CPA06064	3/8-16 X 2	50	
CPA06080	3/8-16 X 2 1/2	50	
CPA08024	1/2-13 X 3/4	50	
CPA08032	1/2-13 X 1	50	
CPA08040	1/2-13 X 1 1/4	50	
CPA08048	1/2-13 X 1 1/2	50	
CPA08056	1/2-13 X 1 3/4	50	
CPA08064	1/2-13 X 2	50	
CPA08096	1/2-13 X 3	25	

## HEX HEAD CAP SCREW

ALUMINUM - UNC

Line: 1113-01

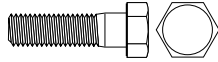

PART NUMBER	SIZE	QTY/BX	LIST PRICE
JYE04024X	1/4-20 X 3/4	100	
JYE04032X	1/4-20 X 1	100	
JYE04048X	1/4-20 X 1 1/2	100	
JYE04056	1/4-20 X 1 3/4	100	
JYE04064	1/4-20 X 2	100	
JYE04096	1/4-20 X 3	50	
JYE04112	1/4-20 X 3 1/2	50	
JYE04128	1/4-20 X 4	50	
JYE05032	5/16-18 X 1	100	
JYE05040	5/16-18 X 1 1/4	100	
JYE05048X	5/16-18 X 1 1/2	100	
JYE05064	5/16-18 X 2	100	
JYE06024X	3/8-16 X 3/4	100	
JYE06032	3/8-16 X 1	100	
JYE06040	3/8-16 X 1 1/4	100	
JYE06048	3/8-16 X 1 1/2	100	
JYE06048FT	3/8-16 X 1 1/2 (FULL THREAD)	100	
JYE06064	3/8-16 X 2	100	
JYE08032	1/2-13 X 1	50	
JYE08048X	1/2-13 X 1 1/2	50	
JYE08056	1/2-13 X 1 3/4	50	

**NOTE: LARGER DIAMETER AND LONGER LENGTHS AVAILABLE**

## LAG BOLTS

304 STAINLESS STEEL

Line: 1115-00



PART NUMBER	SIZE	QTY/BX	LIST PRICE
HWA04032	1/4 X 1	50	
HWA04040	1/4 X 1 1/4	50	
HWA04048	1/4 X 1 1/2	100	
HWA04064	1/4 X 2	50	
HWA04080	1/4 X 2 1/2	50	
HWA04096	1/4 X 3	50	
HWA04112	1/4 X 3 1/2	50	
HWA04128	1/4 X 4	50	
HWA04144	1/4 X 4 1/2	50	
HWA04160	1/4 X 5	50	
HWA04192	1/4 X 6	50	

(continued...)

## LAG BOLTS (cont.)

304 STAINLESS STEEL

Line: 1115-00

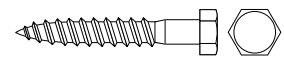

PART NUMBER	SIZE	QTY/BX	LIST PRICE
HWA05032	5/16 X 1	100	
HWA05040	5/16 X 1 1/4	50	
HWA05048	5/16 X 1 1/2	50	
HWA05064	5/16 X 2	50	
HWA05080	5/16 X 2 1/2	50	
HWA05096	5/16 X 3	50	
HWA05112	5/16 X 3 1/2	50	
HWA05128	5/16 X 4	50	
HWA05144	5/16 X 4 1/2	25	
HWA05160	5/16 X 5	25	
HWA05192	5/16 X 6	25	
HWA06032	3/8 X 1	50	
HWA06040	3/8 X 1 1/4	50	
HWA06048	3/8 X 1 1/2	50	
HWA06056	3/8 X 1 3/4	50	
HWA06064	3/8 X 2	50	
HWA06080	3/8 X 2 1/2	50	
HWA06096	3/8 X 3	50	
HWA06112	3/8 X 3 1/2	50	
HWA06128	3/8 X 4	25	
HWA06144	3/8 X 4 1/2	25	
HWA06160	3/8 X 5	25	
HWA06192	3/8 X 6	25	
HWA06224	3/8 X 7	25	
HWA08048	1/2 X 1 1/2	50	
HWA08064	1/2 X 2	25	
HWA08080	1/2 X 2 1/2	25	
HWA08096	1/2 X 3	25	
HWA08112	1/2 X 3 1/2	25	
HWA08128	1/2 X 4	25	
HWA08144	1/2 X 4 1/2	25	
HWA08160	1/2 X 5	25	
HWA08192	1/2 X 6	25	
HWA08256	1/2 X 8	25	
HWA10160	5/8 X 5	25	

## CARRIAGE BOLTS

304 STAINLESS STEEL

Line: 1116-00

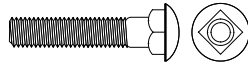

PART NUMBER	SIZE	QTY/BX	LIST PRICE
CXA03016	10/24 X 1/2	100	
CXA03020	10/24 X 5/8	100	
CXA03024	10/24 X 3/4	100	
CXA03040	10/24 X 1 1/4	100	
CXA03048	10/24 X 1 1/2	100	
CXA04016	1/4-20 X 1/2	100	
CXA04024	1/4-20 X 3/4	100	
CXA04032	1/4-20 X 1	100	
CXA04040	1/4-20 X 1 1/4	100	
CXA04048	1/4-20 X 1 1/2	100	
CXA04056	1/4-20 X 1 3/4	100	
CXA04064	1/4-20 X 2	100	
CXA04080	1/4-20 X 2 1/2	50	
CXA04096	1/4-20 X 3	50	
CXA04112	1/4-20 X 3 1/2	50	
CXA04128	1/4-20 X 4	50	
CXA04144	1/4-20 X 4 1/2	50	
CXA04160	1/4-20 X 5	50	
CXA04192	1/4-20 X 6	50	
CXA05024	5/16-18 X 3/4	100	
CXA05032	5/16-18 X 1	100	
CXA05040	5/16-18 X 1 1/4	100	
CXA05048	5/16-18 X 1 1/2	100	
CXA05056	5/16-18 X 1 3/4	100	
CXA05064	5/16-18 X 2	100	
CXA05080	5/16-18 X 2 1/2	50	
CXA05096	5/16-18 X 3	50	
CXA05112	5/16-18 X 3 1/2	50	
CXA05128	5/16-18 X 4	25	
CXA05160	5/16-18 X 5	25	
CXA05192	5/16-18 X 6	25	
CXA06024	3/8-16 X 3/4	100	
CXA06032	3/8-16 X 1	100	
CXA06040	3/8-16 X 1 1/4	100	
CXA06048	3/8-16 X 1 1/2	100	
CXA06056	3/8-16 X 1 3/4	50	
CXA06064	3/8-16 X 2	50	
CXA06072	3/8-16 X 2 1/4	50	
CXA06080	3/8-16 X 2 1/2	50	

(continued...)

## CARRIAGE BOLTS (cont.)

304 STAINLESS STEEL

Line: 1116-00

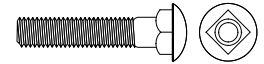

PART NUMBER	SIZE	QTY/BX	LIST PRICE
CXA06096	3/8-16 X 3	50	
CXA06112	3/8-16 X 3 1/2	25	
CXA06128	3/8-16 X 4	25	
CXA06160	3/8-16 X 5	25	
CXA06192	3/8-16 X 6	25	
CXA08032	1/2-13 X 1	50	
CXA08040	1/2-13 X 1 1/4	50	
CXA08048X	1/2-13 X 1 1/2	50	
CXA08056	1/2-13 X 1 3/4	50	
CXA08064	1/2-13 X 2	25	
CXA08080	1/2-13 X 2 1/2	25	
CXA08096	1/2-13 X 3	25	
CXA08112	1/2-13 X 3 1/2	25	
CXA08128	1/2-13 X 4	25	
CXA08144	1/2-13 X 4 1/2	25	
CXA08160	1/2-13 X 5	25	
CXA08176	1/2-13 X 5 1/2	25	
CXA08192	1/2-13 X 6	25	
CXA08224	1/2-13 X 7	25	
CXA08256	1/2-13 X 8	25	
CXA08384	1/2-13 X 12	10	
CXA08448	1/2-13 X 14	1	
CXA10064X	5/8-11 X 2	25	
CXA10080	5/8-11 X 2 1/2	25	
CXA10128	5/8-11 X 4	1	
CXA10192X	5/8-11 X 6	25	
CXA12080X	3/4 X 2 1/2	25	
CXA12160	3/4-10 X 5	5	



**SLOTTED ROUND MACHINE SCREW**

304 STAINLESS STEEL

Line: 1117-00

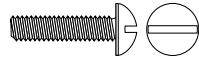

PART NUMBER	SIZE	QTY/BX	LIST PRICE
EBA03010	10-24 X 5/16	100	
EBA22004	2/56 X 1/8	100	
EBA22006	2/56 X 3/16	100	
EBA22008	2/56 X 1/4	100	
EBA22010	2/56 X 5/16	100	
EBA22012	2/56 X 3/8	100	
EBA22016	2/56 X 1/2	100	
EBA22020X	2/56 X 5/8	100	
EBA22024	2/56 X 3/4	100	
EBA22032	2/56 X 1	100	
EBA33004	3/48 X 1/8	100	
EBA33006	3/48 X 3/16	100	
EBA33008	3/48 X 1/4	100	
EBA33010	3/48 X 5/16	100	
EBA33012	3/48 X 3/8	100	
EBA33016	3/48 X 1/2	100	
EBA33024	3/48 X 3/4	100	
EBA533006X	3/56 X 3/16	100	
EBA533008X	3/56 X 1/4	100	
EBA533010X	3/56 X 5/16	100	
EBA533012	3/56 X 3/8	100	
EBA544012X	4/36 X 3/8	100	
EBA44004	4/40 X 1/8	100	
EBA44006	4/40 X 3/16	100	
EBA44008	4/40 X 1/4	100	
EBA44010	4/40 X 5/16	100	
EBA44012	4/40 X 3/8	100	
EBA44014	4/40 X 7/16	100	
EBA44016	4/40 X 1/2	100	
EBA44020	4/40 X 5/8	100	
EBA44024	4/40 X 3/4	100	
EBA44028X	4/40 X 7/8	100	
EBA44032	4/40 X 1	100	
EBA44040	4/40 X 1 1/4	100	
EBA44048	4/40 X 1 1/2	100	
EBA44064	4/40 X 2	100	
EBA55006	5/40 X 3/16	100	
EBA55012	5/40 X 3/8	100	
EBA55016	5/40 X 1/2	100	
EBA55024X	5/40 X 3/4	100	

(continued...)

**SLOTTED ROUND MACHINE SCREW (cont.)**

304 STAINLESS STEEL

Line: 1117-00

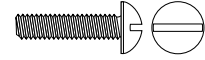

PART NUMBER	SIZE	QTY/BX	LIST PRICE
EBA55032X	5/40 X 1	100	
EBA66006	6/32 X 3/16	100	
EBA66008	6/32 X 1/4	100	
EBA66010	6/32 X 5/16	100	
EBA66012	6/32 X 3/8	100	
EBA66014	6/32 X 7/16	100	
EBA66016	6/32 X 1/2	100	
EBA66020	6/32 X 5/8	100	
EBA66024	6/32 X 3/4	100	
EBA66028	6/32 X 7/8	100	
EBA66032	6/32 X 1	100	
EBA66040	6/32 X 1 1/4	100	
EBA66048	6/32 X 1 1/2	100	
EBA66056	6/32 X 1 3/4	100	
EBA66064	6/32 X 2	100	
EBA66080	6/32 X 2 1/2	100	
EBA66096	6/32 X 3	100	
EBA88006	8/32 X 3/16	100	
EBA88008	8/32 X 1/4	100	
EBA88010	8/32 X 5/16	100	
EBA88012	8/32 X 3/8	100	
EBA88014	8/32 X 7/16	100	
EBA88016	8/32 X 1/2	100	
EBA88020	8/32 X 5/8	100	
EBA88024	8/32 X 3/4	100	
EBA88028	8/32 X 7/8	100	
EBA88032	8/32 X 1	100	
EBA88040	8/32 X 1 1/4	100	
EBA88048	8/32 X 1 1/2	100	
EBA88056	8/32 X 1 3/4	100	
EBA88064	8/32 X 2	100	
EBA88072X	8/32 X 2 1/4	100	
EBA88080X	8/32 X 2 1/2	100	
EBA88096	8/32 X 3	100	
EBA88112	8/32 X 3 1/2	100	
EBA88128	8/32 X 4	100	
EBA03008	10/24 X 1/4	100	
EBA03012	10/24 X 3/8	100	
EBA03014X	10/24 X 7/16	100	
EBA03016	10/24 X 1/2	100	

(continued...)

**CALL: (800) 723-2826**

**SLOTTED ROUND MACHINE SCREW (cont.)**

304 STAINLESS STEEL

Line: 1117-00

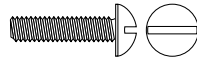

PART NUMBER	SIZE	QTY/BX	LIST PRICE
EBA03018X	10/24 X 9/16	100	
EBA03020	10/24 X 5/8	100	
EBA03024	10/24 X 3/4	100	
EBA03028	10/24 X 7/8	100	
EBA03032	10/24 X 1	100	
EBA03040	10/24 X 1 1/4	100	
EBA03048	10/24 X 1 1/2	100	
EBA03056	10/24 X 1 3/4	100	
EBA03064	10/24 X 2	100	
EBA03080	10/24 X 2 1/2	50	
EBA03096	10/24 X 3	50	
EBA03112	10/24 X 3 1/2	50	
EBA03128	10/24 X 4	50	
EBAS03008	10/32 X 1/4	100	
EBAS03010	10/32 X 5/16	100	
EBAS03012	10/32 X 3/8	100	
EBAS03014	10/32 X 7/16	100	
EBAS03016	10/32 X 1/2	100	
EBAS03020	10/32 X 5/8	100	
EBAS03024	10/32 X 3/4	100	
EBAS03028	10/32 X 7/8	100	
EBAS03032	10/32 X 1	100	
EBAS03036	10/32 X 1 1/8	100	
EBAS03040	10/32 X 1 1/4	100	
EBAS03048	10/32 X 1 1/2	100	
EBAS03056	10/32 X 1 3/4	100	
EBAS03064	10/32 X 2	100	
EBAS03080	10/32 X 2 1/2	50	
EBAS03096	10/32 X 3	50	
EBAS03096C	10/32 X 3	100	
EBA21012	12/24 X 3/8	100	
EBA21016	12/24 X 1/2	100	
EBA21020	12/24 X 5/8	100	
EBA21024	12/24 X 3/4	100	
EBA21032	12/24 X 1	100	
EBA21040	12/24 X 1 1/4	100	
EBA21048	12/24 X 1 1/2	100	
EBA21064	12/24 X 2	100	
EBA04008	1/4-20 X 1/4	100	
EBA04012	1/4-20 X 3/8	100	

(continued...)

**SLOTTED ROUND MACHINE SCREW (cont.)**

304 STAINLESS STEEL

Line: 1117-00

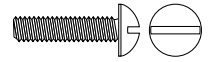

PART NUMBER	SIZE	QTY/BX	LIST PRICE
EBA04016	1/4-20 X 1/2	100	
EBA04020	1/4-20 X 5/8	100	
EBA04024	1/4-20 X 3/4	100	
EBA04028	1/4-20 X 7/8	100	
EBA04032	1/4-20 X 1	100	
EBA04040	1/4-20 X 1 1/4	100	
EBA04048	1/4-20 X 1 1/2	100	
EBA04056	1/4-20 X 1 3/4	100	
EBA04064	1/4-20 X 2	100	
EBA04072X	1/4-20 X 2 1/4	50	
EBA04080	1/4-20 X 2 1/2	50	
EBA04096	1/4-20 X 3	50	
EBA04112	1/4-20 X 3 1/2	50	
EBA04128	1/4-20 X 4	50	
EBAS04024	1/4-28 X 3/4	100	
EBA05016	5/16-18 X 1/2	100	
EBA05020X	5/16-18 X 5/8	100	
EBA05024	5/16-18 X 3/4	100	
EBA05028	5/16-18 X 7/8	100	
EBA05032	5/16-18 X 1	100	
EBA05040	5/16-18 X 1 1/4	100	
EBA05048	5/16-18 X 1 1/2	100	
EBA05056	5/16-18 X 1 3/4	100	
EBA05064	5/16-18 X 2	100	
EBA05080	5/16-18 X 2 1/2	50	
EBA05096	5/16-18 X 3	50	
EBA05112	5/16-18 X 3 1/2	50	
EBA05128	5/16-18 X 4	50	
EBA06016	3/8-16 X 1/2	50	
EBA06020	3/8-16 X 5/8	50	
EBA06024	3/8-16 X 3/4	50	
EBA06032	3/8-16 X 1	50	
EBA06040	3/8-16 X 1 1/4	50	
EBA06048	3/8-16 X 1 1/2	50	
EBA06056	3/8-16 X 1 3/4	50	
EBA06064	3/8-16 X 2	50	
EBA06080	3/8-16 X 2 1/2	50	
EBA06096	3/8-16 X 3	50	
EBA06128	3/8-16 X 4	50	

# SLOTTED FLAT MACHINE SCREW

304 STAINLESS STEEL

Line: 1118-00

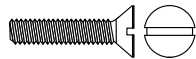

PART NUMBER	SIZE	QTY/BX	LIST PRICE
ECA00004	0/80 X 1/8	100	
ECA00008X	0/80 X 1/4	100	
ECA22004	2/56 X 1/8 (UC)	100	
ECA22006	2/56 X 3/16	100	
ECA22008	2/56 X 1/4	100	
ECA22012	2/56 X 3/8	100	
ECA22014	2/56 X 7/16	100	
ECA22016	2/56 X 1/2	100	
ECA22024	2/56 X 3/4	100	
ECA33004	3/48 X 1/8	100	
ECA33008	3/48 X 1/4	100	
ECA44004	4/40 X 1/8	100	
ECA44006	4/40 X 3/16	100	
ECA44008	4/40 X 1/4	100	
ECA44010	4/40 X 5/16	100	
ECA44012	4/40 X 3/8	100	
ECA44014	4/40 X 7/16	100	
ECA44016	4/40 X 1/2	100	
ECA44020	4/40 X 5/8	100	
ECA44024	4/40 X 3/4	100	
ECA44028	4/40 X 7/8	100	
ECA44032	4/40 X 1	100	
ECAS44024	4/48 X 3/4	500	
ECA55008X	5/40 X 1/4	100	
ECA55012X	5/40 X 3/8	100	
ECA55016X	5/40 X 1/2	100	
ECA55020X	5/40 X 5/8	100	
ECA55024X	5/40 X 3/4	100	
ECA55032X	5/40 X 1	100	
ECA66006	6/32 X 3/16	100	
ECA66008	6/32 X 1/4	100	
ECA66010	6/32 X 5/16	100	
ECA66012	6/32 X 3/8	100	
ECA66014	6/32 X 7/16	100	
ECA66016	6/32 X 1/2	100	
ECA66020	6/32 X 5/8	100	
ECA66024	6/32 X 3/4	100	
ECA66028	6/32 X 7/8	100	
ECA66032	6/32 X 1	100	

(continued...)

# SLOTTED FLAT MACHINE SCREW (cont.)

304 STAINLESS STEEL

Line: 1118-00

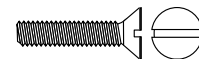

PART NUMBER	SIZE	QTY/BX	LIST PRICE
ECA66040	6/32 X 1 1/4	100	
ECA66048	6/32 X 1 1/2	100	
ECA66056	6/32 X 1 3/4	100	
ECA66064	6/32 X 2	100	
ECA66080	6/32 X 2 1/2	100	
ECA66096	6/32 X 3	100	
ECA88008	8/32 X 1/4	100	
ECA88010	8/32 X 5/16	100	
ECA88012	8/32 X 3/8	100	
ECA88014	8/32 X 7/16	100	
ECA88016	8/32 X 1/2	100	
ECA88020	8/32 X 5/8	100	
ECA88024	8/32 X 3/4	100	
ECA88028	8/32 X 7/8	100	
ECA88032	8/32 X 1	100	
ECA88040	8/32 X 1 1/4	100	
ECA88048	8/32 X 1 1/2	100	
ECA88056	8/32 X 1 3/4	100	
ECA88064	8/32 X 2	100	
ECA88080	8/32 X 2 1/2	50	
ECA88096	8/32 X 3	50	
ECA03008	10/24 X 1/4	100	
ECA03010	10/24 X 5/16	100	
ECA03012	10/24 X 3/8	100	
ECA03016	10/24 X 1/2	100	
ECA03020	10/24 X 5/8	100	
ECA03024	10/24 X 3/4	100	
ECA03028	10/24 X 7/8	100	
ECA03032	10/24 X 1	100	
ECA03040	10/24 X 1 1/4	100	
ECA03048	10/24 X 1 1/2	100	
ECA03056	10/24 X 1 3/4	100	
ECA03064	10/24 X 2	100	
ECA03080	10/24 X 2 1/2	50	
ECA03096	10/24 X 3	50	
ECAS03008	10/32 X 1/4	100	
ECAS03010	10/32 X 5/16	100	
ECAS03012	10/32 X 3/8	100	
ECAS03014	10/32 X 7/16	100	
ECAS03016	10/32 X 1/2	100	

(continued...)

**SLOTTED FLAT MACHINE SCREW (cont.)**

304 STAINLESS STEEL

Line: 1118-00

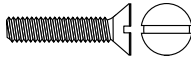

PART NUMBER	SIZE	QTY/BX	LIST PRICE
ECAS03020	10/32 X 5/8	100	
ECAS03024	10/32 X 3/4	100	
ECAS03028	10/32 X 7/8	100	
ECAS03032	10/32 X 1	100	
ECAS03040	10/32 X 1 1/4	100	
ECAS03048	10/32 X 1 1/2	100	
ECAS03056	10/32 X 1 3/4	100	
ECAS03064	10/32 X 2	100	
ECAS03080	10/32 X 2 1/2	50	
ECAS03096	10/32 X 3	50	
ECA21012	12/24 X 3/8	100	
ECA21016	12/24 X 1/2	100	
ECA21020	12/24 X 5/8	100	
ECA21024	12/24 X 3/4	100	
ECA21032	12/24 X 1	100	
ECA21040	12/24 X 1 1/4	100	
ECA21048	12/24 X 1 1/2	100	
ECA21056	12/24 X 1 3/4	100	
ECA21064	12/24 X 2	100	
ECA04012	1/4-20 X 3/8	100	
ECA04016	1/4-20 X 1/2	100	
ECA04020	1/4-20 X 5/8	100	
ECA04024	1/4-20 X 3/4	100	
ECA04028	1/4-20 X 7/8	100	
ECA04032	1/4-20 X 1	100	
ECA04040	1/4-20 X 1 1/4	100	
ECA04048	1/4-20 X 1 1/2	100	
ECA04056	1/4-20 X 1 3/4	100	
ECA04064	1/4-20 X 2	100	
ECA04080	1/4-20 X 2 1/2	50	
ECA04088X	1/4-20 X 2 3/4	50	
ECA04096	1/4-20 X 3	50	
ECA04112	1/4-20 X 3 1/2	50	
ECA04128	1/4-20 X 4	50	
ECAS04016X	1/4-28 X 1/2	100	
ECAS04020X	1/4-28 X 5/8	100	
ECAS04024X	1/4-28 X 3/4	100	
ECAS04032	1/4-28 X 1	100	
ECAS04040X	1/4-28 X 1 1/4	100	
ECAS04048	1/4-28 X 1 1/2	100	

(continued...)

**SLOTTED FLAT MACHINE SCREW (cont.)**

304 STAINLESS STEEL

Line: 1118-00

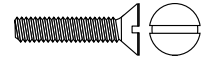

PART NUMBER	SIZE	QTY/BX	LIST PRICE
ECA05016	5/16-18 X 1/2	100	
ECA05020	5/16-18 X 5/8	100	
ECA05024	5/16-18 X 3/4	100	
ECA05028	5/16-18 X 7/8	100	
ECA05032	5/16-18 X 1	100	
ECA05040	5/16-18 X 1 1/4	100	
ECA05048	5/16-18 X 1 1/2	100	
ECA05056	5/16-18 X 1 3/4	50	
ECA05064	5/16-18 X 2	50	
ECA05080	5/16-18 X 2 1/2	50	
ECA05096	5/16-18 X 3	50	
ECA06016	3/8-16 X 1/2	50	
ECA06020	3/8-16 X 5/8	50	
ECA06024	3/8-16 X 3/4	50	
ECA06028	3/8-16 X 7/8	50	
ECA06032	3/8-16 X 1	50	
ECA06040	3/8-16 X 1 1/4	50	
ECA06048	3/8-16 X 1 1/2	50	
ECA06056	3/8-16 X 1 3/4	50	
ECA06064	3/8-16 X 2	50	
ECA06072	3/8-16 X 2 1/4	50	
ECA06080	3/8-16 X 2 1/2	50	
ECA06096	3/8-16 X 3	50	
ECA06112	3/8-16 X 3 1/2	25	
ECA06128	3/8-16 X 4	25	
ECA06160	3/8-16 X 5	25	
ECA08040	1/2-13 X 1 1/4	50	
ECA08048	1/2-13 X 1 1/2	50	
ECA08056	1/2-13 X 1 3/4	25	
ECA08064	1/2-13 X 2	25	
ECA08080	1/2-13 X 2 1/2	25	
ECA08096	1/2-13 X 3	25	
ECA08112	1/2-13 X 3 1/2	25	
ECA08128	1/2-13 X 4	25	
ECA08160	1/2-13 X 5	25	
ECA08192	1/2-13 X 6	25	

**SLOTTED TRUSS MACHINE SCREW**

304 STAINLESS STEEL

Line: 1119-00

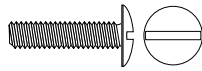

PART NUMBER	SIZE	QTY/BX	LIST PRICE
EDA44008	4/40 X 1/4	100	
EDA44012	4/40 X 3/8	100	
EDA44016	4/40 X 1/2	100	
EDA44020	4/40 X 5/8	100	
EDA44024	4/40 X 3/4	100	
EDA44032	4/40 X 1	100	
EDA66008	6/32 X 1/4	100	
EDA66010X	6/32 X 5/16	100	
EDA66012	6/32 X 3/8	100	
EDA66016	6/32 X 1/2	100	
EDA66020	6/32 X 5/8	100	
EDA66024	6/32 X 3/4	100	
EDA66028	6/32 X 7/8	100	
EDA66032	6/32 X 1	100	
EDA88012	8/32 X 3/8	100	
EDA88016	8/32 X 1/2	100	
EDA88020	8/32 X 5/8	100	
EDA88024	8/32 X 3/4	100	
EDA88028	8/32 X 7/8	100	
EDA88032	8/32 X 1	100	
EDA88040	8/32 X 1 1/4	100	
EDA88048	8/32 X 1 1/2	100	
EDA03008	10/24 X 1/4	100	
EDA03012	10/24 X 3/8	100	
EDA03016	10/24 X 1/2	100	
EDA03020	10/24 X 5/8	100	
EDA03024	10/24 X 3/4	100	
EDA03028	10/24 X 7/8	100	
EDA03032	10/24 X 1	100	
EDA03040	10/24 X 1 1/4	100	
EDA03048	10/24 X 1 1/2	100	
EDA03056	10/24 X 1 3/4	100	
EDA03064	10/24 X 2	100	
EDA03096	10/24 X 3	100	
EDAS03008	10/32 X 1/4	100	
EDAS03012	10/32 X 3/8	100	
EDAS03016	10/32 X 1/2	100	
EDAS03020	10/32 X 5/8	100	
EDAS03024	10/32 X 3/4	100	

(continued...)

**SLOTTED TRUSS MACHINE SCREW (cont.)**

304 STAINLESS STEEL

Line: 1119-00

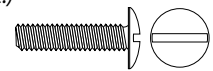

PART NUMBER	SIZE	QTY/BX	LIST PRICE
EDAS03028	10/32 X 7/8	100	
EDAS03032	10/32 X 1	100	
EDAS03040	10/32 X 1 1/4	100	
EDAS03048	10/32 X 1 1/2	100	
EDAS03064	10/32 X 2	100	
EDA04012	1/4-20 X 3/8	100	
EDA04016	1/4-20 X 1/2	100	
EDA04020	1/4-20 X 5/8	100	
EDA04024	1/4-20 X 3/4	100	
EDA04032	1/4-20 X 1	100	
EDA04040	1/4-20 X 1 1/4	100	
EDA04048	1/4-20 X 1 1/2	100	
EDA04056	1/4-20 X 1 3/4	100	
EDA04064	1/4-20 X 2	100	
EDA04080	1/4-20 X 2 1/2	50	
EDA04096	1/4-20 X 3	50	
EDA05024	5/16-18 X 3/4	100	
EDA05032	5/16-18 X 1	100	
EDA05048X	5/16-18 X 1 1/2	100	
EDA06040	3/8-16 X 1 1/4	100	

**SLOTTED PAN MACHINE SCREW**

304 STAINLESS STEEL

Line: 1120-00

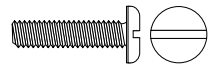

PART NUMBER	SIZE	QTY/BX	LIST PRICE
EEA11006X	1/72 X 3/16	100	
EEA11008X	1/72 X 1/4	100	
EEA22004	2/56 X 1/8	100	
EEA22006	2/56 X 3/16	100	
EEA22008	2/56 X 1/4	100	
EEA22010	2/56 X 5/16	100	
EEA22012	2/56 X 3/8	100	
EEA22016	2/56 X 1/2	100	
EEA22020X	2/56 X 5/8	100	
EEA22024X	2/56 X 3/4	100	
EEA22032X	2/56 X 1	100	
EEA33004	3/48 X 1/8	100	
EEA33006	3/48 X 3/16	100	
EEA33008	3/48 X 1/4	100	
EEA33012	3/48 X 3/8	100	
EEA33016	3/48 X 1/2	100	

(continued...)

**CALL: (800) 723-2826**

**SLOTTED PAN MACHINE SCREW (cont.)**

304 STAINLESS STEEL

Line: 1120-00

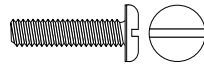

PART NUMBER	SIZE	QTY/BX	LIST PRICE
EEAS33008X	3/56 X 1/4	100	
EEA44004	4/40 X 1/8	100	
EEA44006	4/40 X 3/16	100	
EEA44008	4/40 X 1/4	100	
EEA44010	4/40 X 5/16	100	
EEA44012	4/40 X 3/8	100	
EEA44014X	4/40 X 7/16	100	
EEA44016	4/40 X 1/2	100	
EEA44018	4/40 X 9/16	100	
EEA44020	4/40 X 5/8	100	
EEA44024	4/40 X 3/4	100	
EEA44028	4/40 X 7/8	100	
EEA44032	4/40 X 1	100	
EEA44040	4/40 X 1 1/4	100	
EEA44048	4/40 X 1 1/2	100	
EEA55012	5/40 X 3/8	100	
EEA55016	5/40 X 1/2	100	
EEA55020	5/40 X 5/8	100	
EEA66006	6/32 X 3/16	100	
EEA66008	6/32 X 1/4	100	
EEA66010	6/32 X 5/16	100	
EEA66012	6/32 X 3/8	100	
EEA66014	6/32 X 7/16	100	
EEA66016	6/32 X 1/2	100	
EEA66018	6/32 X 9/16	100	
EEA66020	6/32 X 5/8	100	
EEA66024	6/32 X 3/4	100	
EEA66028	6/32 X 7/8	100	
EEA66032	6/32 X 1	100	
EEA66040	6/32 X 1 1/4	100	
EEA66048	6/32 X 1 1/2	100	
EEA66056	6/32 X 1 3/4	100	
EEA66064X	6/32 X 2	100	
EEAS66012	6/40 X 3/8	100	
EEA88006	8/32 X 3/16	100	
EEA88008	8/32 X 1/4	100	
EEA88010	8/32 X 5/16	100	
EEA88012	8/32 X 3/8	100	
EEA88014X	8/32 X 7/16	100	
EEA88016	8/32 X 1/2	100	

(continued...)

**SLOTTED PAN MACHINE SCREW (cont.)**

304 STAINLESS STEEL

Line: 1120-00

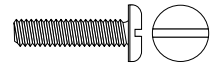

PART NUMBER	SIZE	QTY/BX	LIST PRICE
EEA88020	8/32 X 5/8	100	
EEA88024	8/32 X 3/4	100	
EEA88028	8/32 X 7/8	100	
EEA88032	8/32 X 1	100	
EEA88040	8/32 X 1 1/4	100	
EEA88048	8/32 X 1 1/2	100	
EEA88056	8/32 X 1 3/4	100	
EEA88064	8/32 X 2	100	
EEA03008	10/24 X 1/4	100	
EEA03010	10/24 X 5/16	100	
EEA03012	10/24 X 3/8	100	
EEA03016	10/24 X 1/2	100	
EEA03020	10/24 X 5/8	100	
EEA03024	10/24 X 3/4	100	
EEA03032	10/24 X 1	100	
EEA03040	10/24 X 1 1/4	100	
EEA03048	10/24 X 1 1/2	100	
EEA03056	10/24 X 1 3/4	100	
EEA03064	10/24 X 2	100	
EEAS03008	10/32 X 1/4	100	
EEAS03010	10/32 X 5/16	100	
EEAS03012	10/32 X 3/8	100	
EEAS03014X	10/32 X 7/16	100	
EEAS03016	10/32 X 1/2	100	
EEAS03020	10/32 X 5/8	100	
EEAS03024	10/32 X 3/4	100	
EEAS03028	10/32 X 7/8	100	
EEAS03032	10/32 X 1	100	
EEAS03040	10/32 X 1 1/4	100	
EEAS03048	10/32 X 1 1/2	100	
EEAS03056	10/32 X 1 3/4	100	
EEAS03064	10/32 X 2	100	
EEAS03072X	10/32 X 2 1/4	50	
EEAS03096	10/32 X 3	50	
EEA21012	12/24 X 3/8	100	
EEA21016	12/24 X 1/2	100	
EEA21020	12/24 X 5/8	100	
EEA21024	12/24 X 3/4	100	
EEA21032	12/24 X 1	100	
EEA21048	12/24 X 1 1/2	100	

(continued...)

**SLOTTED PAN MACHINE SCREW (cont.)**

304 STAINLESS STEEL

Line: 1120-00

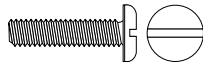

PART NUMBER	SIZE	QTY/BX	LIST PRICE
EEA04012	1/4-20 X 3/8	100	
EEA04016	1/4-20 X 1/2	100	
EEA04020	1/4-20 X 5/8	100	
EEA04024	1/4-20 X 3/4	100	
EEA04032	1/4-20 X 1	100	
EEA04040	1/4-20 X 1 1/4	100	
EEA04048	1/4-20 X 1 1/2	100	
EEA04056	1/4-20 X 1 3/4	100	
EEA04064X	1/4-20 X 2	100	
EEA04096	1/4-20 X 3	100	
EEA05024	5/16-18 X 3/4	50	
EEA06016X	3/8-16 X 1/2	50	

**HEX MACHINE SCREW**

304 STAINLESS STEEL

Line: 1121-00

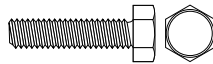

PART NUMBER	SIZE	QTY/BX	LIST PRICE
EFA44012	4/40 X 3/8	100	
EFA44016	4/40 X 1/2	100	
EFA44020	4/40 X 5/8	100	
EFA44024	4/40 X 3/4	100	
EFA66012	6/32 X 3/8	100	
EFA66016	6/32 X 1/2	100	
EFA66020	6/32 X 5/8	100	
EFA66024	6/32 X 3/4	100	
EFA66032	6/32 X 1	100	
EFA88008	8/32 X 1/4	100	
EFA88012	8/32 X 3/8	100	
EFA88016	8/32 X 1/2	100	
EFA88020	8/32 X 5/8	100	
EFA88024	8/32 X 3/4	100	
EFA88028	8/32 X 7/8	100	
EFA88032	8/32 X 1	100	
EFA88040	8/32 X 1 1/4	100	
EFA88048	8/32 X 1 1/2	100	
EFA03008	10/24 X 1/4	100	
EFA03012	10/24 X 3/8	100	
EFA03016	10/24 X 1/2	100	
EFA03020	10/24 X 5/8	100	
EFA03024	10/24 X 3/4	100	
EFA03032	10/24 X 1	100	

(continued...)

**HEX MACHINE SCREW (cont.)**

304 STAINLESS STEEL

Line: 1121-00

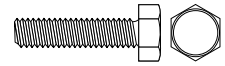

PART NUMBER	SIZE	QTY/BX	LIST PRICE
EFA03040	10/24 X 1 1/4	100	
EFA03048	10/24 X 1 1/2	100	
EFAS03010	10/32 X 5/16	100	
EFAS03012	10/32 X 3/8	100	
EFAS03016	10/32 X 1/2	100	
EFAS03020	10/32 X 5/8	100	
EFAS03024	10/32 X 3/4	100	
EFAS03028	10/32 X 7/8	100	
EFAS03032	10/32 X 1	100	
EFAS03040	10/32 X 1 1/4	100	
EFAS03048	10/32 X 1 1/2	100	
EFAS03064X	10/32 X 2	100	
EFA04014	1/4-20 X 7/16	100	
EFA04024X	1/4-20 X 3/4	100	

**SLOTTED OVAL MACHINE SCREW**

304 STAINLESS STEEL

Line: 1121-01

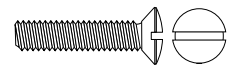

PART NUMBER	SIZE	QTY/BX	LIST PRICE
JVE44012	4/40 X 3/8	100	
JVE44016	4/40 X 1/2	100	
JVE44020	4/40 X 5/8	100	
JVE44024	4/40 X 3/4	100	
JVE66008	6/32 X 1/4 OV	100	
JVE66012	6/32 X 3/8	100	
JVE66016X	6/32 X 1/2	100	
JVE66024X	6/32 X 3/4	100	
JVE66032X	6/32 X 1	100	
JVE66048	6/32 X 1 1/2	100	
JVE88008X	8/32 X 1/4	100	
JVE88016X	8/32 X 1/2	100	
JVE88020X	8/32 X 5/8	100	
JVE88024X	8/32 X 3/4	100	
JVE88032X	8/32 X 1	100	
JVE88040X	8/32 X 1 1/4	100	
JVE88048X	8/32 X 1 1/2	100	
JVE88064X	8/32 X 2	100	
JVE03016X	10/24 X 1/2	100	
JVE03020X	10/24 X 5/8	100	
JVE03024X	10/24 X 3/4	100	
JVE03032X	10/24 X 1	100	

(continued...)

## SLOTTED OVAL MACHINE SCREW (cont.)

304 STAINLESS STEEL

Line: 1121-01

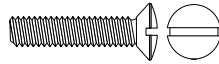

PART NUMBER	SIZE	QTY/BX	LIST PRICE
JVE03048X	10/24 X 1 1/2	100	
JVE03056X	10/24 X 1 3/4	100	
JVE03064	10/24 X 2	100	
JVES03012X	10/32 X 3/8	100	
JVES03016	10/32 X 1/2	100	
JVES03020X	10/32 X 5/8	100	
JVES03024	10/32 X 3/4	100	
JVES03032X	10/32 X 1	100	
JVES03040X	10/32 X 1 1/4	100	
JVES03048X	10/32 X 1 1/2	100	
JVES03064X	10/32 X 2	100	
JVE04016X	1/4-20 X 1/2	100	
JVE04024X	1/4-20 X 3/4	100	
JVE04032X	1/4-20 X 1	100	
JVE04048X	1/4-20 X 1 1/2	100	
JVE04064	1/4-20 X 2	100	
JVE04080X	1/4-20 X 2 1/2	50	
JVE04096X	1/4-20 X 3	50	

## SLOTTED FILLISTER MACHINE SCREW

304 STAINLESS STEEL

Line: 1121-02

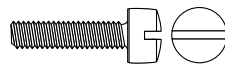

PART NUMBER	SIZE	QTY/BX	LIST PRICE
JEF22004X	2/56 X 1/8	100	
JEF22006X	2/56 X 3/16	100	
JEF22008X	2/56 X 1/4	100	
JEF22010X	2/56 X 5/16	100	
JEF22012X	2/56 X 3/8	100	
JEF22014X	2/56 X 7/16	100	
JEF22016X	2/56 X 1/2	100	
JEF44006X	4/40 X 3/16	100	
JEF44008X	4/40 X 1/4	100	
JEF44010X	4/40 X 5/16	100	
JEF44012X	4/40 X 3/8	100	
JEF44014X	4/40 X 7/16	100	
JEF44016X	4/40 X 1/2	100	
JEF44020X	4/40 X 5/8	100	
JEF44024X	4/40 X 3/4	100	
JEF44028X	4/40 X 7/8	100	
JEF44032X	4/40 X 1	100	
JEF66006X	6/32 X 3/16	100	

(continued...)

## SLOTTED FILLISTER MACHINE SCREW (cont.)

304 STAINLESS STEEL

Line: 1121-02

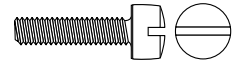

PART NUMBER	SIZE	QTY/BX	LIST PRICE
JEF66008X	6/32 X 1/4	100	
JEF66010X	6/32 X 5/16	100	
JEF66012X	6/32 X 3/8	100	
JEF66014X	6/32 X 7/16	100	
JEF66016X	6/32 X 1/2	100	
JEF66020X	6/32 X 5/8	100	
JEF66024X	6/32 X 3/4	100	
JEF66028X	6/32 X 7/8	100	
JEF66032X	6/32 X 1	100	
JEF66040X	6/32 X 1 1/4	100	
JEF66048X	6/32 X 1 1/2	100	
JEF66064X	6/32 X 2	100	
JEFS66012	6/40 X 3/8	100	
JEF88008X	8/32 X 1/4	100	
JEF88010X	8/32 X 5/16	100	
JEF88012X	8/32 X 3/8	100	
JEF88016X	8/32 X 1/2	100	
JEF88020X	8/32 X 5/8	100	
JEF88024X	8/32 X 3/4	100	
JEF88028X	8/32 X 7/8	100	
JEF88032	8/32 X 1	100	
JEF88040X	8/32 X 1 1/4	100	
JEF88048X	8/32 X 1 1/2	100	
JEF03012X	10/24 X 3/8	100	
JEF03016X	10/24 X 1/2	100	
JEF03020X	10/24 X 5/8	100	
JEF03024X	10/24 X 3/4	100	
JEF03032X	10/24 X 1	100	
JEFS03008X	10/32 X 1/4	100	
JEFS03012X	10/32 X 3/8	100	
JEFS03014X	10/32 X 7/16	100	
JEFS03016X	10/32 X 1/2	100	
JEFS03020X	10/32 X 5/8	100	
JEFS03024X	10/32 X 3/4	100	
JEFS03028X	10/32 X 7/8	100	
JEFS03032X	10/32 X 1	100	
JEFS03040X	10/32 X 1 1/4	100	
JEFS03048	10/32 X 1 1/2	100	
JEF04016X	1/4-20 X 1/2	100	
JEF04024X	1/4-20 X 3/4	100	

(continued...)



**SLOTTED FILLISTER MACHINE SCREW (cont.)**

304 STAINLESS STEEL

Line: 1121-02

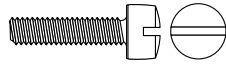

PART NUMBER	SIZE	QTY/BX	LIST PRICE
JEF04028X	1/4-20 X 7/8	100	
JEF04040X	1/4-20 X 1 1/4	100	
JEF04048X	1/4-20 X 1 1/2	100	

**SLOTTED ROUND MACHINE SCREW**

BRASS

Line: 1124-00

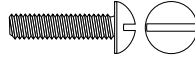

PART NUMBER	SIZE	QTY/BX	LIST PRICE
EJA00006	0/80 X 3/16	100	
EJA00008	0/80 X 1/4	100	
EJA00010X	0/80 X 5/16	100	
EJA00012	0/80 X 3/8	100	
EJA00016	0/80 X 1/2	100	
EJA22006X	2/56 X 3/16	100	
EJA22008	2/56 X 1/4	100	
EJA22010	2/56 X 5/16	100	
EJA22012	2/56 X 3/8	100	
EJA22016	2/56 X 1/2	100	
EJA22020X	2/56 X 5/8	100	
EJA22024	2/56 X 3/4	100	
EJA22032X	2/56 X 1	100	
EJA33004	3/48 X 1/8	100	
EJA33016	3/48 X 1/2	100	
EJA33024	3/48 X 3/4	100	
EJAU44024	4/36 X 3/4	100	
EJA44004	4/40 X 1/8	100	
EJA44006	4/40 X 3/16	100	
EJA44008	4/40 X 1/4	100	
EJA44010	4/40 X 5/16	100	
EJA44012	4/40 X 3/8	100	
EJA44016	4/40 X 1/2	100	
EJA44020	4/40 X 5/8	100	
EJA44024	4/40 X 3/4	100	
EJA44032	4/40 X 1	100	
EJA44036X	4/40 X 1 1/8	100	
EJA44040	4/40 X 1 1/4	100	
EJA44048	4/40 X 1 1/2	100	
EJA55006	5/40 X 3/16	100	
EJA55008	5/40 X 1/4	100	
EJA55012	5/40 X 3/8	100	
EJA55016	5/40 X 1/2	100	

(continued...)

**SLOTTED ROUND MACHINE SCREW (cont.)**

BRASS

Line: 1124-00

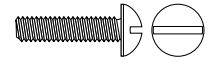

PART NUMBER	SIZE	QTY/BX	LIST PRICE
EJA55024	5/40 X 3/4	100	
EJA55032	5/40 X 1	100	
EJA66004	6/32 X 1/8	100	
EJA66006	6/32 X 3/16	100	
EJA66008	6/32 X 1/4	100	
EJA66010	6/32 X 5/16	100	
EJA66012	6/32 X 3/8	100	
EJA66016	6/32 X 1/2	100	
EJA66020	6/32 X 5/8	100	
EJA66024	6/32 X 3/4	100	
EJA66028	6/32 X 7/8	100	
EJA66032	6/32 X 1	100	
EJA66040	6/32 X 1 1/4	100	
EJA66048	6/32 X 1 1/2	100	
EJA66056	6/32 X 1 3/4	100	
EJA66064	6/32 X 2	100	
EJA66088	6/32 X 2 3/4	100	
EJA66096	6/32 X 3	100	
EJA88006	8/32 X 3/16	100	
EJA88008	8/32 X 1/4	100	
EJA88010	8/32 X 5/16	100	
EJA88012	8/32 X 3/8	100	
EJA88014X	8/32 X 7/16	100	
EJA88016	8/32 X 1/2	100	
EJA88020	8/32 X 5/8	100	
EJA88024	8/32 X 3/4	100	
EJA88028	8/32 X 7/8	100	
EJA88032	8/32 X 1	100	
EJA88040	8/32 X 1 1/4	100	
EJA88048	8/32 X 1 1/2	100	
EJA88056	8/32 X 1 3/4	100	
EJA88064	8/32 X 2	100	
EJA88080	8/32 X 2 1/2	50	
EJA88096	8/32 X 3	50	
EJA03008	10/24 X 1/4	100	
EJA03010	10/24 X 5/16	100	
EJA03012	10/24 X 3/8	100	
EJA03014	10/24 X 7/16	100	
EJA03016	10/24 X 1/2	100	
EJA03020	10/24 X 5/8	100	

(continued...)

**SLOTTED ROUND MACHINE SCREW (cont.)**

BRASS

Line: 1124-00

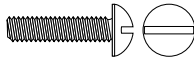

PART NUMBER	SIZE	QTY/BX	LIST PRICE
EJA03024	10/24 X 3/4	100	
EJA03028	10/24 X 7/8	100	
EJA03032	10/24 X 1	100	
EJA03040	10/24 X 1 1/4	100	
EJA03048	10/24 X 1 1/2	100	
EJA03056	10/24 X 1 3/4	100	
EJA03064	10/24 X 2	100	
EJA03072	10/24 X 2 1/4	100	
EJA03080	10/24 X 2 1/2	50	
EJA03096	10/24 X 3	50	
EJAS03006	10/32 X 3/16	100	
EJAS03008	10/32 X 1/4	100	
EJAS03010	10/32 X 5/16	100	
EJAS03012	10/32 X 3/8	100	
EJAS03014	10/32 X 7/16	100	
EJAS03016	10/32 X 1/2	100	
EJAS03020	10/32 X 5/8	100	
EJAS03024	10/32 X 3/4	100	
EJAS03028	10/32 X 7/8	100	
EJAS03032	10/32 X 1	100	
EJAS03040	10/32 X 1 1/4	100	
EJAS03048	10/32 X 1 1/2	100	
EJAS03056	10/32 X 1 3/4	100	
EJAS03064	10/32 X 2	100	
EJAS03080	10/32 X 2 1/2	50	
EJAS03096	10/32 X 3	100	
EJA21008X	12/24 X 1/4	100	
EJA21012	12/24 X 3/8	100	
EJA21016	12/24 X 1/2	100	
EJA21020	12/24 X 5/8	100	
EJA21024	12/24 X 3/4	100	
EJA21028	12/24 X 7/8	100	
EJA21032	12/24 X 1	100	
EJA21040	12/24 X 1 1/4	100	
EJA21048	12/24 X 1 1/2	100	
EJA21064	12/24 X 2	100	
EJA04008	1/4-20 X 1/4	100	
EJA04010	1/4-20 X 5/16	100	
EJA04012	1/4-20 X 3/8	100	
EJA04016	1/4-20 X 1/2	100	

(continued...)

**SLOTTED ROUND MACHINE SCREW (cont.)**

BRASS

Line: 1124-00

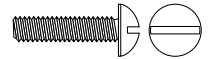

PART NUMBER	SIZE	QTY/BX	LIST PRICE
EJA04020	1/4-20 X 5/8	100	
EJA04024	1/4-20 X 3/4	100	
EJA04028	1/4-20 X 7/8	100	
EJA04032	1/4-20 X 1	100	
EJA04040	1/4-20 X 1 1/4	100	
EJA04048	1/4-20 X 1 1/2	100	
EJA04056	1/4-20 X 1 3/4	100	
EJA04064	1/4-20 X 2	100	
EJA04072	1/4-20 X 2 1/4	50	
EJA04080	1/4-20 X 2 1/2	50	
EJA04088	1/4-20 X 2 3/4	50	
EJA04096	1/4-20 X 3	50	
EJA04112	1/4-20 X 3 1/2	50	
EJA04128	1/4-20 X 4	50	
EJA05016	5/16-18 X 1/2	100	
EJA05020	5/16-18 X 5/8	100	
EJA05024	5/16-18 X 3/4	100	
EJA05032	5/16-18 X 1	100	
EJA05040	5/16-18 X 1 1/4	50	
EJA05048	5/16-18 X 1 1/2	50	
EJA05056	5/16-18 X 1 3/4	50	
EJA05064	5/16-18 X 2	50	
EJA05080	5/16-18 X 2 1/2	50	
EJA05096	5/16-18 X 3	50	
EJA06016	3/8-16 X 1/2	50	
EJA06024	3/8-16 X 3/4	50	
EJA06024C	3/8-16 X 3/4	100	
EJA06032	3/8-16 X 1	50	
EJA06040	3/8-16 X 1 1/4	50	
EJA06048	3/8-16 X 1 1/2	50	
EJA06056	3/8-16 X 1 3/4	50	
EJA06064	3/8-16 X 2	50	
EJA06080	3/8-16 X 2 1/2	50	
EJA06096	3/8-16 X 3	50	
EJA06160X	3/8-16 X 5	25	

**SLOTTED FLAT MACHINE SCREW**

BRASS

Line: 1125-00

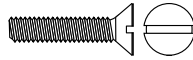

PART NUMBER	SIZE	QTY/BX	LIST PRICE
EKA00006X	0/80 X 3/16	100	
EKA00010	0/80 X 5/16	100	
EKA00012	0/80 X 3/8	100	
EKA00014X	0/80 X 7/16	100	
EKA00020X	0/80 X 5/8	100	
EKA00024X	0/80 X 3/4	100	
EKA00032X	0/80 X 1	100	
EKA11006X	1/72 X 3/16	100	
EKA11010	1/72 X 5/16	100	
EKA11012	1/72 X 3/8	100	
EKA11014X	1/72 X 7/16	100	
EKA11020X	1/72 X 5/8	100	
EKA11024X	1/72 X 3/4	100	
EKA11032X	1/72 X 1	100	
EKA22004X	2/56 X 1/8	100	
EKA22006X	2/56 X 3/16	100	
EKA22008	2/56 X 1/4	100	
EKA22010	2/56 X 5/16	100	
EKA22012	2/56 X 3/8	100	
EKA22014X	2/56 X 7/16	100	
EKA22016	2/56 X 1/2	100	
EKA22020	2/56 X 5/8	100	
EKA33032	3/48 X 1	100	
EKAU44008NP	4/36 X 1/4 (NICKEL PLATED)	100	
EKAU44012NP	4/36 X 3/8 (NICKEL PLATED)	100	
EKA44004	4/40 X 1/8	100	
EKA44006X	4/40 X 3/16	100	
EKA44008	4/40 X 1/4	100	
EKA44010	4/40 X 5/16	100	
EKA44012	4/40 X 3/8	100	
EKA44014X	4/40 X 7/16	100	
EKA44016	4/40 X 1/2	100	
EKA44020	4/40 X 5/8	100	
EKA44024	4/40 X 3/4	100	
EKA44028	4/40 X 7/8	100	
EKA44032	4/40 X 1	100	
EKA44036X	4/40 X 1 1/8	100	
EKA44040	4/40 X 1 1/4	100	
EKA44048	4/40 X 1 1/2	100	
EKA55008	5/40 X 1/4	100	

(continued...)

**SLOTTED FLAT MACHINE SCREW (cont.)**

BRASS

Line: 1125-00

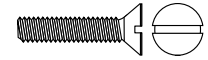

PART NUMBER	SIZE	QTY/BX	LIST PRICE
EKA55012	5/40 X 3/8	100	
EKA55016	5/40 X 1/2	100	
EKA55020	5/40 X 5/8	100	
EKA55024	5/40 X 3/4	100	
EKA55032	5/40 X 1	100	
EKA55040	5/40 X 1 1/4	100	
EKA55048	5/40 X 1 1/2	100	
EKA66006X	6/32 X 3/16	100	
EKA66008	6/32 X 1/4	100	
EKA66010	6/32 X 5/16	100	
EKA66012	6/32 X 3/8	100	
EKA66016	6/32 X 1/2	100	
EKA66020	6/32 X 5/8	100	
EKA66024	6/32 X 3/4	100	
EKA66028	6/32 X 7/8	100	
EKA66032	6/32 X 1	100	
EKA66040	6/32 X 1 1/4	100	
EKA66048	6/32 X 1 1/2	100	
EKA66064	6/32 X 2	100	
EKA88008	8/32 X 1/4	100	
EKA88010	8/32 X 5/16	100	
EKA88012	8/32 X 3/8	100	
EKA88014X	8/32 X 7/16	100	
EKA88016	8/32 X 1/2	100	
EKA88020	8/32 X 5/8	100	
EKA88024	8/32 X 3/4	100	
EKA88028	8/32 X 7/8	100	
EKA88032	8/32 X 1	100	
EKA88040	8/32 X 1 1/4	100	
EKA88048	8/32 X 1 1/2	100	
EKA88056X	8/32 X 1 3/4	100	
EKA88064	8/32 X 2	100	
EKA88080	8/32 X 2 1/2	50	
EKA88096	8/32 X 3	50	
EKA03008	10/24 X 1/4	100	
EKA03010	10/24 X 5/16	100	
EKA03012	10/24 X 3/8	100	
EKA03016	10/24 X 1/2	100	
EKA03020	10/24 X 5/8	100	
EKA03024	10/24 X 3/4	100	

(continued...)

**CALL: (800) 723-2826**

## SLOTTED FLAT MACHINE SCREW (cont.)

BRASS

Line: 1125-00

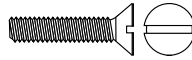

PART NUMBER	SIZE	QTY/BX	LIST PRICE
EKA03028	10/24 X 7/8	100	
EKA03032	10/24 X 1	100	
EKA03040	10/24 X 1 1/4	100	
EKA03048	10/24 X 1 1/2	100	
EKA03056	10/24 X 1 3/4	100	
EKA03064	10/24 X 2	100	
EKA03080	10/24 X 2 1/2	50	
EKA03096	10/24 X 3	50	
EKA03008	10/32 X 1/4	100	
EKA03010	10/32 X 5/16	100	
EKA03012	10/32 X 3/8	100	
EKA03016	10/32 X 1/2	100	
EKA03020	10/32 X 5/8	100	
EKA03024	10/32 X 3/4	100	
EKA03028	10/32 X 7/8	100	
EKA03032	10/32 X 1	100	
EKA03040	10/32 X 1 1/4	100	
EKA03048	10/32 X 1 1/2	100	
EKA03056	10/32 X 1 3/4	100	
EKA03064	10/32 X 2	100	
EKA03080	10/32 X 2 1/2	50	
EKA03096	10/32 X 3	50	
EKA21012	12/24 X 3/8	100	
EKA21016	12/24 X 1/2	100	
EKA21020	12/24 X 5/8	100	
EKA21024	12/24 X 3/4	100	
EKA21032	12/24 X 1	100	
EKA21040	12/24 X 1 1/4	100	
EKA21048	12/24 X 1 1/2	100	
EKA21064	12/24 X 2	100	
EKA04012	1/4-20 X 3/8	100	
EKA04016	1/4-20 X 1/2	100	
EKA04020	1/4-20 X 5/8	100	
EKA04024	1/4-20 X 3/4	100	
EKA04028	1/4-20 X 7/8	100	
EKA04032	1/4-20 X 1	100	
EKA04040	1/4-20 X 1 1/4	100	
EKA04048	1/4-20 X 1 1/2	100	
EKA04056	1/4-20 X 1 3/4	100	
EKA04064	1/4-20 X 2	100	

(continued...)

## SLOTTED FLAT MACHINE SCREW (cont.)

BRASS

Line: 1125-00

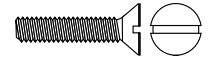

PART NUMBER	SIZE	QTY/BX	LIST PRICE
EKA04080	1/4-20 X 2 1/2	50	
EKA04096	1/4-20 X 3	50	
EKA04112	1/4-20 X 3 1/2	50	
EKA04128	1/4-20 X 4	50	
EKA04016	1/4-28 X 1/2	100	
EKA05016	5/16-18 X 1/2	100	
EKA05016UNDC	5/16-18 X 1/2 UNDCUT	100	
EKA05020	5/16-18 X 5/8	100	
EKA05024	5/16-18 X 3/4	100	
EKA05028	5/16-18 X 7/8	100	
EKA05032	5/16-18 X 1	100	
EKA05040	5/16-18 X 1 1/4	100	
EKA05048	5/16-18 X 1 1/2	100	
EKA05056	5/16-18 X 1 3/4	50	
EKA05064	5/16-18 X 2	50	
EKA05080	5/16-18 X 2 1/2	50	
EKA05096	5/16-18 X 3	50	
EKA06016	3/8-16 X 1/2	50	
EKA06024	3/8-16 X 3/4	50	
EKA06032	3/8-16 X 1	50	
EKA06040	3/8-16 X 1 1/4	50	
EKA06048	3/8-16 X 1 1/2	50	
EKA06056	3/8-16 X 1 3/4	50	
EKA06064	3/8-16 X 2	50	
EKA06080	3/8-16 X 2 1/2	50	
EKA06096	3/8-16 X 3	50	
EKA08032	1/2-13 X 1	50	
EKA08040	1/2-13 X 1 1/4	50	
EKA08048	1/2-13 X 1 1/2	50	
EKA08056	1/2-13 X 1 3/4	50	
EKA08064	1/2-13 X 2	50	
EKA08080	1/2-13 X 2 1/2	50	
EKA08096	1/2-13 X 3	50	

**SLOT BINDING HD. MACHINE SCREW**

BRASS

Line: 1126-00

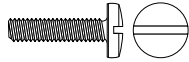

PART NUMBER	SIZE	QTY/BX	LIST PRICE
ELA44006X	4/40 X 3/16	100	
ELA44008	4/40 X 1/4	100	
ELA44010	4/40 X 5/16	100	
ELA44012	4/40 X 3/8	100	
ELA44014X	4/40 X 7/16	100	
ELA44016	4/40 X 1/2	100	
ELA44020	4/40 X 5/8	100	
ELA44024	4/40 X 3/4	100	
ELA66004	6/32 X 1/8	100	
ELA66006	6/32 X 3/16	100	
ELA66008	6/32 X 1/4	100	
ELA66010	6/32 X 5/16	100	
ELA66012	6/32 X 3/8	100	
ELA66016	6/32 X 1/2	100	
ELA66020	6/32 X 5/8	100	
ELA66024	6/32 X 3/4	100	
ELA66028	6/32 X 7/8	100	
ELA66032	6/32 X 1	100	
ELA66040	6/32 X 1 1/4	100	
ELA66048	6/32 X 1 1/2	100	
ELA88008	8/32 X 1/4	100	
ELA88010	8/32 X 5/16	100	
ELA88012	8/32 X 3/8	100	
ELA88016	8/32 X 1/2	100	
ELA88020	8/32 X 5/8	100	
ELA88024	8/32 X 3/4	100	
ELA88028	8/32 X 7/8	100	
ELA88032	8/32 X 1	100	
ELA88040	8/32 X 1 1/4	100	
ELA03008	10/24 X 1/4	100	
ELA03012	10/24 X 3/8	100	
ELA03016	10/24 X 1/2	100	
ELA03020	10/24 X 5/8	100	
ELA03024	10/24 X 3/4	100	
ELA03028	10/24 X 7/8	100	
ELA03032	10/24 X 1	100	
ELA03040	10/24 X 1 1/4	100	
ELA03048	10/24 X 1 1/2	100	
ELAS03008	10/32 X 1/4	100	

(continued...)

**SLOT BINDING HD. MACHINE SCREW (cont.)**

BRASS

Line: 1126-00

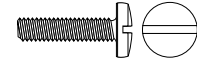

PART NUMBER	SIZE	QTY/BX	LIST PRICE
ELAS03010X	10/32 X 5/16	100	
ELAS03012	10/32 X 3/8	100	
ELAS03016	10/32 X 1/2	100	
ELAS03020	10/32 X 5/8	100	
ELAS03024	10/32 X 3/4	100	
ELAS03032	10/32 X 1	100	
ELAS03040	10/32 X 1 1/4	100	
ELAS03048	10/32 X 1 1/2	100	
ELA04012	1/4-20 X 3/8	100	
ELA04016	1/4-20 X 1/2	100	
ELA04020	1/4-20 X 5/8	100	
ELA04024	1/4-20 X 3/4	100	
ELA04028	1/4-20 X 7/8	100	
ELA04032	1/4-20 X 1	100	
ELA04040	1/4-20 X 1 1/4	100	
ELA04048	1/4-20 X 1 1/2	100	
ELA04064	1/4-20 X 2	100	



**CALL - 1 (800) 723-2826**

**CALL: (800) 723-2826**

**SLOT FILLISTER HD. MACHINE SCREW**

BRASS

Line: 1127-00

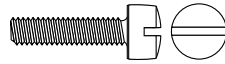

PART NUMBER	SIZE	QTY/BX	LIST PRICE
EMA44006	4/40 X 3/16	100	
EMA44008	4/40 X 1/4	100	
EMA44010	4/40 X 5/16	100	
EMA44012	4/40 X 3/8	100	
EMA44016	4/40 X 1/2	100	
EMA44020	4/40 X 5/8	100	
EMA44024	4/40 X 3/4	100	
EMA44032	4/40 X 1	100	
EMA66004	6/32 X 1/8	100	
EMA66006	6/32 X 3/16	100	
EMA66008	6/32 X 1/4	100	
EMA66010	6/32 X 5/16	100	
EMA66012	6/32 X 3/8	100	
EMA66016	6/32 X 1/2	100	
EMA66020	6/32 X 5/8	100	
EMA66024	6/32 X 3/4	100	
EMA66028	6/32 X 7/8	100	
EMA66032	6/32 X 1	100	
EMA66040	6/32 X 1 1/4	100	
EMA66048	6/32 X 1 1/2	100	
EMA66064	6/32 X 2	100	
EMA88008	8/32 X 1/4	100	
EMA88010	8/32 X 5/16	100	
EMA88012	8/32 X 3/8	100	
EMA88016	8/32 X 1/2	100	
EMA88020	8/32 X 5/8	100	
EMA88024	8/32 X 3/4	100	
EMA88028	8/32 X 7/8	100	
EMA88032	8/32 X 1	100	
EMA88040	8/32 X 1 1/4	100	
EMA88048	8/32 X 1 1/2	100	
EMA03008	10/24 X 1/4	100	
EMA03010	10/24 X 5/16	100	
EMA03012	10/24 X 3/8	100	
EMA03016	10/24 X 1/2	100	
EMA03020	10/24 X 5/8	100	
EMA03024	10/24 X 3/4	100	
EMA03028	10/24 X 7/8	100	
EMA03032	10/24 X 1	100	
EMA03040	10/24 X 1 1/4	100	

(continued...)

**SLOT FILLISTER HD. MACHINE SCREW (cont.)**

BRASS

Line: 1127-00

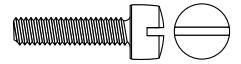

PART NUMBER	SIZE	QTY/BX	LIST PRICE
EMA03048	10/24 X 1 1/2	100	
EMA03056	10/24 X 1 3/4	100	
EMA03064	10/24 X 2	100	
EMAS03006	10/32 X 3/16	100	
EMAS03008	10/32 X 1/4	100	
EMAS03012	10/32 X 3/8	100	
EMAS03016	10/32 X 1/2	100	
EMAS03020	10/32 X 5/8	100	
EMAS03024	10/32 X 3/4	100	
EMAS03028	10/32 X 7/8	100	
EMAS03032	10/32 X 1	100	
EMAS03040	10/32 X 1 1/4	100	
EMAS03048	10/32 X 1 1/2	100	
EMAS03056	10/32 X 1 3/4	100	
EMAS03064	10/32 X 2	100	
EMA04012	1/4-20 X 3/8	100	
EMA04016	1/4-20 X 1/2	100	
EMA04020	1/4-20 X 5/8	100	
EMA04024	1/4-20 X 3/4	100	
EMA04028	1/4-20 X 7/8	100	
EMA04032	1/4-20 X 1	100	
EMA04040	1/4-20 X 1 1/4	100	
EMA04048	1/4-20 X 1 1/2	100	
EMA04056	1/4-20 X 1 3/4	100	
EMA04064	1/4-20 X 2	100	
EMA05024	5/16-18 X 3/4	100	
EMA05028	5/16-18 X 7/8	100	
EMA05032	5/16-18 X 1	100	

**SLOTTED ROUND MACHINE SCREW**

ALUMINUM  
Line: 1127-01

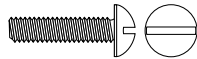

PART NUMBER	SIZE	QTY/BX	LIST PRICE
JZE88032	8/32 X 1	100	
JZE03032	10/24 X 1	100	
JZES03024	10/32 X 3/4	100	
JZES03032	10/32 X 1	100	
JZES03040	10/32 X 1 1/4	100	
JZE04016X	1/4-20 X 1/2	100	
JZE04020	1/4-20 X 5/8	100	
JZE04024	1/4-20 X 3/4	100	
JZE04040	1/4-20 X 1 1/4	100	
JZE04064	1/4-20 X 2	100	

**SLOTTED FLAT MACHINE SCREW**

ALUMINUM  
Line: 1127-02

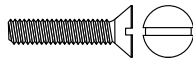

PART NUMBER	SIZE	QTY/BX	LIST PRICE
JAF03016X	10/24 X 1/2	100	
JAFS03016X	10/32 X 1/2	100	
JAF04012X	1/4 X 3/8	100	
JAF04010X	1/4-20 X 5/16	100	
JAF04040X	1/4-20 X 1 1/4	100	
JAF04048X	1/4-20 X 1 1/2	100	
JAF04064X	1/4-20 X 2	50	

**PHILLIPS FLAT MACHINE SCREW**

304 STAINLESS STEEL  
Line: 1127-03

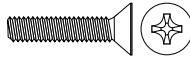

PART NUMBER	SIZE	QTY/BX	LIST PRICE
JJF88020	8-32 X 5/8	100	
JJF22004	2/56 X 1/8	100	
JJF22008	2/56 X 1/4	100	
JJF22010	2/56 X 5/16	100	
JJF22012	2/56 X 3/8	100	
JJF22016	2/56 X 1/2	100	
JJF22032	2/56 X 1	100	
JJF44006	4/40 X 3/16	100	
JJF44008	4/40 X 1/4	100	
JJF44010	4/40 X 5/16	100	
JJF44012	4/40 X 3/8	100	
JJF44016	4/40 X 1/2	100	
JJF44020	4/40 X 5/8	100	
JJF44024	4/40 X 3/4	100	
JJF44028	4/40 X 7/8	100	

(continued...)

**PHILLIPS FLAT MACHINE SCREW (cont.)**

304 STAINLESS STEEL  
Line: 1127-03

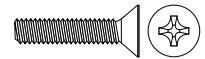

PART NUMBER	SIZE	QTY/BX	LIST PRICE
JJF44032	4/40 X 1	100	
JJF44040	4/40 X 1 1/4	100	
JJF44048	4/40 X 1 1/2	100	
JJF66006	6/32 X 3/16	100	
JJF66008X	6/32 X 1/4	100	
JJF66010	6/32 X 5/16	100	
JJF66012	6/32 X 3/8	100	
JJF66016	6/32 X 1/2	100	
JJF66020	6/32 X 5/8	100	
JJF66024	6/32 X 3/4	100	
JJF66028	6/32 X 7/8	100	
JJF66032	6/32 X 1	100	
JJF66032BLK	6/32 X 1 (BLACK OXIDE)	100	
JJF66040	6/32 X 1 1/4	100	
JJF66048	6/32 X 1 1/2	100	
JJF88008X	8/32 X 1/4 (UNDERCUT)	100	
JJF88010	8/32 X 5/16	100	
JJF88012	8/32 X 3/8	100	
JJF88016X	8/32 X 1/2	100	
JJF88024	8/32 X 3/4	100	
JJF88028	8/32 X 7/8	100	
JJF88032	8/32 X 1	100	
JJF88032BLK	8/32 X 1 (BLACK OXIDE)	100	
JJF88040X	8/32 X 1 1/4	100	
JJF88048	8/32 X 1 1/2	100	
JJF88056	8/32 X 1 3/4	100	
JJF88064	8/32 X 2	100	
JJF88080	8/32 X 2 1/2	100	
JJF88096	8/32 X 3	100	
JJF03008	10/24 X 1/4	100	
JJF03010	10/24 X 5/16	100	
JJF03012	10/24 X 3/8	100	
JJF03016	10/24 X 1/2	100	
JJF03020	10/24 X 5/8	100	
JJF03024	10/24 X 3/4	100	
JJF03032	10/24 X 1	100	
JJF03040	10/24 X 1 1/4	100	
JJF03048	10/24 X 1 1/2	100	
JJF03064	10/24 X 2	100	
JJF03080	10/24 X 2 1/2	100	

(continued...)

**PHILLIPS FLAT MACHINE SCREW (cont.)**

304 STAINLESS STEEL

Line: 1127-03

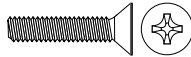

PART NUMBER	SIZE	QTY/BX	LIST PRICE
JJF03096	10/24 X 3	100	
JJF03112	10/24 X 3 1/2	100	
JJFS03008	10/32 X 1/4	100	
JJFS03010	10/32 X 5/16	100	
JJFS03012	10/32 X 3/8	100	
JJFS03016X	10/32 X 1/2	100	
JJFS03020X	10/32 X 5/8	100	
JJFS03024	10/32 X 3/4	100	
JJFS03028	10/32 X 7/8	100	
JJFS03032	10/32 X 1	100	
JJFS03032BLK	10/32 X 1 (BLACK OXIDE)	100	
JJFS03040	10/32 X 1 1/4	100	
JJFS03048	10/32 X 1 1/2	100	
JJFS03056	10/32 X 1 3/4	100	
JJFS03064	10/32 X 2	100	
JJFS03080	10/32 X 2 1/2	100	
JJFS03096	10/32 X 3	100	
JJF21016	12/24 X 1/2	100	
JJF21016UC	12/24 X 1/2 (UNDERCUT)	100	
JJF21024	12/24 X 3/4	100	
JJF21032	12/24 X 1	100	
JJF21048	12/24 X 1 1/2	100	
JJF04016	1/4-20 X 1/2	100	
JJF04020	1/4-20 X 5/8	100	
JJF04024	1/4-20 X 3/4	100	
JJF04028	1/4-20 X 7/8	100	
JJF04032	1/4-20 X 1	100	
JJF04040	1/4-20 X 1 1/4	100	
JJF04048	1/4-20 X 1 1/2	100	
JJF04056	1/4-20 X 1 3/4	100	
JJF04064	1/4-20 X 2	100	
JJF04072	1/4-20 X 2 1/4	100	
JJF04080	1/4-20 X 2 1/2	100	
JJF04096	1/4-20 X 3	100	
JJF04112	1/4-20 X 3 1/2	50	
JJF04128	1/4-20 X 4	50	
JJF04160	1/4-20 X 5	50	
JJF05020	5/16-18 X 5/8	100	
JJF05024	5/16-18 X 3/4	100	
JJF05032	5/16-18 X 1	100	

(continued...)

**PHILLIPS FLAT MACHINE SCREW (cont.)**

304 STAINLESS STEEL

Line: 1127-03

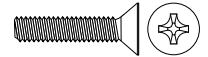

PART NUMBER	SIZE	QTY/BX	LIST PRICE
JJF05040	5/16-18 X 1 1/4	100	
JJF05048	5/16-18 X 1 1/2	100	
JJF05056	5/16-18 X 1 3/4	100	
JJF05064	5/16-18 X 2	100	
JJF05080	5/16-18 X 2 1/2	100	
JJF05096	5/16-18 X 3	100	
JJF05112	5/16-18 X 3 1/2	50	
JJF05128	5/16-18 X 4	50	
JJF05160	5/16-18 X 5	50	
JJF06032	3/8-16 X 1	100	
JJF06040	3/8-16 X 1 1/4	100	
JJF06048	3/8-16 X 1 1/2	100	
JJF06064	3/8-16 X 2	50	
JJF06080	3/8-16 X 2 1/2	50	
JJF06096	3/8-16 X 3	50	
JJF06112	3/8-16 X 3 1/2	25	
JJF06128	3/8-16 X 4	25	



**PHILLIPS TRUSS MACHINE SCREW**

304 STAINLESS STEEL

Line: 1127-04

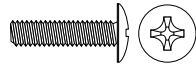

PART NUMBER	SIZE	QTY/BX	LIST PRICE
JKF44012	4/40 X 3/8	100	
JKF44016	4/40 X 1/2	100	
JKF66008	6/32 X 1/4	100	
JKF66012X	6/32 X 3/8	100	
JKF66016	6/32 X 1/2	100	
JKF66020	6/32 X 5/8	100	
JKF66024	6/32 X 3/4	100	
JKF66032	6/32 X 1	100	
JKF66040	6/32 X 1 1/4	100	
JKF66048	6/32 X 1 1/2	100	
JKF88012	8/32 X 3/8	100	
JKF88016	8/32 X 1/2	100	
JKF88020	8/32 X 5/8	100	
JKF88024	8/32 X 3/4	100	
JKF88032	8/32 X 1	100	
JKF88048	8/32 X 1 1/2	100	
JKF03016	10/24 X 1/2	100	
JKF03024	10/24 X 3/4	100	
JKF03032	10/24X 1	100	
JKF03048	10/24 X 1 1/2	100	
JKF503008	10/32 X 1/4	100	
JKF503020X	10/32 X 5/8	100	
JKF503024	10/32 X 3/4	100	
JKF503032	10/32 X 1	100	
JKF503064X	10/32 X 2	100	
JKF21016	12/24 X 1/2	100	
JKF04020	1/4-20 X 5/8	100	
JKF04028	1/4-20 X 7/8	100	
JKF04032	1/4-20 X 1	100	
JKF04040	1/4-20 X 1 1/4	100	
JKF04048	1/4-20 X 1 1/2	100	
JKF04056	1/4-20 X 1 3/4	100	
JKF04064	1/4-20 X 2	100	
JKF05024	5/16-18 X 3/4	100	

**PHILLIPS PAN MACHINE SCREW**

304 STAINLESS STEEL

Line: 1127-05

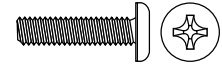

PART NUMBER	SIZE	QTY/BX	LIST PRICE
JLF22004	2/56 X 1/8	100	
JLF22006	2/56 X 3/16	100	
JLF22008	2/56 X 1/4	100	
JLF22012	2/56 X 3/8	100	
JLF22016	2/56 X 1/2	100	
JLF22024	2/56 X 3/4	100	
JLF44004	4/40 X 1/8	100	
JLF44006X	4/40 X 3/16	100	
JLF44008	4/40 X 1/4	100	
JLF44010	4/40 X 5/16	100	
JLF44012	4/40 X 3/8	100	
JLF44016	4/40 X 1/2	100	
JLF44020	4/40 X 5/8	100	
JLF44024	4/40 X 3/4	100	
JLF44028	4/40 X 7/8	100	
JLF44032	4/40 X 1	100	
JLF44040	4/40 X 1 1/4	100	
JLF44048	4/40 X 1 1/2	100	
JLF55008	5/40 X 1/4	100	
JLF66006	6/32 X 3/16	100	
JLF66008	6/32 X 1/4	100	
JLF66010	6/32 X 5/16	100	
JLF66012	6/32 X 3/8	100	
JLF66012BLK	6/32 X 3/8 (BLACK ZINC)	300	
JLF66016	6/32 X 1/2	100	
JLF66020	6/32 X 5/8	100	
JLF66024	6/32 X 3/4	100	
JLF66028	6/32 X 7/8	100	
JLF66032X	6/32 X 1	100	
JLF66040	6/32 X 1 1/4	100	
JLF66048	6/32 X 1 1/2	100	
JLF66056	6/32 X 1 3/4	100	
JLF66064	6/32 X 2	100	
JLF88008	8/32 X 1/4	100	
JLF88010	8/32 X 5/16	100	
JLF88012	8/32 X 3/8	100	
JLF88016	8/32 X 1/2	100	
JLF88020	8/32 X 5/8	100	
JLF88024	8/32 X 3/4	100	
JLF88028	8/32 X 7/8	100	

(continued...)

**CALL: (800) 723-2826**

**PHILLIPS PAN MACHINE SCREW (cont.)**

304 STAINLESS STEEL

Line: 1127-05

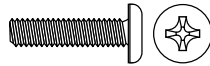

PART NUMBER	SIZE	QTY/BX	LIST PRICE
JLF88032	8/32 X 1	100	
JLF88040	8/32 X 1 1/4	100	
JLF88048	8/32 X 1 1/2	100	
JLF88056	8/32 X 1 3/4	100	
JLF88064	8/32 X 2	100	
JLF88080	8/32 X 2 1/2	100	
JLF03008	10/24 X 1/4	100	
JLF03010	10/24 X 5/16	100	
JLF03012	10/24 X 3/8	100	
JLF03016	10/24 X 1/2	100	
JLF03020	10/24 X 5/8	100	
JLF03024	10/24 X 3/4	100	
JLF03028	10/24 X 7/8	100	
JLF03032	10/24 X 1	100	
JLF03040	10/24 X 1 1/4	100	
JLF03048	10/24 X 1 1/2	100	
JLF03056	10/24 X 1 3/4	100	
JLF03064	10/24 X 2	100	
JLF03072	10/24 X 2 1/4	100	
JLF03080	10/24 X 2 1/2	100	
JLF03096	10/24 X 3	50	
JLFS03008	10/32 X 1/4	100	
JLFS03010	10/32 X 5/16	100	
JLFS03012	10/32 X 3/8	100	
JLFS03016X	10/32 X 1/2	100	
JLFS03020	10/32 X 5/8	100	
JLFS03024	10/32 X 3/4	100	
JLFS03028	10/32 X 7/8	100	
JLFS03032	10/32 X 1	100	
JLFS03040X	10/32 X 1 1/4	100	
JLFS03048	10/32 X 1 1/2	100	
JLFS03056	10/32 X 1 3/4	100	
JLFS03064	10/32 X 2	100	
JLFS03080	10/32 X 2 1/2	100	
JLFS03096	10/32 X 3	50	
JLF21016	12/24 X 1/2	100	
JLF21024	12/24 X 3/4	100	
JLF21032	12/24 X 1	100	
JLF21048	12/24 X 1 1/2	100	
JLF04012	1/4-20 X 3/8	100	

(continued...)

**PHILLIPS PAN MACHINE SCREW (cont.)**

304 STAINLESS STEEL

Line: 1127-05

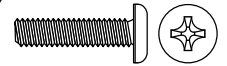

PART NUMBER	SIZE	QTY/BX	LIST PRICE
JLF04016	1/4-20 X 1/2	100	
JLF04020	1/4-20 X 5/8	100	
JLF04024	1/4-20 X 3/4	100	
JLF04028	1/4-20 X 7/8	100	
JLF04032	1/4-20 X 1	100	
JLF04040	1/4-20 X 1 1/4	100	
JLF04048	1/4-20 X 1 1/2	100	
JLF04056	1/4-20 X 1 3/4	100	
JLF04064	1/4-20 X 2	100	
JLF04072	1/4-20 X 2 1/4	100	
JLF04080	1/4-20 X 2 1/2	50	
JLF04096	1/4-20 X 3	50	
JLF04112	1/4-20 X 3 1/2	50	
JLF04128	1/4-20 X 4	50	
JLF05016X	5/16-18 X 1/2	100	
JLF05020	5/16-18 X 5/8	100	
JLF05024X	5/16-18 X 3/4	100	
JLF05032	5/16-18 X 1	100	
JLF05040	5/16-18 X 1 1/4	100	
JLF05048	5/16-18 X 1 1/2	100	
JLF05064	5/16-18 X 2	50	
JLF05080	5/16-18 X 2 1/2	50	
JLFS05020	5/16-24 X 5/8	100	
JLF06032	3/8-16 X 1	50	

**PHILLIPS OVAL MACHINE SCREW**

304 STAINLESS STEEL

Line: 1127-06

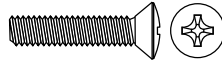

PART NUMBER	SIZE	QTY/BX	LIST PRICE
JMF03080	10-24 X 2 1/2	100	
JMF03096	10-24 X 3	100	
JMF66008	6/32 X 1/4	100	
JMF66008BLK	6/32 X 1/4 BLK/ZINC	500	
JMF66012	6/32 X 3/8	100	
JMF66016	6/32 X 1/2	100	
JMF66020X	6/32 X 5/8	100	
JMF66024	6/32 X 3/4	100	
JMF66028	6/32 X 7/8	100	
JMF66032	6/32 X 1	100	
JMF66040	6/32 X 1 1/4	100	
JMF66048	6/32 X 1 1/2	100	
JMF66056	6/32 X 1 3/4	100	
JMF66064	6/32 X 2	100	
JMF88012	8/32 X 3/8	100	
JMF88016	8/32 X 1/2	100	
JMF88020X	8/32 X 5/8	100	
JMF88024	8/32 X 3/4	100	
JMF88028	8/32 X 7/8	100	
JMF88032	8/32 X 1	100	
JMF88040	8/32 X 1 1/4	100	
JMF88048	8/32 X 1 1/2	100	
JMF88048BLK	8/32 X 1 1/2 (BLACK ZINC)	100	
JMF88056	8/32 X 1 3/4	100	
JMF88064	8/32 X 2	100	
JMF88080	8/32 X 2 1/2	100	
JMF03012	10/24 X 3/8	100	
JMF03016	10/24 X 1/2	100	
JMF03020	10/24 X 5/8	100	
JMF03024	10/24 X 3/4	100	
JMF03028	10/24 X 7/8	100	
JMF03032	10/24 X 1	100	
JMF03040	10/24 X 1 1/4	100	
JMF03048	10/24 X 1 1/2	100	
JMF03056	10/24 X 1 3/4	100	
JMF03064	10/24 X 2	100	
JMF03064BLK	10/24X 2 (BLACK ZINC)	100	
JMF03096BLK	10/24X 3 (BLACK ZINC)	100	
JMF03128	10/24 X 4	100	
JMFS03012	10/32 X 3/8	100	

(continued...)

**PHILLIPS OVAL MACHINE SCREW (cont.)**

304 STAINLESS STEEL

Line: 1127-06

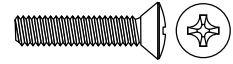

PART NUMBER	SIZE	QTY/BX	LIST PRICE
JMFS03016X	10/32 X 1/2	100	
JMFS03020	10/32 X 5/8	100	
JMFS03024	10/32 X 3/4	100	
JMFS03028	10/32 X 7/8	100	
JMFS03032	10/32 X 1	100	
JMFS03040	10/32 X 1 1/4	100	
JMFS03048X	10/32 X 1 1/2	100	
JMFS03056	10/32 X 1 3/4	100	
JMFS03064	10/32 X 2	100	
JMFS03080	10/32 X 2 1/2	100	
JMFS03096	10/32 X 3	100	
JMF04016X	1/4-20 X 1/2	100	
JMF04020	1/4-20 X 5/8	100	
JMF04024	1/4-20 X 3/4	100	
JMF04032	1/4-20 X 1	100	
JMF04040	1/4-20 X 1 1/4	100	
JMF04048	1/4-20 X 1 1/2	100	
JMF04056	1/4-20 X 1 3/4	100	
JMF04064	1/4-20 X 2	100	
JMF04080X	1/4-20 X 2 1/2	50	
JMF04096	1/4-20 X 3	100	
JMF04160	1/4-20 X 5	50	
JMF04192	1/4-20 X 6	50	



**CALL - 1 (800) 723-2826**

**CALL: (800) 723-2826**

## PHILLIPS ROUND MACHINE SCREW

304 STAINLESS STEEL

Line: 1127-07

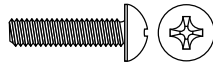

PART NUMBER	SIZE	QTY/BX	LIST PRICE
JRG88016	8/32 X 1/2	100	
JRG88032X	8/32 X 1	100	
JRG88048	8/32 X 1 1/2	100	
JRG03016X	10/24 X 1/2	100	
JRG03096	10/24 X 3	50	
JRGS03008X	10/32 X 1/4	100	
JRGS03048	10/32 X 1 1/2	100	
JRG04016	1/4-20 X 1/2	100	
JRG04024	1/4-20 X 3/4	100	
JRG04032	1/4-20 X 1	100	
JRG04056	1/4-20 X 1 3/4	50	
JRG04064	1/4-20 X 2	50	
JRG04096	1/4-20 X 3	50	
JRG05048	5/16-18 X 1 1/2	50	
JRG05064	5/16-18 X 2	50	

## SLOTTED OVAL HEAD MACHINE SCREW

BRASS

Line: 1127-08

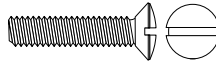

PART NUMBER	SIZE	QTY/BX	LIST PRICE
JDJ66012	6/32 X 3/8	100	
JDJ66016	6/32 X 1/2	100	
JDJ66024	6/32 X 3/4	100	
JDJ88016X	8/32 X 1/2	100	
JDJ03016	10/24 X 1/2	100	
JDJ04032X	1/4-20 X 1 CHROME PLATED	100	

## PHILLIPS FLAT HEAD MACHINE SCREW

BRASS

Line: 1127-09

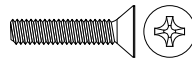

PART NUMBER	SIZE	QTY/BX	LIST PRICE
JIJ44008	4/40 X 1/4	100	
JIJ88008X	8/32 X 1/4	100	
JIJ88012	8/32 X 3/8	100	
JIJ03028	10/24 X 7/8	100	
JIJS03024	10/32 X 3/4	100	
JIJ04016	1/4-20 X 1/2	100	
JIJ04024	1/4-20 X 3/4	100	
JIJ04032	1/4-20 X 1	100	

## ROUND HEAD MACHINE SCREW - SLOTTED

NYLON

Line: 1127-15

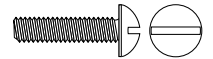

PART NUMBER	SIZE	QTY/BX	LIST PRICE
JSJ22008	2/56 X 1/4	100	
JSJ22010	2/56 X 5/16	100	
JSJ22012	2/56 X 3/8	100	
JSJ44014	4/40 X 7/16	100	
JSJ44016	4/40 X 1/2	100	
JSJ44020	4/40 X 5/8	100	
JSJ44024	4/40 X 3/4	100	
JSJ44032	4/40 X 1	100	
JSJ66008	6/32 X 1/4	100	
JSJ66010	6/32 X 5/16	100	
JSJ66012	6/32 X 3/8	100	
JSJ66016	6/32 X 1/2	100	
JSJ66020X	6/32 X 5/8	100	
JSJ66024X	6/32 X 3/4	100	
JSJ66028	6/32 X 7/8	100	
JSJ66032	6/32 X 1	100	
JSJ88012	8/32 X 3/8	100	
JSJ88014	8/32 X 7/16	100	
JSJ88016X	8/32 X 1/2	100	
JSJ88024	8/32 X 3/4	100	
JSJ03012	10/24 X 3/8	100	
JSJ03016	10/24 X 1/2	100	
JSJ03020	10/24 X 5/8	100	
JSJ03024X	10/24 X 3/4	100	
JSJ03032	10/24 X 1	100	
JSJS03016	10/32 X 1/2	100	
JSJS03020	10/32 X 5/8	100	
JSJS03024	10/32 X 3/4	100	
JSJS03032	10/32 X 1	100	
JSJS03040	10/32 X 1 1/4	100	
JSJS03048	10/32 X 1 1/2	100	
JSJ04064	1/4 X 2	100	
JSJ04012	1/4-20 X 3/8	100	
JSJ04016	1/4-20 X 1/2	100	
JSJ04024	1/4-20 X 3/4	100	
JSJ04032	1/4-20 X 1	100	

**HEX HEAD MACHINE SCREW**

NYLON

Line: 1127-16

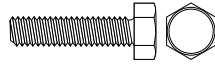

PART NUMBER	SIZE	QTY/BX	LIST PRICE
JYJ88024	8/32 X 3/4	100	
JYJ03024X	10/24 X 3/4	100	
JYJ03048	10/24 X 1 1/2	100	
JYJ04064	1/4-20 X 2 SLT	100	

**SLOTTED FLAT HEAD MACHINE SCREW**

NYLON

Line: 1127-17

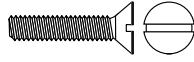

PART NUMBER	SIZE	QTY/BX	LIST PRICE
JAK44032	4/40 X 1	100	
JAK66016X	6/32 X 1/2	100	
JAK88020	8/32 X 5/8	100	
JAKS03024	10/32 X 3/4	100	
JAKS03032	10/32 X 1	100	
JAK04016	1/4-20 X 1/2	100	
JAK04020	1/4-20 X 5/8	100	
JAK04032	1/4-20 X 1	100	
JAK04040	1/4-20 X 1 1/4	100	

**SLOTTED PAN HEAD MACHINE SCREW**

NYLON

Line: 1127-18

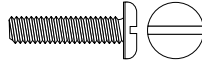

PART NUMBER	SIZE	QTY/BX	LIST PRICE
CCF22004	2/56 X 1/8	100	
CCF22012	2/56 X 3/8	100	
CCF44012	4/40 X 3/8	100	
CCF44014	4/40 X 7/16	100	
CCF66008	6/32 X 1/4	100	
CCF66010	6/32 X 5/16	100	
CCF66014	6/32 X 7/16	100	
CCF66016	6/32 X 1/2	100	
CCF88032	8/32 X 1	100	
CCF03012	10/24 X 3/8	100	
CCF03016	10/24 X 1/2	100	
CCF03024	10/24 X 3/4	100	
CCF03032	10/24 X 1	100	
CCF503016	10/32 X 1/2	100	
CCF04008	1/4-20 X 1/4	100	
CCF04010	1/4-20 X 5/16	100	
CCF04012	1/4-20 X 3/8	100	
CCF04014	1/4-20 X 7/16	100	
CCF04016	1/4-20 X 1/2	100	
CCF04032	1/4-20 X 1	100	

**SLOT PAN HEAD SHEET METAL SCREW**

304 STAINLESS STEEL

Line: 1128-00

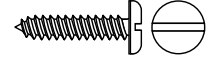

PART NUMBER	SIZE	QTY/BX	LIST PRICE
FZA44008	4 X 1/4	100	
FZA44012	4 X 3/8	100	
FZA44016	4 X 1/2	100	
FZA66008	6 X 1/4	100	
FZA66012	6 X 3/8	100	
FZA66016	6 X 1/2	100	
FZA66020	6 X 5/8	100	
FZA66024	6 X 3/4	100	
FZA66032	6 X 1	100	
FZA66040	6 X 1 1/4	100	
FZA66048	6 X 1 1/2	100	
FZA88008X	8 X 1/4	100	
FZA88012	8 X 3/8	100	
FZA88016	8 X 1/2	100	
FZA88020	8 X 5/8	100	
FZA88024	8 X 3/4	100	
FZA88032	8 X 1	100	
FZA88040	8 X 1 1/4	100	
FZA88048	8 X 1 1/2	100	
FZA03012	10 X 3/8	100	
FZA03016	10 X 1/2	100	
FZA03020	10 X 5/8	100	
FZA03024	10 X 3/4	100	
FZA03032	10 X 1	100	
FZA03040	10 X 1 1/4	100	
FZA03048	10 X 1 1/2	100	
FZA03056	10 X 1 3/4	100	
FZA03064	10 X 2	100	
FZA03080	10 X 2 1/2	50	
FZA21016	12 X 1/2	100	
FZA21020	12 X 5/8	100	
FZA21024	12 X 3/4	100	
FZA21032	12 X 1	100	
FZA21040	12 X 1 1/4	50	
FZA21048	12 X 1 1/2	50	
FZA21064X	12 X 2	50	
FZA21080	12 X 2 1/2	50	
FZA21096	12 X 3	50	
FZA04016X	14 X 1/2	100	
FZA04020	14 X 5/8	100	

(continued...)

**CALL: (800) 723-2826**

### SLOT PAN HEAD SHEET METAL SCREW (cont.)

304 STAINLESS STEEL

Line: 1128-00

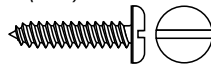

PART NUMBER	SIZE	QTY/BX	LIST PRICE
FZA04024	14 X 3/4	100	
FZA04032	14 X 1	100	
FZA04040	14 X 1 1/4	50	
FZA04048	14 X 1 1/2	50	
FZA04064X	14 X 2	50	
FZA04080	14 X 2 1/2	50	
FZA04096	14 X 3	50	

### SLOT HEX WASH. HD. SHEET METAL SCREW

18-8 STAINLESS STEEL

Line: 1128-01

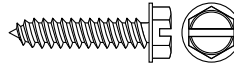

PART NUMBER	SIZE	QTY/BX	LIST PRICE
JWJ66012	6 X 3/8	100	
JWJ66016	6 X 1/2	100	
JWJ66020	6 X 5/8	100	
JWJ66024	6 X 3/4	100	
JWJ66032	6 X 1	100	
JWJ66048	6 X 1 1/2	100	
JWJ88016X	8 X 1/2	100	
JWJ88020	8 X 5/8	100	
JWJ88024X	8 X 3/4	100	
JWJ88032X	8 X 1	100	
JWJ88040	8 X 1 1/4	100	
JWJ88048	8 X 1 1/2	100	
JWJ88064	8 X 2	100	
JWJ03012	10 X 3/8	100	
JWJ03016X	10 X 1/2	100	
JWJ03020	#10 X 5/8	100	
JWJ03024X	10 X 3/4	100	
JWJ03032X	10 X 1	100	
JWJ03040	10 X 1 1/4	100	
JWJ03048	10 X 1 1/2	100	
JWJ03064	10 X 2	50	
JWJ03080	10 X 2 1/2	50	
JWJ03096	10 X 3	100	
JWJ21020	12 X 5/8	100	
JWJ21024	12 X 3/4	100	
JWJ21032X	12 X 1	100	
JWJ21040	12 X 1 1/4	100	
JWJ21048	12 X 1 1/2	100	
JWJ21064	12 X 2	100	

(continued...)

### SLOT HEX WASH. HD. SHEET METAL SCREW

18-8 STAINLESS STEEL (cont.)

Line: 1128-01

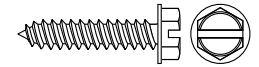

PART NUMBER	SIZE	QTY/BX	LIST PRICE
JWJ21080	12 X 2 1/2	50	
JWJ21096	12 X 3	50	
JWJ04016	14 X 1/2	100	
JWJ04020X	14 X 5/8	100	
JWJ04024X	14 X 3/4	100	
JWJ04032X	14 X 1	100	
JWJ04040	14 X 1 1/4	100	
JWJ04048	14 X 1 1/2	100	
JWJ04056	14 X 1 3/4	50	
JWJ04064	14 X 2	50	
JWJ04080	14 X 2 1/2	50	
JWJ04096	14 X 3	50	

### SLOTTED FLAT HEAD SHEET METAL SCREW

304 STAINLESS STEEL

Line: 1129-00



PART NUMBER	SIZE	QTY/BX	LIST PRICE
GAA44012	4 X 3/8	100	
GAA44016	4 X 1/2	100	
GAA44020	4 X 5/8	100	
GAA44024	4 X 3/4	100	
GAA66008	6 X 1/4	100	
GAA66012	6 X 3/8	100	
GAA66016	6 X 1/2	100	
GAA66020	6 X 5/8	100	
GAA66024	6 X 3/4	100	
GAA66032	6 X 1	100	
GAA66040	6 X 1 1/4	100	
GAA88016	8 X 1/2	100	
GAA88020	8 X 5/8	100	
GAA88024	8 X 3/4	100	
GAA88032	8 X 1	100	
GAA88040	8 X 1 1/4	100	
GAA88048	8 X 1 1/2	100	
GAA88064X	8 X 2	100	
GAA03016	10 X 1/2	100	
GAA03020	10 X 5/8	100	
GAA03024	10 X 3/4	100	
GAA03032	10 X 1	100	
GAA03040	10 X 1 1/4	100	
GAA03048	10 X 1 1/2	100	

(continued...)

**SLOTTED FLAT HEAD SHEET METAL SCREW (cont.)**

304 STAINLESS STEEL

Line: 1129-00

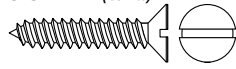

PART NUMBER	SIZE	QTY/BX	LIST PRICE
GAA03064	10 X 2	100	
GAA21016	12 X 1/2	100	
GAA21024	12 X 3/4	100	
GAA21032	12 X 1	100	
GAA21040	12 X 1 1/4	50	
GAA21048	12 X 1 1/2	50	
GAA04024	14 X 3/4	100	
GAA04032	14 X 1	100	
GAA04040	14 X 1 1/4	50	
GAA04048	14 X 1 1/2	50	
GAA04064	14 X 2	50	
GAA04080	14 X 2 1/2	50	

**SLOTTED ROUND HEAD SHEET METAL SCREW**

304 STAINLESS STEEL

Line: 1130-00

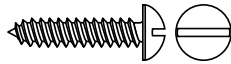

PART NUMBER	SIZE	QTY/BX	LIST PRICE
GBA66012X	6 X 3/8	100	
GBA66016	6 X 1/2	100	
GBA66020	6 X 5/8	100	
GBA66024	6 X 3/4	100	
GBA66032	6 X 1	100	
GBA88012	8 X 3/8	100	
GBA88016	8 X 1/2	100	
GBA88020	8 X 5/8	100	
GBA88024	8 X 3/4	100	
GBA88032	8 X 1	100	
GBA03016	10 X 1/2	100	
GBA03020	10 X 5/8	100	
GBA03024	10 X 3/4	100	
GBA03032	10 X 1	100	
GBA03040	10 X 1 1/4	100	
GBA03048	10 X 1 1/2	100	
GBA21048	12 X 1 1/2	50	
GBA04024	14 X 3/4	100	
GBA04048	14 X 1 1/2	50	

**SLOTTED TRUSS HEAD SHEET METAL SCREW**

304 STAINLESS STEEL

Line: 1131-00

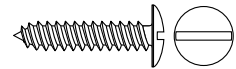

PART NUMBER	SIZE	QTY/BX	LIST PRICE
GCA44012	4 X 3/8	100	
GCA44016	4 X 1/2	100	
GCA44020	4 X 5/8	100	
GCA44024	4 X 3/4	100	
GCA66012	6 X 3/8	100	
GCA66016	6 X 1/2	100	
GCA66020	6 X 5/8	100	
GCA66024	6 X 3/4	100	
GCA66032	6 X 1	100	
GCA77016	7 X 1/2	100	
GCA88012	8 X 3/8	100	
GCA88016	8 X 1/2	100	
GCA88020	8 X 5/8	100	
GCA88024	8 X 3/4	100	
GCA88032	8 X 1	100	
GCA88040	8 X 1 1/4	100	
GCA88048	8 X 1 1/2	100	
GCA03012	10 X 3/8	100	
GCA03016	10 X 1/2	100	
GCA03020	10 X 5/8	100	
GCA03024	10 X 3/4	100	
GCA03032	10 X 1	100	
GCA03040	10 X 1 1/4	100	
GCA03048	10 X 1 1/2	100	
GCA04024	14 X 3/4	100	



**CALL - 1 (800) 723-2826**

## SLOTTED OVAL HEAD SHEET METAL SCREW

304 STAINLESS STEEL

Line: 1132-00

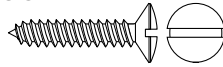

PART NUMBER	SIZE	QTY/BX	LIST PRICE
GDA44016	4 X 1/2	100	
GDA44024	4 X 3/4	100	
GDA66016	6 X 1/2	100	
GDA66020	6 X 5/8	100	
GDA66024	6 X 3/4	100	
GDA66032	6 X 1	100	
GDA88016	8 X 1/2	100	
GDA88020	8 X 5/8	100	
GDA88024	8 X 3/4	100	
GDA88032	8 X 1	100	
GDA88040	8 X 1 1/4	100	
GDA88048	8 X 1 1/2	100	
GDA03012X	10 X 3/8	100	
GDA03016	10 X 1/2	100	
GDA03020	10 X 5/8	100	
GDA03024	10 X 3/4	100	
GDA03032	10 X 1	100	
GDA03040	10 X 1 1/4	100	
GDA03048	10 X 1 1/2	100	
GDA21024	12 X 3/4	100	
GDA21032	12 X 1	100	
GDA21040	12 X 1 1/4	50	
GDA21048	12 X 1 1/2	50	
GDA04024	14 X 3/4	100	
GDA04032	14 X 1	100	
GDA04040	14 X 1 1/4	50	
GDA04048	14 X 1 1/2	50	

## PHILLIPS PAN HEAD SHEET METAL SCREW

304 STAINLESS STEEL

Line: 1133-00

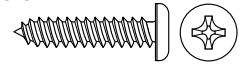

PART NUMBER	SIZE	QTY/BX	LIST PRICE
GEA44008X	4 X 1/4	100	
GEA44012	4 X 3/8	100	
GEA44016	4 X 1/2	100	
GEA44020	4 X 5/8	100	
GEA44024	4 X 3/4	100	
GEA44032	4 X 1	100	
GEA66008	6 X 1/4	100	
GEA66010	6 X 5/16	100	
GEA66012	6 X 3/8	100	
GEA66016	6 X 1/2	100	
GEA66020	6 X 5/8	100	
GEA66024	6 X 3/4	100	
GEA66024BLK	6 X 3/4 (BLACK ZINC)	100	
GEA66028	6 X 7/8	100	
GEA66032	6 X 1	100	
GEA66040	6 X 1 1/4	100	
GEA66048	6 X 1 1/2	100	
GEA66064	6 X 2	100	
GEA88008X	8 X 1/4	100	
GEA88012	8 X 3/8	100	
GEA88016	8 X 1/2	100	
GEA88020	8 X 5/8	100	
GEA88024	8 X 3/4	100	
GEA88024BLK	8 X 3/4 (BLACK ZINC)	500	
GEA88032	8 X 1	100	
GEA88040	8 X 1 1/4	100	
GEA88048	8 X 1 1/2	100	
GEA88056	8 X 1 3/4	100	
GEA88064X	8 X 2	100	
GEA88080	8 X 2 1/2	100	
GEA88096X	8 X 3	100	
GEA03012X	10 X 3/8	100	
GEA03016	10 X 1/2	100	
GEA03020	10 X 5/8	100	
GEA03024	10 X 3/4	100	
GEA03032	10 X 1	100	
GEA03040BLK	10 X 1 1/4 (BLACK ZINC)	100	
GEA03040X	10 X 1 1/4	100	
GEA03048	10 X 1 1/2	100	
GEA03056	10 X 1 3/4	100	

(continued...)



**PHILLIPS PAN HEAD SHEET METAL SCREW (cont.)**

304 STAINLESS STEEL

Line: 1133-00

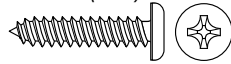

PART NUMBER	SIZE	QTY/BX	LIST PRICE
GEA03064	10 X 2	50	
GEA03080	10 X 2 1/2	50	
GEA03096	10 X 3	50	
GEA03112	10 X 3 1/2	50	
GEA03128	10 X 4	50	
GEA21016	12 X 1/2	100	
GEA21020	12 X 5/8	100	
GEA21024X	12 X 3/4	100	
GEA21032X	12 X 1	100	
GEA21040X	12 X 1 1/4	100	
GEA21048	12 X 1 1/2	100	
GEA21056	12 X 1 3/4	100	
GEA21064	12 X 2	50	
GEA21080	12 X 2 1/2	50	
GEA21096	12 X 3	50	
GEA04016	14 X 1/2	100	
GEA04020	14 X 5/8	100	
GEA04024	14 X 3/4	100	
GEA04032	14 X 1	100	
GEA04040X	14 X 1 1/4	100	
GEA04048X	14 X 1 1/2	100	
GEA04056	14 X 1 3/4	50	
GEA04064	14 X 2	50	
GEA04080	14 X 2 1/2	50	
GEA04096	14 X 3	50	

**PHILLIPS FLAT HEAD SHEET METAL SCREW**

304 STAINLESS STEEL

Line: 1134-00

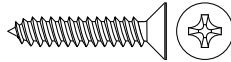

PART NUMBER	SIZE	QTY/BX	LIST PRICE
GFA44012	4 X 3/8	100	
GFA44016	4 X 1/2	100	
GFA44020	4 X 5/8	100	
GFA44024	4 X 3/4	100	
GFA44032	4 X 1	100	
GFA55016	5 X 1/2	100	
GFA55024	5 X 3/4	100	
GFA55032	5 X 1	100	
GFA66008X	6 X 1/4	100	
GFA66012	6 X 3/8	100	
GFA66016	6 X 1/2	100	

(continued...)

**PHILLIPS FLAT HEAD SHEET METAL SCREW (cont.)**

304 STAINLESS STEEL

Line: 1134-00

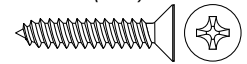

PART NUMBER	SIZE	QTY/BX	LIST PRICE
GFA66020	6 X 5/8	100	
GFA66024	6 X 3/4	100	
GFA66032	6 X 1	100	
GFA66040	6 X 1 1/4	100	
GFA66048	6 X 1 1/2	100	
GFA66064	6 X 2	100	
GFA88012	8 X 3/8	100	
GFA88016	8 X 1/2	100	
GFA88020	8 X 5/8	100	
GFA88024	8 X 3/4	100	
GFA88024W	8 X 3/4 (W/ WHITE HEADS)	500	
GFA88028	8 X 7/8	100	
GFA88032	8 X 1	100	
GFA88032BLK	8 X 1 (BLACK FINISH)	100	
GFA88032W	8 X 1 (W/ WHITE HEADS)	500	
GFA88040	8 X 1 1/4	100	
GFA88040BLK	8 X 1 1/4 (BLACK FINISH)	500	
GFA88048	8 X 1 1/2	100	
GFA88064	8 X 2	50	
GFA88080	8 X 2 1/2	50	
GFA03012	10 X 3/8	100	
GFA03016	10 X 1/2	100	
GFA03020	10 X 5/8	100	
GFA03024	10 X 3/4	100	
GFA03032	10 X 1	100	
GFA03040	10 X 1 1/4	100	
GFA03048	10 X 1 1/2	100	
GFA03048W	10 X 1 1/2 (W/ WHITE HEADS)	100	
GFA03056	10 X 1 3/4	50	
GFA03064	10 X 2	50	
GFA03080	10 X 2 1/2	50	
GFA03096	10 X 3	50	
GFA21016	12 X 1/2	100	
GFA21024	12 X 3/4	100	
GFA21032	12 X 1	100	
GFA21040	12 X 1 1/4	100	
GFA21048	12 X 1 1/2	100	
GFA21056	#12 X 1 3/4	100	
GFA21064	12 X 2	50	
GFA21080X	12 X 2 1/2	50	

(continued...)

**CALL: (800) 723-2826**

**PHILLIPS FLAT HEAD SHEET METAL SCREW (cont.)**

304 STAINLESS STEEL

Line: 1134-00

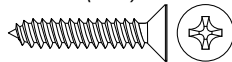

PART NUMBER	SIZE	QTY/BX	LIST PRICE
GFA21096	12 X 3	50	
GFA04016	14 X 1/2 (UNDERCUT)	100	
GFA04024	14 X 3/4	100	
GFA04032	14 X 1	100	
GFA04040	14 X 1 1/4	100	
GFA04048	14 X 1 1/2	100	
GFA04056	14 X 1 3/4	50	
GFA04064	14 X 2	50	
GFA04080	14 X 2 1/2	50	
GFA04096	14 X 3	50	
GFA04112	14 X 3 1/2	50	
GFA04128	14 X 4	50	

**PHILLIPS OVAL HEAD SHEET METAL SCREW**

304 STAINLESS STEEL

Line: 1135-00

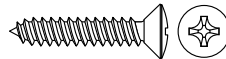

PART NUMBER	SIZE	QTY/BX	LIST PRICE
GGA44012	4 X 3/8	100	
GGA44016	4 X 1/2	100	
GGA44020	4 X 5/8	100	
GGA44024	4 X 3/4	100	
GGA44032	4 X 1	100	
GGA66012X	6 X 3/8	100	
GGA66016	6 X 1/2	100	
GGA66020	6 X 5/8	100	
GGA66024	6 X 3/4	100	
GGA66032	6 X 1	100	
GGA66032BLK	6 X 1 (BLACK FINISH)	100	
GGA66040X	6 X 1 1/4	100	
GGA66048X	6 X 1 1/2	100	
GGA66064	6 X 2	100	
GGA88012	8 X 3/8	100	
GGA88016	8 X 1/2	100	
GGA88020	8 X 5/8	100	
GGA88024	8 X 3/4	100	
GGA88024BLK	8 X 3/4 (BLACK FINISH)	100	
GGA88032	8 X 1	100	
GGA88032BLK	8 X 1 (BLACK FINISH)	100	
GGA88032BZ	8 X 1 (BLACK FINISH)	1000	
GGA88040BLK	8 X 1 1/4 (BLACK FINISH)	100	
GGA88040X	8 X 1 1/4	100	

(continued...)

**PHILLIPS OVAL HEAD SHEET METAL SCREW (cont.)**

304 STAINLESS STEEL

Line: 1135-00

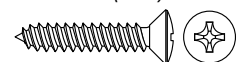

PART NUMBER	SIZE	QTY/BX	LIST PRICE
GGA88048	8 X 1 1/2	100	
GGA88056	8 X 1 3/4	100	
GGA88064	8 X 2	100	
GGA88080	8 X 2 1/2	50	
GGA88096	8 X 3	50	
GGA03016	10 X 1/2	100	
GGA03020	10 X 5/8	100	
GGA03024	10 X 3/4	100	
GGA03032	10 X 1	100	
GGA03040BLK	10 X 1 1/4 (BLACK FINISH)	100	
GGA03040X	10 X 1 1/4	100	
GGA03048BLK	10 X 1 1/2 (BLACK FINISH)	100	
GGA03048X	10 X 1 1/2	100	
GGA03056	10 X 1 3/4	50	
GGA03056C	10 X 1 3/4	100	
GGA03064	10 X 2	100	
GGA03080	10 X 2 1/2	50	
GGA03096	10 X 3	50	
GGA21016	12 X 1/2	100	
GGA21024	12 X 3/4	100	
GGA21032X	12 X 1	100	
GGA21040X	12 X 1 1/4	100	
GGA21048	12 X 1 1/2	100	
GGA21064	12 X 2	50	
GGA21080	12 X 2 1/2	50	
GGA21096	12 X 3	50	
GGA04024	14 X 3/4	100	
GGA04032	14 X 1	100	
GGA04040	14 X 1 1/4	100	
GGA04048	14 X 1 1/2	100	
GGA04056	14 X 1 3/4	50	
GGA04064	14 X 2	50	
GGA04080	14 X 2 1/2	50	
GGA04096	14 X 3	50	

**PHILLIPS TRUSS HEAD SHEET METAL SCREW**

304 STAINLESS STEEL

Line: 1136-00



PART NUMBER	SIZE	QTY/BX	LIST PRICE
GHA44008	4 X 1/4	100	
GHA44016	4 X 1/2	100	
GHA44020	4 X 5/8	100	
GHA44024	4 X 3/4	100	
GHA44032	4 X 1	100	
GHA66008	6 X 1/4	100	
GHA66012	6 X 3/8	100	
GHA66016	6 X 1/2	100	
GHA66020	6 X 5/8	100	
GHA66024	6 X 3/4	100	
GHA66032	6 X 1	100	
GHA66040	6 X 1 1/4	100	
GHA66048	6 X 1 1/2	100	
GHA88008	8 X 1/4	100	
GHA88012	8 X 3/8	100	
GHA88016	8 X 1/2	100	
GHA88020	8 X 5/8	100	
GHA88024	8 X 3/4	100	
GHA88032	8 X 1	100	
GHA88032BLK	8 X 1 (BLACK FINISH)	500	
GHA88040	8 X 1 1/4	100	
GHA88048	8 X 1 1/2	100	
GHA03012	10 X 3/8	100	
GHA03016	10 X 1/2	100	
GHA03020	10 X 5/8	100	
GHA03024	10 X 3/4	100	
GHA03032	10 X 1	100	
GHA03040	10 X 1 1/4	100	
GHA03048	10 X 1 1/2	100	
GHA21024	12 X 3/4	100	
GHA21032	12 X 1	100	
GHA21048	12 X 1 1/2	100	
GHA21064	12 X 2	50	
GHA04032	14 X 1	100	
GHA04040	14 X 1 1/4	100	
GHA04048	14 X 1 1/2	100	
GHA04064	14 X 2	100	

**PHILLIPS ROUND HEAD SHEET METAL SCREW**

304 STAINLESS STEEL

Line: 1137-00

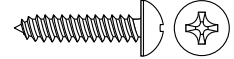

PART NUMBER	SIZE	QTY/BX	LIST PRICE
GJA66012	6 X 3/8	100	
GJA66016	6 X 1/2	100	
GJA66020	6 X 5/8	100	
GJA66024	6 X 3/4	100	
GJA66032	6 X 1	100	
GJA88012	8 X 3/8	100	
GJA88016	8 X 1/2	100	
GJA88020	8 X 5/8	100	
GJA88024	8 X 3/4	100	
GJA88032	8 X 1	100	
GJA03016	10 X 1/2	100	
GJA03020	10 X 5/8	100	
GJA03024	10 X 3/4	100	
GJA03032	10 X 1	100	

**SLOTTED PAN HEAD THREAD CUT MACHINE SCREW**

304 STAINLESS STEEL

Line: 1138-00

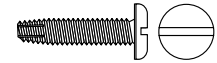

PART NUMBER	SIZE	QTY/BX	LIST PRICE
GKA66008	6/32 X 1/4	100	
GKA66012	6/32 X 3/8	100	
GKA66016	6/32 X 1/2	100	
GKA66020	6/32 X 5/8	100	
GKA88012	8/32 X 3/8	100	
GKA88016	8/32 X 1/2	100	
GKA88020	8/32 X 5/8	100	
GKA88024	8/32 X 3/4	100	
GKA88032	8/32 X 1	100	
GKA03012	10/24 X 3/8	100	
GKA03016	10/24 X 1/2	100	
GKA03020	10/24 X 5/8	100	
GKA03024	10/24 X 3/4	100	
GKAS03016	10/32 X 1/2	100	
GKAS03024X	10/32 X 3/4	100	
GKA04016	1/4-20 X 1/2	100	
GKA04024	1/4-20 X 3/4	100	

## SLOTTED FLAT HEAD THREAD CUT MACHINE SCREW

304 STAINLESS STEEL

Line: 1139-00

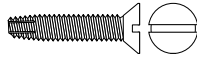

PART NUMBER	SIZE	QTY/BX	LIST PRICE
GLA66008	6/32 X 1/4	100	
GLA66012	6/32 X 3/8	100	
GLA66016	6/32 X 1/2	100	
GLA66020	6/32 X 5/8	100	
GLA88012	8/32 X 3/8	100	
GLA88016	8/32 X 1/2	100	
GLA88020	8/32 X 5/8	100	
GLA88024	8/32 X 3/4	100	
GLA03012	10/24 X 3/8	100	
GLA03016	10/24 X 1/2	100	
GLA03020	10/24 X 5/8	100	
GLA03024	10/24 X 3/4	100	

## PHILLIPS PAN HEAD THREAD CUT MACHINE SCREW

304 STAINLESS STEEL

Line: 1140-00

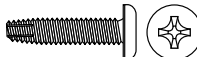

PART NUMBER	SIZE	QTY/BX	LIST PRICE
GRA66008	6/32 X 1/4	100	
GRA66012	6/32 X 3/8	100	
GRA66016	6/32 X 1/2	100	
GRA66020	6/32 X 5/8	100	
GRA66024X	6/32 X 3/4	100	
GRA66040	6/32 X 1 1/4	100	
GRA88012	8/32 X 3/8	100	
GRA88016	8/32 X 1/2	100	
GRA88020	8/32 X 5/8	100	
GRA88024	8/32 X 3/4	100	
GRA03012	10/24 X 3/8	100	
GRA03016	10/24 X 1/2	100	
GRA03020	10/24 X 5/8	100	
GRA03024	10/24 X 3/4	100	
GRAS03016X	10/32 X 1/2	100	
GRAS03020	10/32 X 5/8	100	
GRA04020	1/4-20 X 5/8	100	

## PHILLIPS FLAT HEAD THREAD CUT MACHINE SCREW

304 STAINLESS STEEL

Line: 1141-00

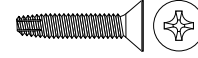

PART NUMBER	SIZE	QTY/BX	LIST PRICE
GSA66008	6/32 X 1/4	100	
GSA66012	6/32 X 3/8	100	
GSA66016	6/32 X 1/2	100	
GSA66020	6/32 X 5/8	100	
GSA88012	8/32 X 3/8	100	
GSA88016	8/32 X 1/2	100	
GSA88020	8/32 X 5/8	100	
GSA88024	8/32 X 3/4	100	
GSA03012	10/24 X 3/8	100	
GSA03016	10/24 X 1/2	100	
GSA03020	10/24 X 5/8	100	
GSA03024	10/24 X 3/4	100	
GSAS03024	10/32 X 3/4	100	

## SLOTTED FLAT HEAD WOOD SCREW

304 STAINLESS STEEL

Line: 1146-00

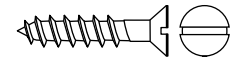

PART NUMBER	SIZE	QTY/BX	LIST PRICE
HNA44008X	4 X 1/4	100	
HNA44012	4 X 3/8	100	
HNA44016	4 X 1/2	100	
HNA44020	4 X 5/8	100	
HNA44024	4 X 3/4	100	
HNA44032	4 X 1	100	
HNA55016	5 X 1/2	100	
HNA55020	5 X 5/8	100	
HNA55024	5 X 3/4	100	
HNA55032X	5 X 1	100	
HNA66012	6 X 3/8	100	
HNA66016	6 X 1/2	100	
HNA66020	6 X 5/8	100	
HNA66024	6 X 3/4	100	
HNA66032	6 X 1	100	
HNA66040	6 X 1 1/4	100	
HNA66048	6 X 1 1/2	100	
HNA88016	8 X 1/2	100	
HNA88020	8 X 5/8	100	
HNA88024	8 X 3/4	100	
HNA88032	8 X 1	100	
HNA88040	8 X 1 1/4	100	

(continued...)

**SLOTTED FLAT HEAD WOOD SCREW (cont.)**

304 STAINLESS STEEL

Line: 1146-00

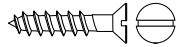

PART NUMBER	SIZE	QTY/BX	LIST PRICE
HNA88048	8 X 1 1/2	100	
HNA88056	8 X 1 3/4	100	
HNA88064	8 X 2	100	
HNA03024	10 X 3/4	100	
HNA03032	10 X 1	100	
HNA03040	10 X 1 1/4	100	
HNA03048	10 X 1 1/2	100	
HNA03056	10 X 1 3/4	100	
HNA03064	10 X 2	100	
HNA03080	10 X 2 1/2	100	
HNA21032	12 X 1	100	
HNA21040	12 X 1 1/4	100	
HNA21048	12 X 1 1/2	100	
HNA21056	12 X 1 3/4	100	
HNA21064	12 X 2	100	
HNA21080	12 X 2 1/2	100	
HNA21096	12 X 3	100	
HNA04032	14 X 1	100	
HNA04040	14 X 1 1/4	100	
HNA04048	14 X 1 1/2	100	
HNA04056	14 X 1 3/4	100	
HNA04064	14 X 2	100	
HNA04080	14 X 2 1/2	50	
HNA04096	14 X 3	50	

**SLOTTED ROUND HEAD WOOD SCREW**

304 STAINLESS STEEL

Line: 1146-01

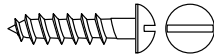

PART NUMBER	SIZE	QTY/BX	LIST PRICE
JCF22008X	2 X 1/4	100	
JCF22012X	2 X 3/8	100	
JCF22016X	2 X 1/2	100	
JCF44012X	4 X 3/8	100	
JCF44020X	4 X 5/8	100	
JCF66012X	6 X 3/8	100	
JCF66032X	6 X 1	100	
JCF66056X	6 X 1 3/4	100	
JCF66080X	6 X 2 1/2	100	
JCF88012X	8 X 3/8	100	
JCF88032X	8 X 1	100	
JCF88072X	8 X 2 1/4	100	

(continued...)

**SLOTTED ROUND HEAD WOOD SCREW**

304 STAINLESS STEEL

Line: 1146-01

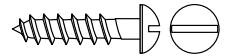

PART NUMBER	SIZE	QTY/BX	LIST PRICE
JCF03032X	10 X 1	100	
JCF03048X	10 X 1 1/2	100	
JCF03064X	10 X 2	100	
JCF04096	14 X 3	50	

**SLOTTED OVAL HEAD WOOD SCREW**

304 STAINLESS STEEL

Line: 1146-02

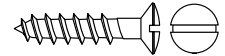

PART NUMBER	SIZE	QTY/BX	LIST PRICE
JDF44016X	4 X 1/2	100	
JDF44032X	4 X 1	100	
JDF55016X	5 X 1/2	100	
JDF55020X	5 X 5/8	100	
JDF55024X	5 X 3/4	100	
JDF88032X	8/32 X 1	100	
JDF88028X	8 X 7/8	100	
JDF03024X	10 X 3/4	100	
JDF03028X	10 X 7/8	100	
JDF03048X	10 X 1 1/2	100	
JDF21024X	12 X 3/4	100	
JDF21048X	12 X 1 1/2	100	

**SLOTTED FLAT HEAD WOOD SCREW**

BRASS

Line: 1147-00

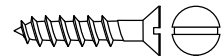

PART NUMBER	SIZE	QTY/BX	LIST PRICE
HJA11012	1 X 3/8	100	
HJA11016	1 X 1/2	100	
HJA22008	2 X 1/4	100	
HJA22012	2 X 3/8	100	
HJA22016	2 X 1/2	100	
HJA22020	2 X 5/8	100	
HJA22024	2 X 3/4	100	
HJA33008	3 X 1/4	100	
HJA33012	3 X 3/8	100	
HJA33016	3 X 1/2	100	
HJA33020	3 X 5/8	100	
HJA33024	3 X 3/4	100	
HJA44008	4 X 1/4	100	
HJA44012	4 X 3/8	100	
HJA44016	4 X 1/2	100	
HJA44020	4 X 5/8	100	

(continued...)

**CALL: (800) 723-2826**

**SLOTTED FLAT HEAD WOOD SCREW (cont.)**

BRASS

Line: 1147-00

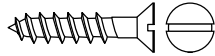

PART NUMBER	SIZE	QTY/BX	LIST PRICE
HJA44024	4 X 3/4	100	
HJA44028	4 X 7/8	100	
HJA44032	4 X 1	100	
HJA44040	4 X 1 1/4	100	
HJA44048	4 X 1 1/2	100	
HJA55012	5 X 3/8	100	
HJA55016	5 X 1/2	100	
HJA55020	5 X 5/8	100	
HJA55024	5 X 3/4	100	
HJA55028	5 X 7/8	100	
HJA55032	5 X 1	100	
HJA66012	6 X 3/8	100	
HJA66016	6 X 1/2	100	
HJA66020	6 X 5/8	100	
HJA66024	6 X 3/4	100	
HJA66028	6 X 7/8	100	
HJA66032	6 X 1	100	
HJA66040	6 X 1 1/4	100	
HJA66048	6 X 1 1/2	100	
HJA66056	6 X 1 3/4	100	
HJA66064	6 X 2	100	
HJA77012	7 X 3/8	100	
HJA77016	7 X 1/2	100	
HJA77020	7 X 5/8	100	
HJA77024	7 X 3/4	100	
HJA77028	7 X 7/8	100	
HJA77032	7 X 1	100	
HJA77040	7 X 1 1/4	100	
HJA77048	7 X 1 1/2	100	
HJA77064	7 X 2	100	
HJA88012	8 X 3/8	100	
HJA88016	8 X 1/2	100	
HJA88020	8 X 5/8	100	
HJA88024	8 X 3/4	100	
HJA88028	8 X 7/8	100	
HJA88032	8 X 1	100	
HJA88040	8 X 1 1/4	100	
HJA88048	8 X 1 1/2	100	
HJA88056	8 X 1 3/4	100	
HJA88064	8 X 2	100	

(continued...)

**SLOTTED FLAT HEAD WOOD SCREW (cont.)**

BRASS

Line: 1147-00

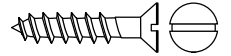

PART NUMBER	SIZE	QTY/BX	LIST PRICE
HJA88080	8 X 2 1/2	100	
HJA99028	9 X 7/8	100	
HJA99064	9 X 2	100	
HJA03016	10 X 1/2	100	
HJA03020	10 X 5/8	100	
HJA03024	10 X 3/4	100	
HJA03028	10 X 7/8	100	
HJA03032	10 X 1	100	
HJA03040	10 X 1 1/4	100	
HJA03048	10 X 1 1/2	100	
HJA03056	10 X 1 3/4	100	
HJA03064	10 X 2	100	
HJA03080	10 X 2 1/2	100	
HJA03096	10 X 3	100	
HJA21024	12 X 3/4	100	
HJA21028	12 X 7/8	100	
HJA21032	12 X 1	100	
HJA21040	12 X 1 1/4	100	
HJA21048	12 X 1 1/2	100	
HJA21056	12 X 1 3/4	100	
HJA21064	12 X 2	100	
HJA21080	12 X 2 1/2	100	
HJA21088	12 X 2 3/4	100	
HJA21096	12 X 3	100	
HJA21128	12 X 4	100	
HJA04024	14 X 3/4	100	
HJA04028	14 X 7/8	100	
HJA04032	14 X 1	100	
HJA04040	14 X 1 1/4	100	
HJA04048	14 X 1 1/2	100	
HJA04056	14 X 1 3/4	100	
HJA04064	14 X 2	100	
HJA04080	14 X 2 1/2	100	
HJA04088	14 X 2 3/4	100	
HJA04096	14 X 3	100	
HJA04112	14 X 3 1/2	100	
HJA04128	14 X 4	100	

## SLOTTED ROUND HEAD WOOD SCREW

BRASS

Line: 1148-00

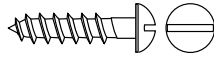

PART NUMBER	SIZE	QTY/BX	LIST PRICE
HKA11008	1 X 1/4	100	
HKA11012	1 X 3/8	100	
HKA11016	1 X 1/2	100	
HKA22008	2 X 1/4	100	
HKA22012	2 X 3/8	100	
HKA22016	2 X 1/2	100	
HKA22020	2 X 5/8	100	
HKA22024	2 X 3/4	100	
HKA33012	3 X 3/8	100	
HKA33016	3 X 1/2	100	
HKA33020	3 X 5/8	100	
HKA33024	3 X 3/4	100	
HKA33028	3 X 7/8	100	
HKA33032	3 X 1	100	
HKA44008	4 X 1/4	100	
HKA44012	4 X 3/8	100	
HKA44016	4 X 1/2	100	
HKA44020	4 X 5/8	100	
HKA44024	4 X 3/4	100	
HKA44028	4 X 7/8	100	
HKA44032	4 X 1	100	
HKA44040	4 X 1 1/4	100	
HKA44048	4 X 1 1/2	100	
HKA55012	5 X 3/8	100	
HKA55016	5 X 1/2	100	
HKA55020	5 X 5/8	100	
HKA55024	5 X 3/4	100	
HKA55032	5 X 1	100	
HKA66012	6 X 3/8	100	
HKA66016	6 X 1/2	100	
HKA66020	6 X 5/8	100	
HKA66024	6 X 3/4	100	
HKA66028	6 X 7/8	100	
HKA66032	6 X 1	100	
HKA66040	6 X 1 1/4	100	
HKA66048	6 X 1 1/2	100	
HKA66056	6 X 1 3/4	100	
HKA66064	6 X 2	100	
HKA77016	7 X 1/2	100	

(continued...)

## SLOTTED ROUND HEAD WOOD SCREW (cont.)

BRASS

Line: 1148-00

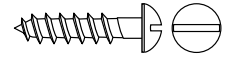

PART NUMBER	SIZE	QTY/BX	LIST PRICE
HKA77020	7 X 5/8	100	
HKA77024	7 X 3/4	100	
HKA88012X	8 X 3/8	100	
HKA88016	8 X 1/2	100	
HKA88020	8 X 5/8	100	
HKA88024	8 X 3/4	100	
HKA88028	8 X 7/8	100	
HKA88032	8 X 1	100	
HKA88040	8 X 1 1/4	100	
HKA88048	8 X 1 1/2	100	
HKA88056	8 X 1 3/4	100	
HKA88064	8 X 2	100	
HKA88080	8 X 2 1/2	100	
HKA88096	8 X 3	100	
HKA03024	10 X 3/4	100	
HKA03032	10 X 1	100	
HKA03040	10 X 1 1/4	100	
HKA03048	10 X 1 1/2	100	
HKA03056	10 X 1 3/4	100	
HKA03064	10 X 2	100	
HKA03072	10 X 2 1/4	100	
HKA03080	10 X 2 1/2	100	
HKA03096	10 X 3	100	
HKA21020	12 X 5/8	100	
HKA21024	12 X 3/4	100	
HKA21032	12 X 1	100	
HKA21040	12 X 1 1/4	100	
HKA21048	12 X 1 1/2	100	
HKA21064	12 X 2	100	
HKA21080	12 X 2 1/2	100	
HKA21096	12 X 3	50	
HKA04016	14 X 1/2	100	
HKA04020	14 X 5/8	100	
HKA04024	14 X 3/4	100	
HKA04028	14 X 7/8	100	
HKA04032	14 X 1	100	
HKA04040	14 X 1 1/4	100	
HKA04048	14 X 1 1/2	100	
HKA04056	14 X 1 3/4	100	

(continued...)

**SLOTTED ROUND HEAD WOOD SCREW (cont.)**

BRASS

Line: 1148-00

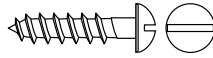

PART NUMBER	SIZE	QTY/BX	LIST PRICE
HKA04064	14 X 2	100	
HKA04080	14 X 2 1/2	50	
HKA04096	14 X 3	50	

**SLOTTED OVAL HEAD WOOD SCREW**

BRASS

Line: 1149-00

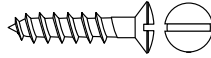

PART NUMBER	SIZE	QTY/BX	LIST PRICE
HLA44008	4 X 1/4	100	
HLA44012	4 X 3/8	100	
HLA44016	4 X 1/2	100	
HLA44020	4 X 5/8	100	
HLA44024	4 X 3/4	100	
HLA66016	6 X 1/2	100	
HLA66020	6 X 5/8	100	
HLA66024	6 X 3/4	100	
HLA66032	6 X 1	100	
HLA66040	6 X 1 1/4	100	
HLA88024	8 X 3/4	100	
HLA88032	8 X 1	100	
HLA88040	8 X 1 1/4	100	
HLA88048	8 X 1 1/2	100	
HLA88064	8 X 2	100	
HLA03024	10 X 3/4	100	
HLA03028	10 X 7/8	100	
HLA03032	10 X 1	100	
HLA03040	10 X 1 1/4	100	
HLA03048	10 X 1 1/2	100	
HLA03064	10 X 2	100	

**SLOTTED FLAT HEAD WOOD SCREW**

SILICON BRONZE

Line: 1151-00

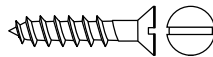

PART NUMBER	SIZE	QTY/BX	LIST PRICE
HRA88024	8 X 3/4	100	
HRA03040	10 X 1 1/4	100	

**PHILLIPS OVAL HEAD WOOD SCREW**

BRASS

Line: 1153-01



PART NUMBER	SIZE	QTY/BX	LIST PRICE
JVH66016	6 X 1/2	100	
JVH66024	6 X 3/4	100	
JVH66032	6 X 1	100	
JVH66040	6 X 1 1/4	100	
JVH66048	6 X 1 1/2	100	
JVH66048NPX	6 X 1 1/2 (NICKEL PLATED)	100	
JVH88016	8 X 1/2	100	
JVH88024	8 X 3/4	100	
JVH88032	8 X 1	100	
JVH88040	8 X 1 1/4	100	
JVH88048	8 X 1 1/2	100	
JVH03024	10 X 3/4	100	
JVH03032	10 X 1	100	
JVH03040	10 X 1 1/4	100	
JVH03048	10 X 1 1/2	100	
JVH03064	10 X 2	100	

**PHILLIPS FLAT HEAD WOOD SCREW**

BRASS

Line: 1153-02



PART NUMBER	SIZE	QTY/BX	LIST PRICE
ASL22008	2 X 1/4	100	
ASL22012	2 X 3/8	100	
ASL22016	2 X 1/2	100	
ASL22020	2 X 5/8	100	
ASL22024	2 X 3/4	100	
ASL33012	3 X 3/8	100	
ASL33016	3 X 1/2	100	
ASL33020	3 X 5/8	100	
ASL33024	3 X 3/4	100	
ASL44012	4 X 3/8	100	
ASL44016	4 X 1/2	100	
ASL44020	4 X 5/8	100	
ASL44024	4 X 3/4	100	
ASL44032	4 X 1	100	
ASL55016	5 X 1/2	100	
ASL55020	5 X 5/8	100	
ASL55024	5 X 3/4	100	
ASL55028	5 X 7/8	100	
ASL55032	5 X 1	100	
ASL66016	6 X 1/2	100	

(continued...)



**PHILLIPS FLAT HEAD WOOD SCREW (cont.)**

BRASS

Line: 1153-02

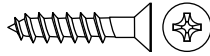

PART NUMBER	SIZE	QTY/BX	LIST PRICE
ASL66020	6 X 5/8	100	
ASL66024	6 X 3/4	100	
ASL66032	6 X 1	100	
ASL66040	6 X 1 1/4	100	
ASL66048	6 X 1 1/2	100	
ASL66056	6 X 1 3/4	100	
ASL66064	6 X 2	100	
ASL77016	7 X 1/2	100	
ASL77020	7 X 5/8	100	
ASL77024	7 X 3/4	100	
ASL77032	7 X 1	100	
ASL77040	7 X 1 1/4	100	
ASL77048	7 X 1 1/2	100	
ASL88016	8 X 1/2	100	
ASL88020	8 X 5/8	100	
ASL88024	8 X 3/4	100	
ASL88028	8 X 7/8	100	
ASL88032	8 X 1	100	
ASL88040	8 X 1 1/4	100	
ASL88048	8 X 1 1/2	100	
ASL88056	8 X 1 3/4	100	
ASL88064	8 X 2	100	
ASL88080	8 X 2 1/2	100	
ASL88096	8 X 3	100	
ASL99040	9 X 1 1/4	100	
ASL03024	10 X 3/4	100	
ASL03032	10 X 1	100	
ASL03040	10 X 1 1/4	100	
ASL03048	10 X 1 1/2	100	
ASL03056	10 X 1 3/4	100	
ASL03064	10 X 2	100	
ASL03080	10 X 2 1/2	100	
ASL03096	10 X 3	100	
ASL03128	10 X 4	100	
ASL21024	12 X 3/4	100	
ASL21032	12 X 1	100	
ASL21040	12 X 1 1/4	100	
ASL21048	12 X 1 1/2	100	
ASL21056	12 X 1 3/4	100	
ASL21064	12 X 2	100	

(continued...)

**PHILLIPS FLAT HEAD WOOD SCREW (cont.)**

BRASS

Line: 1153-02

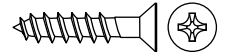

PART NUMBER	SIZE	QTY/BX	LIST PRICE
ASL21080	12 X 2 1/2	100	
ASL21096	12 X 3	100	
ASL04032	14 X 1	100	
ASL04040	14 X 1 1/4	100	
ASL04048	14 X 1 1/2	100	
ASL04056	14 X 1 3/4	100	
ASL04064	14 X 2	50	
ASL04080	14 X 2 1/2	50	
ASL04096	14 X 3	50	

**PHILLIPS FLAT HEAD WOOD SCREW**

STAINLESS STEEL

Line: 1153-03



PART NUMBER	SIZE	QTY/BX	LIST PRICE
BEF66016	6 X 1/2	100	
BEF66024	6 X 3/4	100	
BEF66032	6 X 1	100	
BEF66040	6 X 1 1/4	100	
BEF66048	6 X 1 1/2	100	
BEF88016	8 X 1/2	100	
BEF88024	8 X 3/4	100	
BEF88032	8 X 1	100	
BEF88040	8 X 1 1/4	100	
BEF88048	8 X 1 1/2	100	
BEF88064	8 X 2	100	
BEF03024	10 X 3/4	100	
BEF03032	10 X 1	100	
BEF03040	10 X 1 1/4	100	
BEF03048	10 X 1 1/2	100	
BEF03056	10 X 1 3/4	100	
BEF03064	10 X 2	100	
BEF03080	10 X 2 1/2	100	
BEF03096	10 X 3	100	
BEF21032	12 X 1	100	
BEF21040	12 X 1 1/4	100	
BEF21048	12 X 1 1/2	100	
BEF21064	12 X 2	100	
BEF21080	12 X 2 1/2	50	
BEF21096	12 X 3	50	
BEF04048	14 X 1 1/2	100	
BEF04064	14 X 2	100	

(continued...)

**CALL: (800) 723-2826**

**PHILLIPS FLAT HEAD WOOD SCREW (cont.)**

STAINLESS STEEL

Line: 1153-03

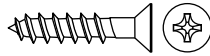

PART NUMBER	SIZE	QTY/BX	LIST PRICE
BEF04080	14 X 2 1/2	50	
BEF04096	14 X 3	50	
BEF04128	14 X 4	50	

**PHILLIPS FLAT HEAD WOOD SCREW**

SILICON BRONZE

Line: 1153-04

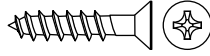

PART NUMBER	SIZE	QTY/BX	LIST PRICE
CZB66024	6 X 3/4	100	
CZB66032	6 X 1	100	
CZB88020	8 X 5/8	100	
CZB88024	8 X 3/4	100	
CZB88032	8 X 1	100	
CZB88040	8 X 1 1/4	100	
CZB03024	10 X 3/4	100	
CZB03032	10 X 1	100	
CZB03040	10 X 1 1/4	100	
CZB03048	10 X 1 1/2	100	

**THUMB SCREW TYPE P (NO SHOULDER)**

304 STAINLESS STEEL

Line: 1154-00

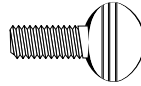

PART NUMBER	SIZE	QTY/BX	LIST PRICE
KHA66016	6/32 X 1/2	100	
KHA66024	6/32 X 3/4	100	
KHA88012	8/32 X 3/8	100	
KHA88016	8/32 X 1/2	100	
KHA88020	8/32 X 5/8	100	
KHA88024	8/32 X 3/4	100	
KHA88032	8/32 X 1	100	
KHA03016	10/24 X 1/2	100	
KHA03020	10/24 X 5/8	100	
KHA03024	10/24 X 3/4	100	
KHA03032	10/24 X 1	100	
KHAS03012	10/32 X 3/8	100	
KHAS03016	10/32 X 1/2	100	
KHAS03020	10/32 X 5/8	100	
KHAS03024	10/32 X 3/4	100	
KHAS03032	10/32 X 1	100	
KHA04016X	1/4-20 X 1/2	100	
KHA04024	1/4-20 X 3/4	100	
KHA04032	1/4-20 X 1	100	

(continued...)

**THUMB SCREW TYPE P (NO SHOULDER)**

304 STAINLESS STEEL (cont.)

Line: 1154-00

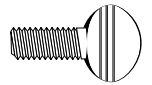

PART NUMBER	SIZE	QTY/BX	LIST PRICE
KHA04048	1/4-20 X 1 1/2	100	
KHA04064	1/4-20 X 2	100	
KHA05016	5/16-18 X 1/2	100	
KHA05024	5/16-18 X 3/4	100	
KHA05032	5/16-18 X 1	100	
KHA05040	5/16-18 X 1 1/4	100	
KHA05048	5/16-18 X 1 1/2	100	
KHA05064	5/16-18 X 2	100	
KHA06024	3/8-16 X 3/4	100	
KHA06032	3/8-16 X 1	100	
KHA06040	3/8-16 X 1 1/4	100	
KHA06048	3/8-16 X 1 1/2	100	
KHA06064	3/8-16 X 2	50	

**THUMB SCREW TYPE S (SHOULDER)**

304 STAINLESS STEEL

Line: 1155-00

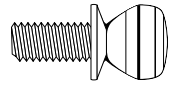

PART NUMBER	SIZE	QTY/BX	LIST PRICE
ABL88012	8/32 X 3/8	100	
ABL88016	8/32 X 1/2	100	
ABL88024	8/32 X 3/4	100	
ABL88032	8/32 X 1	100	
ABL03016	10/24 X 1/2	100	
ABL03024	10/24 X 3/4	100	
ABL03032	10/24 X 1	100	
ABLS03012	10/32 X 3/8	100	
ABLS03016	10/32 X 1/2	100	
ABL04016	1/4-20 X 1/2	100	
ABL04040	1/4-20 X 1 1/4	100	
ABL05040	5/16-18 X 1 1/4	100	
ABL06040	3/8-16 X 1 1/4	100	

**SOCKET HEAD CAP SCREW**

304 STAINLESS STEEL

Line: 1156-00

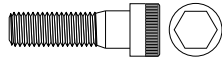

PART NUMBER	SIZE	QTY/BX	LIST PRICE
JAA22006	2/56 X 3/16	100	
JAA22008	2/56 X 1/4	100	
JAA44006	4/40 X 3/16	100	
JAA44008	4/40 X 1/4	100	
JAA44012	4/40 X 3/8	100	
JAA44016	4/40 X 1/2	100	
JAA44020	4/40 X 5/8	100	
JAA44024	4/40 X 3/4	100	
JAA44032	4/40 X 1	100	
JAA66008	6/32 X 1/4	100	
JAA66012	6/32 X 3/8	100	
JAA66016	6/32 X 1/2	100	
JAA66020	6/32 X 5/8	100	
JAA66024	6/32 X 3/4	100	
JAA66028	6/32 X 7/8	100	
JAA66032	6/32 X 1	100	
JAA66040X	6/32 X 1 1/4	100	
JAA66048	6/32 X 1 1/2	100	
JAA66064	6/32 X 2	100	
JAA88008	8/32 X 1/4	100	
JAA88012	8/32 X 3/8	100	
JAA88016	8/32 X 1/2	100	
JAA88020	8/32 X 5/8	100	
JAA88024	8/32 X 3/4	100	
JAA88028	8/32 X 7/8	100	
JAA88032	8/32 X 1	100	
JAA88040	8/32 X 1 1/4	100	
JAA88048	8/32 X 1 1/2	100	
JAA88064	8/32 X 2	100	
JAA03010	10/24 X 5/16	100	
JAA03012	10/24 X 3/8	100	
JAA03016	10/24 X 1/2	100	
JAA03020	10/24 X 5/8	100	
JAA03024	10/24 X 3/4	100	
JAA03028	10/24 X 7/8	100	
JAA03032	10/24 X 1	100	
JAA03040	10/24 X 1 1/4	100	
JAA03048	10/24 X 1 1/2	100	
JAA03064	10/24 X 2	100	
JAAS03008X	10/32 X 1/4	100	

(continued...)

**SOCKET HEAD CAP SCREW (cont.)**

304 STAINLESS STEEL

Line: 1156-00

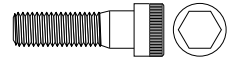

PART NUMBER	SIZE	QTY/BX	LIST PRICE
JAAS03012	10/32 X 3/8	100	
JAAS03016	10/32 X 1/2	100	
JAAS03020	10/32 X 5/8	100	
JAAS03024	10/32 X 3/4	100	
JAAS03028	10/32 X 7/8	100	
JAAS03032	10/32 X 1	100	
JAAS03040	10/32 X 1 1/4	100	
JAAS03048	10/32 X 1 1/2	100	
JAAS03056	10/32 X 1 3/4	100	
JAAS03080	10/32 X 2 1/2	100	
JAA04012	1/4-20 X 3/8	100	
JAA04016	1/4-20 X 1/2	100	
JAA04020	1/4-20 X 5/8	100	
JAA04024	1/4-20 X 3/4	100	
JAA04028	1/4-20 X 7/8	100	
JAA04032	1/4-20 X 1	100	
JAA04040	1/4-20 X 1 1/4	100	
JAA04048	1/4-20 X 1 1/2	100	
JAA04056	1/4-20 X 1 3/4	100	
JAA04064	1/4-20 X 2	100	
JAA04072	1/4-20 X 2 1/4	50	
JAA04080	1/4-20 X 2 1/2	50	
JAA04096X	1/4-20 X 3	50	
JAAS04016	1/4-28 X 1/2	100	
JAAS04020	1/4-28 X 5/8	100	
JAAS04024	1/4-28 X 3/4	100	
JAAS04028	1/4-28 X 7/8	100	
JAAS04032	1/4-28 X 1	100	
JAAS04048	1/4-28 X 1 1/2	100	
JAAS04064	1/4-28 X 2	100	
JAA05012X	5/16-18 X 3/8	100	
JAA05016	5/16-18 X 1/2	100	
JAA05020	5/16-18 X 5/8	100	
JAA05024	5/16-18 X 3/4	100	
JAA05028	5/16-18 X 7/8	100	
JAA05032	5/16-18 X 1	100	
JAA05040	5/16-18 X 1 1/4	100	
JAA05048	5/16-18 X 1 1/2	100	
JAA05056	5/16-18 X 1 3/4	100	
JAA05064	5/16-18 X 2	100	

(continued...)

**CALL: (800) 723-2826**

## SOCKET HEAD CAP SCREW (cont.)

304 STAINLESS STEEL

Line: 1156-00

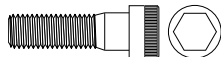

PART NUMBER	SIZE	QTY/BX	LIST PRICE
JAA05072	5/16-18 X 2 1/4	50	
JAA05080X	5/16-18 X 2 1/2	50	
JAA05024	5/16-24 X 3/4	100	
JAA05032	5/16-24 X 1	100	
JAA05040X	5/16-24 X 1 1/4	100	
JAA05048X	5/16-24 X 1 1/2	100	
JAA05064	5/16-24 X 2	100	
JAA05080	5/16-24 X 2 1/2	50	
JAA06016	3/8-16 X 1/2	100	
JAA06020	3/8-16 X 5/8	100	
JAA06024	3/8-16 X 3/4	100	
JAA06028	3/8-16 X 7/8	100	
JAA06032	3/8-16 X 1	100	
JAA06040	3/8-16 X 1 1/4	100	
JAA06048	3/8-16 X 1 1/2	100	
JAA06056	3/8-16 X 1 3/4	50	
JAA06064	3/8-16 X 2	50	
JAA06072	3/8-16 X 2 1/4	50	
JAA06080	3/8-16 X 2 1/2	50	
JAA06088	3/8-16 X 2 3/4	50	
JAA06096X	3/8-16 X 3	50	
JAA06104	3/8-16 X 3 1/4	25	
JAA06112	3/8-16 X 3 1/2	25	
JAA06016	3/8-24 X 1/2	100	
JAA06024	3/8-24 X 3/4	100	
JAA06040	3/8-24 X 1 1/4	100	
JAA07024	7/16-14 X 3/4	50	
JAA08032	1/2-13 X 1	50	
JAA08040	1/2-13 X 1 1/4	50	
JAA08048	1/2-13 X 1 1/2	50	
JAA08056	1/2-13 X 1 3/4	50	
JAA08064	1/2-13 X 2	50	
JAA08072	1/2-13 X 2 1/4	25	
JAA08080	1/2-13 X 2 1/2	25	
JAA08088	1/2-13 X 2 3/4	25	
JAA08096	1/2-13 X 3	25	
JAA08032	1/2-20 X 1	50	
JAA08040X	1/2-20 X 1 1/4	50	
JAA10040	5/8-11 X 1 1/4	25	
JAA10048	5/8-11 X 1 1/2	25	

(continued...)

## SOCKET HEAD CAP SCREW (cont.)

304 STAINLESS STEEL

Line: 1156-00

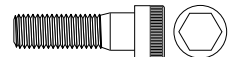

PART NUMBER	SIZE	QTY/BX	LIST PRICE
JAA10056	5/8-11 X 1 3/4	25	
JAA10064	5/8-11 X 2	25	
JAA10080	5/8-11 X 2 1/2	25	
JAA10088	5/8-11 X 2 3/4	25	
JAA10096	5/8-11 X 3	25	
JAA10112X	5/8-11 X 3 1/2	25	
JAA10128X	5/8-11 X 4	25	
JAA12056	3/4 X 1 3/4	25	
JAA12048	3/4-10 X 1 1/2	10	
JAA12080	3/4-10 X 2 1/2	25	
JAA12088	3/4-10 X 2 3/4	25	

## SOCKET HEAD CAP SCREW

NYLON

Line: 1156-02

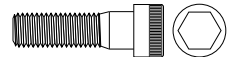

PART NUMBER	SIZE	QTY/BX	LIST PRICE
CGMS03016	10/32 X 1/2	100	
CGMS03024	10/32 X 3/4	100	
CGMS03032	10/32 X 1	100	
CGMS03040	10/32 X 1 1/4	100	

## FLAT SOCKET CAP SCREW

304 STAINLESS STEEL

Line: 1157-00

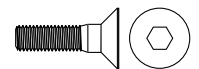

PART NUMBER	SIZE	QTY/BX	LIST PRICE
JEA22008	2/56 X 1/4	100	
JEA44008	4/40 X 1/4	100	
JEA44012	4/40 X 3/8	100	
JEA44016	4/40 X 1/2	100	
JEA66008X	6/32 X 1/4	100	
JEA66012	6/32 X 3/8	100	
JEA66016	6/32 X 1/2	100	
JEA66020	6/32 X 5/8	100	
JEA66024	6/32 X 3/4	100	
JEA88012	8/32 X 3/8	100	
JEA88016	8/32 X 1/2	100	
JEA88020	8/32 X 5/8	100	
JEA88024	8/32 X 3/4	100	
JEA88032	8/32 X 1	100	
JEA03012	10/24 X 3/8	100	
JEA03016	10/24 X 1/2	100	
JEA03020	10/24 X 5/8	100	

(continued...)

**FLAT SOCKET CAP SCREW (cont.)**

304 STAINLESS STEEL

Line: 1157-00

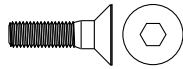

PART NUMBER	SIZE	QTY/BX	LIST PRICE
JEA03024	10/24 X 3/4	100	
JEA03032	10/24 X 1	100	
JEA03040	10/24 X 1 1/4	100	
JEA03048	10/24 X 1 1/2	100	
JEA03064	10/24 X 2	100	
JEA03008X	10/32 X 1/4	100	
JEA03012	10/32 X 3/8	100	
JEA03016	10/32 X 1/2	100	
JEA03020	10/32 X 5/8	100	
JEA03024	10/32 X 3/4	100	
JEA03032	10/32 X 1	100	
JEA04016	1/4-20 X 1/2	100	
JEA04020	1/4-20 X 5/8	100	
JEA04024	1/4-20 X 3/4	100	
JEA04032	1/4-20 X 1	100	
JEA04040	1/4-20 X 1 1/4	100	
JEA04048	1/4-20 X 1 1/2	100	
JEA04056	1/4-20 X 1 3/4	100	
JEA04064	1/4-20 X 2	100	
JEA04072	1/4-20 X 2 1/4	100	
JEA04080	1/4-20 X 2 1/2	50	
JEA05016	5/16-18 X 1/2	100	
JEA05020	5/16-18 X 5/8	100	
JEA05024	5/16-18 X 3/4	100	
JEA05028	5/16-18 X 7/8	100	
JEA05032	5/16-18 X 1	100	
JEA05040	5/16-18 X 1 1/4	100	
JEA05048	5/16-18 X 1 1/2	100	
JEA05056	5/16-18 X 1 3/4	100	
JEA05064	5/16-18 X 2	100	
JEA05072	5/16-18 X 2 1/4	50	
JEA05080	5/16-18 X 2 1/2	50	
JEA05096	5/16-18 X 3	50	
JEA06016	3/8-16 X 1/2	100	
JEA06020	3/8-16 X 5/8	100	
JEA06024	3/8-16 X 3/4	100	
JEA06032	3/8-16 X 1	100	
JEA06040	3/8-16 X 1 1/4	100	
JEA06048	3/8-16 X 1 1/2	100	
JEA06056	3/8-16 X 1 3/4	50	

(continued...)

**FLAT SOCKET CAP SCREW (cont.)**

304 STAINLESS STEEL

Line: 1157-00

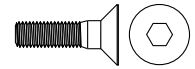

PART NUMBER	SIZE	QTY/BX	LIST PRICE
JEA06064	3/8-16 X 2	50	
JEA06072	3/8-16 X 2 1/4	50	
JEA06080	3/8-16 X 2 1/2	50	
JEA06096	3/8-16 X 3	50	
JEA08024	1/2-13 X 3/4	50	
JEA08032	1/2-13 X 1	50	
JEA08040X	1/2-13 X 1 1/4	50	
JEA08048	1/2-13 X 1 1/2	50	
JEA08056	1/2-13 X 1 3/4	50	
JEA08064	1/2-13 X 2	50	
JEA08096X	1/2-13 X 3	25	
JEA10040	5/8-11 X 1 1/4	25	
JEA10096	5/8-11 X 3	25	
JEA12048	3/4-10 X 1 1/2	10	

**BUTTON SOCKET CAP SCREW**

304 STAINLESS STEEL

Line: 1158-00

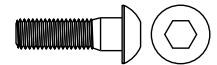

PART NUMBER	SIZE	QTY/BX	LIST PRICE
JJA22006	2/56 X 3/16	100	
JJA22008	2/56 X 1/4	100	
JJA44012	4/40 X 3/8	100	
JJA66008	6/32 X 1/4	100	
JJA66012	6/32 X 3/8	100	
JJA66016	6/32 X 1/2	100	
JJA66020	6/32 X 5/8	100	
JJA66024	6/32 X 3/4	100	
JJA88008X	8/32 X 1/4	100	
JJA88012	8/32 X 3/8	100	
JJA88014	8/32 X 7/16	100	
JJA88016	8/32 X 1/2	100	
JJA88024	8/32 X 3/4	100	
JJA88032	8/32 X 1	100	
JJA03008	10/24 X 1/4	100	
JJA03012	10/24 X 3/8	100	
JJA03016	10/24 X 1/2	100	
JJA03020	10/24 X 5/8	100	
JJA03024	10/24 X 3/4	100	
JJA03032	10/24 X 1	100	
JJA03008	10/32 X 1/4	100	
JJA03012	10/32 X 3/8	100	

(continued...)

**CALL: (800) 723-2826**

### BUTTON SOCKET CAP SCREW (cont.)

304 STAINLESS STEEL

Line: 1158-00

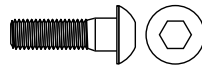

PART NUMBER	SIZE	QTY/BX	LIST PRICE
JJAS03016	10/32 X 1/2	100	
JJAS03020	10/32 X 5/8	100	
JJAS03024	10/32 X 3/4	100	
JJAS03032	10/32 X 1	100	
JJAS03040	10/32 X 1 1/4	100	
JJA04012	1/4-20 X 3/8	100	
JJA04016	1/4-20 X 1/2	100	
JJA04020	1/4-20 X 5/8	100	
JJA04024	1/4-20 X 3/4	100	
JJA04032	1/4-20 X 1	100	
JJA04040	1/4-20 X 1 1/4	100	
JJA04048	1/4-20 X 1 1/2	100	
JJA04056	1/4-20 X 1 3/4	100	
JJA04064	1/4-20 X 2	100	
JJA05016	5/16-18 X 1/2	100	
JJA05020	5/16-18 X 5/8	100	
JJA05024	5/16-18 X 3/4	100	
JJA05028	5/16-18 X 7/8	100	
JJA05032	5/16-18 X 1	100	
JJA05040	5/16-18 X 1 1/4	100	
JJA05048	5/16-18 X 1 1/2	100	
JJA05056	5/16-18 X 1 3/4	100	
JJA05064	5/16-18 X 2	100	
JJA06016	3/8-16 X 1/2	100	
JJA06020	3/8-16 X 5/8	100	
JJA06024	3/8-16 X 3/4	100	
JJA06032	3/8-16 X 1	100	
JJA06040	3/8-16 X 1 1/4	100	
JJA06048X	3/8-16 X 1 1/2	100	
JJA06056	3/8-16 X 1 3/4	50	
JJA06064	3/8-16 X 2	50	
JJAS06024	3/8-24 X 3/4	100	
JJA08024	1/2-13 X 3/4	50	
JJA08080	1/2-13 X 2 1/2	50	
JJA08096	1/2-13 X 3	50	

### SOCKET SET SCREW CUP POINT

304 STAINLESS STEEL

Line: 1159-00

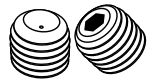

PART NUMBER	SIZE	QTY/BX	LIST PRICE
JPA22004	2/56 X 1/8	100	
JPA22005	2/56 X 5/32	100	
JPA22008	2/56 X 1/4	100	
JPA44004	4/40 X 1/8	100	
JPA44006	4/40 X 3/16	100	
JPA44008	4/40 X 1/4	100	
JPA44010	4/40 X 5/16	100	
JPA44012	4/40 X 3/8	100	
JPA55004	5/40 X 1/8	100	
JPA55008	5/40 X 1/4	100	
JPA55012	5/40 X 3/8	100	
JPA55016	5/40 X 1/2	100	
JPA66004	6/32 X 1/8	100	
JPA66006	6/32 X 3/16	100	
JPA66008	6/32 X 1/4	100	
JPA66010	6/32 X 5/16	100	
JPA66012	6/32 X 3/8	100	
JPA66016X	6/32 X 1/2	100	
JPA66020X	6/32 X 5/8	100	
JPA66024	6/32 X 3/4	100	
JPA88004	8/32 X 1/8	100	
JPA88006	8/32 X 3/16	100	
JPA88008	8/32 X 1/4	100	
JPA88010	8/32 X 5/16	100	
JPA88012	8/32 X 3/8	100	
JPA88016	8/32 X 1/2	100	
JPA03006	10/24 X 3/16	100	
JPA03008	10/24 X 1/4	100	
JPA03010	10/24 X 5/16	100	
JPA03012	10/24 X 3/8	100	
JPA03016	10/24 X 1/2	100	
JPA03020	10/24 X 5/8	100	
JPA03024	10/24 X 3/4	100	
JPA03032X	10/24 X 1	100	
JPA03040	10/24 X 1 1/4	100	
JPAS03004	10/32 X 1/8	100	
JPAS03006	10/32 X 3/16	100	
JPAS03008	10/32 X 1/4	100	
JPAS03010	10/32 X 5/16	100	
JPAS03012	10/32 X 3/8	100	

(continued...)

**SOCKET SET SCREW CUP POINT (cont.)**

304 STAINLESS STEEL

Line: 1159-00

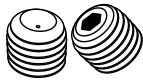

PART NUMBER	SIZE	QTY/BX	LIST PRICE
JPAS03016	10/32 X 1/2	100	
JPAS03020	10/32 X 5/8	100	
JPAS03024	10/32 X 3/4	100	
JPAS03032	10/32 X 1	100	
JPA04006	1/4-20 X 3/16	100	
JPA04008	1/4-20 X 1/4	100	
JPA04010	1/4-20 X 5/16	100	
JPA04012	1/4-20 X 3/8	100	
JPA04016	1/4-20 X 1/2	100	
JPA04020	1/4-20 X 5/8	100	
JPA04024	1/4-20 X 3/4	100	
JPA04032	1/4-20 X 1	100	
JPA04040X	1/4-20 X 1 1/4	100	
JPA04048X	1/4-20 X 1 1/2	100	
JPAS04006	1/4-28 X 3/16	100	
JPAS04008	1/4-28 X 1/4	100	
JPAS04010	1/4-28 X 5/16	100	
JPAS04012	1/4-28 X 3/8	100	
JPAS04016	1/4-28 X 1/2	100	
JPAS04020	1/4-28 X 5/8	100	
JPAS04024	1/4-28 X 3/4	100	
JPAS04032	1/4-28 X 1	100	
JPAS04048X	1/4-28 X 1 1/2	100	
JPA05008	5/16-18 X 1/4	100	
JPA05010	5/16-18 X 5/16	100	
JPA05012	5/16-18 X 3/8	100	
JPA05016	5/16-18 X 1/2	100	
JPA05020	5/16-18 X 5/8	100	
JPA05024	5/16-18 X 3/4	100	
JPA05028	5/16-18 X 7/8	100	
JPA05032	5/16-18 X 1	100	
JPA05040X	5/16-18 X 1 1/4	100	
JPA05048X	5/16-18 X 1 1/2	100	
JPA05064	5/16-18 X 2	50	
JPAS05008	5/16-24 X 1/4	100	
JPAS05012	5/16-24 X 3/8	100	
JPAS05016	5/16-24 X 1/2	100	
JPAS05020	5/16-24 X 5/8	100	
JPAS05024	5/16-24 X 3/4	100	
JPAS05032	5/16-24 X 1	100	

(continued...)

**SOCKET SET SCREW CUP POINT (cont.)**

304 STAINLESS STEEL

Line: 1159-00



PART NUMBER	SIZE	QTY/BX	LIST PRICE
JPA06008	3/8-16 X 1/4	100	
JPA06010	3/8-16 X 5/16	100	
JPA06012	3/8-16 X 3/8	100	
JPA06016	3/8-16 X 1/2	100	
JPA06020	3/8-16 X 5/8	100	
JPA06024	3/8-16 X 3/4	100	
JPA06028	3/8-16 X 7/8	100	
JPA06032	3/8-16 X 1	100	
JPA06056	3/8-16 X 1 3/4	50	
JPAS06012	3/8-24 X 3/8	100	
JPAS06016	3/8-24 X 1/2	100	
JPAS06020	3/8-24 X 5/8	100	
JPAS06024	3/8-24 X 3/4	100	
JPAS06032	3/8-24 X 1	50	
JPA07012	7/16-14 X 3/8	50	
JPA07016X	7/16-14 X 1/2	50	
JPA07024	7/16-14 X 3/4	50	
JPA08012	1/2-13 X 3/8	100	
JPA08016	1/2-13 X 1/2	100	
JPA08020	1/2-13 X 5/8	100	
JPA08024	1/2-13 X 3/4	50	
JPA08028	1/2-13 X 7/8	50	
JPA08032	1/2-13 X 1	50	
JPA08040	1/2-13 X 1 1/4	50	
JPA08048X	1/2-13 X 1 1/2	50	
JPA08064	1/2-13 X 2	50	
JPA08080	1/2-13 X 2 1/2	25	
JPAS08016	1/2-20 X 1/2	100	
JPA10016X	5/8-11 X 1/2	25	
JPA10020X	5/8-11 X 5/8	25	
JPA10024X	5/8-11 X 3/4	25	
JPA10032	5/8-11 X 1	50	
JPA10040	5/8-11 X 1 1/4	25	
JPA10048	5/8-11 X 1 1/2	25	
JPA12064	3/4-10 X 2	25	

## SOCKET SHOULDER SCREW

304 STAINLESS STEEL

Line: 1160-02



PART NUMBER	SIZE	QTY/BX	LIST PRICE
JFK04016	1/4 X 1/2	25	
JFK04032	1/4 X 1 (10/24 THREAD)	25	
JFK05008X	5/16 X 1/4	25	
JFK05012	5/16 X 3/8	25	
JFK05016	5/16 X 1/2	25	
JFK05020	5/16 X 5/8	25	
JFK05024	5/16 X 3/4	25	
JFK05040	5/16 X 1 1/4	25	
JFK06012X	3/8 X 3/8	25	
JFK06032X	3/8 X 1	25	
JFK06040	3/8 X 1 1/4	25	
JFK06048	3/8 X 1 1/2	25	
JFK08020	1/2 X 5/8	25	
JFK08024	1/2 X 3/4	25	
JFK08032	1/2 X 1	25	
JFK12064	3/4 X 2	1	

## SQUARE HEAD SET SCREW CUP POINT

304 STAINLESS STEEL

Line: 1161-00



PART NUMBER	SIZE	QTY/BX	LIST PRICE
KGA04016	1/4-20 X 1/2	100	
KGA04020	1/4-20 X 5/8	100	
KGA04024	1/4-20 X 3/4	100	
KGA04032	1/4-20 X 1	100	
KGA04040	1/4-20 X 1 1/4	100	
KGA04048	1/4-20 X 1 1/2	100	
KGA05016	5/16-18 X 1/2	100	
KGA05020	5/16-18 X 5/8	100	
KGA05024	5/16-18 X 3/4	100	
KGA05032	5/16-18 X 1	100	
KGA05040	5/16-18 X 1 1/4	100	
KGA06016	3/8-16 X 1/2	100	
KGA06020	3/8-16 X 5/8	100	
KGA06024	3/8-16 X 3/4	100	
KGA06032	3/8-16 X 1	100	
KGA06040	3/8-16 X 1 1/4	100	
KGA06048	3/8-16 X 1 1/2	50	
KGA06056	3/8-16 X 1 3/4	50	
KGA06064	3/8-16 X 2	50	
KGA08024	1/2-13 X 3/4	50	

(continued...)

## SQUARE HEAD SET SCREW CUP POINT (cont.)

304 STAINLESS STEEL

Line: 1161-00



PART NUMBER	SIZE	QTY/BX	LIST PRICE
KGA08032	1/2-13 X 1	50	
KGA08040	1/2-13 X 1 1/4	50	
KGA08048	1/2-13 X 1 1/2	50	
KGA08064	1/2-13 X 2	50	
KGA08080	1/2-13 X 2 1/2	25	
KGA08096X	1/2-13 X 3	25	
KGA10048X	5/8-11 X 1 1/2	25	
KGA10064	5/8-11 X 2	25	
KGA12040X	3/4-10 X 1 1/4	25	
KGA12048X	3/4-10 X 1 1/2	25	
KGA16112	1-8 X 3 1/2	5	

## SOCKET SET SCREW CUP POINT

BRASS

Line: 1161-03

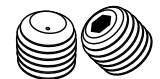

PART NUMBER	SIZE	QTY/BX	LIST PRICE
JUH04008X	1/4-20 X 1/4	100	
JUH06016X	3/8-16 X 1/2	100	
JUH08016X	1/2-13 X 1/2	100	
JUH08020X	1/2-13 X 5/8	100	
JUH08024X	1/2-13 X 3/4	100	
JUH10016X	5/8-11 X 1/2	50	
JUH10020X	5/8-11 X 5/8	25	
JUH10024X	5/8-11 X 3/4	25	

## SOCKET SET SCREW CUP POINT

SILICON BRONZE

Line: 1161-04

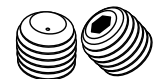

PART NUMBER	SIZE	QTY/BX	LIST PRICE
JCJ04016X	1/4-20 X 1/2	100	
JCJ05024X	5/16-18 X 3/4	100	
JCJ05032X	5/16-18 X 1	100	
JCJ05048X	5/16-18 X 1 1/2	100	
JCJ05064X	5/16-18 X 2	100	
JCJ06048X	3/8-16 X 1 1/2	100	



**DOWEL PINS**

304 STAINLESS STEEL

Line: 1162-00



PART NUMBER	SIZE	QTY/BX	LIST PRICE
KSA93012	3/32 X 3/8	100	
KSA93016	3/32 X 1/2	100	
KSA02008	1/8 X 1/4	100	
KSA02012	1/8 X 3/8	100	
KSA02016	1/8 X 1/2	100	
KSA02020	1/8 X 5/8	100	
KSA02024	1/8 X 3/4	100	
KSA02028	1/8 X 7/8	100	
KSA02032	1/8 X 1	100	
KSA02040	1/8 X 1 1/4	100	
KSA02048	1/8 X 1 1/2	100	
KSA03008	3/16 X 1/4	100	
KSA03012	3/16 X 3/8	100	
KSA03016	3/16 X 1/2	100	
KSA03020	3/16 X 5/8	100	
KSA03024	3/16 X 3/4	100	
KSA03028	3/16 X 7/8	100	
KSA03032	3/16 X 1	100	
KSA03040	3/16 X 1 1/4	100	
KSA03048	3/16 X 1 1/2	100	
KSA03056	3/16 X 1 3/4	100	
KSA03064	3/16 X 2	100	
KSA04016	1/4 X 1/2	100	
KSA04020	1/4 X 5/8	100	
KSA04024	1/4 X 3/4	100	
KSA04028	1/4 X 7/8	100	
KSA04032	1/4 X 1	100	
KSA04040	1/4 X 1 1/4	100	
KSA04048	1/4 X 1 1/2	100	
KSA04056	1/4 X 1 3/4	100	
KSA04064	1/4 X 2	100	
KSA04080	1/4 X 2 1/2	100	
KSA04096	1/4 X 3	100	
KSA05016	5/16 X 1/2	100	
KSA05020	5/16 X 5/8	100	
KSA05024	5/16 X 3/4	100	
KSA05028	5/16 X 7/8	100	
KSA05032	5/16 X 1	100	
KSA05040	5/16 X 1 1/4	100	
KSA05048	5/16 X 1 1/2	100	

(continued...)

**DOWEL PINS (cont.)**

304 STAINLESS STEEL

Line: 1162-00



PART NUMBER	SIZE	QTY/BX	LIST PRICE
KSA05056	5/16 X 1 3/4	100	
KSA05064	5/16 X 2	100	
KSA05080	5/16 X 2 1/2	100	
KSA05096	5/16 X 3	100	
KSA06016	3/8 X 1/2	100	
KSA06020	3/8 X 5/8	100	
KSA06024	3/8 X 3/4	100	
KSA06032	3/8 X 1	100	
KSA06040	3/8 X 1 1/4	100	
KSA06048	3/8 X 1 1/2	100	
KSA06056	3/8 X 1 3/4	25	
KSA06064	3/8 X 2	25	
KSA06080	3/8 X 2 1/2	25	
KSA06096	3/8 X 3	25	
KSA08064	1/2 X 2	25	

**TENSION SPLIT PINS**

STAINLESS STEEL

Line: 1163-00

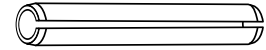

PART NUMBER	SIZE	QTY/BX	LIST PRICE
KVA01008	1/16 X 1/4	100	
KVA01012	1/16 X 3/8	100	
KVA01016	1/16 X 1/2	100	
KVA01020	1/16 X 5/8	100	
KVA01024	1/16 X 3/4	100	
KVA01032	1/16 X 1	100	
KVA78012	5/64 X 3/8	100	
KVA78016	5/64 X 1/2	100	
KVA78024	5/64 X 3/4	100	
KVA78032	5/64 X 1	100	
KVA93012	3/32 X 3/8	100	
KVA93016	3/32 X 1/2	100	
KVA93020	3/32 X 5/8	100	
KVA93024	3/32 X 3/4	100	
KVA93028	3/32 X 7/8	100	
KVA93032	3/32 X 1	100	
KVA93048	3/32 X 1 1/2	100	
KVA02012	1/8 X 3/8	100	
KVA02014	1/8 X 7/16	100	
KVA02016	1/8 X 1/2	100	
KVA02020	1/8 X 5/8	100	

(continued...)

**CALL: (800) 723-2826**

**TENSION SPLIT PINS (cont.)**

STAINLESS STEEL

Line: 1163-00

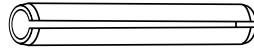

PART NUMBER	SIZE	QTY/BX	LIST PRICE
KVA02024	1/8 X 3/4	100	
KVA02028	1/8 X 7/8	100	
KVA02032	1/8 X 1	100	
KVA02036	1/8 X 1 1/8	100	
KVA02040	1/8 X 1 1/4	100	
KVA02048	1/8 X 1 1/2	100	
KVA02064	1/8 X 2	100	
KVA156016	5/32 X 1/2	25	
KVA156024	5/32 X 3/4	100	
KVA156028	5/32 X 7/8	100	
KVA156032	5/32 X 1	100	
KVA156048	5/32 X 1 1/2	50	
KVA156064	5/32 X 2	50	
KVA03016	3/16 X 1/2	100	
KVA03020	3/16 X 5/8	100	
KVA03024	3/16 X 3/4	100	
KVA03028	3/16 X 7/8	100	
KVA03032	3/16 X 1	100	
KVA03036	3/16 X 1 1/8	100	
KVA03040	3/16 X 1 1/4	100	
KVA03044	3/16 X 1 3/8	100	
KVA03048	3/16 X 1 1/2	50	
KVA03056	3/16 X 1 3/4	50	
KVA03064	3/16 X 2	50	
KVA03072	3/16 X 2 1/4	50	
KVA03080	3/16 X 2 1/2	50	
KVA21024	7/32 X 3/4	25	
KVA21032	7/32 X 1	25	
KVA21040	7/32 X 1 1/4	25	
KVA21044	7/32 X 1 3/8	25	
KVA21048	7/32 X 1 1/2	25	
KVA21064	7/32 X 2	25	
KVA21080	7/32 X 2 1/2	25	
KVA04024	1/4 X 3/4	50	
KVA04032	1/4 X 1	50	
KVA04036	1/4 X 1 1/8	50	
KVA04040	1/4 X 1 1/4	50	
KVA04044	1/4 X 1 3/8	50	
KVA04048	1/4 X 1 1/2	25	
KVA04056	1/4 X 1 3/4	25	

(continued...)

**TENSION SPLIT PINS (cont.)**

STAINLESS STEEL

Line: 1163-00

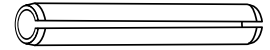

PART NUMBER	SIZE	QTY/BX	LIST PRICE
KVA04064	1/4 X 2	25	
KVA04072	1/4 X 2 1/4	25	
KVA04080	1/4 X 2 1/2	25	
KVA04096	1/4 X 3	25	
KVA05024	5/16 X 3/4	25	
KVA05032	5/16 X 1	25	
KVA05040	5/16 X 1 1/4	25	
KVA05056	5/16 X 1 3/4	25	
KVA05064	5/16 X 2	25	
KVA05096	5/16 X 3	25	
KVA05112	5/16 X 3 1/2	25	
KVA05120	5/16 X 3 3/4	25	
KVA05128	5/16 X 4	25	
KVA06032	3/8 X 1	25	
KVA06048	3/8 X 1 1/2	25	
KVA06056	3/8 X 1 3/4	25	
KVA06064	3/8 X 2	25	
KVA06072	3/8 X 2 1/4	25	
KVA06080	3/8 X 2 1/2	25	
KVA06096	3/8 X 3	25	
KVA07032	7/16 X 1	25	
KVA07064	7/16 X 2	50	
KVA07096	7/16 X 3	25	
KVA08040	1/2 X 1 1/4	25	
KVA08064	1/2 X 2	25	
KVA08080	1/2 X 2 1/2	25	
KVA08096	1/2 X 3	25	
KVA08128	1/2 X 4	25	

**COTTER PINS**

STAINLESS STEEL

Line: 1164-00

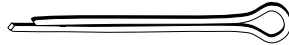

PART NUMBER	SIZE	QTY/BX	LIST PRICE
LBA31012	1/32 X 3/8	100	
LBA31016	1/32 X 1/2	100	
LBA31024	1/32 X 3/4	100	
LBA31032	1/32 X 1	100	
LBA46012X	3/64 X 3/8	100	
LBA46016	3/64 X 1/2	100	
LBA46024	3/64 X 3/4	100	
LBA46032	3/64 X 1	100	
LBA01016	1/16 X 1/2	100	
LBA01024	1/16 X 3/4	100	
LBA01032	1/16 X 1	100	
LBA01040	1/16 X 1 1/4	100	
LBA01048	1/16 X 1 1/2	100	
LBA78016	5/64 X 1/2	100	
LBA78024	5/64 X 3/4	100	
LBA78032	5/64 X 1	100	
LBA78040	5/64 X 1 1/4	100	
LBA78048	5/64 X 1 1/2	100	
LBA93012	3/32 X 3/8	100	
LBA93016	3/32 X 1/2	100	
LBA93024	3/32 X 3/4	100	
LBA93032	3/32 X 1	100	
LBA93040	3/32 X 1 1/4	100	
LBA93048	3/32 X 1 1/2	100	
LBA93056	3/32 X 1 3/4	100	
LBA93064	3/32 X 2	100	
LBA109032X	7/64 X 1	100	
LBA02020	1/8 X 5/8	100	
LBA02024	1/8 X 3/4	100	
LBA02032	1/8 X 1	100	
LBA02040	1/8 X 1 1/4	100	
LBA02048	1/8 X 1 1/2	100	
LBA02056	1/8 X 1 3/4	100	
LBA02064	1/8 X 2	100	
LBA02080	1/8 X 2 1/2	100	
LBA02096	1/8 X 3	100	
LBA02112	1/8 X 3 1/2	100	
LBA156024	5/32 X 3/4	100	
LBA156032X	5/32 X 1	100	
LBA156040	5/32 X 1 1/4	100	

(continued...)

**COTTER PINS (cont.)**

STAINLESS STEEL

Line: 1164-00

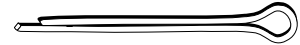

PART NUMBER	SIZE	QTY/BX	LIST PRICE
LBA156048	5/32 X 1 1/2	100	
LBA156056	5/32 X 1 3/4	100	
LBA156064	5/32 X 2	100	
LBA156080	5/32 X 2 1/2	100	
LBA156096	5/32 X 3	100	
LBA03020	3/16 X 5/8	100	
LBA03024	3/16 X 3/4	100	
LBA03032	3/16 X 1	100	
LBA03040	3/16 X 1 1/4	100	
LBA03048	3/16 X 1 1/2	100	
LBA03056	3/16 X 1 3/4	100	
LBA03064	3/16 X 2	100	
LBA03080	3/16 X 2 1/2	100	
LBA03096	3/16 X 3	100	
LBA04032	1/4 X 1	100	
LBA04040	1/4 X 1 1/4	50	
LBA04048	1/4 X 1 1/2	50	
LBA04056	1/4 X 1 3/4	50	
LBA04064	1/4 X 2	50	
LBA04080	1/4 X 2 1/2	50	
LBA04096	1/4 X 3	50	
LBA05048	5/16 X 1 1/2	50	
LBA05064	5/16 X 2	50	
LBA05080	5/16 X 2 1/2	50	
LBA05096	5/16 X 3	50	
LBA06048	3/8 X 1 1/2	50	
LBA06064	3/8 X 2	50	
LBA06080	3/8 X 2 1/2	50	
LBA06096	3/8 X 3	50	



**CALL - 1 (800) 723-2826**

**CALL: (800) 723-2826**

## COTTER PINS

BRASS

Line: 1165-00

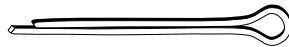

PART NUMBER	SIZE	QTY/BX	LIST PRICE
LCA01016	1/16 X 1/2	100	
LCA01024	1/16 X 3/4	100	
LCA01032	1/16 X 1	100	
LCA01040	1/16 X 1 1/4	100	
LCA01048	1/16 X 1 1/2	100	
LCA93016	3/32 X 1/2	100	
LCA93024	3/32 X 3/4	100	
LCA93032	3/32 X 1	100	
LCA93040	3/32 X 1 1/4	100	
LCA93048	3/32 X 1 1/2	100	
LCA02024	1/8 X 3/4	100	
LCA02032	1/8 X 1	100	
LCA02040	1/8 X 1 1/4	100	
LCA02048	1/8 X 1 1/2	100	
LCA02064	1/8 X 2	100	
LCA156032	5/32 X 1	100	
LCA156040	5/32 X 1 1/4	100	
LCA156048	5/32 X 1 1/2	100	
LCA156064	5/32 X 2	100	
LCA156096	5/32 X 3	100	
LCA03024	3/16 X 3/4	100	
LCA03032	3/16 X 1	100	
LCA03040	3/16 X 1 1/4	100	
LCA03048	3/16 X 1 1/2	100	
LCA03064	3/16 X 2	100	
LCA03080	3/16 X 2 1/2	50	
LCA03096	3/16 X 3	50	
LCA04064	1/4 X 2	100	
LCA04080	1/4 X 2 1/2	50	
LCA04096	1/4 X 3	50	

## THREADED ROD

304 STAINLESS STEEL

Line: 1166-00



PART NUMBER	SIZE	QTY/BX	LIST PRICE
KYA4403F	4/40 X 3'	1	
KYA5503F	5/40 X 3'	1	
KYA6603F	6/32 X 3'	1	
KYA8803F	8/32 X 3'	1	
KYA0303F	10/24 X 3'	1	
KYAS0303F	10/32 X 3'	1	
KYA2103F	12/24 X 3'	1	
KYA0403F	1/4-20 X 3'	1	
KYA0406F	1/4-20 X 6'	1	
KYAS0403F	1/4-28 X 3'	1	
KYA0503F	5/16-18 X 3'	1	
KYA0506F	5/16-18 X 6'	1	
KYAS0503F	5/16-24 X 3'	1	
KYA0603F	3/8-16 X 3'	1	
KYA0606FX	3/8-16 X 6'	1	
KYA0612F	3/8-16 X 12'	1	
KYAS0603F	3/8-24 X 3'	1	
KYA0703F	7/16-14 X 3'	1	
KYA0706F	7/16-14 X 6'	1	
KYA0712F	7/16-14 X 12'	1	
KYAS0703F	7/16-20 X 3'	1	
KYA0803F	1/2-13 X 3'	1	
KYA0806FX	1/2-13 X 6'	1	
KYA0812F	1/2-13 X 12'	1	
KYAS0803F	1/2-20 X 3'	1	
KYA0903F	9/16-12 X 3'	1	
KYA0906FX	9/16-12 X 6'	1	
KYAS0903F	9/16-18 X 3'	1	
KYA1003F	5/8-11 X 3'	1	
KYA1006F	5/8-11 X 6'	1	
KYA1012F	5/8-11 X 12'	1	
KYAS1003F	5/8-18 X 3'	1	
KYA1203F	3/4-10 X 3'	1	
KYA1206F	3/4-10 X 6'	1	
KYA1212F	3/4-10 X 12'	1	
KYAS1203F	3/4-16 X 3'	1	
KYAS1403F	7/8-14 X 3'	1	
KYA1403F	7/8-9 X 3'	1	
KYA1406F	7/8-9 X 6'	1	

(continued...)

**THREADED ROD (cont.)**

304 STAINLESS STEEL

Line: 1166-00



PART NUMBER	SIZE	QTY/BX	LIST PRICE
KYA1412F	7/8-9 X 12'	1	
KYA1603F	1-8 X 3'	1	
KYA1606F	1-8 X 6'	1	
KYA1612F	1-8 X 12'	1	
KYAS1603F	1-14 X 3'	1	
KYAS1803F	1 1/8-12 X 3'	1	
KYAS1806F	1 1/8-12 X 6'	1	
KYA1803F	1 1/8-7 X 3'	1	
KYA1806F	1 1/8-7 X 6'	1	
KYA1812F	1 1/8-7 X 12'	1	
KYAS2003F	1 1/4-12 X 3'	1	
KYAS2006F	1 1/4-12 X 6'	1	
KYA2003F	1 1/4-7 X 3'	1	
KYA2006F	1 1/4-7 X 6'	1	
KYA2012F	1 1/4-7 X 12'	1	
KYAN2003F	1 1/4-8 X 3'	1	
KYAS2203F	1 3/8-12 X 3'	1	
KYAS2206F	1 3/8-12 X 6'	1	
KYA2203F	1 3/8-6 X 3'	1	
KYA2206F	1 3/8-6 X 6'	1	
KYA2212F	1 3/8-6 X 12'	1	
KYAS2403F	1 1/2-12 X 3'	1	
KYAS2406F	1 1/2-12 X 6'	1	
KYA2403F	1 1/2-6 X 3'	1	
KYA2406F	1 1/2-6 X 6'	1	
KYA2412F	1 1/2-6 X 12'	1	
KYAS2803F	1 3/4-12 X 3'	1	
KYAS2806F	1 3/4-12 X 6'	1	
KYA2803F	1 3/4-5 X 3'	1	
KYA2806F	1 3/4-5 X 6'	1	
KYA2812F	1 3/4-5 X 12'	1	
KYA3203F	2-4 1/2 X 3'	1	
KYA3206F	2-4 1/2 X 6'	1	
KYA3212F	2-4 1/2 X 12'	1	
KYAS3203F	2-12 X 3'	1	
KYAS3206F	2-12 X 6'	1	

**ROUND HEAD U-DRIVE SCREW**

304 STAINLESS STEEL

Line: 1167-00

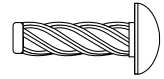

PART NUMBER	SIZE	QTY/BX	LIST PRICE
ZVB00004	00 X 1/8	1000	
ZVB00006	00 X 3/16	1000	
ZVB00008	00 X 1/4	1000	
ZVB00004	0 X 1/8	1000	
ZVB00006	0 X 3/16	1000	
ZVB00008	0 X 1/4	1000	
ZVB2004	2 X 1/8	1000	
ZVB2006	2 X 3/16	1000	
ZVB2008	2 X 1/4	1000	
ZVB4004	4 X 1/8	1000	
ZVB4006	4 X 3/16	1000	
ZVB4008	4 X 1/4	1000	
ZVB4010	4 X 5/16	1000	
ZVB4012	4 X 3/8	1000	
ZVB6008	6 X 1/4	500	
ZVB6010	6 X 5/16	500	
ZVB6012	6 X 3/8	500	
ZVB8008	8 X 1/4	500	
ZVB8012	8 X 3/8	500	
ZVB8016	8 X 1/2	500	
ZVB8020	8 X 5/8	500	
ZVB10012	10 X 3/8	500	
ZVB10016	10 X 1/2	500	
ZVB10020	10 X 5/8	500	

**THREADED ROD**

316 STAINLESS STEEL

Line: 1169-00



PART NUMBER	SIZE	QTY/BX	LIST PRICE
LEA25603F	2/56 X 3'	1	
LEA4403F	4/40 X 3'	1	
LEA6603F	6/32 X 3'	1	
LEA8803F	8/32 X 3'	1	
LEA0303F	10/24 X 3'	1	
LEAS0303F	10/32 X 3'	1	
LEA2103F	12/24 X 3'	1	
LEA0403F	1/4-20 X 3'	1	
LEA0406F	1/4-20 X 6'	1	
LEAS0403F	1/4-28 X 3'	1	
LEA0503F	5/16-18 X 3'	1	

(continued...)

**THREADED ROD (cont.)**

316 STAINLESS STEEL

Line: 1169-00

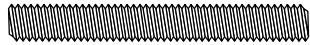

PART NUMBER	SIZE	QTY/BX	LIST PRICE
LEA0506F	5/16-18 X 6'	1	
LEA0503F	5/16-24 X 3'	1	
LEA0603F	3/8-16 X 3'	1	
LEA0606F	3/8-16 X 6'	1	
LEA0612F	3/8-16 X 12'	1	
LEA0603F	3/8-24 X 3'	1	
LEA0703F	7/16-14 X 3'	1	
LEA0803F	1/2-13 X 3'	1	
LEA0806F	1/2-13 X 6'	1	
LEA0812F	1/2-13 X 12'	1	
LEAS0803F	1/2-20 X 3'	1	
LEA1003F	5/8-11 X 3'	1	
LEA1006F	5/8-11 X 6'	1	
LEA1012F	5/8-11 X 12'	1	
LEAS1003F	5/8-18 X 3'	1	
LEA1203F	3/4-10 X 3'	1	
LEA1206F	3/4-10 X 6'	1	
LEA1212F	3/4-10 X 12'	1	
LEAS1203F	3/4-16 X 3'	1	
LEA1403F	7/8-9 X 3'	1	
LEA1406F	7/8-9 X 6'	1	
LEA1412F	7/8-9 X 12'	1	
LEA1603F	1-8 X 3'	1	
LEA1606F	1-8 X 6'	1	
LEA1612F	1-8 X 12'	1	
LEA1803F	1 1/8-7 X 3'	1	
LEA1806F	1 1/8-7 X 6'	1	
LEA1812F	1 1/8-7 X 12'	1	
LEAS1803F	1 1/8-8 X 3'	1	
LEAS1806F	1 1/8-8 X 6'	1	
LEA2003F	1 1/4-7 X 3'	1	
LEA2006F	1 1/4-7 X 6'	1	
LEA2012F	1 1/4-7 X 12'	1	
LEAS2003F	1 1/4-8 X 3'	1	
LEAS2006F	1 1/4-8 X 6'	1	
LEA2203F	1 3/8-6 X 3'	1	
LEA2206F	1 3/8-6 X 6'	1	
LEA2212F	1 3/8-6 X 12'	1	
LEAS2203F	1 3/8-8 X 3'	1	

(continued...)

**THREADED ROD (cont.)**

316 STAINLESS STEEL

Line: 1169-00



PART NUMBER	SIZE	QTY/BX	LIST PRICE
LEAS2206F	1 3/8-8 X 6'	1	
LEA2403F	1 1/2-6 X 3'	1	
LEA2406F	1 1/2-6 X 6'	1	
LEA2412F	1 1/2-6 X 12'	1	
LEAS2403F	1 1/2-8 X 3'	1	
LEAS2406F	1 1/2-8 X 6'	1	
LEA2803F	1 3/4-5 X 3'	1	
LEA2806F	1 3/4-5 X 6'	1	
LEAS2803F	1 3/4-8 X 3'	1	
LEAS2806F	1 3/4-8 X 6'	1	
LEA3203F	2-4 1/2 X 3'	1	
LEA3206F	2-4 1/2 X 6'	1	
LEAS3203F	2-8 X 3'	1	
LEAS3206F	2-8 X 6'	1	

**THREADED ROD**

BRASS

Line: 1170-00



PART NUMBER	SIZE	QTY/BX	LIST PRICE
KZA6603F	6/32 X 3'	1	
KZA8803F	8/32 X 3'	1	
KZA0303F	10/24 X 3'	1	
KZAS0303F	10/32 X 3'	1	
KZA0403F	1/4-20 X 3 FT	1	
KZA0503F	5/16-18 X 3 FT	1	
KZA0603F	3/8-16 X 3 FT	1	
KZA0703F	7/16-14 X 3 FT	1	
KZA0803F	1/2-13 X 3 FT	1	
KZA0903F	9/16-12 X 3FT	1	
KZA1003F	5/8-11 X 3 FT	1	
KZA1203F	3/4-10 X 3 FT	1	

**NOTE: 12 FOOT RODS ARE NOT SHIPPED BY UPS - ONLY BY TRUCK @ MINIMUM TRUCK RATES**

## ROUND STOCK

BRASS

Line: 1171-00



PART NUMBER	SIZE	QTY/BX	LIST PRICE
WCB1603F	1 X 3 FT	1	
WCB0303F	3/16 X 3 FT	1	
WCB0403F	1/4 X 3 FT	1	
WCB0503F	5/16 X 3 FT	1	
WCB0603F	3/8 X 3 FT	1	
WCB0703F	7/16 X 3 FT	1	
WCB0803F	1/2 X 3 FT	1	
WCB1003F	5/8 X 3 FT	1	
WCB1203F	3/4 X 3 FT	1	

## THREADED ROD

ALUMINUM

Line: 1172-00



PART NUMBER	SIZE	QTY/BX	LIST PRICE
LDA0303F	10-24 X 3 FT	1	
LDA6603F	6-32 X 3 FT	1	
LDA0403F	1/4-20 X 3 FT	1	
LDA0406F	1/4-20 X 6 FT	1	
LDA0503F	5/16-18 X 3 FT	1	
LDA0603F	3/8-16 X 3 FT	1	
LDA0803F	1/2-13 X 3 FT	1	



**CALL - 1 (800) 723-2826**

**CALL: (800) 723-2826**

# SECTION 14 PRODUCT INDEX



## GREASE FITTINGS

Line Description	Alpha	Line#	Page#
GREASE FITTINGS - STRAIGHT	PXB	1175-00	14-6
GREASE FITTINGS - STRAIGHT DRIVE	PXB	1176-00	14-6
GREASE FITTINGS - 45° ELBOW	PYB	1179-00	14-6
GREASE FITTINGS - 90° ELBOW	PZB	1182-00	14-6
GREASE FITTINGS - 30° ELBOW	RAB	1184-00	14-6
GREASE FITTINGS - 65° ELBOW	RBB	1187-00	14-6
GREASE FITTINGS - 65° ELBOW	RCB	1188-00	14-6
GREASE FITTINGS - 65° DRIVE ELBOW	RCB	1189-00	14-6
GREASE FITTINGS - STRAIGHT MALE BUTTON	RDB	1192-00	14-6
GREASE FITTINGS - METRIC STRAIGHT	FDD	1194-00	14-6
GREASE FITTINGS - METRIC 45° ELBOW	FDD	1195-00	14-7
GREASE FITTINGS - METRIC 90° ELBOW	FDD	1196-00	14-7
GREASE FITTING - ANGLE DRIVING TOOL	REB	1198-00	14-7
GREASE WHIP HOSE 1/8 NPT W/SPRING GARD	REB	1202-00	14-7
GREASE GUN FILLER NIPPLE	REB	1203-00	14-7
LINCOLN FITTINGS ADAPTERS & TOOLS	JKY	1203-01	14-7
HAND PUMP PORTABLE GREASE GUN	REB	1204-00	14-7
HEAVY DUTY GREASE COUPLER	REB	1206-00	14-7
BUTTON GREASE COUPLER LARGE AND STANDARD	REB	1209-00	14-7
GREASE FITTING - STRAIGHT DRIVING TOOL	REB	1210-00	14-7
THIN NOSE GREASE COUPLERS	REB	1212-00	14-7
GREASE ADAPTER TUBES 30°	REB	1214-00	14-7
HI-PRESSURE SWIVEL GREASE COUPLER	GFD	1216-00	14-7
STRAIGHT VENTED GREASE FITTING	GFD	1222-00	14-8
PRESSURE RELIEF VALVE 1/8 NPT	GFD	1226-00	14-8
45° STREET ELBOW ADAPTER	GFD	1227-00	14-8
90° STREET ELBOW ADAPTER	GFD	1233-00	14-8

## ELECTRICAL

Line Description	Alpha	Line#	Page#
3M VINYL INSULATED RING WIRE TERMINAL	RFB	1242-00	14-8
3M VINYL INSULATED SPADE WIRE TERMINAL	RGB	1243-00	14-9
3M VINYL INSULATED FLANGE SPADE WIRE TERMINAL	RHB	1244-00	14-9
3M VINYL INSULATED HOOK WIRE TERMINAL	RJB	1245-00	14-9
3M VINYL INSULATED BLOCK SPADE WIRE TERMINAL	RKB	1246-00	14-9
3M VINYL INSULATED FLANGE BLOCK SPADE WIRE TERMINAL	RLB	1247-00	14-9
3M VINYL INSULATED 3-WAY WIRE TERMINAL	RVB	1248-00	14-9
3M VINYL INSULATED 4-WAY WIRE TERMINAL	RWB	1249-00	14-9
3M VINYL INSULATED FEMALE QUICK SLIDE WIRE TERMINAL	RYB	1250-00	14-10

(CONTINUED...)



# SECTION 14 PRODUCT INDEX



## ELECTRICAL (continued)

Line Description	Alpha	Line#	Page#
3M VINYL INSULATED MALE QUICK SLIDE WIRE TERMINAL	<b>RZB</b>	<b>1251-00</b>	14-10
3M VINYL INSULATED CROSS LOK WIRE TERMINAL	<b>SBB</b>	<b>1253-00</b>	14-10
3M VINYL INSULATED SNAP PLUG WIRE TERMINAL	<b>SKB</b>	<b>1254-00</b>	14-10
3M VINYL INSULATED BUTT CONNECTOR WIRE TERMINAL	<b>RXB</b>	<b>1256-00</b>	14-10
3M VINYL INSULATED MULTI STUD RING WIRE TERMINAL	<b>FKD</b>	<b>1258-00</b>	14-10
3M VINYL INSULATED SNAP SPADE WIRE TERMINAL	<b>FLD</b>	<b>1259-00</b>	14-10
PLAIN NON-INSULATED RING WIRE TERMINAL	<b>RMB</b>	<b>1260-00</b>	14-11
PLAIN NON-INSULATED SPADE WIRE TERMINAL	<b>RNB</b>	<b>1261-00</b>	14-11
PLAIN NON-INSULATED HOOK WIRE TERMINAL	<b>RPB</b>	<b>1262-00</b>	14-11
PLAIN NON-INSULATED FLANGE SPADE WIRE TERMINAL	<b>RRB</b>	<b>1263-00</b>	14-12
PLAIN NON-INSULATED RING FLAG WIRE TERMINAL	<b>RSB</b>	<b>1264-00</b>	14-12
PLAIN NON-INSULATED SPADE FLAG WIRE TERMINAL	<b>RTB</b>	<b>1265-00</b>	14-12
TIN PLATED NON-INSULATED BUTT CONNECTOR WIRE TERMINAL	<b>SDB</b>	<b>1267-00</b>	14-12
PLAIN NON-INSULATED FEMALE QUICK SLIDE WIRE TERMINAL	<b>SEB</b>	<b>1268-00</b>	14-12
PLAIN NON-INSULATED MALE QUICK SLIDE WIRE TERMINAL	<b>SFB</b>	<b>1269-00</b>	14-12
PLAIN NON-INSULATED SNAP PLUG WIRE TERMINAL	<b>SJB</b>	<b>1271-00</b>	14-12
PLAIN NON-INSULATED MULTI-STUD RING WIRE TERMINAL	<b>FSD</b>	<b>1272-00</b>	14-12
THERMAL LUGS HEAVY DUTY CABLE RINGS - TINNED	<b>SVB</b>	<b>1273-00</b>	14-13
COLOR CODED LUGS HEAVY DUTY CABLE RINGS - TINNED	<b>SVB</b>	<b>1273-01</b>	14-13
PLAIN NON-INSULATED BLOCK SPADE WIRE TERMINALS	<b>FVD</b>	<b>1274-00</b>	14-13
PLAIN NON-INSULATED FLANGE BLOCK SPADE WIRE TERMINALS	<b>FWD</b>	<b>1276-00</b>	14-14
PLAIN NON-INSULATED SNAP SPADE WIRE TERMINALS	<b>FXD</b>	<b>1277-00</b>	14-14
PLAIN NON-INSULATED CROSS WIRE TERMINALS	<b>FYD</b>	<b>1278-00</b>	14-14
3M NYLON INSULATED RING WIRE TERMINAL	<b>JKL</b>	<b>1278-01</b>	14-14
3M NYLON INSULATED SPADE WIRE TERMINAL	<b>JZP</b>	<b>1278-02</b>	14-15
3M NYLON INSULATED BLOCK SPADE WIRE TERMINAL	<b>JAR</b>	<b>1278-03</b>	14-15
3M NYLON INSULATED FLANGE SPADE WIRE TERMINAL	<b>JBR</b>	<b>1278-04</b>	14-15
3M NYLON INSULATED FLANGE BLOCK SPADE WIRE TERMINAL	<b>JCR</b>	<b>1278-05</b>	14-15
3M NYLON INSULATED FEMALE QUICK SLIDE WIRE TERMINAL	<b>JDR</b>	<b>1278-06</b>	14-16
3M NYLON INSULATED MALE QUICK SLIDE WIRE TERMINAL	<b>JBM</b>	<b>1278-07</b>	14-16
3M NYLON INSULATED CROSS LOK WIRE TERMINAL	<b>JFR</b>	<b>1278-09</b>	14-16
3M NYLON INSULATED MULTI-STACK WIRE TERMINAL	<b>JGR</b>	<b>1278-10</b>	14-16
3M NYLON INSULATED SNAP PLUG WIRE TERMINAL	<b>JHR</b>	<b>1278-11</b>	14-16
3M NYLON INSULATED BUTT CONNECTOR WIRE TERMINAL	<b>RXB</b>	<b>1278-12</b>	14-16
3M NYLON INSULATED GRIP BUTT CONNECTOR WIRE TERMINAL	<b>JJR</b>	<b>1278-13</b>	14-16
3M NYLON INSUL. GREASE FILLED BUTT CONNECTOR WIRE TERMINAL	<b>JJR</b>	<b>1278-13</b>	14-16
3M NYLON FULL INSULATED SNAP PLUG FEMALE RECEPTICAL	<b>SLB</b>	<b>1278-14</b>	14-16
3M NYLON FULL INSULATED FEMALE SLIDE TERMINAL	<b>SLB</b>	<b>1278-15</b>	14-16
3M NYLON FULL INSULATED MALE SLIDE TERMINAL	<b>SLB</b>	<b>1278-16</b>	14-16

(CONTINUED...)

# SECTION 14 PRODUCT INDEX

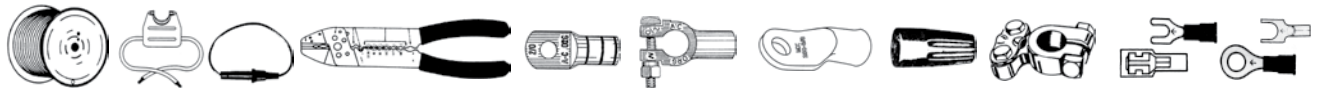

## ELECTRICAL (continued)

Line Description	Alpha	Line#	Page#
3M NYLON CLOSED END BUTT CONNECTOR TERMINAL	SLB	1278-17	14-17
NYLON HOOK WIRE TERMINAL	JZL	1278-18	14-17
INSULATED HEAT SEALING BUTT CONNECTOR TERMINAL	JUR	1278-19	14-17
INSULATED HEAT SEALING RING TERMINAL	JVR	1278-20	14-17
INSULATED HEAT SEALING SPADE TERMINAL	JWR	1278-21	14-17
INSULATED HEAT SEALING FEMALE QUICK SLIDE TERMINAL	JXR	1278-22	14-17
INSULATED HEAT SEALING MALE QUICK SLIDE TERMINAL	JYR	1278-23	14-17
INSULATED HEAT SEALING MALE & FEMALE PLUG TERMINAL	CEW	1278-24	14-17
INSULATED SOLDER LINK SEALING BUTT CONNECTOR TERMINAL	ARD	1278-30	14-17
INSULATED SOLDER LINK SEALING RING TERMINAL	ARE	1278-31	14-17
INSULATED SOLDER LINK SEALING SPADE TERMINAL	ARF	1278-32	14-18
INSULATED SOLDER LINK SEALING QUICK SLIDE TERMINAL	APL	1278-33	14-18
3M NYLON INSULATED PIN TERMINAL	AUG	1278-40	14-18
3M NYLON FULL INSULATED FEMALE TAB FLAG INTERMINAL	CEZ	1278-45	14-18
HI-TEMPERATURE RING TERMINAL	RUB	1279-00	14-18
HI-TEMPERATURE RING TERMINAL	RUB	1280-00	14-18
HI-TEMPERATURE BUTT CONNECTOR TERMINAL	SHB	1281-00	14-18
HI-TEMPERATURE SPADE TERMINAL	GCD	1282-00	14-18
HI-TEMPERATURE FEMALE QUICK SLIDE TERMINAL	GED	1284-00	14-18
HI-TEMPERATURE FEMALE QUICK SLIDE FLAG TERMINAL	GED	1285-00	14-18
HI-TEMPERATURE MALE QUICK SLIDE TERMINAL	GED	1286-00	14-18
HI-TEMPERATURE OPEN END QUICK SLIDE TERMINAL	GED	1288-00	14-19
SPECIALTY STYLE DOUBLE FEMALE SNAP .157 TERMINAL	SLB	1289-00	14-19
SPECIALTY STYLE DOUBLE FEMALE SNAP .176 TERMINAL	SLB	1291-00	14-19
SPECIALTY STYLE DOUBLE MALE-FEMALE 1/4 TAB ADPT TERMINAL	SLB	1292-00	14-19
SPECIALTY STYLE DOUBLE MALE INSULATED 1/4 TAB TERMINAL	SLB	1293-00	14-19
SPECIALTY STYLE DOUBLE MALE X SINGLE FEMALE TAB TERMINAL	SLB	1294-00	14-19
SPECIALTY STYLE PLAIN MULTI-STACK DISCONN TERMINAL	SLB	1303-00	14-19
SPECIALTY STYLE PLAIN FEMALE TAB QK/SLD FLAG TERMINAL	SLB	1306-00	14-19
SPECIALTY STYLE VINYL MALE SNAP PLUG X MALE 1/4 TAB DISCONNECT	SLB	1307-00	14-19
SPECIALTY STYLE VINYL TRAILER SOCKET PIN CONN TERMINAL	SLB	1309-00	14-19
SPECIALTY STYLE VINYL TRAILER SOCKET PIN CONN TERMINAL	SLB	1311-00	14-19
SPECIALTY STYLE PLAIN FEM QUICK SLIDE RIGHT ANGLE TERMINAL	SLB	1313-00	14-19
SPECIALTY STYLE PLAIN SPLIT TAB MALE SLIDE TERMINAL	SLB	1314-00	14-19
SPECIALTY STYLE TRAILER T-TAP INSULATED MALE PLUG TERMINAL	GBD	1325-00	14-19
SPECIALTY STYLE TRAILER T-TAP INSULATED FEM RECP TERMINAL	GBD	1326-00	14-20
AUTOMOTIVE CURRENT LAMP BULBS	JTF	1326-02	14-20
UNIVERSAL ELBOW BATTERY TERMINAL ENDS	SRB	1334-00	14-20
EMERGENCY O-GAUGE BATTERY TERMINAL ENDS	SRB	1335-00	14-20

(CONTINUED...)

# SECTION 14 PRODUCT INDEX



## ELECTRICAL (continued)

Line Description	Alpha	Line#	Page#
EMERGENCY O-GAUGE BATTERY TERMINAL ENDS	SRB	1336-00	14-20
MARINE TYPE BATTERY TERMINAL ENDS	SRB	1337-00	14-21
MILITARY TYPE BATTERY TERMINAL ENDS	SRB	1338-00	14-21
SIDE POST TERMINAL ADAPTER	SRB	1339-00	14-21
SPLIT BARREL BATTERY TERMINAL END	SRB	1340-00	14-21
SPLIT NEGATIVE BARREL BATTERY TERMINAL END	SRB	1341-00	14-21
SPLIT POSITIVE BARREL BATTERY TERMINAL END	SRB	1342-00	14-21
2/0 - 3/0 STRAIGHT NEGATIVE BATTERY TERMINAL END	SRB	1343-00	14-21
2/0 - 3/0 STRAIGHT POSITIVE BATTERY TERMINAL END	SRB	1344-00	14-21
UNIVERSAL STRAIGHT BATTERY TERMINAL	SRB	1345-00	14-21
UNIVERSAL STRAIGHT EMERGENCY BATTERY TERMINAL	SRB	1347-00	14-21
NEGATIVE BATTERY CRIMP TERMINAL	ZCB	1348-00	14-21
POSITIVE BATTERY CRIMP TERMINAL	ZCB	1349-00	14-22
UNIVERSAL BATTERY TERMINAL END	ZCB	1351-00	14-22
BATTERY CHARGING CLIPS	FND	1352-00	14-22
BATTERY POST ADAPTERS	FND	1353-00	14-22
BATTERY POST CLEANER	FND	1354-00	14-22
BATTERY POST SHIM CAP	FND	1355-00	14-22
BOOSTER CABLE & CHARGING CLIPS	FND	1356-00	14-22
BATTERY BOOSTER CABLES HEAVY DUTY	JYN	1356-01	14-22
PLAIN COPPER HEAVY DUTY CABLE LUGS	STB	1357-00	14-23
PRIMARY AUTOMOTIVE ELECTRIC WIRE 100FT	SVB	1358-00	14-23
PRIMARY AUTOMOTIVE ELECTRIC WIRE 1000FT	JNN	1358-01	14-24
MECHANIC'S WIRE 5#LB SPOOL	SVB	1358-02	14-24
JACKETED MULTI-CONDUCTOR PRIMARY WIRE 100FT	AMK	1358-03	14-24
BONDED MULTI-CONDUCTOR PRIMARY WIRE 100FT	BJL	1358-04	14-24
TINNED SINGLE CONDUCTOR PRIMARY WIRE 100FT	BPJ	1358-06	14-25
TRAILER LIGHT CABLE MULTI-CONDUCTOR	BJM	1358-10	14-25
COPPER INSULATED STARTER CABLE .375 O.D.	FPD	1360-00	14-25
COPPER INSULATED STARTER CABLE .450 O.D.	FPD	1361-00	14-25
COPPER INSULATED STARTER CABLE .500 O.D.	FPD	1362-00	14-25
COPPER INSULATED STARTER CABLE .530 O.D.	FPD	1363-00	14-25
COPPER INSULATED STARTER CABLE .590 O.D.	FPD	1364-00	14-25
COPPER INSULATED STARTER CABLE .650 O.D.	FPD	1365-00	14-25
SPLIT LOOM (POLY) FOR WIRE & CABLE	FRD	1366-00	14-26
ALKALINE INDUSTRIAL CELL BATTERIES	CDG	1366-10	14-26
UNIVERSAL TERMINAL CRIMPING TOOL	SMB	1367-00	14-26
TERMINAL LUG CRIMPING TOOLS	FCD	1368-00	14-26
COPPER CABLE HAND CUTTER	FCD	1368-01	14-26

(CONTINUED...)

# SECTION 14 PRODUCT INDEX



## ELECTRICAL (continued)

Line Description	Alpha	Line#	Page#
ELECTRICAL WIRE NUTS (3M)	<b>SPB</b>	<b>1369-00</b>	14-26
WING STYLE ELECTRICAL WIRE NUTS	<b>AUF</b>	<b>1369-01</b>	14-26
3M RUBBER SKIRTED WIRE NUTS	<b>CBR</b>	<b>1369-03</b>	14-26
IDEAL STYLE ELECTRICAL WIRE NUTS	<b>FFD</b>	<b>1370-00</b>	14-26
3M DIRECT BURY MOISTURE PROOF ELECTRICAL KITS	<b>SNB</b>	<b>1372-00</b>	14-27
3M SCOTCH LOCK WIRE TERMINALS	<b>SNB</b>	<b>1372-01</b>	14-27
AUTOMOTIVE GLASS FUSE HOLDERS	<b>ZDB</b>	<b>1373-00</b>	14-27
AUTOMOTIVE FUSES	<b>JJD</b>	<b>1374-00</b>	14-27
AUTOMOTIVE FUSE HOLDERS	<b>JJD</b>	<b>1374-03</b>	14-28
AUTOMOTIVE CIRCUIT BREAKES	<b>JJD</b>	<b>1374-06</b>	14-28



**CALL - 1 (800) 723-2826**

### STRAIGHT GREASE FITTING

Line: 1175-00



PART NUMBER	SIZE	QTY/BX	LIST PRICE
PXB205000L	1/8 IPT SELF TAP	50	
PXB5000L	1/8 IPT REG	50	
PXB5003L	1/8 IPT 1 1/4 LG	25	
PXB5007L	1/8 IPT 1 3/4 LG	25	
PXB5009L	1/8 IPT 2 5/8 LG	25	
PXB5505L	1/8 IPT FEMALE	25	
PXB5042L	1/4-28 SHORT	50	
PXB205010L	1/4-28 SELF TAP	50	
PXB5010L	1/4-28 REG	50	
PXB5013L	1/4-28 X 11/16 LG	50	
PXB5014L	1/4-28 X 15/16 LG	25	
PXB5050L	1/4 IPT REG	25	

### STRAIGHT DRIVE GREASE FITTING

Line: 1176-00



PART NUMBER	SIZE	QTY/BX	LIST PRICE
PXB5033L	3/16 DRIVE	50	
PXB700375	3/16 NO/CHECK DRIVE	50	
PXB5029L	1/4 DRIVE	50	
PXB5044L	1/4 LESS CHECK DRIVE	25	
PXB5030L	5/16 LESS CHECK DRIVE	50	
PXB5031L	5/16 DRIVE	50	
PXB5036L	3/8 DRIVE	25	

### 45° GREASE FITTING

Line: 1179-00



PART NUMBER	SIZE	QTY/BX	LIST PRICE
PYB5200L	1/8 IPT REG	25	
PYB211668	1/4 DRIVE	25	
PYB5210L	1/4-28 REG	25	
PYB5212L	1/4-28 LONG	25	

### 90° GREASE FITTING

Line: 1182-00



PART NUMBER	SIZE	QTY/BX	LIST PRICE
PZB5400L	1/8 IPT REG	25	
PZB5410L	1/4-28 REG	25	

### 30° GREASE FITTINGS

Line: 1184-00



PART NUMBER	SIZE	QTY/BX	LIST PRICE
RAB5100L	1/8 IPT REG	25	

### 65° GREASE FITTING

Line: 1187-00



PART NUMBER	SIZE	QTY/BX	LIST PRICE
RBB5350L	1/4 IPT REG	25	

### 65° GREASE FITTING

Line: 1188-00



PART NUMBER	SIZE	QTY/BX	LIST PRICE
RCB5300L	1/8 IPT REG	25	
RCB5308L	1/8 IPT 1 3/16	25	
RCB5311L	1/4-28	25	

### 65° DRIVE GREASE FITTING

Line: 1189-00



PART NUMBER	SIZE	QTY/BX	LIST PRICE
RCB5385L	3/16 DRV	25	
RCB5318L	1/4 DRV	25	

### STRAIGHT MALE BUTTON GREASE FITTING

Line: 1192-00



PART NUMBER	SIZE	QTY/BX	LIST PRICE
RDB5700L	1/8 IPT REG	25	
RDB5705L	1/4 IPT REG (#5706)	25	
RDB5710L	3/8 IPT REG	25	
RDB5715L	1/2 IPT REG	25	

### STRAIGHT METRIC GREASE FITTING

Line: 1194-00



PART NUMBER	SIZE	QTY/BX	LIST PRICE
FDD4379J	M6-1.0	25	
FDD4380J	M8-1.0	25	
FDD4381J	M10-1.0	25	

## 45° METRIC LUBRICATION FITTING

Line: 1195-00



PART NUMBER	SIZE	QTY/BX	LIST PRICE
FDD4382J	M6-1.0	25	
FDD4383J	M8-1.0	25	
FDD4384J	M10-1.0	25	

## 90° METRIC LUBRICATION FITTING

Line: 1196-00



PART NUMBER	SIZE	QTY/BX	LIST PRICE
FDD4385J	M6-1.0	25	
FDD4386J	M8-1.0	25	
FDD4387J	M10-1.0	25	

## ANGLE FITTING DRIVING TOOL

Line: 1198-00



PART NUMBER	SIZE	QTY/BX	LIST PRICE
REB11509L	11509	1	

## GREASE WHIP HOSE 1/8 IPT

Line: 1202-00



PART NUMBER	SIZE	QTY/BX	LIST PRICE
REB75912L	12X1/8MPT (#5812) N/SPRING	1	
REB75918L	18X1/8MPT (#5818) W/SPRING	1	

## GREASE GUN FILLER NIPPLE

Line: 1203-00



PART NUMBER	SIZE	QTY/BX	LIST PRICE
REB91108L	1/8 M.P.T.	1	

## MISC. LINCOLN ADAPTER FITTINGS AND TOOLS

Line: 1203-01

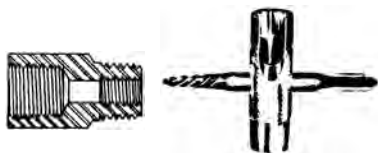

PART NUMBER	SIZE	QTY/BX	LIST PRICE
JKY10182	1/8 MPT X 1/8FPT ADAPTOR	5	
JKY10460L	1/8 X 7/16-27 B/HD ADAPTOR	1	
JKY90776	1/8 NPT EXTRACTOR/TAP TOOL	1	
JKY20024	1/4-28 X 1/8NPSF ADAPTOR	5	
JKY66953	1/4-28 EXTRACTOR/TAP TOOL	1	

## HAND PUMP PORTABLE GREASE GUN

Line: 1204-00



PART NUMBER	SIZE	QTY/BX	LIST PRICE
REB1132	PISTOL GRIP 16 OZ	1	
REB410R	16 OZ #1142 (LEVER)	1	

## HEAVY DUTY GREASE COUPLER

Line: 1206-00



PART NUMBER	SIZE	QTY/BX	LIST PRICE
REB5845L	#54	1	

## STANDARD/LARGE BUTTON FITTING GREASE COUPLER

Line: 1209-00



PART NUMBER	SIZE	QTY/BX	LIST PRICE
REB80933L	7/8 BUTTON (LARGE)	1	
REB81458L	5/8 BUTTON STANDARD	1	

## STRAIGHT FITTING DRIVING TOOL

Line: 1210-00



PART NUMBER	SIZE	QTY/BX	LIST PRICE
REB11485L	11485	1	

## THIN NOSE GREASE COUPLER

Line: 1212-00



PART NUMBER	SIZE	QTY/BX	LIST PRICE
REB52PJAW	52P REPLACEMENT COUPLER JAWS	1	
REB5852L	#52P COUPLER	1	

## 30° GREASE ADAPTER TUBES

Line: 1214-00



PART NUMBER	SIZE	QTY/BX	LIST PRICE
REB10R	1/8 MPT X 12 LONG	1	
REB6R	1/8 MPT X 5 3/8 LONG	1	

## SWIVEL GREASE COUPLER

HIGH PRESSURE

Line: 1216-00



PART NUMBER	SIZE	QTY/BX	LIST PRICE
GFD5848L	HYD 360° SWIVEL COUPLER	1	
GFD81387L	1/2-27 X 1/4 MPT	1	

### STRAIGHT VENTED GREASE FITTING



Line: 1222-00

PART NUMBER	SIZE	QTY/BX	LIST PRICE
GFD5099L	1/8 MPT	25	

### PRESSURE RELIEF VALVE

1/8 PIPE THREAD

Line: 1226-00

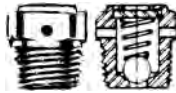

PART NUMBER	SIZE	QTY/BX	LIST PRICE
GFD5677L	1-5 PSI	10	
GFD5678L	7-15 PSI	10	
GFD5679L	15-25 PSI	25	
GFD5680L	45-80 PSI	25	

### 45° STREET ELBOW ADAPTER

Line: 1227-00



PART NUMBER	SIZE	QTY/BX	LIST PRICE
GFD20028L	1/8 MPT X 1/8 FPT	10	

### 90° STREET ELBOW ADAPTER

Line: 1233-00



PART NUMBER	SIZE	QTY/BX	LIST PRICE
GFD20029L	1/8 MPT X 1/8 FPT	10	
GFD20026L	1/4-28ML X 1/8 FPT	10	

### 3M VINYL RING

WIRE TERMINAL

Line: 1242-00



PART NUMBER	SIZE	QTY/BX	LIST PRICE
RFB114SP	W 22 X 45	50	
RFB116SP	W 22 X 65	50	
RFB116P	W 22 X 6	50	
RFB118SP	W 22 X 85	50	
RFB118P	W 22 X 8	50	
RFB1110P	W 22 X 10	50	
RFB1114P	W 22 X 1/4	50	
RFB1156SP	W 22 X 5/16S	50	
RFB1138P	W 22 X 3/8	50	
RFB124P	W 16 X 4	50	
RFB126SP	W 16 X 65	50	
RFB126P	W 16 X 6	50	
RFB126PC	W 16 X 6	100	
RFB128SP	W 16 X 85	50	
RFB128P	W 16 X 8	50	

(continued...)

### 3M VINYL RING (continued)

WIRE TERMINAL

Line: 1242-00



PART NUMBER	SIZE	QTY/BX	LIST PRICE
RFB1210P	W 16 X 10	50	
RFB1214SP	W 16 X 1/4S	50	
RFB1214P	W 16 X 1/4	50	
RFB1256SP	W 16 X 5/16S	50	
RFB1256P	W 16 X 5/16	50	
RFB1238P	W 16 X 3/8	50	
RFB136SP	W 12 X 65	50	
RFB136P	W 12 X 6	50	
RFB138SP	W 12 X 85	50	
RFB138P	W 12 X 8	50	
RFB1310P	W 12 X 10	50	
RFB1314SP	W 12 X 1/4S	50	
RFB1314P	W 12 X 1/4	50	
RFB1356SP	W 12 X 5/16S	50	
RFB1356P	W 12 X 5/16	50	
RFB1338SP	W 12 X 3/8S	50	
RFB1338P	W 12 X 3/8	50	
RFB13716P	W 12 X 7/16	50	
RFB13500P	W 12 X 1/2	25	
RFB1438WP	W 8 X 3/8	250	
RFB1458WP	W 8 X 5/8	10	
RFB15716SWP	W 6 X 7/16S	25	
RFB1558WP	W 6 X 5/8	10	
RFB1575WP	W 6 X 3/4	10	
RFB1610WP	W 4 X 10	10	
RFB1656WP	W 4 X 5/16	10	
RFB16716SWP	W 4 X 7/16S	10	
RFB16500SWP	W 4 X 1/2S	10	
RFB0204PVC	2 GA X 1/4 PVC INSL	5	
RFB1006PVC	1/0 X 3/8 PVC INSL	5	



CALL - 1 (800) 723-2826

CALL: (800) 723-2826

### 3M VINYL SPADE

WIRE TERMINAL

Line: 1243-00



PART NUMBER	SIZE	QTY/BX	LIST PRICE
RGB316P	W 22 X 6-4	50	
RGB318P	W 22 X 8	50	
RGB3110P	W 22 X 10	50	
RGB2214X	W 22 X 1/4	50	
RGB326P	W 16 X 6-4	50	
RGB328P	W 16 X 8	50	
RGB3210P	W 16 X 10	50	
RGB336P	W 12 X 6-4	50	
RGB338P	W 12 X 8	50	
RGB3310P	W 12 X 10	50	

### 3M VINYL FLANGE SPADE

WIRE TERMINAL

Line: 1244-00

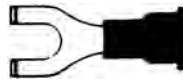

PART NUMBER	SIZE	QTY/BX	LIST PRICE
RHB216P	W 22 X 6-4	50	
RHB218P	W 22 X 8	50	
RHB2110P	W 22 X 10	50	
RHB226P	W 16 X 6-4	50	
RHB228P	W 16 X 8	50	
RHB2210P	W 16 X 10	50	
RHB236P	W 12 X 6-4	50	
RHB238P	W 12 X 8	50	
RHB2310P	W 12 X 10	50	

### 3M VINYL HOOK

WIRE TERMINAL

Line: 1245-00



PART NUMBER	SIZE	QTY/BX	LIST PRICE
RJB216P	W 22 X 6-4	50	
RJB218P	W 22 X 8	50	
RJB2110P	W 22 X 10	50	
RJB226P	W 16 X 6-4	50	
RJB228P	W 16 X 8	50	
RJB2210P	W 16 X 10	50	
RJB236P	W 12 X 6-4	50	
RJB238P	W 12 X 8	50	
RJB2310P	W 12 X 10	50	

### VINYL BLOCK SPADE

WIRE TERMINAL

Line: 1246-00



PART NUMBER	SIZE	QTY/BX	LIST PRICE
RKBS316SP	W 22 X 6S-4	50	
RKBS316P	W 22 X 6-4	50	
RKBS318P	W 22 X 8	50	
RKBS3110P	W 22 X 10	50	
RKBS324SP	W 16 X 4	50	
RKBS326SP	W 16 X 6S-4	50	
RKBS326P	W 16 X 6-4	50	
RKBS328P	W 16 X 8	50	
RKBS3210P	W 16 X 10	50	
RKBS336P	W 12 X 6	50	
RKBS338P	W 12 X 8	50	
RKBS3310P	W 12 X 10	50	

### VINYL FLANGE BLOCK SPADE

WIRE TERMINAL

Line: 1247-00



PART NUMBER	SIZE	QTY/BX	LIST PRICE
RLBS216P	W 22 X 6-4	50	
RLBS216SP	W 22 X 6S	50	
RLBS218P	W 22 X 8	50	
RLBS2110P	W 22 X 10	50	
RLBS226P	W 16 X 6-4	50	
RLBS228P	W 16 X 8	50	
RLBS2210P	W 16 X 10	50	
RLBS236P	W 12 X 6	50	
RLBS238P	W 12 X 8	50	
RLBS2310P	W 12 X 10	50	

### VINYL 3/WAY CONNECTOR

WIRE TERMINAL

Line: 1248-00



PART NUMBER	SIZE	QTY/BX	LIST PRICE
RVB322P	W 22-18	25	
RVB316P	W 16-14	25	
RVB312P	W 12-10	25	

### VINYL 4/WAY CONNECTOR

WIRE TERMINAL

Line: 1249-00



PART NUMBER	SIZE	QTY/BX	LIST PRICE
RWB422P	W 22-18	25	
RWB416P	W 16-14	25	
RWB412P	W 12-10	25	



### VINYL FEMALE QUICK SLIDE

WIRE TERMINAL

Line: 1250-00



PART NUMBER	SIZE	QTY/BX	LIST PRICE
RYB711F110PM	W 22 X 1/8 TAB	50	
RYB711F187P	W 22 X 3/16 TAB	50	
RYB711F250P	W 22 X 1/4 TAB	50	
RYB722F187P	W 16 X 3/16 TAB	50	
RYB722F250P	W 16 X 1/4 TAB	50	
RYB733F250P	W 12 X 1/4 TAB	50	
RYB73F37550P	W 12 X 3/8 TAB	50	
RYB72F11030F	W 16 X 1/8 TAB	50	

### VINYL MALE QUICK SLIDE

WIRE TERMINAL

Line: 1251-00



PART NUMBER	SIZE	QTY/BX	LIST PRICE
RZB71M18720P	W 22 X 3/16 TAB	50	
RZB71M25030P	W 22 X 1/4 TAB	50	
RZB72M18716P	W 16 X 3/16 TAB	50	
RZB72M25030P	W 16 X 1/4 TAB	50	
RZB73M25030P	W 12 X 1/4 TAB	50	

### VINYL CROSS LOCK

WIRE TERMINAL

Line: 1253-00



PART NUMBER	SIZE	QTY/BX	LIST PRICE
SBB761P	W 22 X 1/4 TAB	50	
SBB762P	W 16 X 1/4 TAB	50	

### VINYL SNAP PLUG

WIRE TERMINAL

Line: 1254-00



PART NUMBER	SIZE	QTY/BX	LIST PRICE
SKB81M157P	W 22 X .156	50	
SKB81M176P	W 22 X .180	50	
SKB82M157P	W 16 X .156	50	
SKB82M176P	W 16 X .180	50	
SKB83M157P	W 12 X .156	50	

### VINYL BUTT CONNECTOR

WIRE TERMINAL

Line: 1256-00



PART NUMBER	SIZE	QTY/BX	LIST PRICE
RXB61P	W 22-18	50	
RXB62P	W 16-14	50	
RXB63P	W 12-10	50	
RXB64WP	W 8	10	
RXB65WP	W 6	10	
RXB66WP	W 4	10	
RXB6261P	W16 TO W22 STEPDOWN	25	
RXB6362P	W12 TO W16 STEPDOWN	25	
RXB6463P	W12 TO W8 STEPDOWN	25	

### VINYL MULTI-STUD RING

WIRE TERMINAL

Line: 1258-00



PART NUMBER	SIZE	QTY/BX	LIST PRICE
FKD1126P	W22-2-4-6	50	
FKD11610P	W22-6-8-10	50	
FKD1226P	W16-2-4-6	50	
FKD12610P	W16-6-8-10	50	
FKD13610P	W12-6-8-10	50	

### VINYL SNAP SPADE

WIRE TERMINAL

Line: 1259-00



PART NUMBER	SIZE	QTY/BX	LIST PRICE
FLDSS314P	W22-4	50	
FLDSS316P	W22-6	50	
FLDSS318P	W22-8	50	
FLDSS3110P	W22-10	50	
FLDSS326P	W16-6	50	
FLDSS328P	W16-8	50	
FLDSS3210P	W16-10	50	
FLDSS3214P	W16-1/4	50	
FLDSS336P	W12-6	50	
FLDSS338P	W12-8	50	
FLDSS3310P	W12-10	50	
FLDSS3314P	W12-1/4	50	

## PLAIN RING

WIRE TERMINAL

Line: 1260-00



PART NUMBER	SIZE	QTY/BX	LIST PRICE
RMB114S	W22 X 4 S	50	
RMB114X	W22 X 4	50	
RMB116S	W22 X 6 S	50	
RMB116	W22 X 6	50	
RMB118S	W22 X 8 S	50	
RMB118	W22 X 8	50	
RMB1110	W22 X 10	50	
RMB1114S	W22 X 1/4 S	50	
RMB1114	W22 X 1/4	50	
RMB1156	W22 X 5/16	50	
RMB1138	W22 X 3/8	50	
RMB124S	W16 X 4 S	50	
RMB126S	W16 X 6 S	50	
RMB126	W16 X 6	50	
RMB126C	W16 X 6	100	
RMB128S	W16 X 8 S	50	
RMB128	W16 X 8	50	
RMB1210	W16 X 10	50	
RMB1214S	W16 X 1/4 S	50	
RMB1214	W16 X 1/4	50	
RMB1256S	W16 X 5/16 S	50	
RMB1256	W16 X 5/16	50	
RMB1238	W16 X 3/8	50	
RMB136S	W12 X 6 S	50	
RMB136	W12 X 6	50	
RMB138S	W12 X 8 S	50	
RMB138	W12 X 8	50	
RMB1310	W12 X 10	50	
RMB1314S	W12 X 1/4 S	50	
RMB1314	W12 X 1/4	50	
RMB1356S	W12 X 5/16 S	50	
RMB1356	W12 X 5/16	50	
RMB1338S	W12 X 3/8 S	50	
RMB1338	W12 X 3/8	50	
RMB13716	W12 X 7/16	50	
RMB13500	W12 X 1/2	50	
RMB1410SW	W8 X 10	50	
RMB1414SW	W8 X 1/4	25	
RMB1456W	W8 X 5/16	25	
RMB1438W	W8 X 3/8	25	
RMB14716SW	W8 X 7/16	25	
RMB14500SW	W8 X 1/2	10	
RMB1510SW	W6 X 10	50	

(continued...)

## PLAIN RING (continued)

WIRE TERMINAL

Line: 1260-00



PART NUMBER	SIZE	QTY/BX	LIST PRICE
RMB1514SW	W6 X 1/4	25	
RMB1556W	W6 X 5/16	25	
RMB1538W	W6 X 3/8	25	
RMB15716SW	W6 X 7/16S	25	
RMB15500SW	W6 X 1/2S	10	
RMB15500W	W6 X 1/2	10	
RMB1558W	W6 X 5/8	25	
RMB1610W	W4 X 10	25	
RMB1614W	W4 X 1/4	25	
RMB1656W	W4 X 5/16	25	
RMB1638W	W4 X 3/8	25	
RMB16716SW	W4 X 7/16	10	
RMB16500SW	W4 X 1/2S	10	
RMB16500W	W4 X 1/2S	10	

## PLAIN SPADE

WIRE TERMINAL

Line: 1261-00



PART NUMBER	SIZE	QTY/BX	LIST PRICE
RNB314X	W22 X 4	50	
RNB316	W22 X 6-4	50	
RNB318	W22 X 8	50	
RNB3110	W22 X 10	50	
RNB326	W16 X 6-4	50	
RNB328	W16 X 8	50	
RNB3210	W16 X 10	50	
RNB336	W12 X 6-4	50	
RNB338	W12 X 8	50	
RNB3310	W12 X 10	50	

## PLAIN HOOK

WIRE TERMINAL

Line: 1262-00



PART NUMBER	SIZE	QTY/BX	LIST PRICE
RPB416	W22 X 6-4	50	
RPB418	W22 X 8	50	
RPB4110	W22 X 10	50	
RPB426	W16 X 6-4	50	
RPB428	W16 X 8	50	
RPB4210	W16 X 10	50	
RPB438	W12 X 8	50	
RPB4310	W12 X 10	50	

**PLAIN FLANGE SPADE**

WIRE TERMINAL

Line: 1263-00

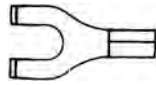

PART NUMBER	SIZE	QTY/BX	LIST PRICE
RRB216	W22 X 6-4	50	
RRB218	W22 X 8	50	
RRB2110	W22 X 10	50	
RRB226	W16 X 6-4	50	
RRB228	W16 X 8	50	
RRB2310	W12 X 10	50	

**PLAIN RING FLAG**

WIRE TERMINAL

Line: 1264-00



PART NUMBER	SIZE	QTY/BX	LIST PRICE
RSB516	W22 X 6-4	50	
RSB518	W22 X 8	50	
RSB5110	W22 X 10	50	
RSB528	W16 X 8	50	
RSB5210	W16 X 10	50	
RSB5310	W12 X 10	50	

**PLAIN SPADE FLAG**

WIRE TERMINAL

Line: 1265-00



PART NUMBER	SIZE	QTY/BX	LIST PRICE
RTBFS518	W22 X 8	50	
RTBFS5110	W22 X 10	50	
RTBFS526	W16 X 6-4	50	
RTBFS528	W16 X 8	50	
RTBFS5210	W16 X 10	50	
RTBFS5310	W12 X 10	50	

**BUTT CONNECTOR**

TINNED PLATED COPPER

Line: 1267-00



PART NUMBER	SIZE	QTY/BX	LIST PRICE
SDB60	W24-26	50	
SDB61	W22-18	50	
SDB62	W16-14	50	
SDB63	W12-10	50	
SDB64W	W8	10	
SDB65W	W6	10	
SDB66W	W4	10	
SDB2001-25	#2 AWG	10	
SDB1001-25	#1 AWG	10	
SDB10001-25	1/0 AWG	10	
SDB20001-25	2/0 AWG	10	
SDB30001-25	3/0 AWG	5	
SDB40001-25	4/0 AWG	5	

**PLAIN FEMALE QUICK SLIDE**

WIRE TERMINAL

Line: 1268-00



PART NUMBER	SIZE	QTY/BX	LIST PRICE
SEB70F11030	W26 X 1/8 TAB	50	
SEB711F18716	W22 X 3/16 TAB	50	
SEB711F25030	W22 X 1/4 TAB	50	
SEB72F11030	W16 X 1/8 TAB	50	
SEB722F18716	W16 X 3/16 TAB	50	
SEB722F25030	W16 X 1/4 TAB	50	
SEB733F25030	W12 X 1/4 TAB	50	
SEB73F37550	W12 X 3/8	50	

**PLAIN MALE QUICK SLIDE**

WIRE TERMINAL

Line: 1269-00



PART NUMBER	SIZE	QTY/BX	LIST PRICE
SFB71M18716	W22 X 3/16 TAB	50	
SFB2214MS	W22 X 1/4 TAB	50	
SFB72M18716	W16 X 3/16 TAB	50	
SFB72M25030	W16 X 1/4 TAB	50	
SFB73M25030	W12 X 1/4 TAB	50	

**PLAIN MALE QUICK SLIDE**

WIRE TERMINAL

Line: 1271-00



PART NUMBER	SIZE	QTY/BX	LIST PRICE
SJB81M157	W22 X .156	50	
SJB81M176	W22 X .180	50	
SJB82M157	W16 X .156	50	
SJB82M176	W16 X .176	50	
SJB83M157	W12 X .156	50	

**PLAIN MULTI-STUD RING**

WIRE TERMINAL

Line: 1272-00

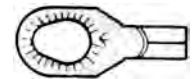

PART NUMBER	SIZE	QTY/BX	LIST PRICE
FSD12610	16 X 6-8-10	50	
FSD13610	12 X 6-8-10	50	



**CALL - 1 (800) 723-2826**



**CALL: (800) 723-2826**

# HEAVY DUTY RING CABLE LUGS

TINNED COPPER

Line: 1273-00



PART NUMBER	SIZE	QTY/BX	LIST PRICE
SVB1801SWP	AWG #8 X 1/4	10	
SVB1802SWP	AWG #8 X 5/16	10	
SVB1803SWP	AWG #8 X 3/8	10	
SVB850360	AWG #8 X 1/2	5	
SVB1811SWP	AWG #6 X 1/4	10	
SVB1812SWP	AWG #6 X 5/16	10	
SVB1813SWP	AWG #6 X 3/8	10	
SVB1814SWP	AWG #6 X 1/2	10	
SVB1821SWP	AWG #4 X 1/4	10	
SVB1822SWP	AWG #4 X 5/16	10	
SVB1823SWP	AWG #4 X 3/8	10	
SVB1824SWP	AWG #4 X 1/2	10	
SVB0204	AWG #2 X 1/4	10	
SVB0205	AWG #2 X 5/16	10	
SVB0206	AWG #2 X 3/8	10	
SVB0208	AWG #2 X 1/2	10	
SVB1831SWP	AWG #1 X 1/4	10	
SVB6401-005E	AWG #1 X 5/16	5	
SVB6401-005F	AWG #1 X 3/8	5	
SVB6401-005H	AWG #1 X 1/2	5	
SVB1004	AWG 1/0 X 1/4	5	
SVB1005	AWG 1/0 X 5/16	5	
SVB1006	AWG 1/0 X 3/8	5	
SVB1008	AWG 1/0 X 1/2	5	
SVB1010X	AWG 1/0 X 5/8	5	
SVB2004	AWG 2/0 X 1/4	5	
SVB2005	AWG 2/0 X 5/16	5	
SVB2006	AWG 2/0 X 3/8	5	
SVB2008	AWG 2/0 X 1/2	5	
SVB2010	AWG 2/0 X 5/8	5	
SVB2012	AWG 2/0 X 3/4	5	
SVB3004	AWG 3/0 X 1/4	5	
SVB3005	AWG 3/0 X 5/16	5	
SVB3006	AWG 3/0 X 3/8	5	
SVB3008	AWG 3/0 X 1/2	5	
SVB3010	AWG 3/0 X 5/8	5	
SVB3012	AWG 3/0 X 3/4	5	
SVB4005	AWG 4/0 X 5/16	5	
SVB4006	AWG 4/0 X 3/8	5	
SVB4008	AWG 4/0 X 1/2	5	
SVB4010	AWG 4/0 X 5/8	5	
SVB4012	AWG 4/0 X 3/4	5	

# LUG TERMINALS COLOR CODED

COPPER TINNED

Line: 1273-01

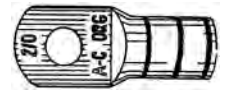

PART NUMBER	SIZE	QTY/BX	LIST PRICE
SVBC1800HD	AWG #8 X #10 RING RED	5	
SVB6408-005D	AWG #8 X 1/4 RED	5	
SVB6408-005E	AWG #8 X 5/16 RED	5	
SVB6408-005F	AWG #8 X 3/8 RED	5	
SVB6406-005D	AWG #6 X 1/4 BLUE	5	
SVB6406-005E	AWG #6 X 5/16 BLUE	5	
SVB6406-005F	AWG #6 X 3/8 BLUE	5	
SVBC1814HD	AWG #6 X 1/2 BLUE	5	
SVB6404-005D	AWG #4 X 1/4 GREY	5	
SVB6404-005E	AWG #4 X 5/16 GREY	5	
SVB6404-005F	AWG #4 X 3/8 GREY	5	
SVBC1824HD	AWG #4 X 1/2 GREY	5	
SVBC1831HD	AWG #1-2 X 1/4 PINK	5	
SVBC1832HD	AWG #1-2 X 5/16 PINK	5	
SVBC1833HD	AWG #1-2 X 3/8 PINK	5	
SVBC1834HD	AWG #1-2 X 1/2 PINK	5	
SVBC1851HD	AWG 1/0 X 1/4 BLACK	5	
SVBC1852HD	AWG 1/0 X 5/16 BLACK	5	
SVB6410-005F	AWG 1/0 X 3/8 BLACK	5	
SVB6410-005H	AWG 1/0 X 1/2 BLACK	5	
SVBC1862HD	AWG 2/0 X 5/16 ORANGE	5	
SVB6420-005F	AWG 2/0 X 3/8 ORANGE	5	
SVB6420-005H	AWG 2/0 X 1/2 ORANGE	5	
SVB6430-005F	AWG 3/0 X 3/8 PURPLE	5	
SVB6430-005H	AWG 3/0 X 1/2 PURPLE	5	
SVB6440-005F	AWG 4/0 X 3/8 YELLOW	5	
SVB6440-005H	AWG 4/0 X 1/2 YELLOW	5	

# PLAIN BLOCK SPADE

WIRE TERMINAL

Line: 1274-00



PART NUMBER	SIZE	QTY/BX	LIST PRICE
FVDBS316S	W22 X 6S	50	
FVDBS316	W22 X 6	50	
FVDBS318	W22 X 8	50	
FVDBS3110	W22 X 10	50	
FVDBS326S	W16 X 6 S	50	
FVDBS326	W16 X 6	50	
FVDBS328	W16 X 8	50	
FVDBS3210	W16 X 10	50	
FVDBS336	W12 X 6	50	
FVDBS338	W12 X 8	50	
FVDBS3310	W12 X 10	50	

### PLAIN FLANGE BLOCK SPADE

WIRE TERMINAL

Line: 1276-00

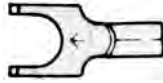

PART NUMBER	SIZE	QTY/BX	LIST PRICE
FWDBS216	W22 X 6-4	50	
FWDBS216S	W22 X 6S	50	
FWDBS218	W22 X 8	50	
FWDBS2110	W22 X 10	50	
FWDBS226	W16 X 6-4	50	
FWDBS226S	W16 X 6	50	
FWDBS228	W16 X 8	50	
FWDBS2210	W16 X 10	50	
FWDBS236P	W12 X 6	50	
FWDBS238P	W12 X 8	50	
FWDBS2310	W12 X 10	50	

### PLAIN SNAP SPADE

WIRE TERMINAL

Line: 1277-00

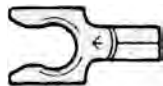

PART NUMBER	SIZE	QTY/BX	LIST PRICE
FXDSS316	W22 X 6	50	
FXDSS318	W22 X 8	50	
FXDSS3110	W22 X 10	50	
FXDSS324	W16 X 4	50	
FXDSS326	W16 X 6	50	
FXDSS328	W16 X 8	50	
FXDSS3210	W16 X 10	50	
FXDSS3214	W16 X 1/4	50	
FXDSS3310	W12 X 10	50	
FXDSS3314	W12 X 1/4	50	

### PLAIN CROSS LOCK DISCONNECT

WIRE TERMINAL

Line: 1278-00



PART NUMBER	SIZE	QTY/BX	LIST PRICE
FYD761	W22 X 1/4	25	
FYD762	W16 X 1/4	25	
FYD763	W12 X 1/4	25	

### NYLON RING

WIRE TERMINAL

Line: 1278-01



PART NUMBER	SIZE	QTY/BX	LIST PRICE
JKL112SNB	W22 X 2 SML	50	
JKL114SNB	W22 X 4 SML	50	
JKL116SNB	W22 X 6 SML	50	
JKL116NB	W22 X 6 REG	50	
JKLL116NB	W22 X 6 LRG	50	
JKL118SNB	W22 X 8 SML	50	
JKL118NB	W22 X 8 REG	50	
JKLL118NB	W22 X 8 LRG	50	
JKL1110NB	W22 X 10 REG	50	
JKLL1110NB	W22 X 10 LRG	50	
JKL1114SNB	W22 X 1/4 SML	50	
JKL1156NB	W22 X 5/16 SML	50	
JKL1138NB	W22 X 3/8 REG	50	
JKL122SNB	W16 X 2 SML	50	
JKL124SNB	W16 X 4 SML	50	
JKL126SNB	W16 X 6 SML	50	
JKL126NB	W16 X 6 REG	50	
JKLL126NB	W16 X 6 LRG	50	
JKL128SNB	W16 X 8 SML	50	
JKL128NB	W16 X 8 REG	50	
JKLL128NB	W16 X 8 LRG	50	
JKL1210NB	W16 X 10 REG	50	
JKLL1210NB	W16 X 10 LRG	50	
JKL1214SNB	W16 X 1/4 SML	50	
JKL1214NB	W16 X 1/4 REG	50	
JKL1256SNB	W16 X 5/16 SML	50	
JKL1256NB	W16 X 5/16 REG	50	
JKL1238NB	W16 X 3/8 REG	50	
JKL134SNB	W12 X 4 SML	50	
JKL136SNB	W12 X 6 SML	50	
JKL136NB	W12 X 6 REG	50	
JKL138SNB	W12 X 8 SML	50	
JKL138NB	W12 X 8 REG	50	
JKL1310NB	W12 X 10 REG	50	
JKL1314SNB	W12 X 1/4 SML	50	
JKL1314NB	W12 X 1/4 REG	50	
JKL1356SNB	W12 X 5/16 SML	50	
JKL1356NB	W12 X 5/16 REG	50	
JKL1338SNB	W12 X 3/8 SML	50	
JKL1338NB	W12 X 3/8 REG	50	
JKL13716NB	W12 X 7/16 REG	50	
JKL13500NB	W12 X 1/2 REG	50	
JKL1410SWN	W8 X 10S	25	

(continued...)

**NYLON RING** *(continued)*

WIRE TERMINAL

Line: 1278-01



PART NUMBER	SIZE	QTY/BX	LIST PRICE
JKL1414SWN	W8 X 1/4S	25	
JKL1456WN	W8 X 5/16	25	
JKL1438WN	W8 X 3/8	25	
JKL14716SWN	W8 X 7/16S	10	
JKL14500SWN	W8 X 1/2S	10	
JKL1458WN	W8 X 5/8	10	
JKL1475WN	W8 X 3/4	10	
JKL1510SWN	W6 X 10S	25	
JKL1514SWN	W6 X 1/4S	25	
JKL1556WN	W6 X 5/16	25	
JKL1538WN	W6 X 3/8	25	
JKL15716WN	W6 X 7/16	10	
JKL15500SWN	W6 X 1/2S	10	
JKL1558WN	W6 X 5/8	10	
JKL1610WN	W4 X 10	10	
JKL1614WN	W4 X 1/4	10	
JKL1656WN	W4 X 5/16	10	
JKL1638WN	W4 X 3/8	10	
JKL16716WN	W4 X 7/16	10	
JKL16500SWN	W4 X 1/2S	10	
JKL15500WX	W6 X 1/2	10	

**NYLON SPADE**

WIRE TERMINAL

Line: 1278-02



PART NUMBER	SIZE	QTY/BX	LIST PRICE
JZP316NB	W22 X 6 REG	50	
JZP318NB	W22 X 8 REG	50	
JZPL318NB	W22 X 8 LRG	50	
JZP3110NB	W22 X 10 REG	50	
JZP326NB	W16 X 6 REG	50	
JZP328NB	W16 X 8 REG	50	
JZP3210NB	W16 X 10 REG	50	
JZPL3210NB	W16 X 10 LRG	50	
JZP336NB	W12 X 6 REG	50	
JZP338NB	W12 X 8 REG	50	
JZP3310NB	W12 X 10 REG	50	

**NYLON BLOCK SPADE**

WIRE TERMINAL

Line: 1278-03



PART NUMBER	SIZE	QTY/BX	LIST PRICE
JARSS316NB	W22 X 6 SNAP-IN	50	
JARBS316SNB	W22 X 6 SML	50	
JARBS316NB	W22 X 6 REG	50	
JARSS318NB	W22 X 8 SNAP-IN	50	
JARBS318NB	W22 X 8 REG	50	
JARSS3110NB	W22 X 10 SNAP-IN	50	
JARBS3110NB	W22 X 10 REG	50	
JARSS326NB	W16 X 6 SNAP-IN	50	
JARBS326SNB	W16 X 6 SML	50	
JARBS326NB	W16 X 6 REG	50	
JARSS328NB	W16 X 8 SNAP-IN	50	
JARBS328NB	W16 X 8 REG	50	
JARSS3210NB	W16 X 10 SNAP-IN	50	
JARBS3210NB	W16 X 10 REG	50	
JARBS336NB	W12 X 6 REG	50	
JARBS338NB	W12 X 8 REG	50	
JARBS3310NB	W12 X 10 REG	50	

**NYLON FLANGE SPADE**

WIRE TERMINAL

Line: 1278-04



PART NUMBER	SIZE	QTY/BX	LIST PRICE
JBR218NB	W22 X 8	50	
JBR2110NB	W22 X 10	50	
JBR226NB	W16 X 6	50	
JBR228NB	W16 X 8	50	
JBR2210NB	W16 X 10	50	
JBR236NB	W12 X 6	50	
JBR238NB	W12 X 8	50	
JBR2310NB	W12 X 10	50	

**NYLON BLOCK FLANGE SPADE**

WIRE TERMINAL

Line: 1278-05



PART NUMBER	SIZE	QTY/BX	LIST PRICE
JCRBS216SNB	W22 X 6 SML	50	
JCRBS216NB	W22 X 6	50	
JCRBS218NB	W22 X 8	50	
JCRBS2110NB	W22 X 10	50	
JCRBS226SNB	W16 X 6 SML	50	
JCRBS226NB	W16 X 6	50	
JCRBS228NB	W16 X 8	50	
JCRBS2210NB	W16 X 10	50	
JCRBS236NB	W12 X 6	50	
JCRBS238NB	W12 X 8	50	
JCRBS2310NB	W12 X 10	50	

**NYLON FEMALE QUICK SLIDE**

WIRE TERMINAL

Line: 1278-06



PART NUMBER	SIZE	QTY/BX	LIST PRICE
JDR71F18720NB	W22 X 3/16	50	
JDR71F18732NB	W22 X 1/4	50	
JDR72F11020NB	W16 X 1/8	50	
JDR72F18720NB	W16 X 3/16	50	
JDR72F25032NB	W16 X 1/4	50	
JDR73F25032NB	W12 X 1/4	50	
JDR73F37550NB	W12 X 3/8	50	

**NYLON MALE QUICK SLIDE**

WIRE TERMINAL

Line: 1278-07



PART NUMBER	SIZE	QTY/BX	LIST PRICE
JBM71M187NBX	W22 X 3/16	50	
JBM71M25032NB	W22 X 1/4	50	
JBM72M18720NB	W16 X 3/16	50	
JBM72M25032NB	W16 X 1/4	50	
JBM73M25032NB	W12 X 1/4	50	

**NYLON CROSS LOK**

WIRE TERMINAL

Line: 1278-09



PART NUMBER	SIZE	QTY/BX	LIST PRICE
JFR761NB	W22 X 1/4	25	
JFR762NB	W16 X 1/4	25	
JFR763NB	W12 X 1/4	25	

**NYLON MULTI STACK**

WIRE TERMINAL

Line: 1278-10



PART NUMBER	SIZE	QTY/BX	LIST PRICE
JGR771250NB	W22 X 1/4	25	
JGR772250NB	W16 X 1/4	25	

**NYLON SNAP PLUG**

WIRE TERMINAL

Line: 1278-11



PART NUMBER	SIZE	QTY/BX	LIST PRICE
JHR81M156NB	W22 X .156	50	
JHR81M180NB	W22 X .180	50	
JHR82M156NB	W16 X .156	50	
JHR82M180NB	W16 X .180	50	
JHR83M156NB	W12 X .156	50	

**NYLON BUTT CONNECTOR**

WIRE TERMINAL

Line: 1278-12



PART NUMBER	SIZE	QTY/BX	LIST PRICE
RXB61SN	W22-18	50	
RXB62BELL	W16-14 (BUTTED)	1000	
RXB62SN	W14-16	50	
RXB63SN	W12-10	50	
RXB64WX	W8 WIRE	10	
RXB65WX	W6 WIRE	10	

**NYLON INSULATED GRIP BUTT CONNECTOR**

WIRE TERMINAL

Line: 1278-13

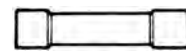

PART NUMBER	SIZE	QTY/BX	LIST PRICE
JJR61NBMR	W 22-18 GREASE FILLED	50	
JJR61NB	W 22-18	50	
JJR62NBMR	W 16-14 GREASE FILLED	50	
JJR62NB	W 16-14	50	
JJR63NBMR	W 12-10 GREASE FILLED	50	
JJR63NB	W 12-10	50	

**NYLON FULL INSULATED SNAP PLUG**

WIRE TERMINAL

Line: 1278-14



PART NUMBER	SIZE	QTY/BX	LIST PRICE
SLB81F157NL	W22 X .156	50	
SLB81F176NL	W22 X .180	50	
SLB82F157NL	W16 X .157	50	
SLB82F176NL	W16 X .180	50	

**NYLON FULL INSULATED FEMALE SLIDE**

WIRE TERMINAL

Line: 1278-15



PART NUMBER	SIZE	QTY/BX	LIST PRICE
SLB71F18720NL	W22 X 3/16	50	
SLB71F25030N	W22 X 1/4	50	
SLB72F18716N	W16 X 3/16	50	
SLB72F25030N	W16 X 1/4	50	
SLB73F25032NL	W12 X 1/4	50	

**NYLON FULL INSULATED FEMALE SLIDE**

WIRE TERMINAL

Line: 1278-16

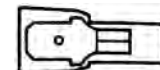

PART NUMBER	SIZE	QTY/BX	LIST PRICE
SLB71M18720NL	W22 X 3/16	50	
SLB71M25030N	W22 X 1/4	50	
SLB72M18716NL	W16 X 3/16	50	
SLB72M25030N	W16 X 1/4	50	
SLB5147J	W12 X 1/4	50	

CALL: (800) 723-2826

## NYLON CLOSED END BUTT CONNECTOR

WIRE TERMINAL

Line: 1278-17

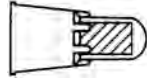

PART NUMBER	SIZE	QTY/BX	LIST PRICE
SLB722N	W22 WIRE 22/14	50	
SLB718N	W16 WIRE 18/10	50	

## NYLON HOOK

WIRE TERMINAL

Line: 1278-18



PART NUMBER	SIZE	QTY/BX	LIST PRICE
JZL428NB	W16 X 8	50	

## HEAT SEALING BUTT CONNECTOR

WIRE TERMINAL

Line: 1278-19



PART NUMBER	SIZE	QTY/BX	LIST PRICE
JUR2218HD	W22-18	25	
JUR1614HD	W16-14	25	
JUR1210HD	W12-10	25	
JUR1216HD	12 TO 16W STEPDOWN	25	
JUR08HD	#8 AWG	25	

## HEAT SEALING RING

WIRE TERMINAL

Line: 1278-20

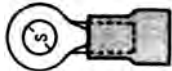

PART NUMBER	SIZE	QTY/BX	LIST PRICE
JVR1810R	W22-18 X 10	25	
JVR1814R	W22-18 X 1/4	25	
JVR1410R	W16-14 X 10	25	
JVR1414R	W16-14 X 1/4	25	
JVR1456R	W14-16 X 5/16	25	
JVR1438R	W14-16 X 3/8	25	
JVR1010R	W12-10 X 10	25	
JVR1014R	W12-10 X 1/4	25	
JVR1056R	W12-10 X 5/16	25	
JVR1038R	W12-10 X 3/8	25	
JVR1012R	W12-10 X 1/2	25	
JVR0810R	8 AWG X #10	25	
JVR0814R	8GA X 1/4	25	
JVR0838R	8GA X 3/8	25	
JVR0812R	8GA X 1/2	25	

## HEAT SEALING SPADE

WIRE TERMINAL

Line: 1278-21



PART NUMBER	SIZE	QTY/BX	LIST PRICE
JWR1810F	W22-18 X 10	25	
JWR1410F	W16-14 X 10	25	
JWR1010F	W12-10 X 10	25	

## HEAT SEALING FEMALE QUICK SLIDE

WIRE TERMINAL

Line: 1278-22

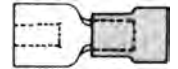

PART NUMBER	SIZE	QTY/BX	LIST PRICE
JXR1825FDF	W22-18 X 1/4	25	
JXR14250FDF	W16-14 X 1/4	25	
JXR1025FDF	W12-10 X 1/4	25	

## HEAT SEALING MALE QUICK SLIDE

WIRE TERMINAL

Line: 1278-23



PART NUMBER	SIZE	QTY/BX	LIST PRICE
JYR1825MDF	W22-18 X 1/4	25	
JYR14250MDF	W16-14 X 1/4	25	
JYR1025FDF	W12-10 X 1/4	25	

## HEAT SEALING MALE/FEMALE PLUG

WIRE TERMINAL

Line: 1278-24



PART NUMBER	SIZE	QTY/BX	LIST PRICE
CEW2218157MLE	W22/18 X .156 ML PLUG	25	
CEW2218157FEM	W22/18 X .157 FE PLUG	25	
CEW1614157MLE	W16/14 X .156 ML PLUG	25	
CEW1614157FEM	W16/14 X .157 FEM PLUG	25	

## SOLDER LINK SEALING BUTT CONNECTOR

WIRE TERMINAL

Line: 1278-30



PART NUMBER	SIZE	QTY/BX	LIST PRICE
ARDELA516	W18-22 X 1.25 RED	25	
ARDELA514	W14-16 X 1.625 BLUE	25	
ARDELA510	W10-12 X 1.75 YELLOW	25	

## SOLDER LINK SEALING RING

WIRE TERMINAL

Line: 1278-31



PART NUMBER	SIZE	QTY/BX	LIST PRICE
AREELA11606	W18-22 X #6 RED	25	
AREELA11608	W18-22 X #8 RED	25	
AREELA11610	W18-22 X #10 RED	25	
AREELA11614	W18-22 X 1/4 RED	25	
AREELA11408	W14-16 X #8 BLUE	25	
AREELA11410	W14-16 X #10 BLUE	25	
AREELA11414	W14-16 X 1/4 BLUE	25	
AREELA11438	W14-16 X 3/8 BLUE	25	
AREELA11010	W10-12 X #10 YELLOW	25	
AREELA11014	W10-12 X 1/4 YELLOW	25	
AREELA11038	W10-12 X 3/8 YELLOW	25	
AREELA11012	W10-12 X 1/2 YELLOW	25	



### SOLDER LINK SEALING SPADE

WIRE TERMINAL

Line: 1278-32



PART NUMBER	SIZE	QTY/BX	LIST PRICE
ARFELA21610	W18-22 X #10 RED	25	
ARFELA21410	W14-16 X #10 BLUE	25	
ARFELA21010	W10-12 X #10 YELLOW	25	

### SOLDER LINK QUICK SLIDE

WIRE TERMINAL

Line: 1278-33



PART NUMBER	SIZE	QTY/BX	LIST PRICE
APELEA618M	W18-20/1/4 MALE TAB RED	25	
APELEA618F	W18-20/1/4 FEMALE TAB RED	25	
APELEA614M	W16-14/1/4 MALE TAB BLUE	25	
APELEA614F	W16-14/1/4 FEMALE TAB BLUE	25	
APELEA610M	W12-10/1/4 MALE TAB YELLOW	25	
APELEA610F	W10-12/1/4 FEMALE TAB YELLOW	25	

### 3M NYLON INSULATED

PIN TERMINAL

Line: 1278-40



PART NUMBER	SIZE	QTY/BX	LIST PRICE
AUG81P47NB	W22-18 RED	100	
AUG82P47NB	W16-14 BLUE	100	
AUG83P55NB	W12-10 YELLOW	100	

### FEMALE TAB FLAG FULLY INSULATED

NYLON

Line: 1278-45



PART NUMBER	SIZE	QTY/BX	LIST PRICE
CEZ221804	W22/18 X 1/4 TAB RED	1000	
CEZ221804P	W22/18 X 1/4 TAB RED	50	
CEZ161404	W16/14 X 1/4 TAB BLUE	1000	
CEZ161404P	W16/14 X 1/4 TAB BLUE	50	
CEZ121004	W12/10 X 1/4 TAB YELLOW	1000	
CEZ121004P	W12/10 X 1/4 TAB YELLOW	50	

### HIGH TEMPERATURE RING

WIRE TERMINAL

Line: 1279-00



PART NUMBER	SIZE	QTY/BX	LIST PRICE
RUBHT1414S	W8 X 1/4	50	

### HIGH TEMPERATURE RING

WIRE TERMINAL

Line: 1280-00



PART NUMBER	SIZE	QTY/BX	LIST PRICE
RUBHT116S	W22 X 6	50	
RUBHT1110	W22 X 10	50	
RUBHT1114	W22 X 1/4	50	
RUBHT126S	W16 X 6	50	
RUBHT1210	W16 X 10	50	
RUBHT1214	W16 X 1/4	50	
RUBHT136	W12 X 6	50	
RUBHT1310	W12 X 10	50	
RUBHT1314	W12 X 1/4	50	
RUBHT1338	W12 X 3/8	50	

### HIGH TEMPERATURE BUTT CONNECTOR

WIRE TERMINAL

Line: 1281-00

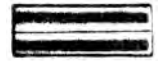

PART NUMBER	SIZE	QTY/BX	LIST PRICE
SHBHT61	W22	50	
SHBHT62	W16	50	
SHBHT63	W12	50	

### HIGH TEMPERATURE SPADE

WIRE TERMINAL

Line: 1282-00



PART NUMBER	SIZE	QTY/BX	LIST PRICE
GCDHT3110	W22 X 10	50	
GCDHT3210	W16 X 10	50	
GCDHT3310	W12 X 10	50	

### HIGH TEMPERATURE FEMALE QUICK SLIDE

WIRE TERMINAL

Line: 1284-00



PART NUMBER	SIZE	QTY/BX	LIST PRICE
GEDHT72F18720	W16 X 3/16	50	
GEDHT72F250	W16 X 1/4	50	

### HIGH TEMP FEMALE QUICK SLIDE FLAG

WIRE TERMINAL

Line: 1285-00



PART NUMBER	SIZE	QTY/BX	LIST PRICE
GEDHT752250	16 X 1/4	50	

### HIGH TEMPERATURE MALE QUICK SLIDE

WIRE TERMINAL

Line: 1286-00



PART NUMBER	SIZE	QTY/BX	LIST PRICE
GEDHT72M187	16 X 3/16	50	

## HIGH TEMP OPEN END MALE QUICK SLIDE

WIRE TERMINAL

Line: 1288-00



PART NUMBER	SIZE	QTY/BX	LIST PRICE
GEDHT720M250	16 X 1/4	50	

## DOUBLE FEMALE SNAP CONNECTOR

WIRE TERMINAL

Line: 1289-00



PART NUMBER	SIZE	QTY/BX	LIST PRICE
SLB8FF157PL	0.157	25	

## INSULATED DOUBLE FEMALE SNAP

PLUG RECEPTICLE

Line: 1291-00



PART NUMBER	SIZE	QTY/BX	LIST PRICE
SLB8FF176PL	0.176	25	

## DOUBLE MALE-FEMALE ADAPTER

1/4 TAB CONNECTOR

Line: 1292-00



PART NUMBER	SIZE	QTY/BX	LIST PRICE
SLB77250	1/4 TAB	25	

## DOUBLE MALE INSULATED

1/4 TAB CONNECTOR

Line: 1293-00

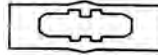

PART NUMBER	SIZE	QTY/BX	LIST PRICE
SLB7MM250PL	1/4 TAB	25	

## DOUBLE MALE TAB X SINGLE FEMALE TAB

WIRE TERMINAL

Line: 1294-00

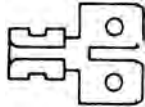

PART NUMBER	SIZE	QTY/BX	LIST PRICE
SLB7MMF250	1/4 TAB	50	

## PLAIN MULTI STACK DISCONNECT

WIRE TERMINAL

Line: 1303-00



PART NUMBER	SIZE	QTY/BX	LIST PRICE
SLB771250	W22 X 1/4	25	
SLB772250	W16 X 1/4	25	

## PLAIN FEMALE TAB QUICK SLIDE FLAG

WIRE TERMINAL

Line: 1306-00

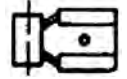

PART NUMBER	SIZE	QTY/BX	LIST PRICE
SLB751187	W22 X 3/16	50	
SLB752187	W16 X 3/16	50	
SLB754250	W12 X 1/4	50	

## MALE SNAP PLUG X MALE 1/4 TAB DISCONNECT

Line: 1307-00



PART NUMBER	SIZE	QTY/BX	LIST PRICE
SLB78MM	.157 X 1/4	50	

## VINYL MULTI-STACK DISCONNECT

WIRE TERMINAL

Line: 1309-00



PART NUMBER	SIZE	QTY/BX	LIST PRICE
SLB771250P	W22	25	
SLB772250P	W16	25	

## VINYL TRAILER SOCKET PIN CONNECTOR

WIRE TERMINAL

Line: 1311-00



PART NUMBER	SIZE	QTY/BX	LIST PRICE
SLB3069J	W16-14 82P-47-P PIN	100	
SLB3072J	W12-10 83p-55-P PIN	100	

## PLAIN FEMALE QUICK SLIDE RIGHT ANGLE

WIRE TERMINAL

Line: 1313-00



PART NUMBER	SIZE	QTY/BX	LIST PRICE
SLB751-250	W22-18 X 1/4 TAB	50	
SLB752250	W16-14 X 1/4 TAB	50	

## PLAIN 1/4 SPLIT TAB MALE SLIDE

WIRE TERMINAL

Line: 1314-00

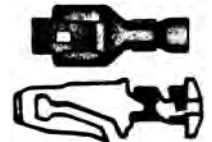

PART NUMBER	SIZE	QTY/BX	LIST PRICE
SLB3283	SPLIT TAB FE SLIDE	50	
SLB720MC250	710 SPLIT TAB MALE S	50	

## TRAILER T-TAP INSULATED MALE

PLUG CONNECTOR

Line: 1325-00



PART NUMBER	SIZE	QTY/BX	LIST PRICE
GBDT903	PLUG	50	

### TRAILER T-TAP INSULATED FEMALE

RECEPTICAL CONNECTOR

Line: 1326-00

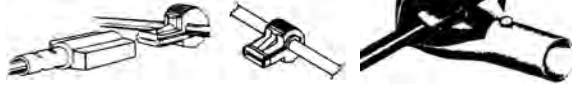

PART NUMBER	SIZE	QTY/BX	LIST PRICE
GBDT951	3M#951 22GA FEM TAB	25	
GBDT90	3M#952 16GA FEM TAB	25	
GBDT953	3M#953 12GA FEM TAB	25	

### AUTOMOTIVE CURRENT LAMP BULBS

Line: 1326-02



PART NUMBER	SIZE	QTY/BX	LIST PRICE
JTFMH3W55	H3 55WATT HALOGEN	10	
JTFM1073	M1073	10	
JTFM1816	1816	10	
JTFM1820	#1820 28V 0.1AMP	10	
JTFM1822	1822 MINIATURE BULB	10	
JTFM1891	M1891	10	
JTFM222	2.25V .25AMP	10	
JTFM4546	6 AUTO LAMPS/BOX	6	
JTFM1003	10 AUTO LAMPS PER BOX	10	
JTFM1004	10 AUTO LAMPS PER BOX	10	
JTFM1034	10 AUTO LAMPS/BOX	10	
JTFM1076	10 AUTO LAMPS PER BOX	10	
JTFM1141	10 AUTO LAMPS PER BOX	10	
JTFM1156	10 AUTO LAMPS PER BOX	10	
JTFM1156-NA	10 AUTO LAMPS	10	
JTFM1157	10 AUTO LAMPS PER BOX	10	
JTFM1157-NA	10 AUTO LAMPS PER BOX	10	
JTFM1204	10 AUTO LAMPS/BOX	10	
JTFM1251	10 AUTO LAMPS/BOX	10	
JTFM1662	10 AUTO LAMPS PER	10	
JTFM1666	10 AUTO LAMPS/BOX	10	
JTFM1683	10 AUTO LAMPS PER	10	
JTFM1893	10 AUTO LAMPS PER BOX	10	
JTFM1895	10 AUTO LAMPS PER BOX	10	
JTFM194	10 AUTO LAMPS PER BOX	10	
JTFM194-A	10 AUTO LAMPS PER BOX	10	
JTFM199	10 AUTO LAMPS PER BOX	10	
JTFM2057	10 AUTO LAMPS PER BOX	10	
JTFM2057-NA	10 AUTO LAMPS PER BOX	10	
JTFM211-2	10 AUTO LAMPS PER BOX	10	
JTFM2357	10 AUTO LAMPS PER BOX	10	
JTFM2357-NA	10 AUTO LAMPS PER BOX	10	
JTFM3057	10 AUTO LAMPS PER BOX	10	

(continued...)

### AUTOMOTIVE CURRENT LAMP BULBS

Line: 1326-02 (continued)



PART NUMBER	SIZE	QTY/BX	LIST PRICE
JTFM3057-NA	10 AUTO LAMPS PER BOX	10	
JTFM3156	10 AUTO LAMPS PER BOX	10	
JTFM3157	10 AUTO LAMPS PER BOX	10	
JTFM3157-NA	10 BULBS/BOX AMBER	10	
JTFM3357	10 AUTO LAMPS PER BOX	10	
JTFM37	10 AUTO LAMPS PER BOX	10	
JTFM53	10 AUTO LAMPS PER BOX	10	
JTFM57	10 AUTO LAMPS PER BOX	10	
JTFM623	10 AUTO LAMPS/BOX	10	
JTFM67	10 AUTO LAMPS PER BOX	10	
JTFM89	10 AUTO LAMPS PER BOX	10	
JTFM906	10 AUTO LAMPS PER BOX	10	
JTFM912	10 AUTO LAMPS PER	10	
JTFM916	10 AUTO LAMPS PER	10	
JTFM921	10 AUTO LAMPS PER BOX	10	
JTFM922	10 AUTO LAMPS PER BOX	10	
JTFM94	10 AUTO LAMPS	10	
JTFM97	10 AUTO LAMPS PER BOX	10	
JTFMKR1951	12V07AKJAPAN	10	

### UNIVERSAL ELBOW BATTERY

TERMINAL END

Line: 1334-00



PART NUMBER	SIZE	QTY/BX	LIST PRICE
SRB801KC	1 & 1/0	5	

### EMERGENCY O GAUGE

BATTERY TERMINAL END

Line: 1335-00



PART NUMBER	SIZE	QTY/BX	LIST PRICE
SRB5066	POSITIVE HVY DUTY BRASS	5	
SRB5067	NEGATIVE HVY DUTY BRASS	5	
SRB890N	NEGATIVE	5	
SRB890P	POSITIVE	5	
SRB890U	UNIVERSAL HD 1-4/0GA	5	
SRB891N	NEGATIVE ELBOW	5	
SRB891P	POSITIVE ELBOW	5	
SRB891U	UNIVERSAL ELBOW	5	

## EMERGENCY O GAUGE

BATTERY TERMINAL END

Line: 1336-00



PART NUMBER	SIZE	QTY/BX	LIST PRICE
SRB838KC	3/8 UNIV SIDE MOUNT	5	
SRB11083A	99001 side mnt bolt	1	

## MARINE TYPE

BATTERY TERMINAL END

Line: 1337-00



PART NUMBER	SIZE	QTY/BX	LIST PRICE
SRB862N	NEGATIVE	5	
SRB862P	POSITIVE	5	
SRB862U	UNIVERSAL	5	

## MILITARY TYPE

BATTERY TERMINAL END

Line: 1338-00



PART NUMBER	SIZE	QTY/BX	LIST PRICE
SRB870N	NEGATIVE	5	
SRB870P	POSITIVE	5	

## SIDE POST

BATTERY TERMINAL ADAPTER

Line: 1339-00



PART NUMBER	SIZE	QTY/BX	LIST PRICE
SRBSTN2	3/8 NEGATIVE	5	
SRBSTP	3/8 POSITIVE	5	

## SPLIT BARREL

BATTERY TERMINAL END

Line: 1340-00



PART NUMBER	SIZE	QTY/BX	LIST PRICE
SRB802KC	2 & 1	5	
SRB806KC	1/0 & 2/0	5	

## SPLIT NEGATIVE BARREL

BATTERY TERMINAL END

Line: 1341-00



PART NUMBER	SIZE	QTY/BX	LIST PRICE
SRB860NKC	2/0 & 3/0	5	

## SPLIT POSITIVE BARREL

BATTERY TERMINAL END

Line: 1342-00



PART NUMBER	SIZE	QTY/BX	LIST PRICE
SRB860PKC	2/0 & 3/0	5	

## 2/0-3/0 STRAIGHT NEGATIVE

BATTERY TERMINAL END

Line: 1343-00



PART NUMBER	SIZE	QTY/BX	LIST PRICE
SRB861NKC	2/0 & 3/0	5	

## 2/0-3/0 STRAIGHT POSITIVE

BATTERY TERMINAL END

Line: 1344-00



PART NUMBER	SIZE	QTY/BX	LIST PRICE
SRB861PKC	2/0 & 3/0	5	

## STRAIGHT UNIVERSAL

BATTERY TERMINAL END

Line: 1345-00



PART NUMBER	SIZE	QTY/BX	LIST PRICE
SRB803KC	6 & 4	5	
SRB805KC	1-2 SOLDER	5	

## STRAIGHT UNIVERSAL EMERGENCY

BATTERY TERMINAL END

Line: 1347-00



PART NUMBER	SIZE	QTY/BX	LIST PRICE
SRB804KC	888 EMERG STRA UNI	5	
SRB804KCBRS	BRASS AUTOMOTIVE	1	
SRB5010	1/0 2PC BATTERY LUGS	5	
SRB5020	2/0 2PC BATTERY LUGS	5	
SRB5030	3/0 QC UNIVERSAL COMP TERM	5	
SRB5040	4/0 QC UNIVERSAL COMP TERM	5	

## NEGATIVE BATTERY TERMINAL

BATTERY TERMINAL END

Line: 1348-00

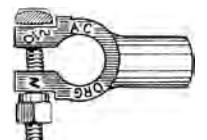

PART NUMBER	SIZE	QTY/BX	LIST PRICE
ZCB4004N	4 GA	5	
ZCB2040	2-1 GA	5	
ZCB2042	1/0 GA	5	
ZCB2044	2/0 GA	5	
ZCB30N	3/0 GA HDBT	5	
ZCB30NF	3/0 FLAG	10	
ZCB40N	4/0 GA HDBT	5	

**POSITIVE BATTERY TERMINAL END**

Line: 1349-00

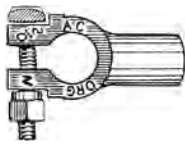

PART NUMBER	SIZE	QTY/BX	LIST PRICE
ZCB4004P	4 GA	5	
ZCB2039	2-1 GA	5	
ZCB2041	1/0 GA	5	
ZCB2043	2/0 GA	5	
ZCB30P	3/0 GA HDBT	5	
ZCB30PF	3/0 FLAG	10	
ZCB40P	4/0 GA HDBT	5	

**COPPER BATTERY TERMINAL END**

Line: 1351-00



PART NUMBER	SIZE	QTY/BX	LIST PRICE
ZCB2037	6 GA	5	
ZCB2038	4 GA	5	
ZCB4002005U	2-1 GA	5	

**BATTERY CHARGING CLIPS**

Line: 1352-00



PART NUMBER	SIZE	QTY/BX	LIST PRICE
FND815KC	5 AMP	10	
FND60HSB	10A BLACK INSL BARREL	10	
FND60HSR	10A RED INSL BARREL	10	
FND816KC	10 AMP	10	
FND817KC	25 AMP	10	
FND818KC	50 AMP	5	
FND26B	817KC BLACK INSULATOR	10	
FND26R	817KC RED INSULATOR	10	
FND49B	816KC BLACK INSULATOR	10	
FND49R	816KC RED INSULATOR	10	
FND62B	815KC BLACK INSULATOR	10	
FND62R	815KC RED INSULATOR	10	

**BATTERY POST ADAPTERS**

Line: 1353-00

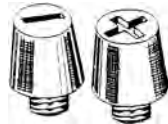

PART NUMBER	SIZE	QTY/BX	LIST PRICE
FND-DBAN1	5/16 NEG STUD-POST	5	
FND-DBAN2	3/8 NEG STUD-POST	5	
FND-DBAP	3/8 POS STUD-POST	5	
FND99007	3/8STUD-POST PAIR	5	

**BATTERY POST CLEANER**

Line: 1354-00



PART NUMBER	SIZE	QTY/BX	LIST PRICE
FND829KC	TOOL	1	

**BATTERY POST SHIM CAP/WASHER**

Line: 1355-00



PART NUMBER	SIZE	QTY/BX	LIST PRICE
FND6622	BATTERY WASHER-PAIR	25	
FND821KC	SHIM	25	

**BOOSTER CABLE & CHARGE CLIPS**

Line: 1356-00



PART NUMBER	SIZE	QTY/BX	LIST PRICE
FND75BKC	50 AMP	1	
FND150BKC	200 AMP	1	
FND400BKC	400 AMP	1	

**BATTERY BOOSTER CABLES**

HEAVY DUTY TYPE

Line: 1356-01



PART NUMBER	SIZE	QTY/BX	LIST PRICE
JYN44216	4GA X 16FT HVY DUTY	1	



**CALL - 1 (800) 723-2826**

**CALL: (800) 723-2826**

## HEAVY DUTY CABLE LUGS

PLAIN COPPER

Line: 1357-00



PART NUMBER	SIZE	QTY/BX	LIST PRICE
STB0804	#8 X 1/4	10	
STB0805	#8 X 5/16	10	
STB0806	#8 X 3/8	10	
STB0808	#8 X 1/2	10	
STB1601	#6 X 1/4	10	
STB4851J	#6 X 5/16	10	
STB0606	#6 X 3/8	10	
STB0608	#6 X 1/2	10	
STB1591	#4 X 1/4	10	
STB1592	#4 X 5/16	10	
STB0406	#4 X 3/8	10	
STB0408	#4 X 1/2	10	
STB1580	#2 X 1/4	10	
STB1581	#2 X 5/16	10	
STB0206	#2 X 3/8	10	
STB0208	#2 X 1/2	10	
STB0104	#1 X 1/4	10	
STB0105	#1 X 5/16	10	
STB4852J	#1 X 3/8	10	
STB0108	#1 X 1/2	10	
STB1004	1/0 X 1/4	10	
STB1005	1/0 X 5/16	10	
STB1006	1/0 X 3/8	10	
STB1008	1/0 X 1/2	10	
STB2004	2/0 X 1/4	10	
STB2005	2/0 X 5/16	10	
STB2006	2/0 X 3/8	10	
STB2008	2/0 X 1/2	10	
STB3006	3/0 X 3/8	10	
STB3008	3/0 X 1/2	10	
STB4856J	4/0 X 3/8	10	
STB4010	4/0 X 5/8	10	
STB4008	4/0 X 1/2	10	

## PRIMARY AUTOMOTIVE ELECTRICAL WIRE

100 FOOT ROLL

Line: 1358-00



PART NUMBER	SIZE	QTY/BX	LIST PRICE
SVB18Y	18 GAUGE YELLOW	1	
SVB18W	18 GAUGE WHITE	1	
SVB18R	18 GAUGE RED	1	
SVB18V	18 GAUGE PURPLE	1	
SVB18P	18 GAUGE PINK	1	
SVB18O	18 GAUGE ORANGE	1	

(continued...)

## PRIMARY AUTOMOTIVE ELECTRICAL WIRE (cont.)

100 FOOT ROLL

Line: 1358-00



PART NUMBER	SIZE	QTY/BX	LIST PRICE
SVB18G	18 GAUGE GREEN	1	
SVB18GR	18 GAUGE GRAY	1	
SVB18BR	18 GAUGE BROWN	1	
SVB18B	18 GAUGE BLUE	1	
SVB18BK	18 GAUGE BLACK	1	
SVB16Y	16 GAUGE YELLOW	1	
SVB16W	16 GAUGE WHITE	1	
SVB16R	16 GAUGE RED	1	
SVB16O	16 GAUGE ORANGE	1	
SVB16G	16 GAUGE GREEN	1	
SVB16BR	16 GAUGE BROWN	1	
SVB16B	16 GAUGE BLUE	1	
SVB16BK	16 GAUGE BLACK	1	
SVB14Y	14 GAUGE YELLOW	1	
SVB14W	14 GAUGE WHITE	1	
SVB14V	14 GAUGE VIOLET	1	
SVB14R	14 GAUGE RED	1	
SVB14P	14 GAUGE PINK	1	
SVB14O	14 GAUGE ORANGE	1	
SVB14G	14 GAUGE GREEN	1	
SVB14GR	14 GAUGE GRAY	1	
SVB14BR	14 GAUGE BROWN	1	
SVB14B	14 GAUGE BLUE	1	
SVB14BK	14 GAUGE BLACK	1	
SVB12Y	12 GAUGE YELLOW	1	
SVB12W	12 GAUGE WHITE	1	
SVB12R	12 GAUGE RED	1	
SVB12O	12 GAUGE ORANGE	1	
SVB12G	12 GAUGE GREEN	1	
SVB12BR	12 GAUGE BROWN	1	
SVB12B	12 GAUGE BLUE	1	
SVB12BK	12 GAUGE BLACK	1	
SVB12BK5CFT	12 GAUGE BLACK	1	
SVB10Y	10 GAUGE YELLOW	1	
SVB10W	10 GAUGE WHITE	1	
SVB10R	10 GAUGE RED	1	
SVB10O	10 GAUGE ORANGE	1	
SVB10G	10 GAUGE GREEN	1	
SVB10BR	10 GAUGE BROWN	1	
SVB10B	10 GAUGE BLUE	1	
SVB10BK	10 GAUGE BLACK	1	
SVB08W	8 GAUGE WHITE	1	

(continued...)

**PRIMARY AUTOMOTIVE ELECTRICAL WIRE (cont.)**

100 FOOT ROLL

Line: 1358-00

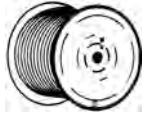

PART NUMBER	SIZE	QTY/BX	LIST PRICE
SVB08R	8 GAUGE RED	1	
SVB08G	8 GAUGE GREEN	1	
SVB08BK	8 GAUGE BLACK	1	

**PRIMARY AUTOMOTIVE ELECTRICAL WIRE**

1,000 FOOT ROLL

Line: 1358-01



PART NUMBER	SIZE	QTY/BX	LIST PRICE
JNN18BK	18 GAUGE BLACK	1	
JNN16Y	16 GAUGE YELLOW	1	
JNN16W	16 GAUGE WHITE	1	
JNN16R	16 GAUGE RED	1	
JNN16O	16 GAUGE ORANGE	1	
JNN16G	16 GAUGE GREEN	1	
JNN16BR	16 GAUGE BROWN	1	
JNN16B	16 GAUGE BLUE	1	
JNN16BK	16 GAUGE BLACK	1	
JNN14Y	14 GAUGE YELLOW	1	
JNN14W	14 GAUGE WHITE	1	
JNN14R	14 GAUGE RED	1	
JNN14O	14 GAUGE ORANGE	1	
JNN14G	14 GAUGE GREEN	1	
JNN14BR	14 GAUGE BROWN	1	
JNN14B	14 GAUGE BLUE	1	
JNN14BK	14 GAUGE BLACK	1	
JNN12BKX	12 GAUGE BLACK	1	
JNN12R	12 GAUGE RED	1	
JNN10R	10 GAUGE RED	1	
JNN10BK	10 GAUGE BLACK	1	
JNN08G	8 GAUGE GREEN	1	

**MECHANIC'S WIRE**

5LB. SPOOL

Line: 1358-02



PART NUMBER	SIZE	QTY/BX	LIST PRICE
SVB20MW	20 GAUGE	1	
SVB18MW	18 GAUGE	1	
SVB16MW	16 GAUGE	1	
SVB14MW	14 GAUGE	1	

**JACKETED MULTI CONDUCTOR PRIMARY**

100 FOOT ROLL

Line: 1358-03



PART NUMBER	SIZE	QTY/BX	LIST PRICE
AMK1274	16/4 BLK/WH/GR/RD D	1	
AMK1273X5C	16/3 BLK/WH/GRN 500 FT	1	
AMK1273	16/3 BLK/WH/GRN 100 FT	1	
AMKBC163TIN	16/3 BLK/WH/GR TINNED	1	
AMKBC162TIN	16/2 BLK/WHT TINNED	1	
AMK127	16/2 BLK/WH 100 FT	1	
AMK1254	14/4 BLK/WH/GR/RD	1	
AMK1253	14/3 BLK/WH/GRN 100 FT	1	
AMKBC143TIN	14/3 BLK/WH/GR TINNED	1	
AMKBC142TIN	14/2 BLK/WHT TINNED	1	
AMK125	14/2 BLK/WH 100 FT	1	
AMK1234	12/4 BLK/WH/GR/RD	1	
AMK1233	12/3 BLK/WH/GRN 100 FT	1	
AMKBC123TIN	12/3 BLK/WH/GR TIN	1	
AMKBC122TIN	12/2 BLK/WHT TINNED	1	
AMK123X5C	12/2 BLK/WHT 500 FT	1	
AMK123	12/2 BLK/WHT 100 FT	1	
AMK1214	10/4 BLK/WH/GR/RD	1	
AMK1213	10/3 BLK/WH/GRN	1	
AMKBC103TIN	10/3 BLK/WH/GR TINNED	1	
AMKBC102TIN	10/2 BLK/WHT TINNED	1	
AMK121	10/2 BLK/WHT	1	
AMK115	8/2 BLK/WHT	1	

**BONDED PRIMARY MULTI CONDUCTOR**

Line: 1358-04



PART NUMBER	SIZE	QTY/BX	LIST PRICE
BJLBP183	18/3 BR/YL/GR 100 FT	1	
BJLBP182	18/2 RD/BLK 100 FT	1	
BJLBP164X5C	16/4 WH/BR/YL/GR500 FT	1	
BJLBP164	16/4 WH/BR/YL/GR100 FT	1	
BJLBP163	16/3 BR/YL/GR 100 FT	1	
BJLSW162	16/2 CLEAR SPEAKER 100 FT	1	
BJLBP162	16/2 RD/BLK 100 FT	1	
BJLBP162GNBR	16/2 GN/BR 100 FT	1	
BJLBP144	14/4 WH/BR/YL/GR100 FT	1	
BJLBP143	14/3 BR/YL/GR 100 FT	1	
BJLBP1425CFT	14/2 RD/BLK 500 FT	1	
BJLBP142	14/2 RD/BLK 100 FT	1	
BJL102GW	10/2 GRN/WH 100 FT RL	1	

## TINNED SINGLE CONDUCTOR

PRIMARY WIRE

Line: 1358-06



PART NUMBER	SIZE	QTY/BX	LIST PRICE
BPJUL116WHT	16 GA WHITE TIN 100 FT	1	
BPJUL116RDT	16 GA RED TIN 100 FT	1	
BPJUL116GRT	16 GA GREEN TIN 100 FT	1	
BPJUL116BLT	16 GA BLACK TIN 100 FT	1	
BPJUL114WHT	14 GA WHITE TIN 100 FT	1	
BPJUL114RDT	14 GA RED TIN 100 FT	1	
BPJUL114GRT	14 GA GREEN TIN 100 FT	1	
BPJUL114BLT	14 GA BLACK TIN 100 FT	1	
BPJUL112WHT	12 GA WHITE TIN 100 FT	1	
BPJUL112RDT	12 GA RED TIN 100 FT	1	
BPJUL112GRT	12 GA GREEN TIN 100 FT	1	
BPJUL112BLT	12 GA BLACK TIN 100 FT	1	
BPJUL110WHT	10 GA WHITE TIN 100 FT	1	
BPJUL110RDT	10 GA RED TIN 100 FT	1	
BPJUL110GRT	10 GA GREEN TIN 100 FT	1	
BPJUL110BLT	10 GA BLACK TIN 100 FT	1	

## TRAILER LIGHT CABLE MULTI CONDUCTOR

PRIMARY WIRE

Line: 1358-10



PART NUMBER	SIZE	QTY/BX	LIST PRICE
BJMCS56	16/4 BLK/R/BRW/W	1	
BJMCS56C5	16/4 X 500 FT BLK/R/BRW/W	1	
BJMCS57	16/6 R/W/BL/B/G/Y	1	
BJMCS57C5	16/6 X 500 FT R/W/BL/B/G/Y	1	
BJMCS58	14/4 BLK/R/BRW/W	1	
BJMCS59	14/6 R/W/BL/B/G/Y	1	
BJMCS60	14/7R/W/BL/B/G/Y/BLU	1	
BJMCS61	12/4 BLK/R/BRW/W	1	
BJMCS62	12/6 R/W/BL/B/G/Y	1	
BJMCS63	7 WAY (12/6-10/1)	1	

## .375 OD COPPER STARTER CABLE

INSULATED

Line: 1360-00



PART NUMBER	SIZE	QTY/BX	LIST PRICE
FPD530ROLL	6 GA RED	100	
FPD528ROLL	6 GA BLACK	100	
FPD530KC	#6 RED	25	
FPD528KC	#6 BLACK	25	
FPD529KC	#4 RED	25	
FPD524KC	#4 BLACK	25	

## .450 OD COPPER STARTER CABLE

INSULATED

Line: 1361-00



PART NUMBER	SIZE	QTY/BX	LIST PRICE
FPD524KTIN	4 GA.-BLACK TINNED	100	
FPD529KTIN	4 GA - RED TINNED	100	
FPD522KTIN	2 GA-RED TINNED	25	
FPD520KTIN	2 GA - BLK TINNED	100	
FPD522KC	#2 RED	25	
FPD520KC	#2 BLACK	25	

## .500 OD COPPER STARTER CABLE

INSULATED

Line: 1362-00



PART NUMBER	SIZE	QTY/BX	LIST PRICE
FPD521BKC	#1 BLACK	25	
FPD521KC	#1 RED	25	

## .530 OD COPPER STARTER CABLE

INSULATED

Line: 1363-00



PART NUMBER	SIZE	QTY/BX	LIST PRICE
FPD525KC	#1/0 BLACK	25	
FPD531KC	#1/0 RED	25	

## .590 OD COPPER STARTER CABLE

INSULATED

Line: 1364-00



PART NUMBER	SIZE	QTY/BX	LIST PRICE
FPD526KC	#2/0 BLACK	25	
FPD532KC	#2/0 RED	25	

## .650 OD COPPER STARTER CABLE

INSULATED

Line: 1365-00



PART NUMBER	SIZE	QTY/BX	LIST PRICE
FPD527RKC	3/0 GAUGE RED	25	
FPD527KC	3/0 BLACK	25	
FPD528BKC	4/0 GAUGE BLACK	25	





### CABLE & WIRE POLY SPLIT LOOM

100 FOOT BOX

Line: 1366-00



PART NUMBER	SIZE	QTY/BX	LIST PRICE
FRD684KC	1/4 I.D.	1	
FRD686KC	3/8 ID	1	
FRD688KC	1/2 ID	1	
FRD693KC	5/8 ID	1	
FRDM429	3/4 ID	1	
FRD16100	1 ID	1	
FRD20025	1 1/4 ID (25FT)	1	
FRD24100	1 1/2 ID	1	

### BATTERIES

ALKALINE INDUSTRIAL CELL

Line: 1366-10



PART NUMBER	SIZE	QTY/BX	LIST PRICE
CDG7526	AAA-CELL	10	
CDG7524	AA-CELL	12	
CDG7522	C-CELL	6	
CDG7520	D-CELL	6	
CDG7590	9V-9 VOLT	2	

### WIRE TERMINAL CRIMP TOOL

Line: 1367-00

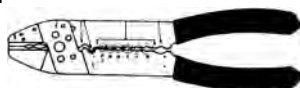

PART NUMBER	SIZE	QTY/BX	LIST PRICE
SMB1963V	1963	1	

### TERMINAL LUG CRIMPING TOOL

Line: 1368-00



PART NUMBER	SIZE	QTY/BX	LIST PRICE
FCD2036J	#8 - 4/0 GA HAMMER	1	
FCD4245	#10 - 1 GA LEVER HX	1	
FCD9921001	2/0 W/4255 CRIMPER	1	
FCD4255	8GA -6/0 LEVER HX TE	1	

### HAND COPPER CABLE CUTTER

Line: 1368-01



PART NUMBER	SIZE	QTY/BX	LIST PRICE
FCDM60	2/0 COPPER 4/0 ALUM	1	

### ELECTRICAL WIRE NUTS (SOFT)

3M SCOTCHLOK

Line: 1369-00

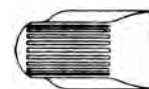

PART NUMBER	SIZE	QTY/BX	LIST PRICE
SPB1810R	AWG 18-10 RED	25	
SPB1812Y	AWG 18-12 YELLOW	25	
SPB148G	AWG 14-8 GREY	25	
SPB126B	AWG 12-6 BLUE	25	

### ELECTRICAL WIRE NUTS

3M RANGER WING

Line: 1369-01

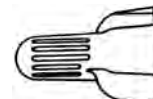

PART NUMBER	SIZE	QTY/BX	LIST PRICE
AUF312	#22-12 WIRE (YELLOW)	25	
AUF312C	#22-12 WIRE (YELLOW)	100	
AUF512	#20-8 WIRE (RED)	25	
AUF512C	#20-8 WIRE (RED)	100	
AUF188	#14-8 WIRE (GREY)	25	
AUF188C	#14-8 WIRE (GREY)	100	
AUF512GM	#14-10W (GREEN)GROUND	1000	
AUF189	#12-6 WIRE (BLUE)	25	
AUF189C	#12-6 WIRE (BLUE)	100	

### ELECTRICAL WIRE NUTS

3M RUBBER SKIRTED

Line: 1369-03



PART NUMBER	SIZE	QTY/BX	LIST PRICE
CBRBG	4/14-5/10 AWG RANGE	25	
CBROB	2/22-2/12 AWG RANGE	50	
CBRRY	2/18-2/8 AWG RANGE	50	

### IDEAL ELECTRICAL WIRE NUTS

Line: 1370-00



PART NUMBER	SIZE	QTY/BX	LIST PRICE
FFD10378A	AWG 18-16 (GREY)	25	
FFD10378AC	AWG 18-16 (GREY)	100	
FFD10379A	AWG 18-14 (BLUE)	25	
FFD10379AC	AWG 18-14 (BLUE)	100	
FFD10380A	AWG 18-14 (ORANGE)	25	
FFD10380AC	AWG 18-14 (ORANGE)	100	
FFD10381A	AWG 18-12 (YELLOW)	25	
FFD10381AC	AWG 18-12 (YELLOW)	100	
FFD10382A	AWG 18-10 (RED)	25	
FFD10382AC	AWG 18-10 (RED)	100	

### 3M DIRECT BURY MOIST PROOF

2 PIECE KITS

Line: 1372-00



PART NUMBER	SIZE	QTY/BX	LIST PRICE
SNBDBR3M	30VLT 7#18/4#12/3#10	1	
SNBDBR63M	600V 7#18/4#12/3#10	1	
SNBDBY3M	30VLT 2#18/2#12	1	
SNBDBY63M	600VLT 2#18/2#12	1	
SNB314IR	22/14 AWG BLUE IRRIG	50	
SNB316IR	22/16 AWG BLK IRRIG	30	
SNB557R	22-16 2/W RED BUTEND	25	

### 3M SCOTCH LOCK

WIRE TERMINALS

Line: 1372-01



PART NUMBER	SIZE	QTY/BX	LIST PRICE
SNBUR2	26/19 RED IDC MR	100	
SNB801BL	801 BLUE	25	
SNB901BK	901 BLACK	25	
SNB901BK50	901 BLACK	50	
SNB902BR	902 BROWN	25	
SNB903Y	903 YELLOW	25	
SNB905R	835 RED	25	
SNB972FH	14-18 FUSE HOLDER	25	

### AUTOMOTIVE FUSE HOLDERS

Line: 1373-00



PART NUMBER	SIZE	QTY/BX	LIST PRICE
ZDB3255	9 AMP FNY9	10	
ZDB3256	14 AMP FNY14	10	
ZDB3257	20 AMP FNY20	10	
ZDB4695J	20 AMP FNY20 HVY DY	10	
ZDB4696J	30 AMP FNY30 HVY DY	10	

### AUTOMOTIVE FUSES

Line: 1374-00



PART NUMBER	SIZE	QTY/BX	LIST PRICE
JJD235001	1 AMP M5X20 FASTACT	5	
JJD235002	2 AMP M5X20 FASTACT	5	
JJD235003	3 AMP M5X20 FASTACT	5	
JJD235004	4 AMP M5X20 FASTACT	5	
JJD235005	5 AMP M5X20 FASTACT	5	
JJD239001	1 AMP M5X20 SLO-BLO	5	
JJD239002	2 AMP M5X20 SLO-BLO	5	
JJD239003	3 AMP M5X20 SLO-BLO	5	

(continued...)

### AUTOMOTIVE FUSES (cont.)

Line: 1374-00



PART NUMBER	SIZE	QTY/BX	LIST PRICE
JJD239004	4 AMP M5X20 SLO-BLO	5	
JJD239005	5 AMP M5X20 SLO-BLO	5	
JJD3AG500QA	1/2 AMP QK ACT	25	
JJDAGA2	2 AMP 1/2 X 5/8 TUBE	25	
JJDAGA025	2 1/2 AMP 1/2 X 5/8 TUBE	25	
JJDAGA3	3 AMP 1/2 X 5/8 TUBE	25	
JJDAGA5	5 AMP 1/2 X 5/8 TUBE	25	
JJDAGA6	6 AMP 1/2 X 5/8 TUBE	25	
JJDAGA075	7 1/2 AMP 1/2 X 5/8 TUBE	25	
JJDAGA10	10 AMP 1/2 X 5/8 TUBE	25	
JJDAGA15	15 AMP 1/2 X 5/8 TUBE	25	
JJDAGA20	20 AMP 1/2 X 5/8 TUBE	25	
JJDAGA25	25 AMP 1/2 X 5/8 TUBE	25	
JJDAGA30	30 AMP 1/2 X 5/8 TUBE	25	
JJDAGC.5	1/2 AMP 1 1/4 TUBE	25	
JJDAGC1	1 AMP 1 1/4 TUBE	25	
JJDAGC2	2 AMP 1 1/4 TUBE	25	
JJDAGC025	2 1/2 AMP 1 1/4 TUBE	25	
JJDAGC3	3 AMP 1 1/4 TUBE	25	
JJDAGC4	4 AMP 1 1/4 TUBE	25	
JJDAGC5	5 AMP 1 1/4 TUBE	25	
JJDAGC6	6 AMP 1 1/4 TUBE	25	
JJDAGC075	7 1/2 AMP 1 1/4 TUBE	25	
JJDAGC8	8 AMP 1 1/4 TUBE	25	
JJDAGC10	10 AMP 1 1/4 TUBE	25	
JJDAGC15	15 AMP 1 1/4 TUBE	25	
JJDAGC20	20 AMP 1 1/4 TUBE	25	
JJDAGC25	25 AMP 1 1/4 TUBE	25	
JJDAGC30	30 AMP 1 1/4 TUBE	25	
JJDAGC35X	35 AMP 1 1/4 TUBE	25	
JJDAGU40	40 AMP 3/32 X 1 1/2 TUBE	10	
JJDAGU60	60 AMP 3/32 X 1 1/2 TUBE	10	
JJDAGW1	1 AMP 1/4 X 7/8 TUBE	25	
JJDAGW025	2 1/2 AMP 1/4 X 7/8 TUBE	25	
JJDAGW3	3 AMP 1/4 X 7/8 TUBE	25	
JJDAGW4	4 AMP 1/4 X 7/8 TUBE	25	
JJDAGW5	5 AMP 1/4 X 7/8 TUBE	25	
JJDAGW6	6 AMP 1/4 X 7/8 TUBE	25	
JJDAGW15	15 AMP 1/4 X 7/8 TUBE	25	
JJDAGW20	20 AMP 1/4 X 7/8 TUBE	25	
JJDAGW30	30 AMP 1/4 X 7/8 TUBE	25	
JJDAGX2	2 AMP 1/4 X 1 TUBE	25	
JJDAGX3	3 AMP 1/4 X 1 TUBE	25	
JJDAGX20	20 AMP 1/4 X 1 TUBE	25	

(continued...)

## AUTOMOTIVE FUSES (cont.)

Line: 1374-00



PART NUMBER	SIZE	QTY/BX	LIST PRICE
JJDAGX25	25 AMP 1/4 X 1 TUBE	25	
JJDAGX30	30 AMP 1/4 X 1 TUBE	25	
JJDAGY50	50 AMP 1/4 X 1 7/16 TUBE	25	
JJDAT02	2 AMP ATO STYLE	25	
JJDAT03	3 AMP ATO STYLE	25	
JJDAT04	4 AMP ATO STYLE	25	
JJDAT05	5 AMP ATO STYLE	25	
JJDAT075	7 1/2 AMP ATO STYLE	25	
JJDAT010	10 AMP ATO STYLE	25	
JJDAT015	15 AMP ATO STYLE	25	
JJDAT020	20 AMP ATO STYLE	25	
JJDAT025	25 AMP ATO STYLE	25	
JJDAT030	30 AMP ATO STYLE	25	
JJDAT040	40 AMP ATO STYLE	25	
JJDGBC5	5 AMP YELLOW CERAMIC	25	
JJDGBC8	8 AMP WHITE CERAMIC	25	
JJDGBC16	16 AMP RED CERAMIC	25	
JJDGBC25	25 AMP BLUE CERAMIC	25	
JJDMIN2	2 AMP MINI DUAL PRONG	25	ATO
JJDMIN3	3 AMP MINI DUAL PRONG	25	ATO
JJDMIN4	4 AMP MINI DUAL PRONG	25	ATO
JJDMIN5	5 AMP MINI DUAL PRONG	25	ATO
JJDMIN7-5	7.5 AMP MINI DUAL PRONG	25	ATO
JJDMIN10	10 AMP MINI DUAL PRONG	25	ATO
JJDMIN15	15 AMP MINI DUAL PRONG	25	ATO
JJDMAX20	20 AMP MAXI DUAL PRONG	10	ATO
JJDMIN20	20 AMP MINI DUAL PRONG	25	ATO
JJDMIN25	25 AMP MINI DUAL PRONG	25	ATO
JJDMAX30	30 AMP MAXI DUAL PRONG	10	ATO
JJDMIN30	30 AMP MINI DUAL PRONG	25	ATO
JJDMAX40	40 AMP MAXI DUAL PRONG	10	ATO
JJDMAX50	50 AMP MAXI DUAL PRONG	10	ATO
JJDMAX60	60 AMP MAXI DUAL PRONG	10	ATO
JJDMAX80	80 AMP MAXI DUAL PRONG	10	ATO
JJDSFE4	4 AMP 1/4 X 5/8 TUBE	25	
JJDSFE6	6 AMP 1/4 X 3/4 TUBE	25	
JJDSFE075	7 1/2 AMP 1/4 X 7/8 TUBE	25	
JJDSFE9	9 AMP 1/4 X 7/8 TUBE	25	
JJDSFE14	14 AMP 1/4 X 1 1/16 TUBE	25	
JJDSFE20	20 AMP 1/4 X 1 1/4 TUBE	25	
JJDSFE30	30 AMP 1/4 X 1 7/16 TUBE	25	

## AUTOMOTIVE FUSE HOLDERS

BUSSE

Line: 1374-03



PART NUMBER	SIZE	QTY/BX	LIST PRICE
JJDAFH2	AFH2 ATO HV DTY HLD	50	
JJDFH	FUSE HOLDER ONLY	5	
JJDFHA1	FHA1 ATO FUSE HLDR.	5	
JJDFHA2	FHA2 ATO HV DTY HLDR	5	
JJDFHM1	FHM1 MINI ATO	5	
JJDFHP1	FHP1	10	
JJDFNY1	4-20AMP 8 LOOP GLASS	5	

## AUTOMOTIVE CIRCUIT BREAKERS

LITTLEFUSE

Line: 1374-06



PART NUMBER	SIZE	QTY/BX	LIST PRICE
JJD812005	5 AMP	25	
JJD812006	6 AMP	25	
JJD812008	8 AMP	25	
JJD812010	10 AMP	25	
JJD812015	15 AMP STUD TYPE	5	
JJD812020	20 AMP STUD TYPE	5	
JJD812025	25 AMP STUD TYPE	5	
JJD812030	30 AMP STUD TYPE	5	
JJD812035	35 AMP	25	
JJD812040	40 AMP STUD TYPE	5	
JJD813015ST	15AMP STUD TYPE	5	
JJDACB20	GM PLG-IN 20 AMP	5	
JJDACB30	GM PLG-IN 30 AMP	5	
JJDCBF10	10 AMP CLIP TYPE	5	
JJDCBF15	15 AMP CLIP TYPE	5	
JJDCBF20	20 AMP CLIP TYPE	5	
JJDCBF25	25 AMP CLIP TYPE	5	
JJDCBF30	30 AMP CLIP TYPE	5	
JJDCBF35	35 AMP CLIP TYPE	5	
JJDCBF40	40 AMP CLIP TYPE	5	
JJDFLR536552	2-TERM UNIV FLASHER	10	
JJUCB30B	30AMP UNIV SNAP-OFF	500	



**CALL - 1 (800) 723-2826**

# SECTION 15 PRODUCT INDEX



## ANCHORING PRODUCTS

Line Description	Alpha	Line#	Page#
RED-HEAD MULTI-SET DROP-IN ANCHOR	<b>SZB</b>	<b>1375-00</b>	<b>15-4</b>
RED-HEAD MULTI-SET DROP-IN ANCHOR - STAINLESS STEEL	<b>BJV</b>	<b>1375-01</b>	<b>15-4</b>
STANDARD DROP-IN ANCHORS - GLOBAL	<b>CEX</b>	<b>1375-05</b>	<b>15-4</b>
STANDARD DROP-IN ANCHORS - 304 ST/STL - GLOBAL	<b>CEY</b>	<b>1375-06</b>	<b>15-4</b>
RED HEAD NON-DRILLING ANCHOR	<b>TAB</b>	<b>1376-00</b>	<b>15-4</b>
RED HEAD MULTI-SET ANCHOR SETTING TOOL	<b>TBB</b>	<b>1377-00</b>	<b>15-4</b>
RED HEAD NON-DRILLING SETTING TOOL	<b>TCB</b>	<b>1378-00</b>	<b>15-4</b>
SHORT LAG SCREW SHIELDS	<b>TDB</b>	<b>1379-00</b>	<b>15-4</b>
LONG LAG SCREW SHIELDS	<b>TEB</b>	<b>1380-00</b>	<b>15-4</b>
DOUBLE EXPANSION MACHINE BOLT SHIELDS	<b>TFB</b>	<b>1381-00</b>	<b>15-5</b>
SINGLE EXPANSION MACHINE BOLT SHIELDS	<b>TKB</b>	<b>1385-00</b>	<b>15-5</b>
CHEMICAL CONCRETE ANCHOR STUD CAPULES	<b>BEY</b>	<b>1385-10</b>	<b>15-5</b>
CHISEL STUD ASSEMBLY WITH NUT & WASHER	<b>BSG</b>	<b>1385-11</b>	<b>15-5</b>
CONICAL PLASTIC SCREW ANCHORS	<b>TLB</b>	<b>1386-00</b>	<b>15-5</b>
TOGGLER ALLIGATOR SOLID WALL ANCHORS	<b>BPN</b>	<b>1386-01</b>	<b>15-5</b>
POLY RIBBED/WING ANCHORS & KITS	<b>CCM</b>	<b>1386-02</b>	<b>15-5</b>
LEAD WOOD SCREW ANCHORS	<b>TMB</b>	<b>1388-00</b>	<b>15-6</b>
PLASTIC PLUG SCREW ANCHORS	<b>TNB</b>	<b>1389-00</b>	<b>15-6</b>
POLY PRO RIBBED/WING WALL BOARD ANCHORS	<b>TNB</b>	<b>1389-01</b>	<b>15-6</b>
TOGGLER BRAND HOLLOW WALL ANCHORS	<b>BPP</b>	<b>1389-02</b>	<b>15-6</b>
TOGGLER SNAP SCREW SELF DRILL WALL ANCHOR	<b>CHH</b>	<b>1389-03</b>	<b>15-6</b>
NYLON ONE STEP WALLBOARD ANCHOR	<b>ALF</b>	<b>1389-05</b>	<b>15-6</b>
NYLON ONE STEP WALLBOARD ANCHOR KITS	<b>APK</b>	<b>1389-06</b>	<b>15-6</b>
ZINC EZ ONE STEP WALLBOARD ANCHOR	<b>ALF</b>	<b>1389-10</b>	<b>15-6</b>
PLASTIC ANCHOR KIT	<b>TLB</b>	<b>1391-00</b>	<b>15-7</b>
LIGHT ROSETT WALL BOARD ANCHORS	<b>BJX</b>	<b>1391-10</b>	<b>15-7</b>
HEAVY DUTY ROSETT WALL & MASONRY ANCHORS	<b>BYJ</b>	<b>1391-11</b>	<b>15-7</b>
RED HEAD STEEL WEDGE ANCHOR	<b>TRB</b>	<b>1392-00</b>	<b>15-7</b>
RED HEAD STAINLESS STEEL WEDGE ANCHOR	<b>TSB</b>	<b>1393-00</b>	<b>15-8</b>
RED HEAD GALVANIZED WEDGE ANCHOR	<b>AUW</b>	<b>1393-01</b>	<b>15-8</b>
RED HEAD 316 STAINLESS STEEL WEDGE ANCHOR	<b>AUX</b>	<b>1393-02</b>	<b>15-8</b>
RED HEAD STUD ANCHOR	<b>TTB</b>	<b>1394-00</b>	<b>15-9</b>
GLOBAL STEEL WEDGE ANCHOR	<b>BMD</b>	<b>1394-10</b>	<b>15-9</b>
GLOBAL STAINLESS STEEL 304 WEDGE ANCHOR	<b>BTF</b>	<b>1394-11</b>	<b>15-10</b>
DYNABOLT ACORN NUT SLEEVE ANCHOR	<b>TUB</b>	<b>1395-00</b>	<b>15-10</b>
DYNABOLT FLAT HEAD SLEEVE ANCHOR	<b>TUB</b>	<b>1396-00</b>	<b>15-10</b>
DYNABOLT HEX NUT SLEEVE ANCHOR	<b>TUB</b>	<b>1397-00</b>	<b>15-10</b>
DYNABOLT ROUND HEAD SLEEVE ANCHOR	<b>TUB</b>	<b>1399-00</b>	<b>15-11</b>
GLOBAL ACORN NUT SLEEVE ANCHOR	<b>BTG</b>	<b>1399-01</b>	<b>15-11</b>

(CONTINUED...)

# SECTION 15 PRODUCT INDEX



## ANCHORING PRODUCTS *(continued)*

Line Description	Alpha	Line#	Page#
GLOBAL FLAT HEAD SLEEVE ANCHOR	BTH	1399-02	15-11
GLOBAL HEX NUT SLEEVE ANCHOR	BTJ	1399-03	15-11
GLOBAL ROUND HEAD SLEEVE ANCHOR	BTK	1399-04	15-11
EXPANSION CAULKING ANCHOR	TVB	1402-00	15-11
HAMMER DRIVE ANCHOR STEEL PIN	ART	1402-01	15-11
HAMMER DRIVE ANCHOR STAINLESS STEEL PIN	ARV	1402-02	15-12
CAULKING ANCHOR SETTING TOOL	TWB	1403-00	15-12
MASONRY PIN GRIP RIVET	TXB	1404-00	15-12
ROUND HEAD 1 PIECE DRIVE ANCHORS	UCB	1406-00	15-12
COUNTERSUNK 1 PIECE DRIVE ANCHORS	UEB	1408-00	15-12
GLOBAL SELF DRILL ANCHORS STEEL	SXB	1409-00	15-12
1/4" HEAD PIN DRIVE	ANY	1409-05	15-12
1/4" HEAD PIN DRIVE TOOL	ANZ	1409-06	15-12
WEJIT STEEL CONCRETE ANCHORS	JRR	1410-01	15-13
TAPCON BRAND MASONRY SCREW SLOTTED HEX WASHER	AMD	1411-00	15-13
TAPCON BRAND MASONRY SCREW PHILLIPS FLAT	AME	1411-01	15-13
TAPCON BRAND CONDRIVE INSTALLATION TOOL	AMF	1411-02	15-14
TAPCON BRAND INSTALLATION DRILL	AMG	1411-03	15-14
TAPCON 1000 SERIES INSTALLATION TOOL PARTS	AMH	1411-04	15-14
TAPCON 2000 SERIES INSTALLATION TOOL PARTS	AMJ	1411-05	15-14
GLOBAL MASONRY SCREW SLOTTED HEX WASHER	CGP	1411-06	15-14
GLOBAL MASONRY SCREW PHILLIPS FLAT HEAD	CGP	1411-07	15-14
HANGERMATE THREADED ROD ANCHORING SYSTEM	BHT	1411-20	15-15
TOGGLE BOLTS WITH SPRING WING NUTS	UAB	1412-00	15-15
MUSHROOM HEAD TOGGLE BOLTS WITH SPRING WINGS	UAC	1412-05	15-15
SPRING TOGGLE WING NUTS	DJD	1413-00	15-16
HOLLOW WALL DRIVE MOLLY ANCHORS	UBB	1414-00	15-16
HOLLOW WALL REGULAR MOLLY ANCHORS	UBB	1415-00	15-16
SANKO BRAND ANCHORS	AYD	1415-05	15-16
EASY TOGGLER HOLLOW WALL ANCHORS	BJW	1415-06	15-16
STANDARD KAP TOGGLES NO SCREWS	CGW	1415-08	15-16
22 CALIBER POWER LOADS	UFB	1416-00	15-16
27 CALIBER POWER LOADS	UFB	1416-05	15-16
1/4" POWER PINS	UGB	1417-00	15-16

# SECTION 15 PRODUCT INDEX



## HARDWARE PRODUCTS

Line Description	Alpha	Line#	Page#
TURNBUCKLES EYE/EYE DROP FORGED GALVANIZED	ULB	1421-00	15-17
MIDGET TURNBUCKLES ALUMINUM	UMB	1422-00	15-17
TURNED EYE LAG SCREWS - ZINC PLATED	UNB	1423-00	15-17
SCREW HOOK W/LAG SCREW THREAD	ANX	1423-05	15-17
U-BOLTS WITH PLATES - ZINC PLATED	UPB	1424-00	15-17
U-BOLTS NO PLATES - ZINC PLATED	URB	1425-00	15-18
U-BOLTS HOT DIPPED GALVANIZED WITH NUTS	BJT	1426-01	15-18
U-BOLTS HOT DIPPED STAINLESS STEEL 304 WITH NUTS	BJZ	1426-02	15-18
U-BOLTS SQUARE BEND STEEL ZINC/GALVANIZED	BKD	1426-03	15-19
TURNED EYE BOLTS WITH NUTS - ZINC	USB	1427-00	15-19
DROP FORGED EYE BOLTS - GALVANIZED	UTB	1428-00	15-20
DROP FORGED SHOULDER EYE BOLTS - GALVANIZED	UUB	1429-00	15-20
DROP FORGED HEAT TREATED MACHINE EYE BOLTS - PLAIN	UVB	1430-00	15-20
DROP FORGED HEAT TREATED SHOULDER MACHINE EYE BOLTS - PLAIN	UWB	1431-00	15-21
DROP FORGED BLANK ROD END	UXB	1432-00	15-21
DROP FORGED EYE NUT REGULAR PATTERN - PLAIN	ATH	1432-01	15-21
DROP FORGED EYE NUT REGULAR PATTERN - HD GALVANIZED	ATJ	1432-02	15-21
DROP FORGED EYE NUT HEAVY DUTY - PLAIN	ATK	1432-03	15-21
ECOMONY SCREW PIN ANCHOR SHACKLE	AYR	1432-10	15-22
SCREW PIN ANCHOR SHACKLE	AYT	1432-11	15-22
DROP FORGED SHACKLE SC PIN ANCHOR - GALVANIZED	UYB	1433-00	15-22
DROP FORGED SHACKLE SC PIN CHAIN - GALVANIZED	VAB	1435-00	15-22
DROP FORGED SHACKLE SC PIN CHAIN - PLAIN	VBB	1436-00	15-22
DROP FORGED SHACKLE ROUND PIN ANCHOR - GALVANIZED	VDB	1437-00	15-22
DROP FORGED SHACKLE ROUND PIN CHAIN - GALVANIZED	VFB	1439-00	15-22
DROP FORGED SHACKLE ROUND PIN CHAIN - PLAIN	VHB	1440-00	15-23
DROP FORGED SHACKLE SAFETY CHAIN - GALVANIZED	VKB	1443-00	15-23
DROP FORGED WIRE ROPE CLIPS - GALVANIZED / ST/STL	VMB	1445-00	15-23
MALLEABLE WIRE ROPE CLIPS - GALVANIZED	VPB	1447-00	15-23
WIRE ROPE THIMBLES - GALVANIZED	VRB	1448-00	15-24
CLEVIS GRAB HOOK DROP FORGED H.T. GALVANIZED	VSB	1449-00	15-24
CLEVIS SLIP HOOK DROP FORGED H.T. GALVANIZED	VTB	1450-00	15-24
CLEVIS GRAB HOOK DROP FORGED H.T. PLAIN	VUB	1451-00	15-24
CLEVIS SLIP HOOK DROP FORGED H.T. PLAIN	VVB	1452-00	15-24
SAFETY SLIP HOOK H.T. DROP FORGED - PLAIN	HWD	1453-00	15-24
S-HOOKS STEEL ZINC	VWB	1454-00	15-24
CHAIN LAP LINKS ZINC PLATED	VXB	1455-00	15-25
DROP FORGED CONNECTING LINKS - PLAIN	VZB	1456-00	15-25
THREADED FEMALE YOKE ENDS - UNF - PLAIN	DVC	1471-00	15-25
CHAIN LINK COLD SHUTS STEEL	JPF	3402-00	15-25

### RED HEAD MULTI-SET ANCHORS

DROP-IN ANCHOR

Line: 1375-00



PART NUMBER	SIZE	QTY/BX	LIST PRICE
SZB-RM14	1/4	100	
SZB-RM38	3/8	50	
SZB-RM12	1/2	50	
SZB-RM58	5/8	25	
SZB-RM34	3/4	25	

### RED HEAD MULTI-SET ANCHORS

DROP-IN ANCHOR, STAINLESS STEEL

Line: 1375-01



PART NUMBER	SIZE	QTY/BX	LIST PRICE
BJVSRM14	1/4-20 - 3/8 DRILL	100	
BJVSRM38	3/8-16 - 1/2 DRILL	50	
BJVSRM12	1/2-13 - 5/8 DRILL	50	
BJVSRM58	5/8-11 - 7/8 DRILL	25	
BJVSRM34	3/4-10 - 1" DRILL	25	

### STANDARD DROP-IN ANCHOR

Line: 1375-05



PART NUMBER	SIZE	QTY/BX	LIST PRICE
CEX04	1/4-20	100	
CEX06	3/8-16	50	
CEX08	1/2-13	50	
CEX10	5/8-11	25	
CEX12	3/4	25	

### STANDARD DROP-IN ANCHOR

STAINLESS STEEL

Line: 1375-06



PART NUMBER	SIZE	QTY/BX	LIST PRICE
CEY04	1/4-20	100	
CEY06	3/8-16	50	
CEY08	1/2-13	50	
CEY10	5/8-11	25	
CEY12	3/4	25	

### RED HEAD NON-DRILLING ANCHOR

Line: 1376-00

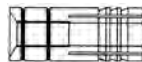

PART NUMBER	SIZE	QTY/BX	LIST PRICE
TAB-J14	1/4	100	
TAB-J58	5/8	25	
TAB-J34	3/4	25	

### RED HEAD MULTI-SET ANCHOR

DRIVING TOOL ONLY

Line: 1377-00



PART NUMBER	SIZE	QTY/BX	LIST PRICE
TBB-RT14	1/4	1	
TBB-RT38	3/8	1	
TBB-RT12	1/2	1	
TBB-RT58	5/8	1	
TBB-RT34	3/4	1	

### RED HEAD NON DRILLING SETTING TOOL

Line: 1378-00



PART NUMBER	SIZE	QTY/BX	LIST PRICE
TCB-JD14	1/4	1	
TCB-JD38	3/8	1	
TCB-JD12	1/2	1	
TCB-JD58	5/8	1	
TCB-JD34	3/4	1	

### SHORT LAG SCREW ANCHOR SHEILD

Line: 1379-00



PART NUMBER	SIZE	QTY/BX	LIST PRICE
TDB-LS140	1/4 X 1	50	
TDB-LS160	5/16 X 1 1/4	50	
TDBLS380	3/8 X 1 3/4	50	
TDB-LS120	1/2 X 2	25	
TDB-LS580	5/8 X 2	25	
TDB-LS340	3/4 X 2	10	

### LONG LAG SCREW ANCHOR SHEILD

Line: 1380-00



PART NUMBER	SIZE	QTY/BX	LIST PRICE
TEB-LS146	1/4 X 1 1/2	50	
TEB-LS166	5/16 X 1 3/4	50	
TEB-LS386	3/8 X 2 1/2	50	
TEB-LS126	1/2 X 3	25	
TEB-LS586	5/8 X 3 1/2	25	
TEB-LS346	3/4 X 3 1/2	10	



CALL - 1 (800) 723-2826

CALL: (800) 723-2826

## MACHINE BOLT SHEILD

DOUBLE EXPANSION

Line: 1381-00



PART NUMBER	SIZE	QTY/BX	LIST PRICE
TFB04	1/4	100	
TFB05	5/16	50	
TFB06	3/8	50	
TFB08	1/2	25	
TFB10	5/8	25	
TFB12	3/4	10	

## MACHINE BOLT SHEILD

SINGLE EXPANSION

Line: 1385-00

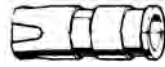

PART NUMBER	SIZE	QTY/BX	LIST PRICE
TKB04	1/4	50	
TKB05	5/16	50	
TKB06	3/8	50	
TKB08	1/2	25	
TKB10	5/8	25	
TKB12	3/4	10	

## CHEMICAL CONCRETE ANCHOR STUD

CAPSULES

Line: 1385-10



PART NUMBER	SIZE	QTY/BX	LIST PRICE
BEY06	3/8	10	
BEY08	1/2	10	
BEY10	5/8	10	
BEY12	3/4	10	
BEY14	7/8	5	
BEY16	1	5	

## CHISEL STUD ASSEMBLY

WITH NUTS & WASHERS

Line: 1385-11



PART NUMBER	SIZE	QTY/BX	LIST PRICE
BSG06G2	3/8-16 X 5 - GRADE 2	10	
BSG06304SS	3/8-16 X 5 - 304 STAINLESS STEEL	1	
BSG08G2	1/2-13 X 6 1/4 - GRADE 2	10	
BSG08304	1/2-13 X 6 1/4 - 304 STAINLESS STEEL	1	
BSG10G2	5/8-11X 7 1/2 - GRADE 2	10	
BSG10304	5/8-11X 7 1/2 - 304 STAINLESS STEEL	1	
BSG12G2	3/4-10X 9 1/2 - GRADE 2	10	
BSG12304	3/4-10X 9 1/2 - 304 STAINLESS STEEL	1	
BSG14G2	7/8-9X 10 1/4 - GRADE 2	1	
BSG14304	7/8-9X10 1/4 - 304 STAINLESS STEEL	1	
BSG16G2	1-8 X 11 3/4 - GRADE 2	1	
BSG16304	1-8 X 11 3/4 - 304 STAINLESS STEEL	1	

## PLASTIC CONICAL SCREW ANCHORS

Line: 1386-00



PART NUMBER	SIZE	QTY/BX	LIST PRICE
TLB6824	6-8 X 3/4	100	
TLBLK326	6-12 X 1 (UNIVERSAL)	100	
TLB81028	8-10 X 7/8	100	
TLB101232	10-12 X 1 (RED)	100	
TLB141648	14-16 X 1 1/2	100	

## ALLIGATOR SOLID WALL ANCHOR

TOGGLER

Line: 1386-01



PART NUMBER	SIZE	QTY/BX	LIST PRICE
BPN13101	#12 - #14 SCREW (1/4 DRILL)	100	
BPN13102	#14 - 5/16 SCREW (5/16 DRILL)	100	
BPN13103	#8 - #10 SCREW (3/16 DRILL)	200	

## POLY PRO RIBBED/WING ANCHOR

ANCHORS & KITS

Line: 1386-02



PART NUMBER	SIZE	QTY/BX	LIST PRICE
CCMPS0608SP	#6-8 X 1 1/4	100	
CCMPS1012SP	#10-12 X 1 7/16	100	
CCM12141648	12-14-16X1 1/2 (GREEN)	100	
CCM46828	4-6-8 X 7/8 (YELLOW)	100	
CCM8101240	8-10-12 X 1 1/4 (BLUE)	100	
CCM8101240Y	8-10-12 X 1 1/4 (YELLOW)	100	
CCM468JAR	6 X 3/4 COMBO PAN (100PC. JAR KIT)	1	
CCM10125BOX	10 X 1 1/4 COMBO PAN (100PC. JAR KIT)	1	
CCM81012CJAR	10 X 1 COMBO PAN (100PC. JAR KIT)	1	
CCM101248	10-12 X 1 1/2 (BLUE)	100	
CCM121416CJAR	14 X 1 1/4 COMBO PAN (50PC. JAR KIT)	1	



## LEAD WOOD SCREW ANCHORS

Line: 1388-00



PART NUMBER	SIZE	QTY/BX	LIST PRICE
TMB6824	6-8 X 3/4	100	
TMB6832	6-8 X 1	100	
TMB6848	6-8 X 1 1/2	100	
TMB101424	10-14 X 3/4	100	
TMB101432	10-14 X 1	100	
TMB101448	10-14 X 1 1/2	100	
TMB161832X	16-18 X 1	100	
TMB161848	16-18 X 1 1/2	50	

## PLASTIC PLUG SCREW ANCHORS

Line: 1389-00



PART NUMBER	SIZE	QTY/BX	LIST PRICE
TNB11070	1-2-3 X 1 - YELLOW	100	
TNB11071	4-5-6 X 3/4 - WHITE	100	
TNB11072	4-5-6 X 1 - WHITE	100	
TNB11073	4-5-6 X 1 1/2 - WHITE	100	
TNB11074	7-8-9 X 3/4 - RED	100	
TNB11075	7-8-9 X 1 - RED	100	
TNB11076	7-8-9 X 1 1/2 - RED	100	
TNB11077	10-11-12 X 1 - GREEN	100	
TNB11078	10-11-12 X 1 1/4 - GREEN	100	
TNB11079	10-11-12 X 1 1/2 - GREEN	100	
TNB11080	10-11-12 X 2 - GREEN	100	
TNB11081	13-14-15 X 1 - BLUE	100	
TNB11082	13-14-15 X 1 1/2 - BLUE	100	
TNB11083	13-14-15 X 2 - BLUE	100	
TNB11084	16-17-18 X 1 1/2 - ORANGE	100	
TNB11085	16-17-18 X 2 - ORANGE	100	
TNB11086	16-17-18 X 2 1/2 - ORANGE	100	
TNB11088	20-24 X 2 - GRAY	100	
TNB11089	20-24 X 2 1/2 - GRAY	100	

## POLY - TOGGLER WALL ANCHORS

Line: 1389-01



PART NUMBER	SIZE	QTY/BX	LIST PRICE
TNB2303	3/8 SHORT	100	
TNB2304	1/2 MEDIUM	100	
TNB2305	5/8 LONG	100	
APY100	2 1/2 (W/ WASHER HEAD - EZ)	50	

## TOGGLER BRAND HOLLOW WALL ANCHORS

Line: 1389-02



PART NUMBER	SIZE	QTY/BX	LIST PRICE
BPP11009	1/8-1/4 WALL THK	100	
BPP11010	3/8-1/2 WALL THK	100	
BPP11011	5/8-3/4 WALL THK	100	
BPP11012	3/8-1/2 PICTURE HOOK	100	
BPP11022	3/8-1/2 PEG BRD ANCHOR	50	
BPP11023	3/8-1/2 SHELF ANCHOR	50	

## TOGGLER SNAP SC SELF DRILL WALL ANCHOR

Line: 1389-03



PART NUMBER	SIZE	QTY/BX	LIST PRICE
CHH30012	W 8X1 1/2 COMBO SC	50	
CHH30032	#6X1 1/4 MINI SPM	50	

## NYLON ONE-STEP WALLBOARD ANCHOR

Line: 1389-05

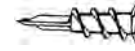

PART NUMBER	SIZE	QTY/BX	LIST PRICE
ALF100S	#6 X 1 1/4	100	
ALF100	#8-10 X 1 1/2	100	

## NYLON ONE-STEP WALLBOARD ANCHOR KITS

Line: 1389-06



PART NUMBER	SIZE	QTY/BX	LIST PRICE
APKKIT	ANC/10 X 1SC 50 SETS	1	
APKKITEZ	25 EZ MTL ANC W/SCRS	1	
APKKITMINI	W/6 X 1 COMBO SMS	1	
APKKITSMML	EZ ANC/10X1SC/25SET	1	
APK6125NS	6 X 1 1/4 CMBPAN/SMNYL	1	
APK8125N	8 X 1 1/4 COMBOPAN/NYL	1	
APK8125Z	8 X 1 1/4 COMBOPAN/ZNC	1	

## ZINC EZ ONE-STEP WALLBOARD ANCHORS

Line: 1389-10



PART NUMBER	SIZE	QTY/BX	LIST PRICE
ALFEZ100	6-8-10 X 1 1/2	100	

## PLASTIC ANCHOR KITS

Line: 1391-00



PART NUMBER	SIZE	QTY/BX	LIST PRICE
TPB68CDBOX	6/8X7/8 W/COMBO SCREW	1	
TPB6AF	6-8 X 3/4 W/SC/DR.	1	
TPB6AFHXBOX	6-8 X 3/4 HX/WHD	1	
TPB6-12UAF	6-12 X 1 UNIVERSAL	1	
TPB8AF	8-10 X 7/8 W/SC/DR	1	
TPB8AFHXBOX	8-10 X 7/8 HX/WHD	1	
TPB810CDBOX	8-10X7/8 PAN/COMBOBX	1	
TPB10AFHX	10 X 1SL/HX SC JAR	1	
TPB10AF	10-12X1 W/SC/DRL JAR	1	
TPB10AFBOX	10-12 X 1 W/SC/DR	1	
TPB10AFCB	10-12 X 1 W/COMBO SC	1	
TPB10AFHXBOX	10-12 X 1 W/HX SC	1	
TPB10AFSQJ	10-12 X 1 W/SQ DRVSC	1	
TPB10SLPNBOX	10-12 X 1 SLT PAN	1	
TPB1012CDBOX	10-12X1 PAN/COMBO BX	1	
TPB12AFHX	12 X1SL HX SC JAR	1	
TPB14AF	14-16 X 1 3/8 W/SC D	1	
TPB14AFHX	14-16 X 1 1/2 W/SC	1	
TPB14SLPNBOX	14-16 X 1 1/2 SLTPN	1	
TPB1416CDBOX	14/16 X 1 1/2 W/COMBO	1	

## LIGHT ROSETT WALL BOARD ANCHORS

Line: 1391-10



PART NUMBER	SIZE	QTY/BX	LIST PRICE
BJX04ERL	RED 1/4 #6/#8 SC	100	
BJX05EBL	BLUE 5/16 #10/#12 SC	50	

## HEAVY DUTY ROSETT ANCHORS

WALL AND MASONRY ANCHORS

Line: 1391-11



PART NUMBER	SIZE	QTY/BX	LIST PRICE
BJYERBHK	BLUE/HOOK 3/8/3/4	25	
BJYERBPH	BLUE/SCR 3/8/3/4	25	
BJYERBSE	BLUE/EYE 3/8/3/4	25	
BJYERBSH	BLUE/L HOOK 3/8/3/4	25	
BJYERBSP	BLUE/SPACER 3/8/3/4	25	
BJYERRHK	RED/HOOK 3/4-1 1/4	25	
BJYERRPH	RED/SCR 3/4-1 1/4	25	
BJYERRSE	RED/EYE 3/4-1 1/4	25	
BJYERRSH	RED/L HOOK 3/4-1 1/4	25	
BJYERRSP	RED/SPACER 3/4-1 1/4	25	

## RED HEAD STEEL WEDGE ANCHOR

Line: 1392-00



PART NUMBER	SIZE	QTY/BX	LIST PRICE
TRB-WS1416	1/4 X 1 3/4	100	
TRB-WS1422	1/4 X 2 1/4	100	
TRB-WS1432	1/4 X 3 1/4	100	
TRB-WS3822	3/8 X 2 1/4	50	
TRB-WS3826	3/8 X 2 3/4	50	
TRB-WS3830	3/8 X 3	50	
TRB-WS3836	3/8 X 3 3/4	50	
TRB-WS3850	3/8 X 5	50	
TRB-WS1226	1/2 X 2 3/4	25	
TRB-WS1236	1/2 X 3 3/4	25	
TRB-WS1242	1/2 X 4 1/4	25	
TRB-WS1254	1/2 X 5 1/2	25	
TRB-WS1270	1/2 X 7	25	
TRB-WS5834	5/8 X 3 1/2	10	
TRB-WS5842	5/8 X 4 1/4	10	
TRB-WS5850	5/8 X 5	10	
TRB-WS5860	5/8 X 6	10	
TRB-WS5870	5/8 X 7	10	
TRB-WS5884	5/8 X 8 1/2	10	
TRB-WS3442	3/4 X 4 1/4	10	
TRB-WS3446	3/4 X 4 3/4	10	
TRB-WS3454	3/4 X 5 1/2	10	
TRB-WS3462	3/4 X 6 1/4	10	
TRB-WS3470	3/4 X 7	10	
TRB-WS3484	3/4 X 8 1/2	10	
TRB-WS34100	3/4 X 10	10	
TRB-WS34120	3/4 X 12	10	
TRB-WS7860	7/8 X 6	5	
TRB-WS7880	7/8 X 8	5	
TRB-WS78100	7/8 X 10	5	
TRB-WS10060	1 X 6	5	
TRB-WS10090	1 X 9	5	
TRB-WS100120	1 X 12	5	
TRB-WS12590	1 1/4 X 9	5	
TRB-WS125120	1 1/4 X 12	5	

**RED HEAD STAINLESS STEEL WEDGE ANCHOR**

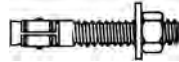

Line: 1393-00

PART NUMBER	SIZE	QTY/BX	LIST PRICE
TSB-WW1416	1/4 X 1 3/4	100	
TSB-WW1422	1/4 X 2 1/4	100	
TSB-WW1432	1/4 X 3 1/4	100	
TSB-WW3822	3/8 X 2 1/4	50	
TSB-WW3826	3/8 X 2 3/4	50	
TSB-WW3830	3/8 X 3	50	
TSB-WW3836	3/8 X 3 3/4	50	
TSB-WW3850	3/8 X 5	50	
TSB-WW1226	1/2 X 2 3/4	25	
TSB-WW1236	1/2 X 3 3/4	25	
TSB-WW1242	1/2 X 4 1/4	25	
TSB-WW1254	1/2 X 5 1/2	25	
TSB-WW1270	1/2 X 7	25	
TSB-WW5834	5/8 X 3 1/2	10	
TSB-WW5842	5/8 X 4 1/4	10	
TSB-WW5850	5/8 X 5	10	
TSB-WW5860	5/8 X 6	10	
TSB-WW5870	5/8 X 7	10	
TSBWW5884	5/8 X 8 1/2	10	
TSBWW3442	3/4 X 4 1/4	10	
TSB-WW3446	3/4 X 4 3/4	10	
TSB-WW3454	3/4 X 5 1/2	10	
TSBWW3462	3/4 X 6 1/4	10	
TSB-WW3470	3/4 X 7	10	
TSB-WW3484	3/4 X 8 1/2	10	
TSB-WW34100	3/4 X 10	10	
TSBWW10090	1 X 9	5	

**RED HEAD GALVANIZED WEDGE ANCHOR**



Line: 1393-01

PART NUMBER	SIZE	QTY/BX	LIST PRICE
AUWWS3826G	3/8 X 2 3/4	100	
AUWWS3830G	3/8 X 3	100	
AUWWS1226G	1/2 X 2 3/4	25	
AUWWS1236G	1/2 X 3 3/4	50	
AUWWS1242G	1/2 X 4 1/4	25	
AUWWS1254G	1/2 X 5 1/2	25	
AUWWS1270G	1/2 X 7	25	
AUWWS5834G	5/8 X 3 1/2	10	
AUWWS5860G	5/8 X 6	10	
AUWWS5870G	5/8 X 7	25	
AUWWS5884G	5/8 X 8 1/2	25	
AUWWS58120G	5/8 X 12	20	
AUWWS3446G	3/4 X 4 3/4	10	

(continued...)

**RED HEAD GALVANIZED WEDGE ANCHOR (cont.)**



Line: 1393-01

PART NUMBER	SIZE	QTY/BX	LIST PRICE
AUWWS3454G	3/4 X 5 1/2	10	
AUWWS3484G	3/4 X 8 1/2	10	
AUWWS34100G	3/4 X 10	10	
AUWWS7860G	7/8 X 6	5	
AUWWS78120G	7/8 X 12	5	
AUWWS10090G	1 X 9	5	
AUWWS12590G	1 1/4 X 9	5	

**RED HEAD 316 STAINLESS STEEL WEDGE ANCHOR**

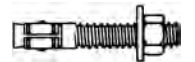

Line: 1393-02

PART NUMBER	SIZE	QTY/BX	LIST PRICE
AUXSWW1416	1/4 X 1 3/4	100	
AUXSWW1422	1/4 X 2 1/4	100	
AUXSWW1432	1/4 X 3 1/4	100	
AUXSWW3822	3/8 X 2 1/4	50	
AUXSWW3826	3/8 X 2 3/4	50	
AUXSWW3830	3/8 X 3	50	
AUXSWW3836	3/8 X 3 3/4	50	
AUXSWW3850	3/8 X 5	50	
AUXSWW1226	1/2 X 2 3/4	25	
AUXSWW1236	1/2 X 3 3/4	25	
AUXSWW1242	1/2 X 4 1/4	25	
AUXSWW1254	1/2 X 5 1/2	25	
AUXSWW5842	5/8 X 4 1/4	10	
AUXSWW5850	5/8 X 5	10	
AUXSWW5870	5/8 X 7	10	
AUXSWW5884	5/8 X 8 1/2	10	
AUXSWW3446	3/4 X 4 3/4	10	
AUXSWW3454	3/4 X 5 1/2	10	



**CALL - 1 (800) 723-2826**

**CALL: (800) 723-2826**

## RED HEAD STUD ANCHOR

Line: 1394-00



PART NUMBER	SIZE	QTY/BX	LIST PRICE
TTB-JS14C	1/4 X 1 3/4	100	
TTB-JS14H	1/4 X 2 1/4	100	
TTB-JS14M	1/4 X 3 1/4	100	
TTB-JS38C	3/8 X 2 1/4	50	
TTB-JS38H	3/8 X 3	50	
TTB-JS38M	3/8 X 3 3/4	50	
TTB-JS12C	1/2 X 2 3/4	25	
TTB-JS12H	1/2 X 4 1/4	25	
TTB-JS12M	1/2 X 5 1/4	25	
TTB-JS58H	5/8 X 5	10	
TTB-JS34C	3/4 X 4 1/4	10	
TTB-JS34H	3/4 X 6 1/4	10	
TTB-JS34M	3/4 X 8 1/2	10	

## STANDARD STEEL WEDGE ANCHOR

ASTM#164-55-RS

Line: 1394-10



PART NUMBER	SIZE	QTY/BX	LIST PRICE
BMD04056	1/4 X 1 3/4	100	
BMD04072	1/4 X 2 1/4	100	
BMD04096	1/4 X 3	100	
BMD04104	1/4 X 3 1/4	100	
BMD05068	5/16 X 2 1/8	100	
BMD06072	3/8 X 2 1/4	100	
BMD06088	3/8 X 2 3/4	100	
BMD06096	3/8 X 3	100	
BMD06112	3/8 X 3 1/2	100	
BMD06120	3/8 X 3 3/4	100	
BMD06120HDG	3/8 X 3 3/4 (HOT DIP GALVANIZED)	100	
BMD06160	3/8 X 5	50	
BMD06160HDG	3/8 X 5 (HOT DIP GALVANIZED)	50	
BMD06208	3/8 X 6 1/2	50	
BMD08088	1/2 X 2 3/4	50	
BMD08120	1/2 X 3 3/4	50	
BMD08120HDG	1/2 X 3 3/4 (HOT DIP GALVANIZED)	50	
BMD08136	1/2 X 4 1/4	25	
BMD08136HDG	1/2 X 4 1/4 (HOT DIP GALVANIZED)	25	
BMD08176	1/2 X 5 1/2	25	
BMD08176HDG	1/2 X 5 1/2 (HOT DIP GALVANIZED)	25	
BMD08224	1/2 X 7	25	
BMD08224HDG	1/2 X 7 (HOT DIP GALVANIZED)	25	
BMD08272	1/2 X 8 1/2	25	
BMD08272HDG	1/2 X 8 1/2 (HOT DIP GALVANIZED)	25	
BMD08320	1/2 X 10	25	

(continued...)

## STANDARD STEEL WEDGE ANCHOR (cont.)

ASTM#164-55-RS

Line: 1394-10



PART NUMBER	SIZE	QTY/BX	LIST PRICE
BMD08320HDG	1/2-13 X 10 (HOT DIP GALVANIZED)	25	
BMD08384	1/2 X 12	25	
BMD10112	5/8 X 3 1/2	25	
BMD10112HDG	5/8 X 3 1/2 (HOT DIP GALVANIZED)	25	
BMD10144	5/8 X 4 1/2	25	
BMD10160	5/8 X 5	25	
BMD10192	5/8 X 6	25	
BMD10192HDG	5/8 X 6 (HOT DIP GALVANIZED)	25	
BMD10224	5/8 X 7	25	
BMD10224HDG	5/8 X 7 (HOT DIP GALVANIZED)	25	
BMD10272	5/8 X 8 1/2	25	
BMD10272HDG	5/8 X 8 1/2 (HOT DIP GALVANIZED)	25	
BMD10320	5/8 X 10	20	
BMD10320HDG	5/8 X 10 (HOT DIP GALVANIZED)	20	
BMD10384	5/8 X 12	20	
BMD12136	3/4 X 4 1/4	20	
BMD12152	3/4 X 4 3/4	20	
BMD12176	3/4 X 5 1/2	20	
BMD12200	3/4 X 6 1/4	10	
BMD12224	3/4 X 7	10	
BMD12272	3/4 X 8 1/2	10	
BMD12272HDG	3/4 X 8 1/2 (HOT DIP GALVANIZED)	10	
BMD12320	3/4 X 10	10	
BMD12384	3/4 X 12	10	
BMD14192	7/8 X 6	5	
BMD14256	7/8 X 8	5	
BMD14320	7/8 X 10	5	
BMD14320HDG	7/8 X 10 (HOT DIP GALVANIZED)	5	
BMD14384	7/8 X 12	5	
BMD16192	1 X 6	5	
BMD16288	1 X 9	5	
BMD16384	1 X 12	5	
BMD20288	1 1/4 X 9	5	
BMD20384	1 1/4 X 12	5	

## STANDARD WEDGE ANCHOR

304 STAINLESS STEEL

Line: 1394-11



PART NUMBER	SIZE	QTY/BX	LIST PRICE
BTF04056	1/4 X 1 3/4	100	
BTF04072	1/4 X 2 1/4	100	
BTF04096	1/4 X 3	100	
BTF04104	1/4 X 3 1/4	100	
BTF06072	3/8 X 2 1/4	100	
BTF06088	3/8 X 2 3/4	100	
BTF06096	3/8 X 3	100	
BTF06112	3/8 X 3 1/2	100	
BTF06120	3/8 X 3 3/4	100	
BTF06160	3/8 X 5	50	
BTF06208	3/8 X 6 1/2	50	
BTF08088	1/2 X 2 3/4	50	
BTF08120	1/2 X 3 3/4	50	
BTF08136	1/2 X 4 1/4	25	
BTF08176	1/2 X 5 1/2	25	
BTF08224	1/2 X 7	25	
BTF08272	1/2 X 8 1/2	25	
BTF08320	1/2 X 10	25	
BTF08384	1/2 X 12	25	
BTF10112	5/8 X 3 1/2	25	
BTF10144	5/8 X 4 1/2	25	
BTF10160	5/8 X 5	25	
BTF10192	5/8 X 6	25	
BTF10224	5/8 X 7	25	
BTF10272	5/8 X 8 1/2	25	
BTF10320	5/8 X 10	20	
BTF10384	5/8 X 12	20	
BTF12136	3/4 X 4 1/4	20	
BTF12152	3/4 X 4 3/4	20	
BTF12176	3/4 X 5 1/2	20	
BTF12200	3/4 X 6 1/4	20	
BTF12224	3/4 X 7	10	
BTF12272	3/4 X 8 1/2	10	
BTF12320	3/4 X 10	10	
BTF12384	3/4 X 12	10	
BTF14192	7/8 X 6	5	
BTF14256	7/8 X 8	5	
BTF14320	7/8 X 10	5	
BTF14384	7/8 X 12	5	
BTF16192	1 X 6	5	
BTF16288	1 X 9	5	
BTF16384	1 X 12	5	
BTF20288	1 1/4 X 9	5	
BTF20384	1 1/4 X 12	5	

## RED HEAD - ACORN NUT SLEEVE ANCHOR

Line: 1395-00



PART NUMBER	SIZE	QTY/BX	LIST PRICE
TUB-AN1405	1/4 X 5/8	100	
TUB-AN1413	1/4 X 1 3/8	100	
TUB-AN1422	1/4 X 2 1/4	100	

## RED HEAD - FLAT HEAD SLEEVE ANCHOR

Line: 1396-00



PART NUMBER	SIZE	QTY/BX	LIST PRICE
TUB-FS1411	1/4 X 1 1/2	100	
TUB-FS1420	1/4 X 2 1/4	100	
TUB-FS1430	1/4 X 3 1/8	100	
TUB-FS1440	1/4 X 4	100	
TUB-FS1452	1/4 X 5 1/4	100	
TUB-FS3826	3/8 X 2 7/8	50	
TUB-FS3840	3/8 X 4	50	
TUB-FS3850	3/8 X 5	50	
TUB-FS3860	3/8 X 6	50	

## RED HEAD - HEX NUT SLEEVE ANCHOR

Line: 1397-00



PART NUMBER	SIZE	QTY/BX	LIST PRICE
TUB-HN1405	1/4 X 5/8	100	
TUB-HN1413	1/4 X 1 3/8	100	
TUB-HN1420	1/4 X 2 1/4	100	
TUB-HN1614	5/16 X 1 1/2	100	
TUB-HN1624	5/16 X 2 1/2	100	
TUB-HN3817	3/8 X 1 7/8	50	
TUB-HN3830	3/8 X 3	50	
TUB-HN1222	1/2 X 2 1/4	25	
TUB-HN1230	1/2 X 3	25	
TUB-HN1240	1/2 X 4	25	
TUB-HN5822	5/8 X 2 1/4	25	
TUB-HN5830	5/8 X 3	25	
TUB-HN5842	5/8 X 4 1/4	10	
TUB-HN5860	5/8 X 6	10	
TUB-HN3424	3/4 X 2 1/2	10	
TUB-HN3440	3/4 X 4	5	
TUB-HN3462	3/4 X 6 1/4	5	

## RED HEAD - ROUND HEAD SLEEVE ANCHOR



Line: 1399-00

PART NUMBER	SIZE	QTY/BX	LIST PRICE
TUB-RS1411	1/4 X 1 3/8	100	
TUB-RS1420	1/4 X 2	100	
TUB-RS1426	1/4 X 2 7/8	100	
TUB-RS3824	3/8 X 2 5/8	50	

## STANDARD ACORN NUT SLEEVE ANCHOR

ZINC PLATED



Line: 1399-01

PART NUMBER	SIZE	QTY/BX	LIST PRICE
BTG04020	1/4 X 5/8	100	
BTG04044	1/4 X 1 3/8	100	
BTG04072	1/4 X 2 1/4	100	

## STANDARD FLAT HEAD SLEEVE ANCHOR

ZINC PLATED

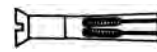

Line: 1399-02

PART NUMBER	SIZE	QTY/BX	LIST PRICE
BTH04044	1/4 X 1 3/8	100	
BTH04064	1/4 X 2	100	
BTH04096	1/4 X 3	100	
BTH04128	1/4 X 4	100	
BTH06088	3/8 X 2 3/4	50	
BTH06128	3/8 X 4	50	
BTH06160	3/8 X 5	50	
BTH06192	3/8 X 6	50	

## STANDARD HEX NUT SLEEVE ANCHOR



Line: 1399-03

PART NUMBER	SIZE	QTY/BX	LIST PRICE
BTJ04044	1/4 X 1 3/8	100	
BTJ05048	5/16 X 1 1/2	100	
BTJ05080	5/16 X 2 1/2	100	
BTJ06060	3/8 X 1 7/8	50	
BTJ06096	3/8 X 3	50	
BTJ06128	3/8 X 4	50	
BTJ08072	1/2 X 2 1/4	25	
BTJ08088	1/2 X 2 3/4	25	
BTJ08096	1/2 X 3	25	
BTJ08128	1/2 X 4	25	
BTJ08192	1/2 X 6	25	
BTJ10072	5/8 X 2 1/4	25	
BTJ10096	5/8 X 3	25	
BTJ10136	5/8 X 4 1/4	10	
BTJ10192	5/8 X 6	10	
BTJ12080	3/4 X 2 1/2	10	
BTJ12128	3/4 X 4	10	

## STANDARD HEX NUT SLEEVE ANCHOR (cont.)



Line: 1399-03

PART NUMBER	SIZE	QTY/BX	LIST PRICE
BTJ12136	3/4 X 4 1/4	5	
BTJ12176	3/4 X 5 1/2	5	
BTJ12200	3/4 X 6 1/4	10	
BTJ12256	3/4 X 8	5	

## STANDARD ROUND HEAD SLEEVE ANCHOR

ZINC PLATED



Line: 1399-04

PART NUMBER	SIZE	QTY/BX	LIST PRICE
BTK04040	1/4 X 1 1/4	100	
BTK04064	1/4 X 2	100	
BTK04088	1/4 X 2 3/4	100	
BTK05076	5/16 X 2 3/8	100	
BTK05108	5/16 X 3 3/8	100	
BTK06080	3/8 X 2 1/2	50	
BTK06120	3/8 X 3 3/4	50	

## EXPANSION CAULKING ANCHOR



Line: 1402-00

PART NUMBER	SIZE	QTY/BX	LIST PRICE
TVB-LD632	6/32	100	
TVB-LD832	8/32	100	
TVB-LD102	10/24	100	
TVB-LD122	12/24	100	
TVB-LD140	1/4-20	100	
TVB-LD156	5/16-18	50	
TVB-LD320	3/8-16	50	
TVB-LD120	1/2-13	25	
TVB-LD580	5/8-11	25	
TVB-LD340	3/4-10	25	
TVB-LD78X	7/8-9	10	

## HAMMER DRIVE ANCHOR

STEEL PIN

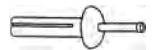

Line: 1402-01

PART NUMBER	SIZE	QTY/BX	LIST PRICE
ART03028	3/16 X 7/8	100	
ART04024	1/4 X 3/4	100	
ART04032	1/4 X 1	100	
ART04040	1/4 X 1 1/4	100	
ART04048	1/4 X 1 1/2	100	
ART04064	1/4 X 2	100	

(continued...)

**HAMMER DRIVE ANCHOR**

STAINLESS STEEL PIN

Line: 1402-02

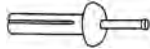

PART NUMBER	SIZE	QTY/BX	LIST PRICE
ARV03028	3/16 X 7/8	100	
ARV04032	1/4 X 1	100	
ARV04040	1/4 X 1 1/4	100	
ARV04048	1/4 X 1 1/2	100	
ARV04064	1/4 X 2	100	

**CAULKING ANCHOR SETTING TOOL**

Line: 1403-00



PART NUMBER	SIZE	QTY/BX	LIST PRICE
TWB-CT632	#6	1	
TWB-CT832	#8	1	
TWB-CT102	#10	1	
TWB-CT122	#12	1	
TWB-CT140	1/4	1	
TWB-CT516	5/16	1	
TWB-CT380	3/8	1	
TWB-CT120	1/2	1	
TWB-CT580	5/8	1	
TWB-CT340	3/4	1	

**MASONRY PIN GRIP DRIVE RIVET**

Line: 1404-00

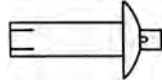

PART NUMBER	SIZE	QTY/BX	LIST PRICE
TXB03024	3/16 X 3/4	100	
TXB04032	1/4 X 1	100	
TXB04040	1/4 X 1 1/4	100	
TXB04048	1/4 X 1 1/2	100	

**RAWL DRIVE ROUND HEAD- 1PC. DRIVE ANCHOR**

Line: 1406-00



PART NUMBER	SIZE	QTY/BX	LIST PRICE
UCB03032	3/16 X 1	100	
UCB04048	1/4 X 1 1/2	100	
UCB04080	1/4 X 2 1/2	100	
UCB06064	3/8 X 2	25	
UCB06080	3/8 X 2 1/2	25	
UCB08088	1/2 X 2 3/4	25	
UCB08096	1/2 X 3	25	

**RAWL DRIVES COUNTERSUNK**

1 PIECE DRIVE ANCHOR

Line: 1408-00



PART NUMBER	SIZE	QTY/BX	LIST PRICE
UEB03048	3/16 X 1 1/2	100	
UEB03064	3/16 X 2	100	
UEB03080	3/16 X 2 1/2	100	
UEB04048	1/4 X 1 1/2	100	
UEB04064	1/4 X 2	100	
UEB04080	1/4 X 2 1/2	100	
UEB04096	1/4 X 3	100	
UEB04112	1/4 X 3 1/2	100	
UEB04128	1/4 X 4	100	
UEB06080	3/8 X 2 1/2	25	

**SELF DRILL ANCHOR**

SNAP OFF TYPE

Line: 1409-00



PART NUMBER	SIZE	QTY/BX	LIST PRICE
SXB-S14	1/4	100	
SXB-S16	5/16	100	
SXB-S38	3/8	50	
SXB-S12	1/2	50	
SXB-S52	5/8	25	
SXB-S34	3/4	25	
SXB-S78X	7/8	25	

**1/4 HEADED DRIVE PIN**

Line: 1409-05



PART NUMBER	SIZE	QTY/BX	LIST PRICE
ANY04016	1/4 X 1/2	100	
ANY04024	1/4 X 3/4	100	
ANY04032	1/4 X 1	100	
ANY04040	1/4 X 1 1/4	100	
ANY04048	1/4 X 1 1/2	100	
ANY04064	1/4 X 2	100	

**1/4 HEADED PIN TOOL**

Line: 1409-06



PART NUMBER	SIZE	QTY/BX	LIST PRICE
ANZ01	SETTING TOOL	1	

# WEJ-IT STEEL CONCRETE ANCHORS

Line: 1410-01



PART NUMBER	SIZE	QTY/BX	LIST PRICE
JRR1413	1/4 X 1 3/4	100	
JRR1423	1/4 X 2 3/4	100	
JRR1430	1/4 X 3	100	
JRR5620	5/16 X 2	100	
JRR5630	5/16 X 3	100	
JRR3812	3/8 X 1 1/2	100	
JRR3820	3/8 X 2	100	
JRR3823	3/8 X 2 3/4	100	
JRR3832	3/8 X 3 1/2	50	
JRR3850	3/8 X 5	50	
JRR3860	3/8 X 6	50	
JRR1223	1/2 X 2 3/4	50	
JRR1232	1/2 X 3 1/2	50	
JRR1250	1/2 X 5	25	
JRR1260	1/2 X 6	25	
JRR1270	1/2 X 7	25	
JRR5832	5/8 X 3 1/2	25	
JRR5842	5/8 X 4 1/2	25	
JRR5850	5/8 X 5	20	
JRR5860	5/8 X 6	15	
JRR5870	5/8 X 7	15	
JRR3440	3/4 X 4	18	
JRR3450	3/4 X 5	12	
JRR3460	3/4 X 6	12	
JRR3470	3/4 X 7	10	
JRR3482	3/4 X 8 1/2	10	
JRR3410	3/4 X 10	10	
JRR7880	7/8 X 8	10	
JRR7810	7/8 X 10	10	
JRR7812	7/8 X 12	5	
JRR1080	1 X 8	10	
JRR1010	1 X 10	5	
JRR1012	1 X 12	5	

# TAPCON MASONRY SLTD HEX WASHER HD SC

WITH DRILL

Line: 1411-00



PART NUMBER	SIZE	QTY/BX	LIST PRICE
AMDLE300	3/16 X 1 1/4 (LT300DR)	100	
AMDLE310	3/16 X 1 3/4 (LT300DR)	100	
AMDLE320	3/16 X 2 1/4 (LT310DR)	100	
AMDLE330	3/16 X 2 3/4 (LT310DR)	100	
AMDLE340	3/16 X 3 1/4 (LT320DR)	100	
AMDLE350	3/16 X 3 3/4 (LT320DR)	100	
AMDLE360	3/16 X 4 (LT320 DRILL)	100	
AMDLE405	1/4 X 1 1/4 (LT405DR)	100	
AMDLE415	1/4 X 1 3/4 (LT405DR)	100	
AMDLE425	1/4 X 2 1/4 (LT415DR)	100	
AMDLE435	1/4 X 2 3/4 (LT415DR)	100	
AMDLE445	1/4 X 3 1/4 (LT425DR)	100	
AMDLE455	1/4 X 3 3/4 (LT425DR)	100	
AMDLE465	1/4 X 4 (LT425 DRILL)	100	
AMDLE475	1/4 X 5	100	
AMDLE485	1/4 X 6	100	
AMDLE475	5/16X2 (LH475)	50	
AMDLE485	5/16 X 3 1/4 (LH496)	50	
AMDLE495	5/16 X 4 (LH495)	50	

# TAPCON MASONRY PHILLIPS FLAT SCREW

WITH DRILL

Line: 1411-01



PART NUMBER	SIZE	QTY/BX	LIST PRICE
AMELF305	3/16 X 1 1/4 (LT300DR)	100	
AMELF315	3/16 X 1 3/4 (LT300DR)	100	
AMELF325	3/16 X 2 1/4 (LT310DR)	100	
AMELF335	3/16 X 2 3/4 (LT310DR)	100	
AMELF345	3/16 X 3 1/4 (LT320DR)	100	
AMELF355	3/16 X 3 3/4 (LT320DR)	100	
AMELF365	3/16 X 4 (LT 320 DRILL)	100	
AMELF400	1/4 X 1 1/4 (LT405DR)	100	
AMELF410	1/4 X 1 3/4 (LT405DR)	100	
AMELF420	1/4 X 2 1/4 (LT415DR)	100	
AMELF430	1/4 X 2 3/4 (LT415DR)	100	
AMELF440	1/4 X 3 1/4 (LT425DR)	100	
AMELF450	1/4 X 3 3/4 (LT425DR)	100	
AMELF460	1/4 X 4 (LT425 DRILL)	100	
AMELF470	1/4 X 5 (LT435 DRILL)	100	
AMELF480	1/4 X 6 (LT445 DRILL)	100	
AMELH910	5/16 X 3	50	
AMELH920	5/16 X 4	50	
AMELH930	5/16 X 5	50	
AMELH940	5/16 X 6	50	



## TAPCON CONDRIVE INSTALLATION TOOL KIT

AND INSTALLATION KITS

Line: 1411-02



PART NUMBER	SIZE	QTY/BX	LIST PRICE
AMFLP100	1000 2 STEP ALL SIZE	1	
AMFLP200	2000 1STEP 2 3/4MAX	1	
AMFLP250	ECONO 2 STEP 4MAX	1	
AMFLX300	ELECTRICIANS KIT	1	
AMFLX310	GENERAL CONTRACTORS KIT	1	
AMFL516	5/16 DIAMETER DRIVE TOOL	1	

## TAPCON MASONRY INSTALLATION DRILLS

Line: 1411-03



PART NUMBER	SIZE	QTY/BX	LIST PRICE
AMGLT300	5/32 X 3 1/2	1	
AMGLT310	5/32 X 4 1/2	1	
AMGLT320	5/32 X 5 1/2	1	
AMGLT535	5/32 X 5 - SDS SHANK	1	
AMGLT555	5/32 X 7 - SDS SHANK	1	
AMGLT405	3/16 X 3 1/2	1	
AMGLT415	3/16 X 4 1/2	1	
AMGLT425	3/16 X 5 1/2	1	
AMGLT435	3/16 X 6 1/2	1	
AMGLT445	3/16 X 7 1/2	1	
AMGLT630	3/16 X 5 - SDS SHANK	1	
AMGLT650	3/16 X 7 - SDS SHANK	1	
AMGLT460	1/4 X 4 1/2 TANGED	1	
AMGLT465	1/4 X 5 1/2 TANGED	1	
AMGLT475	1/4 X 7 1/2 TANGED	1	
AMGLT680	1/4 X 7 - SDS SHANK	1	
AMGLT690	1/4 X 9 1/2 - SDS SHANK	1	

## TAPCON 1000 SERIES INSTALLATION TOOL PARTS

Line: 1411-04

PART NUMBER	SIZE	QTY/BX	LIST PRICE
AMHLY100	DRILL ADAPTER	1	
AMHLY110	DRIVE SLEEVE ASSEMBLY	1	
AMHLY160	PHILLIPS SOCKET	1	
AMHLY170	5-6 DRIVE ASSEMBLY	1	
AMHLY130	1/4 SOCKET FOR 3/16 DIAMETER	1	
AMHLY120	5/16 SOCKET FOR 1/4 DIAMETER	1	

## TAPCON 2000 SERIES INSTALLATION TOOL PARTS

Line: 1411-05

PART NUMBER	SIZE	QTY/BX	LIST PRICE
AMJLY180	TL BDY & DRV ASSEMBLY	1	
AMJLY190	1/4 SOCKET FOR 3/16 DIAMETER	1	
AMJLY200	5/16 SOCKET FOR 1/4 DIAMETER	1	

## HEX MASONRY HARD SCREW ANCHORS

NO DRILL - GLOBAL

Line: 1411-06



PART NUMBER	SIZE	QTY/BX	LIST PRICE
CGPLP100	2-STEP ECON DRV TOOL	1	
CGP03040SHW	3/16 X 1 1/4 S/HXW	100	
CGP03056SHW	3/16 X 1 3/4 S/HXW	100	
CGP03072SHW	3/16 X 2 1/4 S/HXW	100	
CGP03088SHW	3/16 X 2 3/4 S/HXW	100	
CGP03104SHW	3/16 X 3 1/4 S/HXW	100	
CGP03120SHW	3/16 X 3 3/4 S/HXW	100	
CGP03128SHW	3/16 X 4 S/HXW	100	
CGP04040SHW	1/4 X 1 1/4 S/HXW	100	
CGP04056SHW	1/4 X 1 3/4 S/HXW	100	
CGP04072SHW	1/4 X 2 1/4 S/HXW	100	
CGP04088SHW	1/4 X 2 3/4 S/HXW	100	
CGP04104SHW	1/4 X 3 1/4 S/HXW	100	
CGP04120SHW	1/4 X 3 3/4 S/HXW	100	
CGP04128SHW	1/4 X 4 S/HXW	100	
CGP04160SHW	1/4 X 5 S/HXW	100	
CGP04192SHW	1/4 X 6 S/HXW	100	

## PHIL FLAT HEAD MASONRY SCREW ANCHORS

NO DRILL - GLOBAL

Line: 1411-07



PART NUMBER	SIZE	QTY/BX	LIST PRICE
CGP03040FT	3/16 X 1 1/4 PH/FLAT	100	
CGP03056FT	3/16 X 1 3/4 PH/FLAT	100	
CGP03072FT	3/16 X 2 1/4 PH/FLAT	100	
CGP03088FT	3/16 X 2 3/4 PH/FLAT	100	
CGP03104FT	3/16 X 3 1/4 PH/FLT	100	
CGP03120FT	3/16 X 3 3/4 PH/FLT	100	
CGP03128FT	3/16 X 4 PH/FLAT	100	
CGP04040FT	1/4 X 1 1/4 PH/FLAT	100	
CGP04056FT	1/4 X 1 3/4 PH/FLAT	100	
CGP04072FT	1/4 X 2 1/4 PH/FLAT	100	
CGP04088FT	1/4 X 2 3/4 PH/FLAT	100	
CGP04104FT	1/4 X 3 1/4 PH/FLAT	100	
CGP04120FT	1/4 X 3 3/4 PH/FLAT	100	
CGP04128FT	1/4 X 4 PH/FLAT	100	
CGP04160FT	1/4 X 5 PH/FLAT	100	
CGP04192FT	1/4 X 6 PH/FLAT	100	

## HANGER MATE THREADED ROD

ANCHORING SYSTEM

Line: 1411-20



PART NUMBER	SIZE	QTY/BX	LIST PRICE
BHTZE100	1/4-20 DRL TO 1/4 STL	50	
BHTZE140	1/4-20 MAS/WOOD ANCH	50	
BHTZE120	3/8-16 DRL TO 1/4 STL	50	
BHTZE160	3/8-16 MAS/WOOD ANCH	50	

## TOGGLE BOLTS WITH SPRING WING NUTS

W/ ROUND HEADS OR FLAT HEADS

Line: 1412-00



PART NUMBER	SIZE	QTY/BX	LIST PRICE
UAB66064	1/8 X 2 ROUND HEAD	50	
UAB66064FH	1/8 X 2 FLAT HEAD	50	
UAB66096	1/8 X 3 ROUND HEAD	50	
UAB66096FH	1/8 X 3 FLAT HEAD	50	
UAB66128	1/8 X 4 ROUND HEAD	50	
UAB66128FH	1/8 X 4 FLAT HEAD	50	
UAB03064	3/16 X 2 ROUND HEAD	50	
UAB03064FH	3/16 X 2 FLAT HEAD	50	
UAB03096	3/16 X 3 ROUND HEAD	50	
UAB03096FH	3/16 X 3 FLAT HEAD	50	
UAB03128	3/16 X 4 ROUND HEAD	50	
UAB03128FH	3/16 X 4 FLAT HEAD	50	
UAB03160	3/16 X 5 ROUND HEAD	50	
UAB03160FH	3/16 X 5 FLAT HEAD	50	
UAB03192	3/16 X 6 ROUND HEAD	50	
UAB03192FHX	3/16 X 6 ROUND HEAD	50	
UAB04064	1/4 X 2 ROUND HEAD	50	
UAB04096	1/4 X 3 ROUND HEAD	50	
UAB04096FH	1/4 X 3 FLAT HEAD	50	
UAB04128	1/4 X 4 ROUND HEAD	50	
UAB04128FH	1/4 X 4 FLAT HEAD	50	
UAB04160	1/4 X 5 ROUND HEAD	50	
UAB04160FH	1/4 X 5 FLAT HEAD	50	
UAB04192	1/4 X 6 ROUND HEAD	50	
UAB04192FH	1/4 X 6 FLAT HEAD	50	
UAB05096	5/16 X 3 ROUND HEAD	25	
UAB05096FH	5/16 X 3 FLAT HEAD	25	
UAB05128	5/16 X 4 ROUND HEAD	25	
UAB05128FH	5/16 X 4 FLAT HEAD	25	
UAB05160	5/16 X 5 ROUND HEAD	25	
UAB05160FH	5/16 X 5 FLAT HEAD	25	
UAB05192	5/16 X 6 ROUND HEAD	25	
UAB05192FHX	5/16 X 6 FLAT HEAD	25	
UAB06096	3/8 X 3 ROUND HEAD	25	
UAB06096FH	3/8 X 3 FLAT HEAD	25	
UAB06128	3/8 X 4 ROUND HEAD	25	

(continued...)

## TOGGLE BOLTS WITH SPRING WING NUTS (cont.)



Line: 1412-00

PART NUMBER	SIZE	QTY/BX	LIST PRICE
UAB06128FH	3/8 X 4 FLAT HEAD	25	
UAB06160	3/8 X 5 ROUND HEAD	25	
UAB06160FH	3/8 X 5 FLAT HEAD	25	
UAB06192	3/8 X 6 ROUND HEAD	25	
UAB06192FHX	3/8 X 6 FLAT HEAD	25	
UAB08128	1/2 X 4 ROUND HEAD	25	
UAB08160	1/2 X 5 ROUND HEAD	25	
UAB08192	1/2 X 6 ROUND HEAD	25	

## MUSHROOM HEAD TOGGLE BOLTS

WITH SPRING WIRE NUT

Line: 1412-05



PART NUMBER	SIZE	QTY/BX	LIST PRICE
UAC66064	1/8 X 2	50	
UAC66096	1/8 X 3	50	
UAC66096C	1/8 X 3	100	
UAC66128	1/8 X 4	50	
UAC03064	3/16 X 2	50	
UAC03096	3/16 X 3	50	
UAC03128	3/16 X 4	50	
UAC03160	3/16 X 5	50	
UAC03192	3/16 X 6	50	
UAC04096	1/4 X 3	50	
UAC04128	1/4 X 4	50	
UAC04192	1/4 X 6	50	

## SPRING TOGGLE WING NUTS

Line: 1413-00



PART NUMBER	SIZE	QTY/BX	LIST PRICE
DJD02	6/32	50	
DJD02C	6/32	100	
DJD88	8/32	50	
DJD03	10/24	50	
DJD03C	10/24	100	
DJD04	1/4-20	50	
DJD04C	1/4-20	100	
DJD05	5/16-18	50	
DJD06	3/8-16	25	
DJD06C	3/8-16	100	
DJD06Q50	3/8-16	50	
DJD08	1/2-13	25	

**HOLLOW WALL DRIVE TYPE MOLLY ANCHOR**

Line: 1414-00



PART NUMBER	SIZE	QTY/BX	LIST PRICE
UBB-WD18DL	1/8 - REGULAR LONG	100	
UBB-WD18DS	1/8 - REGULAR SHORT	100	
UBB-WD18DXS	1/8 EXTRA SHORT	100	

**HOLLOW WALL MOLLY ANCHOR**

Line: 1415-00



PART NUMBER	SIZE	QTY/BX	LIST PRICE
UBB-WA18XS	1/8 - X SHORT	100	
UBB-WA18S	1/8 - REGULAR SHORT	100	
UBB-WA18L	1/8 - REGULAR LONG	100	
UBB-WA18XL	1/8 - X LONG	100	
UBB-WA36S	3/16 - REGULAR SHORT	50	
UBB-WA36L	3/16 - REGULAR LONG	50	
UBB-WA36XL	3/16 - X LONG	50	
UBB-WA14S	1/4 - REGULAR SHORT	50	
UBB-WA14L	1/4 - REGULAR LONG	50	
UBB-WA14XL	1/4 - X LONG	50	

**SANKO HOLLOW WALL ANCHOR**

Line: 1415-05



PART NUMBER	SIZE	QTY/BX	LIST PRICE
AYD2045	1/4 X 1 3/4	25	
AYD2064	1/4 X 2 1/2	25	
AYD2083	1/4 X 3 1/4	25	
AYD2564	5/16 X 2 1/2	25	
AYD2583	5/16 X 3 1/4	25	
AYD2595	5/16 X 3 3/4	25	
AYD3083	3/8 X 3 1/4	25	
AYD3095	3/8 X 3 3/4	25	
AYD3115	3/8 X 4 1/2	25	

**EASY TOGGLER HOLLOW WALL ANCHOR**

TOGGLER BRAND

Line: 1415-06



PART NUMBER	SIZE	QTY/BX	LIST PRICE
BJW03BA	10/24 3/8 TO 2 1/2	100	
BJW04BB	1/4-20 3/8 TO 2 1/2,00100	100	
BJW04BBL	1/4-20 2 TO 9 1/2 WALL	50	
BJW06BC	3/8-16 3/8 TO 2 1/2,00025	25	
BJW08BD	1/2-13 3/8 TO 2 1/2,00025	25	

**STANDARD KAP TOGGLES LESS SCREW**

Line: 1415-08



PART NUMBER	SIZE	QTY/BX	LIST PRICE
CGW02	1/8	100	
CGW03	3/16	50	
CGW04	1/4	50	

**22 CALIBER POWER LOADS**

Line: 1416-00



PART NUMBER	SIZE	QTY/BX	LIST PRICE
UFB22A	GRAY	100	
UFB22B	BROWN	100	
UFB22G	GREEN	100	
UFB22Y	YELLOW	100	

**27 CALIBER POWER LOADS**

Line: 1416-05



PART NUMBER	SIZE	QTY/BX	LIST PRICE
UFB27G	GREEN	100	
UFB27R	RED	100	
UFB27Y	YELLOW	100	

**1/4 POWER PINS**

Line: 1417-00

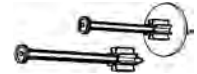

PART NUMBER	SIZE	QTY/BX	LIST PRICE
UGB04016	1/4 X 1 1/2	100	
UGB04024	1/4 X 3/4	100	
UGB04024W	1/4 X 3/4 (WITH WASHER)	100	
UGB04032	1/4 X 1	100	
UGB04032W	1/4 X 1 (WITH WASHER)	100	
UGB04040	1/4 X 1 1/4	100	
UGB04040W	1/4 X 1 1/4 (WITH WASHER)	100	
UGB04048	1/4 X 1 1/2	100	
UGB04048W	1/4 X 1 1/2 (WITH WASHER)	100	
UGB04064	1/4 X 2	100	
UGB04064W	1/4 X 2 (WITH WASHER)	100	
UGB04080	1/4 X 2 1/2	100	
UGB04080W	1/4 X 2 1/2 (WITH WASHER)	100	
UGB04096	1/4 X 3	100	



**CALL - 1 (800) 723-2826**

**CALL: (800) 723-2826**

## DROP FORGED EYE TO EYE TURNBUCKLES

GALVANIZED

Line: 1421-00



PART NUMBER	SIZE	QTY/BX	LIST PRICE
ULB16384	1 X 12	1	
ULB04128	1/4 X 4	1	
ULB05144	5/16 X 4 1/2	1	
ULB06192	3/8 X 6	1	
ULB08192	1/2 X 6	1	
ULB08288	1/2 X 9	1	
ULB08384	1/2 X 12	1	
ULB10192	5/8 X 6	1	
ULB10288	5/8 X 9	1	
ULB10384	5/8 X 12	1	
ULB12192	3/4 X 6	1	
ULB12288	3/4 X 9	1	
ULB12384	3/4 X 12	1	
ULB14384	7/8 X 12	1	
ULB14384HE	7/8 X 12 (HK X EYE)	1	
ULB14576	7/8 X 18	1	

## MIDGET TURNBUCKLES

CAST ALUMINUM

Line: 1422-00



PART NUMBER	SIZE	QTY/BX	LIST PRICE
UMB008	#4	10	
UMB010	#5	10	
UMB012	#6	10	

## TURNUED LAG SCREW EYE BOLTS

ZINC

Line: 1423-00



PART NUMBER	SIZE	QTY/BX	LIST PRICE
UNB04088	1/4 X 2 3/4	10	
UNB04112	1/4 X 3 1/2	10	
UNB04128	1/4 X 4	10	
UNB05080	5/16 X 2 1/2	10	
UNB05088	5/16 X 2 3/4	10	
UNB05152	5/16 X 4 3/4	10	
UNB06096	3/8 X 3	10	
UNB06192	3/8 X 6	10	
UNB08112	1/2 X 3 1/2	10	

## SCREW HOOK W/LAG SCREW THREAD

Line: 1423-05



PART NUMBER	SIZE	QTY/BX	LIST PRICE
ANX135064	.135 X 2	50	
ANX156048	.156 X 1 1/2	50	
ANX192102	.192 X 3 3/8	50	
ANX192108	.192 X 3 3/8	50	
ANX244132	.244 X 4 1/8	25	

## U-BOLTS WITH PLATES

ZINC

Line: 1424-00



PART NUMBER	SIZE	QTY/BX	LIST PRICE
UPB1	1/4 X 9/16 X 1 1/4	10	
UPB2	1/4 X 3/4 X 1 1/4	10	
UPB3	1/4 X 3/4 X 2 1/4	10	
UPB4	1/4 X 1 X 1 3/4	10	
UPB4L	1/4 X 1 X 2 3/4	10	
UPB5	1/4 X 1 1/8 X 2	10	
UPB5L	1/4 X 1 1/8 X 3 1/8	10	
UPB6	1/4 X 1 1/4 X 2 1/4	10	
UPB7	1/4 X 1 1/2 X 2 3/4	10	
UPB8	1/4 X 1 3/4 X 3	10	
UPB9	1/4 X 2 X 3 1/4	10	
UPB10	5/16 X 1 X 2 3/16	10	
UPB101	5/16 X 1 1/8 X 2 3/16	10	
UPB11	5/16 X 1 3/8 X 2 3/16	10	
UPB11L	5/16 X 1 3/8 X 3 5/8	10	
UPB12	5/16 X 1 1/2 X 2 3/16	10	
UPB13	5/16 X 1 3/4 X 2 11/16	10	
UPB13L	5/16 X 1 3/4 X 4 1/2	10	
UPB14	5/16 X 2 X 2 11/16	10	
UPB14L	5/16 X 2 X 4 3/4	10	
UPB15	5/16 X 2 1/2 X 3 3/16	10	
UPB15L	5/16 X 2 1/2 X 5 5/8	10	
UPB16	5/16 X 3 X 3 11/16	10	
UPB17	3/8 X 1 X 2 1/4	10	
UPB18	3/8 X 1 1/4 X 2 1/4	10	
UPB19	3/8 X 1 1/2 X 2 1/2	10	
UPB20	3/8 X 1 3/4 X 2 3/4	10	
UPB21	3/8 X 2 X 2 5/8	10	
UPB22	3/8 X 2 1/2 X 3 1/8	10	
UPB23	3/8 X 3 X 3 5/8	10	
UPB23L	3/8 X 3 X 6 5/8	10	
UPB24	3/8 X 3 1/2 X 4 1/8	10	
UPB25	1/2 X 3 X 4 1/2	10	
UPB26	1/2 X 3 1/2 X 5	10	
UPB26L	1/2 X 3 1/2 X 8 1/2	10	
UPB27	1/2 X 4 X 5 1/2	10	
UPB28	1/2 X 4 1/2 X 6	10	

### U-BOLTS NO PLATES

ZINC

Line: 1425-00



PART NUMBER	SIZE	QTY/BX	LIST PRICE
URB01	1/4 X 9/16 X 1 1/4	10	
URB02	1/4 X 3/4 X 1 1/4	10	
URB02LX	#02L 1/4 STK X 3/8	10	
URB03	1/4 X 3/4 X 2 1/4	10	
URB04	1/4 X 1 X 1 3/4	10	
URB04L	1/4 X 1 X 2 3/4	10	
URB05	1/4 X 1 1/8 X 2	10	
URB05L	1/4 X 1 1/8 X 3 1/8	10	
URB06	1/4 X 1 1/4 X 2 1/4	10	
URB06L	1/4 X 1 1/2 X 3 1/2	10	
URB07	1/4 X 1 1/2 X 2 3/4	10	
URB08	1/4 X 1 3/4 X 3	10	
URB09	1/4 X 2 X 3 1/4	10	
URB010	5/16 X 1 X 2 3/16	10	
URB0101	5/16 X 1 1/8 X 2 3/16	10	
URB011	5/16 X 1 3/8 X 2 3/16	10	
URB011L	5/16 X 1 3/8 X 3 5/8	10	
URB012	5/16 X 1 1/2 X 2 3/16	10	
URB013	5/16 X 1 3/4 X 2 11/16	10	
URB013L	5/16 X 1 3/4 X 4 1/2	10	
URB014	5/16 X 2 X 2 11/16	10	
URB014L	5/16 X 2 X 4 3/4	10	
URB015	5/16 X 2 1/2 X 3 3/16	10	
URB015L	5/16 X 2 1/2 X 5 5/8	10	
URB016	5/16 X 3 X 3 11/16	10	
URBLT-3	3/8 X 1 3/8 X 3 7/16	10	
URBLT-5	3/8 X 2 X 4(2.5THD)	10	
URB017	3/8 X 1 X 2 1/4	10	
URB018	3/8 X 1 1/4 X 2 1/4	10	
URB019	3/8 X 1 1/2 X 2 1/2	10	
URB020	3/8 X 1 3/4 X 2 3/4	10	
URB021	3/8 X 2 X 2 5/8	10	
URB022	3/8 X 2 1/2 X 3 1/8	10	
URB023	3/8 X 3 X 3 5/8	10	
URB023L	3/8 X 3 X 6 5/8	10	
URB024	3/8 X 3 1/2 X 4 1/8	10	
URBLT-7	1/2 X 3 X 5 1/4(3T)	10	
URB025	1/2 X 3 X 4 1/2	10	
URB026	1/2 X 3 1/2 X 5	10	
URB026L	1/2 X 3 1/2 X 8 1/2	10	
URB027	1/2 X 4 X 5 1/2	10	
URB028	1/2 X 4 1/2 X 6	10	
URB029	1/2 X 5 5/8 X 7 1/4	1	
URB030	1/2 X 6 3/4 X 8 3/8	1	

(continued...)

### U-BOLTS NO PLATES (cont.)

ZINC

Line: 1425-00



PART NUMBER	SIZE	QTY/BX	LIST PRICE
URB031	1/2 X 8 3/4 X 10 3/8	1	
URB032	3/4 X 10 7/8 X 13 3/4	1	
URB033	7/8 X 12 7/8 X 16	1	
URB034	7/8 X 14 1/8 X 18	1	
URB035	7/8 X 16 1/8 X 19 1/4	1	
URB14176X	7/8 STK X 5 1/2 ID	1	

### U-BOLTS WITH NUTS

HOT DIPPED GALVANIZED

Line: 1426-01



PART NUMBER	SIZE	QTY/BX	LIST PRICE
BJT050	1/2 PIPE 1/4-20	1	
BJT075	3/4 PIPE SIZE 1/4-20	1	
BJT10	10 PIPE SIZE 3/4-10	1	
BJT12	12 PIPE SIZE 7/8-9	1	
BJT14	14 PIPE 7/8-9	1	
BJT150	1 1/2 PIPE SIZE 3/8	1	
BJT16	16 PIPE SIZE 7/8-9	1	
BJT18	18 PIPE 1-8	1	
BJT1	1 PIPE SIZE 1/4-20	1	
BJT125	1 1/4 PIPE 3/8-16	1	
BJT2	2 PIPE SIZE 3/8-16	1	
BJT250	2 1/2 PIPE 1/2-13	1	
BJT3	3 PIPE SIZE 1/2-13	1	
BJT350	3 1/2 PIPE 1/2-13	1	
BJT4	4 PIPE SIZE 1/2-13	1	
BJT5	5 PIPE 1/2-13	1	
BJT6	6 PIPE SIZE 1/2-13	1	
BJT8	8 PIPE SIZE 5/8-11	1	

### U-BOLTS WITH NUTS

STAINLESS STEEL

Line: 1426-02



PART NUMBER	SIZE	QTY/BX	LIST PRICE
BJZ1304	1 PIPE 304 1/4-20	1	
BJZ125304	1 1/4 PIPE 304 1/4-20	1	
BJZ150304	1 1/2 PIPE 304 1/4-20	1	
BJZ2304	2 PIPE 304 3/8-16	1	
BJZ3304	3 PIPE 304 1/2-13	1	
BJZ4304	4 PIPE 304 1/2-13	1	
BJZ6304	6 PIPE 304 1/2-13	1	
BJZ8304	8 PIPE 304 1/2-13	1	

## U-BOLTS SQUARE BEND

STEEL PLATED

Line: 1426-03

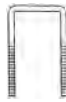

PART NUMBER	SIZE	QTY/BX	LIST PRICE
BKDSB1	2W X 3L 3/8-16	1	
BKDSB1G	2W X 3L GALV 3/8-16	1	
BKDSB2	2W X 5L 3/8-16	1	
BKDSB2G	2W X 5L GALV 3/8-16	1	
BKDSB3	2W X 7L 3/8-16	1	
BKDSB3G	2W X 7L GALV 3/8-16	1	
BKDSB4	4W X 3L 3/8-16	1	
BKDSB4G	4W X 3L GALV 3/8-16	1	
BKDSB5	4W X 5L 3/8-16	1	
BKDSB5G	4W X 5L GALV 3/8-16	1	
BKDSB6	4W X 7L 3/8-16	1	
BKDSB6G	4W X 7L GALV 3/8-16	1	
BKDSB7	6W X 5L 3/8-16	1	
BKDSB7G	6W X 5L GALV 3/8-16	1	
BKDSB8	6W X 7L 3/8-16	1	
BKDSB8G	6W X 7L GALV 3/8-16	1	
BKDSB9	6W X 9L 3/8-16	1	
BKDSB9G	6W X 9L GALV 3/8-16	1	

## TURNED EYE BOLTS WITH NUTS

ZINC

Line: 1427-00



PART NUMBER	SIZE	QTY/BX	LIST PRICE
USB-A1	1/8 X 3/4	10	
USB-B1	5/32 X 1 1/8	10	
USB-C1	3/16 X 1	10	
USB-C2	3/16 X 1 3/8	10	
USB-C3	3/16 X 2	10	
USB-C4	3/16 X 3	10	
USB-D1	7/32 X 1 1/2	10	
USB-E1	1/4 X 1	10	
USB-E2	1/4 X 1 1/2	10	
USB-E2A	1/4 X 1 7/8	10	
USB-E3	1/4 X 2	10	
USB-E4	1/4 X 2 1/2	10	
USB-E5	1/4 X 3	10	
USB-E6	1/4 X 3 1/2	10	
USB-E7	1/4 X 4	10	
USB-E8	1/4 X 5	10	
USB-E9	1/4 X 6	10	
USB-F1	5/16 X 1	10	
USB-F2	5/16 X 2	10	
USB-F2A	5/16 X 2 1/4	10	
USB-F3	5/16 X 2 1/2	10	
USB-F4	5/16 X 3	10	

(continued...)

## TURNED EYE BOLTS WITH NUTS (cont.)

ZINC

Line: 1427-00



PART NUMBER	SIZE	QTY/BX	LIST PRICE
USB-F5	5/16 X 3 1/2	10	
USB-F6	5/16 X 4	10	
USB-F6A	5/16 X 4 1/2	10	
USB-F7	5/16 X 5	10	
USB-F8	5/16 X 6	10	
USB-F9	5/16 X 6 1/2	10	
USB-G1	3/8 X 1	10	
USB-G2	3/8 X 2	10	
USB-G2A	3/8 X 2 1/2 X 3 3/4	10	
USB-G3	3/8 X 2 1/2	10	
USB-G4	3/8 X 3	10	
USB06096	3/8 X 3 (NO NUTS)	25	
USB-G5	3/8 X 3 1/2	10	
USB-G6	3/8 X 4	10	
USB-G7	3/8 X 5	10	
USB-G8	3/8 X 6	10	
USB-G9	3/8 X 8	10	
USB-G10	3/8 X 10	10	
USB-G11	3/8 X 12	10	
USB-H1	7/16 X 6	10	
USB-H2	7/16 X 8	10	
USB-J1	1/2 X 2	10	
USB-J2	1/2 X 4	10	
USB-J3	1/2 X 6	10	
USB-J4	1/2 X 8	10	
USB-J5	1/2 X 10	10	

**DROP FORGED EYE BOLTS**

GALVANIZED

Line: 1428-00



PART NUMBER	SIZE	QTY/BX	LIST PRICE
UTB04064	1/4 X 2	10	
UTB04096	1/4 X 3	10	
UTB04128	1/4 X 4	10	
UTB04160	1/4 X 5	10	
UTB05072	5/16 X 2 1/4	10	
UTB05096	5/16 X 3	10	
UTB05104	5/16 X 3 1/4	10	
UTB05136	5/16 X 4 1/4	10	
UTB05160	5/16 X 5	10	
UTB05192	5/16 X 6	10	
UTB06080	3/8 X 2 1/2	10	
UTB06096	3/8 X 3	10	
UTB06128	3/8 X 4	10	
UTB06136	3/8 X 4 1/4	10	
UTB06144	3/8 X 4 1/2	10	
UTB06160	3/8 X 5	10	
UTB06192	3/8 X 6	10	
UTB06256	3/8 X 8	10	
UTB06320	3/8 X 10	10	
UTB08064	1/2 X 2	10	
UTB08104	1/2 X 3 1/4	10	
UTB08128	1/2 X 4	10	
UTB08144	1/2 X 4 1/2	10	
UTB08192	1/2 X 6	10	
UTB08256	1/2 X 8	5	
UTB08320	1/2 X 10	5	
UTB08384	1/2 X 12	5	
UTB10128	5/8 X 4	5	
UTB10144	5/8 X 4 1/2	5	
UTB10160	5/8 X 5	5	
UTB10192	5/8 X 6	5	
UTB10256	5/8 X 8	1	
UTB10320	5/8 X 10	1	
UTB10384	5/8 X 12	1	
UTB12128	3/4 X 4	5	
UTB12144	3/4 X 4 1/2	5	
UTB12192	3/4 X 6	5	
UTB12256	3/4 X 8	1	
UTB12320	3/4 X 10	1	
UTB12384	3/4 X 12	1	
UTB14160	7/8 X 5	1	
UTB14256	7/8 X 8	1	
UTB16192	1 X 6	1	
UTB16320	1 X 10	1	

**DROP FORGED EYE BOLTS (cont.)**

GALVANIZED

Line: 1428-00



PART NUMBER	SIZE	QTY/BX	LIST PRICE
UTB16384	1 X 12	1	
UTB16576	1 X 18	1	
UTB16768	1 X 24	1	

**DROP FORGED SHOULDER TYPE EYE BOLTS**

GALVANIZED

Line: 1429-00



PART NUMBER	SIZE	QTY/BX	LIST PRICE
UUB04064	1/4 X 2	10	
UUB04128	1/4 X 4	10	
UUB05072	5/16 X 2 1/4	10	
UUB05136	5/16 X 4 1/4	10	
UUB06080	3/8 X 2 1/2	10	
UUB06080316SS	3/8 X 2 1/2	1	
UUB06136	3/8 X 4 1/4	10	
UUB08064	1/2 X 2	10	
UUB08104	1/2 X 3 1/4	10	
UUB08192	1/2 X 6	10	
UUB08104316SS	1/2 X 3 1/4	1	
UUB10144	5/8 X 4 1/2	5	
UUB12144	3/4 X 4 1/2	5	
UUB10192	5/8 X 6	5	
UUB12192	3/4 X 6	5	
UUB14160	7/8 X 5	1	
UUB14256	7/8 X 8	1	
UUB16192	1 X 6	1	
UUB16288	1 X 9	1	

**DROP FORGED HEAT TREATED MACHINE EYE BOLTS**

PLAIN FINISH

Line: 1430-00



PART NUMBER	SIZE	QTY/BX	LIST PRICE
UVB04032	1/4 X 1	1	
UVB05036	5/16 X 1 1/8	1	
UVB06040	3/8 X 1 1/4	1	
UVB07046	7/16 X 1 3/8	1	
UVB08048	1/2 X 1 1/2	1	
UVB09052	9/16 X 1 5/8	1	
UVB10056	5/8 X 1 3/4	1	
UVB12064	3/4 X 2	1	
UVB14072	7/8 X 2 1/4	1	
UVB16080	1 X 2 1/2	1	
UVB18088	1 1/8 X 2 3/4	1	
UVB20096	1 1/4 X 3	1	
UVB24112	1 1/2 X 3 1/2	1	

## DROP FORGED HT MACH SHOULDER EYE BOLTS

PLAIN FINISH

Line: 1431-00



PART NUMBER	SIZE	QTY/BX	LIST PRICE
UWB04032	1/4 X 1	1	
UWB05036	5/16 X 1 1/8	1	
UWB06040	3/8 X 1 1/4	1	
UWB07046	7/16 X 1 3/8	1	
UWB08048	1/2 X 1 1/2	1	
UWB09052	9/16 X 1 5/8	1	
UWB10056	5/8 X 1 3/4	1	
UWB12064	3/4 X 2	1	
UWB14072	7/8 X 2 1/4	1	
UWB16080	1 X 2 1/2	1	
UWB18088	1 1/8 X 2 3/4	1	
UWB20096	1 1/4 X 3	1	
UWB24112	1 1/2 X 3 1/2	1	

## DROP FORGED BLANK ROD END

Line: 1432-00



PART NUMBER	SIZE	QTY/BX	LIST PRICE
UXB04096	1/4 X 3	10	
UXB04192	1/4 X 6	10	
UXB05096	5/16 X 3	10	
UXB05192	5/16 X 6	10	
UXB06068	3/8 X 2 1/8	10	
UXB06080	3/8 X 2 1/2	10	
UXB06096	3/8 X 3	10	
UXB06192	3/8 X 6	10	
UXB07192	7/16 X 6	10	
UXB08056	1/2 X 1 3/4	10	
UXB08100	1/2 X 3 1/8	10	
UXB08112	1/2 X 3 1/2	10	
UXB08192	1/2 X 6	10	
UXB08320	1/2 X 10	1	
UXB10096	5/8 X 3	5	
UXB10192	5/8 X 6	5	
UXB10256	5/8 X 8	1	
UXB10320	5/8 X 10	1	
UXB12112	3/4 X 3 1/2	5	
UXB12192	3/4 X 6	5	
UXB12320	3/4 X 10	1	
UXB14192	7/8 X 6	1	
UXB14384	7/8 X 12	1	
UXB16192	1 X 6	1	
UXB16384	1 X 12	1	
UXB20384	1 1/4 X 12	1	

## DROP FORGED EYE NUT REGULAR PAT

PLAIN FINISH

Line: 1432-01



PART NUMBER	SIZE	QTY/BX	LIST PRICE
ATH04	1/4-20 (C186A)	1	
ATH05	5/16-18 (C186B)	1	
ATH06	3/8-16 (C187A)	1	
ATH07	7/16-14 (C185B)	1	
ATH08	1/2-13 (C185A)	1	
ATH10	5/8-11 (C181A)	1	
ATH12	3/4-10 (C184A)	1	
ATH14	7/8-9 (C188A)	1	
ATH16	1-8 (C188B)	1	

## DROP FORGED EYE NUT REGULAR

HOT DIPPED GALVANIZED

Line: 1432-02



PART NUMBER	SIZE	QTY/BX	LIST PRICE
ATJ04	1/4-20 (C186AG)	1	
ATJ05	5/16-18 (C186BG)	1	
ATJ06	3/8-16 (C187AG)	1	
ATJ07	7/16-14 (C185BG)	1	
ATJ08	1/2-13 (C185AG)	1	
ATJ10	5/8-11 (C181AG)	1	
ATJ12	3/4-10 (C184AG)	1	
ATJ14	7/8-9 (C188AG)	1	
ATJ16	1-8 (C188BG)	1	

## DROP FORGED EYE NUT HEAVY DUTY

PLAIN FINISH

Line: 1432-03



PART NUMBER	SIZE	QTY/BX	LIST PRICE
ATK06	3/8-16 #100	1	
ATK08	1/2-13 #101	1	
ATK10	5/8-11 #102	1	
ATK12	3/4-10 #103	1	
ATK14	7/8-9 #104	1	
ATK16	1-8 #105	1	
ATK18	1 1/8-7 #105A	1	
ATK20	1 1/4-7 #106	1	
ATK24	1 1/2-6 #107	1	



### ECONOMY SCREW PIN ANCHOR SHACKLE

PLATED

Line: 1432-10



PART NUMBER	SIZE	QTY/BX	LIST PRICE
AYR03	3/16	1	
AYR04	1/4	1	
AYR05	5/16	1	
AYR06	3/8	1	
AYR07	7/16	1	
AYR08	1/2	1	
AYR10	5/8	1	
AYR12	3/4	1	
AYR14	7/8	1	
AYR16	1	1	

### SCREW PIN ANCHOR SHACKLE

304 STAINLESS STEEL

Line: 1432-11



PART NUMBER	SIZE	QTY/BX	LIST PRICE
AYT04	1/4	1	
AYT05	5/16	1	
AYT06	3/8	1	
AYT08	1/2	1	
AYT10	5/8	1	
AYT12	3/4	1	

### DROP FORGED SCREW PIN ANCHOR SHACKLE

GALVANIZED

Line: 1433-00



PART NUMBER	SIZE	QTY/BX	LIST PRICE
UYB03	3/16	1	
UYB04	1/4	1	
UYB05	5/16	1	
UYB05CH	5/16	1	
UYB06	3/8	1	
UYB06CH	3/8	1	
UYB07	7/16	1	
UYB08	1/2	1	
UYB08CH	1/2	1	
UYB10	5/8	1	
UYB10CH	5/8	1	
UYB12	3/4	1	
UYB12CH	3/4	1	
UYB14	7/8	1	
UYB16	1	1	
UYB16CH	1	1	

### DROP FORGED SHACKLE SCREW PIN CHAIN

GALVANIZED

Line: 1435-00



PART NUMBER	SIZE	QTY/BX	LIST PRICE
VAB05	5/16	1	
VAB06	3/8	1	
VAB07	7/16	1	
VAB08	1/2	1	
VAB10	5/8	1	
VAB12	3/4	1	
VAB14	7/8	1	
VAB16	1	1	

### DROP FORGED SHACKLE SCREW PIN CHAIN

PLAIN FINISH

Line: 1436-00



PART NUMBER	SIZE	QTY/BX	LIST PRICE
VBB04	1/4	1	
VBB05	5/16	1	
VBB06	3/8	1	
VBB07	7/16	1	
VBB08	1/2	1	
VBB10	5/8	1	
VBB12	3/4	1	
VBB14	7/8	1	
VBB16	1	1	

### DROP FORGED SHACKLE ROUND PIN ANCHOR

GALVANIZED

Line: 1437-00



PART NUMBER	SIZE	QTY/BX	LIST PRICE
VDB04	1/4	1	
VDB06	3/8	1	
VDB08	1/2	1	
VDB10	5/8	1	
VDB12	3/4	1	
VDB14	7/8	1	
VDB16	1	1	

### DROP FORGED SHACKLE ROUND PIN CHAIN

GALVANIZED

Line: 1439-00



PART NUMBER	SIZE	QTY/BX	LIST PRICE
VFB04	1/4	1	
VFB05	5/16	1	
VFB06	3/8	1	
VFB07	7/16	1	
VFB08	1/2	1	
VFB10	5/8	1	
VFB12	3/4	1	
VFB14	7/8	1	
VFB16	1	1	

CALL: (800) 723-2826

## DROP FORGED SHACKLE ROUND PIN CHAIN

PLAIN FINISH

Line: 1440-00



PART NUMBER	SIZE	QTY/BX	LIST PRICE
VHB08	1/2	1	
VHB10	5/8	1	
VHB12	3/4	1	
VHB16	1	1	
VHB18	1 1/8	1	

## DROP FORGED SHACKLE SAFETY CHAIN

GALVANIZED

Line: 1443-00



PART NUMBER	SIZE	QTY/BX	LIST PRICE
VKB08	1/2	1	
VKB10	5/8	1	
VKB12	3/4	1	
VKB14	7/8	1	
VKB16	1	1	

## DROP FORGED WIRE ROPE CLIPS

GALVANIZED & STAINLESS STEEL

Line: 1445-00



PART NUMBER	SIZE	QTY/BX	LIST PRICE
VMB04SS304	1/4 (304 STAINLESS STEEL)	10	
VMB08SS	1/2 (304 STAINLESS STEEL)	1	
VMB01SS	1/16 (304 STAINLESS STEEL)	10	
VMB02	1/8	10	
VMB02SS	1/8 (304 STAINLESS STEEL)	10	
VMB03	3/16	10	
VMB03SS	3/16 (304 STAINLESS STEEL)	10	
VMB04	1/4	10	
VMB04SS	1/4 (304 STAINLESS STEEL)	10	
VMB05	5/16	5	
VMB05SS	5/16 (304 STAINLESS STEEL)	10	
VMB06	3/8	5	
VMB06SS	3/8 (304 STAINLESS STEEL)	5	
VMB07	7/16	1	
VMB08	1/2	1	
VMB09	9/16	1	
VMB10	5/8	1	
VMB10SS	5/8 (304 STAINLESS STEEL)	1	
VMB12	3/4	1	
VMB14	7/8	1	
VMB16	1	1	
VMB18	1 1/8	1	
VMB20	1 1/4	1	
VMB24	1 1/2	1	

## MALLEABLE WIRE ROPE CLIPS

GALVANIZED

Line: 1447-00



PART NUMBER	SIZE	QTY/BX	LIST PRICE
VPB01	1/16	10	
VPB44	3/32	10	
VPB02	1/8	10	
VPB03	3/16	10	
VPB04	1/4	10	
VPB05	5/16	5	
VPB06	3/8	5	
VPB07	7/16	1	
VPB08	1/2	1	
VPB09	9/16	1	
VPB10	5/8	1	
VPB12	3/4	1	
VPB14	7/8	1	
VPB16	1	1	
VPB18	1 1/8	1	
VPB20	1 1/4	1	
VPB22	1 3/8	1	
VPB24	1 1/2	1	

### HOW TO USE CLIPS PROPERLY

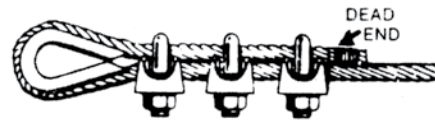

U-BOLT MUST BEAR ON DEAD END OF ROPE.

NEVER USE LESS THAN MINIMUM NUMBER OF CLIPS AS LISTED.

SPACE CLIPS 6 TIMES THE ROPE DIAMETER

#### FORGED

Size	Minimum Number of Clips Required
1/8	2
3/16	2
1/4	2
5/16	2
3/8	2
7/16	3
1/2	3
9/16	3
5/8	3
3/4	4
7/8	4
1	5
1 1/8	6
1 1/4	7
1 3/8	7
1 1/2	8
1 5/8	8
1 3/4	8
2	8

#### MALLEABLE

Size	Minimum Number of Clips Required
1/6	3
1/8	3
3/16	3
1/4	3
5/16	3
3/8	3
7/16	4
1/2	4
5/8	4
3/4	5
7/8	5
1	6
1 1/8	7



**WIRE ROPE THIMBLES**

GALVANIZED  
Line: 1448-00



PART NUMBER	SIZE	QTY/BX	LIST PRICE
VRB16	1	10	
VRB02	1/8	10	
VRB03	3/16	10	
VRB04	1/4	10	
VRB04HVY	1/4 (HEAVY)	10	
VRB05	5/16	10	
VRB06	3/8	10	
VRB07	7/16	10	
VRB08	1/2	10	
VRB10	5/8	10	
VRB12	3/4	10	
VRB14	7/8	10	

**CLEVIS GRAB HOOK**

DROP FORGED HT HDG  
Line: 1449-00



PART NUMBER	SIZE	QTY/BX	LIST PRICE
VSB04	1/4	1	
VSB05	5/16	1	
VSB06	3/8	1	
VSB07	7/16	1	
VSB08	1/2	1	
VSB10	5/8	1	

**CLEVIS SLIP HOOK**

DROP FORGED HOT GALVANIZED  
Line: 1450-00



PART NUMBER	SIZE	QTY/BX	LIST PRICE
VTB04	1/4	1	
VTB05	5/16	1	
VTB06	3/8	1	
VTB07	7/16 (PLAIN FINISH)	1	
VTB08	1/2	1	
VTB10	5/8	1	

**GRAB HOOK DROP FORGED**

HEAT TREATED PLAIN  
Line: 1451-00



PART NUMBER	SIZE	QTY/BX	LIST PRICE
VUB04	1/4	1	
VUB05	5/16	1	
VUB06	3/8	1	
VUB07	7/16	1	
VUB08	1/2	1	
VUB10	5/8	1	

**SLIP HOOK DROP FORGED**

HEAT TREATED PLAIN  
Line: 1452-00



PART NUMBER	SIZE	QTY/BX	LIST PRICE
VVB04	1/4	1	
VVB04HDG	1/4 (HOT DIP GALVANIZED)	1	
VVB05	5/16	1	
VVB06	3/8	1	
VVB08	1/2	1	
VVB10	5/8	1	

**SAFETY SLIP HOOK DROP FORGED**

HEAT TREATED PLAIN  
Line: 1453-00



PART NUMBER	SIZE	QTY/BX	LIST PRICE
HWD22	3/4	1	
HWD23	1	1	

**STEEL S HOOKS**

ZINC  
Line: 1454-00



PART NUMBER	SIZE	QTY/BX	LIST PRICE
VWB070	.070 (1/16) x 1 1/16	50	
VWB764	7/64 .105 x 1 3/32	50	
VWB66	1/8 .120 x 1 5/16	50	
VWB88	5/32 .148 x 2	50	
VWB88SS	5/32 ST/ST	50	
VWB03	3/16 .188 x 2 7/8	50	
VWB21	7/32 .220 x 2 1/8	50	
VWB04	1/4 .250 x 2 1/2	50	
VWB05	5/16 .312 x 2 5/8	50	
VWB06	3/8 .375 x 3 1/4	25	



**CALL - 1 (800) 723-2826**

## CHAIN LAP LINKS

ZINC PLATED

Line: 1455-00



PART NUMBER	SIZE	QTY/BX	LIST PRICE
VXB02024	1/8 X 3/4	10	
VXB03032	3/16 X 1	1	
VXB04040	1/4 X 1 1/4	1	
VXB04048	1/4 X 1 1/2	50	
VXB05048	5/16 X 1 1/2	1	
VXB06052	3/8 X 1 5/8	1	
VXB08080	1/2 X 2 1/2	1	

## CHAIN CONNECTING LINKS

MALLEABLE

Line: 1456-00



PART NUMBER	SIZE	QTY/BX	LIST PRICE
VZB03	3/16	1	
VZB04	1/4	1	
VZB05	5/16	1	
VZB06	3/8	1	
VZB07	7/16	1	
VZB08	1/2	1	
VZB10X	5/8	1	

## THREADED FEMALE YOKE ENDS UNF

PLAIN

Line: 1471-00



PART NUMBER	SIZE	QTY/BX	LIST PRICE
DVC51	1/4-28	1	
DVC52	5/16-24	1	
DVC53	3/8-24	1	
DVC54	7/16-20	1	
DVC55	1/2-20	1	
DVC56	5/8-18	1	
DVC57	3/4-16	1	

## STEEL CHAIN LINK COLD SHUTS

Line: 3402-00



PART NUMBER	SIZE	QTY/BX	LIST PRICE
JPF04	1/4	5	
JPF05	5/16	5	
JPF06	3/8	5	
JPF07X	7/16	5	
JPF08	1/2	5	
JPF10X	5/8	5	

# SECTION 16 PRODUCT INDEX

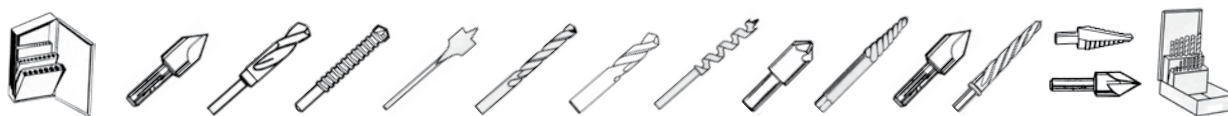

## DRILL BITS

Line Description	Alpha	Line#	Page#
FRACTIONAL HI-SPEED SPLIT POINT PREM JOBBER DRILL BITS	<b>WUB</b>	<b>1473-00</b>	16-5
118° POINT HI-SPEED STD FRACTIONAL JOBBER DRILL BITS	<b>PEP</b>	<b>1473-10</b>	16-5
135° POINT HI-SPEED STD FRACTIONAL JOBBER DRILL BITS	<b>WVB</b>	<b>1474-00</b>	16-6
135° POINT HI-SPEED STD NUMBER JOBBER DRILL BITS	<b>AST</b>	<b>1474-01</b>	16-6
135° POINT HI-SPEED STD LETTER JOBBER DRILL BITS	<b>ASV</b>	<b>1474-02</b>	16-7
135° POINT HI-SPEED FRACTIONAL FLAT SHANK MECH LENGTH	<b>BHJ</b>	<b>1474-03</b>	16-7
135° SP/POINT HI-SPEED NUMBER PREMIUM JOBBER DRILL BITS	<b>XKB</b>	<b>1476-00</b>	16-8
135° SP/POINT HI-SPEED LETTER PREMIUM JOBBER DRILL BITS	<b>XJB</b>	<b>1477-00</b>	16-9
PREMIUM HEAVY DUTY COLBALT FRACTIONAL JOBBER DRILL BITS	<b>XGB</b>	<b>1478-00</b>	16-9
GLOBAL FRACTIONAL JOB DRILL BITS	<b>ATD</b>	<b>1478-10</b>	16-10
PREM SP/PT COBALT NUMBER JOBBER DRILL BITS	<b>ATE</b>	<b>1478-11</b>	16-10
PREM SP/PT COBALT LETTER JOBBER DRILL BITS	<b>ATF</b>	<b>1478-12</b>	16-11
135° SP/POINT STUBBY FRACTIONAL HEAVY DUTY DRILL BITS	<b>XAB</b>	<b>1479-00</b>	16-11
135° SP/POINT STUBBY NUMBER HEAVY DUTY DRILL BITS	<b>XLB</b>	<b>1480-00</b>	16-12
135° SP/POINT STUBBY FRACTIONAL GLOBAL DRILL BITS	<b>ASX</b>	<b>1480-01</b>	16-12
135° SP/POINT STUBBY LETTER HEAVY DUTY DRILL BITS	<b>ASZ</b>	<b>1480-03</b>	16-13
135° SP/POINT 1/2" SHANK FRACTIONAL S&D PREM DRILL BITS	<b>WWB</b>	<b>1481-00</b>	16-13
118° 1/2" SHANK FRACTIONAL S&D DRILL BITS	<b>ASW</b>	<b>1481-01</b>	16-14
135° SP/POINT 1/4" SHANK FRACTIONAL DRILL BITS	<b>WXB</b>	<b>1482-00</b>	16-14
135° SP/POINT 3/8" SHANK FRACTIONAL DRILL BITS	<b>BKH</b>	<b>1482-01</b>	16-14
118° TAPER LENGTH STRA SHANK DRILL BITS	<b>WYB</b>	<b>1485-00</b>	16-14
LONG BOY 12" & 18" STRA SHANK DRILL BITS	<b>ZTB</b>	<b>1486-00</b>	16-15
MULTI-STEP CONE DRILL HI-SPEED STEEL	<b>AMN</b>	<b>1486-01</b>	16-16
HEX SHANK HI-SPEED DRILL BITS	<b>ATN</b>	<b>1486-02</b>	16-16
LEFT HAND HI-SPEED FRACTIONAL DRILL BITS	<b>AUJ</b>	<b>1486-03</b>	16-16
FLAT PADDLE STYLE WOOD BITS	<b>BDG</b>	<b>1486-04</b>	16-16
BRAD POINT (BULLET) WOOD/PLASTIC BITS	<b>BKT</b>	<b>1486-05</b>	16-17
135° SP/POINT DOUBLE END DRILL BITS	<b>BKL</b>	<b>1486-06</b>	16-17
135° SP/POINT METRIC JOBBER DRILL BITS	<b>BKJ</b>	<b>1486-07</b>	16-17
SHIP HEAD AUGER WOOD BITS STRA SHANK	<b>BKV</b>	<b>1486-08</b>	16-18
GLASS/TILE SPEAR POINTED DRILL BITS	<b>BKK</b>	<b>1486-09</b>	16-18
26 PIECE LETTER DRILL SET WITH INDEX BOX	<b>WSB</b>	<b>1487-00</b>	16-18
METRIC JOBBER DRILL SETS WITH INDEX BOX	<b>WSB</b>	<b>1488-00</b>	16-18
NUMBER JOBBER DRILL SETS WITH INDEX BOX	<b>WSB</b>	<b>1489-00</b>	16-18
FRACTION JOBBER DRILL SETS WITH INDEX BOX	<b>WSB</b>	<b>1490-00</b>	16-18
FRACTION STUBBY FRACTIONAL DRILL SET WITH INDEX	<b>WSB</b>	<b>1491-00</b>	16-18
GREENFIELD TAP & DRILL SETS WITH METAL INDEX	<b>APJ</b>	<b>1491-01</b>	16-18
DRILL INDEX CASES (LESS DRILLS)	<b>WTB</b>	<b>1492-00</b>	16-19
MASTER DRILL COUNTER DISPENSER	<b>WTB</b>	<b>1492-05</b>	16-19

(CONTINUED...)

# SECTION 16 PRODUCT INDEX

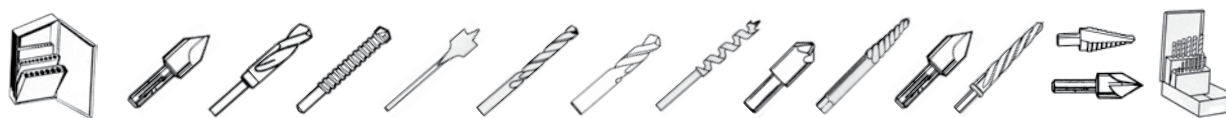

## DRILL BITS (continued)

Line Description	Alpha	Line#	Page#
HI-SPEED DRILL & COUNTERSUNK PLAIN	WPB	1493-00	16-19
HI-SPEED DRILL & COUNTERSUNK BELL	WRB	1494-00	16-19
GREENFIELD SCREW EXTRACTOR SETS WITH CASE	XCB	1496-00	16-19
LITTLE GIANT SCREW EXTRACTORS	YHB	1497-00	16-19
SPIRAL FLUTE FRAME REAMER	BKW	1497-03	16-20
HI-SPEED 60° CENTER REAMER COUNTERSINKS	XDB	1498-00	16-20
HI-SPEED 82° CENTER REAMER COUNTERSINKS	XDB	1499-00	16-20
HI-SPEED 60° SINGLE FLUTE COUNTERSINKS	XEB	1500-00	16-20
HI-SPEED 82° SINGLE FLUTE COUNTERSINKS	XEB	1501-00	16-20
HI-SPEED 60° 3- FLUTE COUNTERSINKS	XFB	1502-00	16-20
HI-SPEED 82° 3- FLUTE COUNTERSINKS	XFB	1503-00	16-20
ECONOMY REGULAR SPIRAL MASONRY BIT	ANW	1503-25	16-20
MASONRY REGULAR SPIRAL CARBIDE TIP DRILL BITS	XMB	1504-00	16-21
MASONRY FAST SPIRAL CARBIDE TIP DRILL BITS	XNB	1505-00	16-21
X-LONG MASONRY REGULAR SPIRAL CARB/TIP DRILL BITS	XPB	1506-00	16-21
SDS ROTARY MASONRY HAMMER BITS	BKR	1507-01	16-22
GROO-V-TIP MULTI-PURPOSE BIT FOR CONCRETE/STEEL	CDJ	1507-05	16-22
UNIPLUS CERAMIC/MASONRY DRILL BIT	BDV	1507-10	16-22



## THREADING TOOLS & SAWS

Line Description	Alpha	Line#	Page#
HI-SPEED GH3 TAPER TAPS - GREENFIELD	XTB	1508-00	16-23
HI-SPEED GH3 PLUG TAPS - GREENFIELD	XUB	1509-00	16-23
HI-SPEED GH3 BOTTOM TAPS - GREENFIELD	XVB	1510-00	16-24
HI-SPEED GH3 TAP SETS (TPB) - GREENFIELD	XWB	1511-00	16-25
HI-SPEED GH3 SPIRAL PT PLUG GUN TAP - GREENFIELD	XXB	1512-00	16-25
HI-SPEED GH3 HEAVY DUTY SPRIAL PT GUN TAP - GREENFIELD	XYB	1513-00	16-26
GROUND THREAD TAPER PIPE TAPS - GREENFIELD	YAB	1514-00	16-26
CARBON STEEL TAPER PIPE TAPS	YBB	1515-00	16-26
HI-SPEED GROUND THREAD METRIC TAPER TAP	YJB	1516-00	16-26
HI-SPEED GROUND THREAD METRIC PLUG TAP	YKB	1517-00	16-26
HI-SPEED GROUND THREAD METRIC BOTTOM PLUG TAP	YLB	1518-00	16-27
HI-SPEED GROUND THREAD METRIC PLUG GUN PLUG TAP	YMB	1519-00	16-27
UN8 SERIES HI-SPEED TAPER TAPS	BKX	1521-01	16-27
INSERT COIL THREAD PLUG TAPS U.N.C.	HXD	1522-00	16-28

(CONTINUED...)

# SECTION 16 PRODUCT INDEX

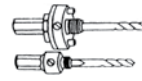

## THREADING TOOLS & SAWS (continued)

Line Description	Alpha	Line#	Page#
INSERT COIL THREAD PLUG TAPS U.N.F.	HYD	1523-00	16-28
INSERT COIL THREAD PLUG TAPS METRIC	HZD	1524-00	16-28
INSERT COIL THREAD PLUG TAPS SPARK PLUG	JAD	1525-00	16-28
HEX RETHRADING BOLT DIE	XZB	1536-00	16-29
HEX SOLID CARBON DIES 1" ACROSS FLATS	YDB	1537-00	16-29
HEX SOLID CARBON DIES 1 3/16" ACROSS FLATS	YDB	1538-00	16-29
HEX SOLID CARBON DIES 1 5/8" ACROSS FLATS	YDB	1539-00	16-29
HEX SOLID CARBON DIES 1 7/16" ACROSS FLATS	YDB	1540-00	16-30
HEX SOLID CARBON RETHRADING DIES METRIC	YNB	1541-00	16-30
HEX SOLID CARBON RETHRADING DIES INCH	YEB	1542-00	16-30
TAP/DIE SETS HI-SPEED & CARBON	BKZ	1542-11	16-30
T HANDLE HAND TAP WRENCHES	YFB	1543-00	16-30
HACK SAW BI-METAL HI-SPEED BLADES	AAC	1544-00	16-31
HOLE SAW BI-METAL HI-SPEED DEEP & REGULAR	AEC	1546-00	16-31
HOLE SAW BI-METAL HI-SPEED KITS	ABT	1546-01	16-32
HOLE SAW ARBORS	AGC	1547-00	16-32
HOLE SAW PILOT DRILLS	AHC	1548-00	16-32

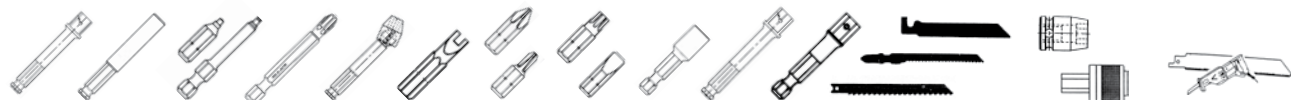

## DRIVER BITS & SAWS

Line Description	Alpha	Line#	Page#
POWER BIT FINDER SLEEVE FULL UNIT HARD	JHV	1549-01	16-32
HEX DRIVE BITS PHILLIPS REDUCED POINT 1/4 DRIVE	AKC	1549-02	16-33
HEX DRIVE BITS PHILLIPS 1/4 DRIVE HARD	AKC	1550-00	16-33
HEX DRIVE BITS PHILLIPS 5/16 DRIVE HARD	AKC	1550-01	16-33
HEX DRIVE BITS LONG PHILLIPS 1/4 DRIVE HARD	AKC	1550-02	16-33
HEX DRIVE BITS LONG PHILLIPS 5/16 DRIVE HARD	AKC	1550-03	16-33
HEX DRIVE BITS LONG PHILLIPS 7/16 DRIVE HARD	AKC	1550-04	16-33
SQUARE PHILLIPS BITS 5/16	JYZ	1550-06	16-33
ACR PHILLIPS HEX POWER DRIVE BITS HARD	BLG	1550-07	16-34
SLOTTED HEX 1/4 DRIVE BITS HARD	ALC	1551-00	16-34
SLOTTED HEX REDUCED POINT 1/4 DRIVE HARD	ALC	1551-01	16-34
SLOTTED HEX 5/16 DRIVE BITS HARD	ALC	1551-02	16-34
SLOTTED HEX LONG SHANK 1/4 DRIVE BITS HARD	JGV	1551-03	16-34
TORX BIT 1/4 HEX DRIVE HARD	JJV	1551-06	16-34
TORX BIT 5/16 HEX DRIVE HARD	JJS	1551-07	16-35
TORX BIT 1/4 HEX DRIVE LONG SHANK HARD	JJV	1551-08	16-35

(CONTINUED...)

# SECTION 16 PRODUCT INDEX

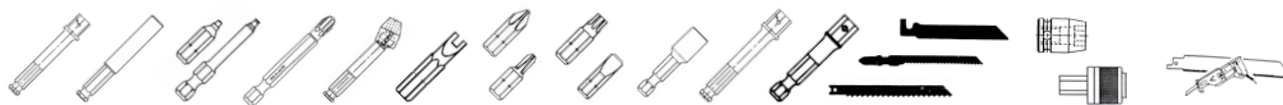

## DRIVER BITS & SAWS (continued)

Line Description	Alpha	Line#	Page#
POSIDRIVE PHILLIPS 1/4 HEX DRIVE HARD	<b>JKV</b>	<b>1551-09</b>	16-35
POSIDRIVE PHILLIPS 5/16 HEX DRIVE HARD	<b>JKV</b>	<b>1551-10</b>	16-35
TORX TAMPER PROOF 1/4 HEX DRIVE HARD	<b>BPG</b>	<b>1551-11</b>	16-35
QUADREX PHIL/SQUARE 1/4 HEX DRIVE BIT HARD	<b>CEV</b>	<b>1551-15</b>	16-35
SQUARE SOCKET 1/4 HEX DRIVE BIT HARD	<b>AUS</b>	<b>1551-20</b>	16-35
SPANNER TAMPER PROOF HEX DRIVE BIT HARD	<b>BLH</b>	<b>1551-21</b>	16-36
5/16 HEX DRIVE MAGNETIC BIT HOLDER	<b>AMC</b>	<b>1552-00</b>	16-36
5/16 HEX DRIVE BIT HOLDER	<b>AMC</b>	<b>1552-01</b>	16-36
1/4 HEX DRIVE MAGNETIC BIT HOLDER	<b>AMC</b>	<b>1553-00</b>	16-36
1/4 HEX DRIVE BIT HOLDER	<b>AMC</b>	<b>1553-01</b>	16-36
7/16 HEX DRIVE MAGNETIC BIT HOLDER	<b>AMC</b>	<b>1553-02</b>	16-36
7/16 HEX DRIVE BIT HOLDER	<b>AMC</b>	<b>1553-03</b>	16-36
SQUARE DRIVE BIT HOLDER	<b>JMV</b>	<b>1553-05</b>	16-36
SQUARE DRIVE MAGNETIC BIT HOLDER	<b>JMV</b>	<b>1553-06</b>	16-36
HEX TO SQUARE DRIVE ADAPTERS	<b>JNV</b>	<b>1553-07</b>	16-36
1/4 HEX DRIVE 6 POINT MAGNETIC NUT SETTER	<b>JPV</b>	<b>1553-08</b>	16-37
1/4 SQUARE MAGNETIC SOCKET	<b>ANC</b>	<b>1554-00</b>	16-37
3/8 SQUARE MAGNETIC SOCKET	<b>ANC</b>	<b>1554-01</b>	16-37
HEX SOCKET BITS 1/4 DRIVE	<b>KAA</b>	<b>1554-02</b>	16-37
1/4" SQUARE MALE EXTENSION	<b>APC</b>	<b>1555-00</b>	16-37
3/8" SQUARE MALE EXTENSION	<b>APC</b>	<b>1555-01</b>	16-37
REVERSABLE MAGNETIC SOCKETS (SMS HD)	<b>JRV</b>	<b>1555-02</b>	16-38
HEX DRIVE SHANKS FOR MAGNETIC SOCKETS	<b>JSV</b>	<b>1555-03</b>	16-38
UNIVERSAL JOINT SOCKET EXTENSION	<b>AUM</b>	<b>1555-05</b>	16-38
BIT/DRIVER/CHUCK TRAY ASSORTMENT	<b>BBZ</b>	<b>1555-09</b>	16-38
MISCELLANEOUS TOOLS AND PARTS	<b>JRZ</b>	<b>1555-10</b>	16-38
BI-METAL SABRE SAW BLADE 1/2" SHANK	<b>AFZ</b>	<b>1555-11</b>	16-38
SABRE SAW BLADES 1/4 SHANK	<b>AFZ</b>	<b>1555-12</b>	16-38
CARBON RECIPROCATING SAW BLADES	<b>ASS</b>	<b>1555-13</b>	16-38
BAYONET JIG SAW BLADES BI-METAL	<b>ASP</b>	<b>1555-14</b>	16-39
BOSCH JIG SAW BLADES	<b>ASR</b>	<b>1555-15</b>	16-39
GRIT EDGE RECEPT & JIG SAW BLADES	<b>BLF</b>	<b>1555-16</b>	16-39
MECHANIC 1/4 HEX DRIVE SCREW & NUT SETTER	<b>ANV</b>	<b>1555-25</b>	16-39



### 135° 150A-SP HI-SPEED SPLIT POINT

FRACTIONAL JOBBER DRILL BIT - PREMIUM

Line: 1473-00



PART NUMBER	SIZE	QTY/BX	LIST PRICE
WUB01	1/64	12	
WUB02	1/32	12	
WUB03	3/64	12	
WUB04	1/16	12	
WUB05	5/64	12	
WUB06	3/32	12	
WUB07	7/64	12	
WUB08	1/8	12	
WUB09	9/64	12	
WUB10	5/32	12	
WUB11	11/64	12	
WUB12	3/16	12	
WUB13	13/64	12	
WUB14	7/32	12	
WUB15	15/64	12	
WUB16	1/4	12	
WUB17	17/64	12	
WUB18	9/32	12	
WUB19	19/64	6	
WUB20	5/16	6	
WUB21	21/64	6	
WUB22	11/32	6	
WUB23	23/64	6	
WUB24	3/8	6	
WUB25	25/64	6	
WUB26	13/32	6	
WUB27	27/64	6	
WUB28	7/16	6	
WUB29	29/64	6	
WUB30	15/32	6	
WUB31	31/64	6	
WUB32	1/2	6	

### 118° HI-SPEED 2Q JOBBER LENGTH

DRILL BITS

Line: 1473-10



PART NUMBER	SIZE	QTY/BX	LIST PRICE
PEP04	1/16	12	
PEP05	5/64	12	
PEP06	3/32	12	
PEP07	7/64	12	
PEP08	1/8	12	
PEP09	9/64	12	
PEP10	5/32	12	
PEP11	11/64	12	
PEP12	3/16	12	
PEP13	13/64	12	
PEP14	7/32	12	
PEP15	15/64	12	
PEP16	1/4	12	
PEP17	17/64	12	
PEP18	9/32	12	
PEP19	19/64	6	
PEP20	5/16	6	
PEP21	21/64	6	
PEP22	11/32	6	
PEP23	23/64	6	
PEP24	3/8	6	
PEP25	25/64	6	
PEP26	13/32	6	
PEP27	27/64	6	
PEP28	7/16	6	
PEP29	29/64	6	
PEP30	15/32	6	
PEP31	31/64	6	
PEP32	1/2	6	

# HI-SPEED STANDARD 135° SPLIT POINT

JOBBER DRILL BIT

Line: 1474-00



PART NUMBER	SIZE	QTY/BX	LIST PRICE
WVB03	3/64	12	
WVB04	1/16	12	
WVB05	5/64	12	
WVB06	3/32	12	
WVB07	7/64	12	
WVB08	1/8	12	
WVB09	9/64	12	
WVB10	5/32	12	
WVB11	11/64	12	
WVB12	3/16	12	
WVB13	13/64	12	
WVB14	7/32	12	
WVB15	15/64	12	
WVB16	1/4	12	
WVB17	17/64	12	
WVB18	9/32	12	
WVB19	19/64	6	
WVB20	5/16	6	
WVB21	21/64	6	
WVB22	11/32	6	
WVB23	23/64	6	
WVB24	3/8	6	
WVB25	25/64	6	
WVB26	13/32	6	
WVB27	27/64	6	
WVB28	7/16	6	
WVB29	29/64	6	
WVB30	15/32	6	
WVB31	31/64	6	
WVB32	1/2	6	

# STANDARD 135° NUMBER SPLIT POINT

JOBBER DRILL BIT

Line: 1474-01



PART NUMBER	SIZE	QTY/BX	LIST PRICE
AST60N	#60	12	
AST59N	#59	12	
AST58N	#58	12	
AST57N	#57	12	
AST56N	#56	12	
AST55N	#55	12	
AST54N	#54	12	
AST53N	#53	12	
AST52N	#52	12	
AST51N	#51	12	
AST50N	#50	12	
AST49N	#49	12	
AST48N	#48	12	
AST47N	#47	12	
AST46N	#46	12	
AST45N	#45	12	
AST44N	#44	12	
AST43N	#43	12	
AST42N	#42	12	
AST41N	#41	12	
AST40N	#40	12	
AST39N	#39	12	
AST38N	#38	12	
AST37N	#37	12	
AST36N	#36	12	
AST35N	#35	12	
AST34N	#34	12	
AST33N	#33	12	
AST32N	#32	12	
AST31N	#31	12	
AST30N	#30	12	
AST29N	#29	12	
AST28N	#28	12	
AST27N	#27	12	
AST26N	#26	12	
AST25N	#25	12	
AST24N	#24	12	
AST23N	#23	12	
AST22N	#22	12	
AST21N	#21	12	
AST20N	#20	12	
AST19N	#19	12	
AST18N	#18	12	
AST17N	#17	12	

(continued...)

### STANDARD 135° NUMBER SPLIT POINT<sup>(cont.)</sup>

JOBBER DRILL BIT

Line: 1474-01



PART NUMBER	SIZE	QTY/BX	LIST PRICE
AST16N	#16	12	
AST15N	#15	12	
AST14N	#14	12	
AST13N	#13	12	
AST12N	#12	12	
AST11N	#11	12	
AST10N	#10	12	
AST09N	#9	12	
AST08N	#8	12	
AST07N	#7	12	
AST06N	#6	12	
AST05N	#5	12	
AST04N	#4	12	
AST03N	#3	12	
AST02N	#2	12	
AST01N	#1	12	

### STANDARD 135° JOBBER LEN LETTER SPLIT POINT

JOBBER DRILL BIT

Line: 1474-02



PART NUMBER	SIZE	QTY/BX	LIST PRICE
ASVA	A	12	
ASVB	B	12	
ASVC	C	12	
ASVD	D	12	
ASVE	E	12	
ASVF	F	12	
ASVG	G	12	
ASVH	H	12	
ASVI	I	12	
ASVJ	J	12	
ASVK	K	12	
ASVL	L	12	
ASVM	M	6	
ASVN	N	6	
ASVO	O	6	
ASVP	P	6	
ASVQ	Q	6	
ASVR	R	6	
ASVS	S	6	
ASVT	T	6	
ASVU	U	6	
ASVV	V	6	
ASVW	W	6	

(continued...)

### STANDARD 135° JOBBER LEN LETTER SPLIT POINT

JOBBER DRILL BIT

Line: 1474-02



PART NUMBER	SIZE	QTY/BX	LIST PRICE
ASVX	X	6	
ASVY	Y	6	
ASVZ	Z	6	

### PREMIUM FLAT SHANK 135° SPLIT POINT

MECH LEN DRILL BIT 175AG

Line: 1474-03



PART NUMBER	SIZE	QTY/BX	LIST PRICE
BHJSPM29	1/16 - 1/2 BY 64THS DRILL SET	1	
BHJ12	3/16	12	
BHJ13	13/64	12	
BHJ14	7/32	12	
BHJ15	15/64	12	
BHJ16	1/4	12	
BHJ17	17/64	12	
BHJ18	9/32	12	
BHJ19	19/64	6	
BHJ20	5/16	6	
BHJ21	21/64	6	
BHJ22	11/32	6	
BHJ23	23/64	6	
BHJ24	3/8	6	
BHJ25	25/64	6	
BHJ26	13/32	6	
BHJ27	27/64	6	
BHJ28	7/16	6	
BHJ29	29/64	6	
BHJ30	15/32	6	
BHJ31	31/64	6	
BHJ32	1/2	6	

## PREMIUM 135° 150A-SP SPLIT POINT NUMBER

JOBBER DRILL BIT

Line: 1476-00



PART NUMBER	SIZE	QTY/BX	LIST PRICE
XKB80N	80	12	
XKB79N	79	12	
XKB78N	78	12	
XKB77N	77	12	
XKB76N	76	12	
XKB75N	75	12	
XKB74N	74	12	
XKB73N	73	12	
XKB72N	72	12	
XKB71N	71	12	
XKB70N	70	12	
XKB69N	69	12	
XKB68N	68	12	
XKB67N	67	12	
XKB66N	66	12	
XKB65N	65	12	
XKB64N	64	12	
XKB63N	63	12	
XKB62N	62	12	
XKB61N	61	12	
XKB60N	60	12	
XKB59N	59	12	
XKB58N	58	12	
XKB57N	57	12	
XKB56N	56	12	
XKB55N	55	12	
XKB54N	54	12	
XKB53N	53	12	
XKB52N	52	12	
XKB51N	51	12	
XKB50N	50	12	
XKB49N	49	12	
XKB48N	48	12	
XKB47N	47	12	
XKB46N	46	12	
XKB45N	45	12	
XKB44N	44	12	
XKB43N	43	12	
XKB42N	42	12	
XKB41N	41	12	
XKB40N	40	12	
XKB39N	39	12	
XKB38N	38	12	

(continued...)

## PREMIUM 135° 150A-SP SPLIT POINT NUMBER (cont.)

JOBBER DRILL BIT

Line: 1476-00



PART NUMBER	SIZE	QTY/BX	LIST PRICE
XKB37N	37	12	
XKB36N	36	12	
XKB35N	35	12	
XKB34N	34	12	
XKB33N	33	12	
XKB32N	32	12	
XKB31N	31	12	
XKB30N	30	12	
XKB29N	29	12	
XKB28N	28	12	
XKB27N	27	12	
XKB26N	26	12	
XKB25N	25	12	
XKB24N	24	12	
XKB23N	23	12	
XKB22N	22	12	
XKB21N	21	12	
XKB20N	20	12	
XKB19N	19	12	
XKB18N	18	12	
XKB17N	17	12	
XKB16N	16	12	
XKB15N	15	12	
XKB14N	14	12	
XKB13N	13	12	
XKB12N	12	12	
XKB11N	11	12	
XKB10N	10	12	
XKB9N	09	12	
XKB8N	08	12	
XKB7N	07	12	
XKB6N	06	12	
XKB5N	05	12	
XKB4N	04	12	
XKB3N	03	12	
XKB2N	02	12	
XKB1N	01	12	

**PREMIUM 135° 150A-SP SPLIT POINT**

JOBBERLS LETTER DRILL BIT

Line: 1477-00



PART NUMBER	SIZE	QTY/BX	LIST PRICE
XJB-A	A	1	
XJB-B	B	1	
XJB-C	C	1	
XJB-D	D	1	
XJB-E	E	1	
XJB-F	F	1	
XJB-G	G	1	
XJB-H	H	1	
XJB-I	I	1	
XJB-J	J	1	
XJB-K	K	1	
XJB-L	L	1	
XJB-M	M	1	
XJB-N	N	1	
XJB-O	O	1	
XJB-P	P	1	
XJB-Q	Q	1	
XJB-R	R	1	
XJB-S	S	1	
XJB-T	T	1	
XJB-U	U	1	
XJB-V	V	1	
XJB-W	W	1	
XJB-X	X	1	
XJB-Y	Y	1	
XJB-Z	Z	1	

**PREMIUM 550 COBALT HEAVY DUTY**

JOBBER DRILL BIT

Line: 1478-00



PART NUMBER	SIZE	QTY/BX	LIST PRICE
XGB01	1/64	1	
XGB02	1/32	1	
XGB03	3/64	1	
XGB04	1/16	1	
XGB05	5/64	1	
XGB06	3/32	1	
XGB07	7/64	1	
XGB08	1/8	1	
XGB09	9/64	1	
XGB10	5/32	1	
XGB11	11/64	1	
XGB12	3/16	1	
XGB13	13/64	1	
XGB14	7/32	1	
XGB15	15/64	1	
XGB16	1/4	1	
XGB17	17/64	1	
XGB18	9/32	1	
XGB19	19/64	1	
XGB20	5/16	1	
XGB21	21/64	1	
XGB22	11/32	1	
XGB23	23/64	1	
XGB24	3/8	1	
XGB25	25/64	1	
XGB26	13/32	1	
XGB27	27/64	1	
XGB28	7/16	1	
XGB29	29/64	1	
XGB30	15/32	1	
XGB31	31/64	1	
XGB32	1/2	1	

**GLOBAL COBALT**

JOBBER DRILL BIT

Line: 1478-10



PART NUMBER	SIZE	QTY/BX	LIST PRICE
ATD04	1/16	12	
ATD05	5/64	12	
ATD06	3/32	12	
ATD07	7/64	12	
ATD08	1/8	12	
ATD09	9/64	12	
ATD10	5/32	12	
ATD11	11/64	12	
ATD12	3/16	12	
ATD13	13/64	12	
ATD14	7/32	12	
ATD15	15/64	12	
ATD16	1/4	12	
ATD17	17/64	12	
ATD18	9/32	12	
ATD19	19/64	12	
ATD20	5/16	6	
ATD21	21/64	6	
ATD22	11/32	6	
ATD23	23/64	6	
ATD24	3/8	6	
ATD25	25/64	6	
ATD26	13/32	6	
ATD27	27/64	6	
ATD28	7/16	6	
ATD29	29/64	6	
ATD30	15/32	6	
ATD31	31/64	6	
ATD32	1/2	6	

**550 COBALT NUMBER 135° SPLIT POINT**

JOBBER DRILL BIT

Line: 1478-11



PART NUMBER	SIZE	QTY/BX	LIST PRICE
ATE59	59	12	
ATE58	58	12	
ATE57	57	12	
ATE56	56	12	
ATE55	55	12	
ATE54	54	12	
ATE53	53	12	
ATE52	52	12	
ATE51	51	12	
ATE50	50	12	
ATE49	49	12	
ATE48	48	12	
ATE47	47	12	
ATE46	46	12	
ATE45	45	12	
ATE44	44	12	
ATE43	43	12	
ATE42	42	12	
ATE41	41	12	
ATE40	40	12	
ATE39	39	12	
ATE38	38	12	
ATE37	37	12	
ATE36	36	12	
ATE35	35	12	
ATE34	34	12	
ATE33	33	12	
ATE32	32	12	
ATE31	31	12	
ATE30	30	12	
ATE29	29	12	
ATE28	28	12	
ATE27	27	12	
ATE26	26	12	
ATE25	25	12	
ATE24	24	12	
ATE23	23	12	
ATE22	22	12	
ATE21	21	12	
ATE20	20	12	
ATE19	19	12	
ATE18	18	12	
ATE17	17	12	
ATE16	16	12	

(continued...)

### 550 COBALT NUMBER 135° SPLIT POINT (cont.)

JOBBER DRILL BIT

Line: 1478-11



PART NUMBER	SIZE	QTY/BX	LIST PRICE
ATE15	15	12	
ATE14	14	12	
ATE13	13	12	
ATE12	12	12	
ATE11	11	12	
ATE10	10	12	
ATE09	9	12	
ATE08	8	12	
ATE07	7	12	
ATE06	6	12	
ATE05	5	12	
ATE04	4	12	
ATE03	3	12	
ATE02	2	12	
ATE01	1	12	

### 550 COBALT LETTER 135° SPLIT POINT

JOBBER DRILL BIT

Line: 1478-12



PART NUMBER	SIZE	QTY/BX	LIST PRICE
ATFA	A	12	
ATFB	B	12	
ATFC	C	12	
ATFD	D	12	
ATFE	E	12	
ATFF	F	12	
ATFG	G	12	
ATFH	H	12	
ATFI	I	12	
ATFJ	J	12	
ATFK	K	12	
ATFL	L	12	
ATFM	M	12	
ATFN	N	6	
ATFO	O	6	
ATFP	P	6	
ATFQ	Q	6	
ATFR	R	6	
ATFS	S	6	
ATFT	T	6	
ATFU	U	6	
ATFV	V	6	
ATFW	W	6	
ATFX	X	6	
ATFY	Y	6	
ATFZ	Z	6	

### 135° HI-SPEED SHORT HEAVY DUTY SPLIT POINT

DRILL BIT - PREMIUM

Line: 1479-00



PART NUMBER	SIZE	QTY/BX	LIST PRICE
XAB03	3/64	12	
XAB04	1/16	12	
XAB05	5/64	12	
XAB06	3/32	12	
XAB07	7/64	12	
XAB08	1/8	12	
XAB09	9/64	12	
XAB10	5/32	12	
XAB11	11/64	12	
XAB12	3/16	12	
XAB13	13/64	12	
XAB14	7/32	12	
XAB15	15/64	12	
XAB16	1/4	12	
XAB17	17/64	12	
XAB18	9/32	12	
XAB19	19/64	6	
XAB20	5/16	6	
XAB21	21/64	6	
XAB22	11/32	6	
XAB23	23/64	6	
XAB24	3/8	6	
XAB25	25/64	1	
XAB26	13/32	1	
XAB27	27/64	1	
XAB28	7/16	1	
XAB29	29/64	1	
XAB30	15/32	1	
XAB31	31/64	1	
XAB32	1/2	1	

### 135° HI-SPEED SHORT NUMBER HEAVY DUTY

DRILL BIT

Line: 1480-00



PART NUMBER	SIZE	QTY/BX	LIST PRICE
XLB60N	60	12	
XLB59N	59	12	
XLB58N	58	12	
XLB57N	57	12	
XLB56N	56	12	
XLB55N	55	12	
XLB54N	54	12	
XLB53N	53	12	
XLB52N	52	12	
XLB51N	51	12	
XLB50N	50	12	
XLB49N	49	12	
XLB48N	48	12	
XLB47N	47	12	
XLB46N	46	12	
XLB45N	45	12	
XLB44N	44	12	
XLB43N	43	12	
XLB42N	42	12	
XLB41N	41	12	
XLB40N	40	12	
XLB39N	39	12	
XLB38N	38	12	
XLB37N	37	12	
XLB36N	36	12	
XLB35N	35	12	
XLB34N	34	12	
XLB33N	33	12	
XLB32N	32	12	
XLB31N	31	12	
XLB30N	30	12	
XLB29N	29	12	
XLB28N	28	12	
XLB27N	27	12	
XLB26N	26	12	
XLB25N	25	12	
XLB24N	24	12	
XLB23N	23	12	
XLB22N	22	12	
XLB21N	21	12	
XLB20N	20	12	
XLB19N	19	12	
XLB18N	18	12	

### 135° HI-SPEED SHORT NUMBER HEAVY DUTY (cont.)

DRILL BIT

Line: 1480-00



PART NUMBER	SIZE	QTY/BX	LIST PRICE
XLB17N	17	12	
XLB16N	16	12	
XLB15N	15	12	
XLB14N	14	12	
XLB13N	13	12	
XLB12N	12	12	
XLB11N	11	12	
XLB10N	10	12	
XLB9N	09	12	
XLB8N	08	12	
XLB7N	07	12	
XLB6N	06	12	
XLB5N	05	12	
XLB4N	04	12	
XLB3N	03	12	
XLB2N	02	12	
XLB1N	01	12	

### 135° HI-SPEED STUBBY

FRACTIONAL DRILL BIT - GLOBAL

Line: 1480-01



PART NUMBER	SIZE	QTY/BX	LIST PRICE
ASX04	1/16	12	
ASX05	5/64	12	
ASX06	3/32	12	
ASX07	7/64	12	
ASX08	1/8	12	
ASX09	9/64	12	
ASX10	5/32	12	
ASX11	11/64	12	
ASX12	3/16	12	
ASX13	13/64	12	
ASX14	7/32	12	
ASX15	15/64	12	
ASX16	1/4	12	
ASX17	17/64	12	
ASX18	9/32	12	
ASX19	19/64	12	
ASX20	5/16	6	
ASX21	21/64	6	
ASX22	11/32	6	
ASX23	23/64	6	
ASX24	3/8	6	
ASX25	25/64	6	

(continued...)



### 135° HI-SPEED STUBBY (cont.)

FRACTIONAL DRILL BIT - GLOBAL

Line: 1480-01



PART NUMBER	SIZE	QTY/BX	LIST PRICE
ASX26	13/32	6	
ASX27	27/64	6	
ASX28	7/16	6	
ASX29	29/64	6	
ASX30	15/32	6	
ASX31	31/64	6	
ASX32	1/2	6	

### 135° HI-SPEED STUBBY

LETTER DRILL BIT

Line: 1480-03



PART NUMBER	SIZE	QTY/BX	LIST PRICE
ASZA	A	12	
ASZB	B	12	
ASZC	C	12	
ASZD	D	12	
ASZE	E	12	
ASZF	F	12	
ASZG	G	12	
ASZH	H	12	
ASZI	I	12	
ASZJ	J	12	
ASZK	K	12	
ASZL	L	12	
ASZM	M	12	
ASZN	N	12	
ASZO	O	12	
ASZP	P	6	
ASZQ	Q	6	
ASZR	R	6	
ASZS	S	6	
ASZT	T	6	
ASZU	U	6	
ASZV	V	6	
ASZW	W	6	
ASZX	X	6	
ASZY	Y	6	
ASZZ	Z	6	

### PREMIUM #280UB 135° S&D 1/2" SHANK

DRILL BIT

Line: 1481-00



PART NUMBER	SIZE	QTY/BX	LIST PRICE
WWB33	33/64	1	
WWB34	17/32	1	
WWB35	35/64	1	
WWB36	9/16	1	
WWB37	37/64	1	
WWB38	19/32	1	
WWB39	39/64	1	
WWB40	5/8	1	
WWB41	41/64	1	
WWB42	21/32	1	
WWB43	43/64	1	
WWB44	11/16	1	
WWB45	45/64	1	
WWB46	23/32	1	
WWB47	47/64	1	
WWB48	3/4	1	
WWB49	49/64	1	
WWB50	25/32	1	
WWB51X	51/64	1	
WWB52	13/16	1	
WWB53	53/64	1	
WWB54	27/32	1	
WWB55	55/64	1	
WWB56	7/8	1	
WWB57	57/64	1	
WWB58	29/32	1	
WWB59	59/64	1	
WWB60	15/16	1	
WWB61	61/64	1	
WWB62	31/32	1	
WWB63	63/64	1	
WWB64	1	1	
WWB66	1 1/32	1	
WWB68	1 1/16	1	
WWB72	1 1/8	1	
WWB74	1 5/32	1	
WWB76	1 3/16	1	
WWB78	1 7/32	1	
WWB80	1 1/4	1	
WWB88	1 3/8	1	
WWB96	1 1/2	1	

**GENERAL PURPOSE 118° S&D 1/2" SHANK**

DRILL BIT

Line: 1481-01



PART NUMBER	SIZE	QTY/BX	LIST PRICE
ASW33	33/64	1	
ASW34	17/32	1	
ASW35	35/64	1	
ASW36	9/16	1	
ASW37	37/64	1	
ASW38	19/32	1	
ASW39	39/64	1	
ASW40	5/8	1	
ASW41	41/64	1	
ASW42	21/32	1	
ASW43	43/64	1	
ASW44	11/16	1	
ASW45	45/64	1	
ASW46	23/32	1	
ASW47	47/64	1	
ASW48	3/4	1	
ASW49	49/64	1	
ASW50	25/32	1	
ASW51	51/64	1	
ASW52	13/16	1	
ASW54	27/32	1	
ASW56	7/8	1	
ASW58	29/32	1	
ASW59	59/64	1	
ASW60	15/16	1	
ASW62	31/32	1	
ASW63	63/64	1	
ASW64	1	1	
ASW68	1 1/16	1	
ASW72	1 1/8	1	
ASW76	1 3/16	1	
ASW80	1 1/4	1	
ASW88	1 3/8	1	
ASW96	1 1/2	1	

**1025N 135° 1/4 SHANK**

DRILL BIT

Line: 1482-00



PART NUMBER	SIZE	QTY/BX	LIST PRICE
WXB17X	17/64	1	
WXB18	9/32	1	
WXB19X	19/64	1	
WXB20	5/16	1	
WXB21X	21/64	1	
WXB22	11/32	1	
WXB23X	23/64	1	
WXB24	3/8	1	
WXB25	25/64	1	
WXB26	13/32	1	
WXB27	27/64	1	
WXB28	7/16	1	
WXB29	29/64	1	
WXB30	15/32	1	
WXB31	31/64	1	
WXB32	1/2	1	

**#278V 135° 3/8 SHANK**

DRILL BIT

Line: 1482-01



PART NUMBER	SIZE	QTY/BX	LIST PRICE
BKH25	25/64	1	
BKH26	13/32	1	
BKH27	27/64	1	
BKH28	7/16	1	
BKH29	29/64	1	
BKH30	15/32	1	
BKH31	31/64	1	
BKH32	1/2	1	
BKH34	17/32	1	
BKH36	9/16	1	
BKH40	5/8	1	

**PREMIUM #120 HI-SPEED TAPER LENGTH**

NUMBER DRILL BIT

Line: 1485-00



PART NUMBER	SIZE	QTY/BX	LIST PRICE
WYB03	3/64	1	
WYB04	1/16	1	
WYB05	5/64	1	
WYB06	3/32	1	
WYB07	7/64	1	
WYB08	1/8	1	
WYB09	9/64	1	
WYB10	5/32	1	

(continued...)

**PREMIUM #120 HI-SPEED TAPER LENGTH (cont.)**

DRILL BIT

Line: 1485-00



PART NUMBER	SIZE	QTY/BX	LIST PRICE
WYB11	11/64	1	
WYB12	3/16	1	
WYB13	13/64	1	
WYB14	7/32	1	
WYB15	15/64	1	
WYB16	1/4	1	
WYB17	17/64	1	
WYB18	9/32	1	
WYB19	19/64	1	
WYB20	5/16	1	
WYB21	21/64	1	
WYB22	11/32	1	
WYB23	23/64	1	
WYB24	3/8	1	
WYB25	25/64	1	
WYB26	13/32	1	
WYB27	27/64	1	
WYB28	7/16	1	
WYB29	29/64	1	
WYB30	15/32	1	
WYB31	31/64	1	
WYB32	1/2	1	
WYB33	33/64	1	
WYB34	17/32	1	
WYB36	9/16	1	
WYB40	5/8	1	
WYB44	11/16	1	
WYB48	3/4	1	

**LONG BOY 12" & 18" STRAIGHT SHANK**

DRILL BIT

Line: 1486-00



PART NUMBER	SIZE	QTY/BX	LIST PRICE
ZTB0812	1/8 X 12	1	
ZTB0912	9/64 X 12	1	
ZTB1012	5/32 X 12	1	
ZTB1112	11/64 X 12	1	
ZTB1212	3/16 X 12	1	
ZTB1218	3/16 X 18	1	
ZTB1312	13/64 X 12	1	
ZTB1412	7/32 X 12	1	
ZTB1418	7/32 X 18	1	
ZTB1508	15/64 X 8	1	
ZTB1512	15/64 X 12	1	

**LONG BOY 12" & 18" STRAIGHT SHANK (cont.)**

DRILL BIT

Line: 1486-00



PART NUMBER	SIZE	QTY/BX	LIST PRICE
ZTB1608	1/4 X 8	1	
ZTB1612	1/4 X 12	1	
ZTB1618	1/4 X 18	1	
ZTB1712	17/64 X 12	1	
ZTB1812	9/32 X 12	1	
ZTB1818	9/32 X 18	1	
ZTB1912	19/64 X 12	1	
ZTB2012	5/16 X 12	1	
ZTB2018	5/16 X 18	1	
ZTB2112	21/64 X 12	1	
ZTB2212	11/32 X 12	1	
ZTB2218	11/32 X 18	1	
ZTB2312	23/64 X 12	1	
ZTB2408	3/8 X 8	1	
ZTB2412	3/8 X 12	1	
ZTB2418	3/8 X 18	1	
ZTB2512	25/64 X 12	1	
ZTB2612	13/32 X 12	1	
ZTB2618	13/32 X 18	1	
ZTB2712	27/64 X 12	1	
ZTB2812	7/16 X 12	1	
ZTB2818	7/16 X 18	1	
ZTB2912	29/64 X 12	1	
ZTB3012	15/32 X 12	1	
ZTB3018	15/32 X 18	1	
ZTB3112	31/64 X 12	1	
ZTB3208	1/2 X 8	1	
ZTB3212	1/2 X 12	1	
ZTB3218	1/2 X 18	1	
ZTB3412	17/32 X 12	1	
ZTB3418	17/32 X 18	1	
ZTB3612	9/16 X 12	1	
ZTB3618	9/16 X 18	1	
ZTB3812	19/32 X 12	1	
ZTB3818	19/32 X 18	1	
ZTB4012	5/8 X 12	1	
ZTB4018	5/8 X 18	1	
ZTB4412	11/16 X 12	1	
ZTB4812	3/4 X 12	1	

(continued...)

## HI-SPEED MULTI-STEP CONE

DRILL BIT

Line: 1486-01



PART NUMBER	SIZE	QTY/BX	LIST PRICE
AMN37807	1/8 TO 1/2	1	
AMN37811	3/16 TO 7/8	1	
AMN37810	1/4 TO 3/4	1	
AMN3780444	1/4 TO 1 3/8	1	
AMN52520	1/2 SHK 9/16-1 SIZE	1	
AMN37818	13/16 TO 1 3/8	1	

## HI-SPEED HEX CHUCK SHANK

DRILL BIT

Line: 1486-02



PART NUMBER	SIZE	QTY/BX	LIST PRICE
ATNKIT	1/16 thru 1/4 (7 piece set)	1	
ATN04	1/16 (T45404)	1	
ATN06	3/32 (T45406)	1	
ATN08	1/8 (T45408)	1	
ATN09	9/64	1	
ATN10	5/32 (T45410)	1	
ATN11	11/64	1	
ATN12	3/16 (T45412)	1	
ATN14	7/32 (T45414)	1	
ATN16	1/4 (T45416)	1	

## HI-SPEED LEFT HAND - #150L

DRILL BIT

Line: 1486-03

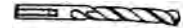

PART NUMBER	SIZE	QTY/BX	LIST PRICE
AUJ04	1/16 (44404)	6	
AUJ05	5/64	6	
AUJ06	3/32 (44406)	6	
AUJ07	7/64	6	
AUJ08	1/8 (44408)	6	
AUJ09	9/64	6	
AUJ10	5/32 (44410)	6	
AUJ11	11/64	6	
AUJ12	3/16 (44412)	6	
AUJ13	13/64	6	
AUJ14	7/32 (44414)	6	
AUJ15	15/64	6	
AUJ16	1/4 (44416)	6	
AUJ18	9/32 (44418)	6	
AUJ19	19/64	3	
AUJ20	5/16 (44420)	3	
AUJ22	11/32 (44422)	3	
AUJ24	3/8 (44424)	3	
AUJ26	13/32	3	
AUJ28	7/16 (44428)	3	
AUJ30	15/32	3	
AUJ32	1/2 (44432)	3	

## FLAT PADDLE STYLE WOOD

DRILL BIT

Line: 1486-04



PART NUMBER	SIZE	QTY/BX	LIST PRICE
BDG04	1/4	1	
BDG05	5/16	1	
BDG06	3/8	1	
BDG07	7/16	1	
BDG08	1/2	1	
BDG09	9/16	1	
BDG10	5/8	1	
BDG11	11/16	1	
BDG12	3/4	1	
BDG13	13/16	1	
BDG14	7/8	1	
BDG15	15/16	1	
BDG16	1	1	
BDG18	1 1/8	1	
BDG20	1 1/4	1	
BDG22	1 3/8	1	
BDG24	1 1/2	1	
BDG192	12 EXTENSION	1	

## BRAD POINT (BULLET) WOOD/PLASTIC

DRILL BIT

Line: 1486-05



PART NUMBER	SIZE	QTY/BX	LIST PRICE
BKT08BPH	1/8	12	
BKT10BPH	5/32	12	
BKT12BPH	3/16	12	
BKT14BPH	7/32	12	
BKT16BPH	1/4	12	
BKT18BPH	9/32	12	
BKT20BPH	5/16	12	
BKT22BPH	11/32	6	
BKT24BPH	3/8	6	
BKT26BPH	13/32	6	
BKT28BPH	7/16	6	
BKT32BPH	1/2	6	

## DOUBLE END 135° SPLIT POINT 490V

DRILL BIT

Line: 1486-06

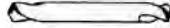

PART NUMBER	SIZE	QTY/BX	LIST PRICE
BKL06	3/32	12	
BKL07	7/64	12	
BKL08	1/8	12	
BKL09	9/64	12	
BKL10	5/32	12	
BKL12	3/16	12	
BKL14	7/32	12	
BKL16	1/4	12	
BKL10N	#10	12	
BKL11N	#11	12	
BKL20N	#20	12	
BKL30N	#30	12	

## METRIC 135° SPLIT POINT

JOBBER DRILL BIT

Line: 1486-07



PART NUMBER	SIZE	QTY/BX	LIST PRICE
BKJ0125	1.25 MM	10	
BKJ019	1.9 MM	10	
BKJ20	2.0 MM	10	
BKJ205	2.05 MM	10	
BKJ250	2.50 MM	10	
BKJ290	2.90 MM	10	
BKJ30	3.0 MM	10	
BKJ330	3.30 MM	10	
BKJ35	3.5 MM	10	
BKJ38	3.8 MM	10	
BKJ40	4.0 MM	10	
BKJ42	4.2 MM	10	
BKJ45	4.5 MM	10	
BKJ50	5.0 MM	10	
BKJ55	5.5 MM	10	
BKJ60	6.0 MM	10	
BKJ61	6.1 MM	10	
BKJ63	6.3 MM	10	
BKJ65	6.5 MM	10	
BKJ67	6.7 MM	10	
BKJ68	6.8 MM	10	
BKJ70	7.0 MM	10	
BKJ75	7.5 MM	5	
BKJ80	8.0 MM	5	
BKJ85	8.5 MM	5	
BKJ86	8.6 MM	5	
BKJ90	9.0 MM	5	
BKJ95	9.5 MM	5	
BKJ100	10.0 MM	5	
BKJ102	10.2 MM	5	
BKJ105	10.5 MM	5	
BKJ110	11.0 MM	5	
BKJ115	11.5 MM	5	
BKJ120	12.0 MM	5	
BKJ125	12.5 MM	5	
BKJ130	13.0 MM	5	

## SHIP HEAD AUGER STRAIGHT SHANK

WOOD DRILL BIT

Line: 1486-08



PART NUMBER	SIZE	QTY/BX	LIST PRICE
BKV3817	3/8 X 18	1	
BKV71617	7/16 X 18 - 5/16 HX	1	
BKV126	1/2 X 7 1/2	1	
BKV1217	1/2 X 18	1	
BKV91617	9/16 X 18 - 7/16 HX	1	
BKV586	5/8 X 7 1/2	1	
BKV5817	5/8 X 18	1	
BKV346	3/4 X 7 1/2	1	
BKV3417	3/4 X 18	1	
BKV786	7/8 X 7 1/2	1	
BKV7817	7/8 X 18	1	
BKV16	1 X 7 1/2	1	
BKV117	1 X 18	1	
BKV11417	1 1/4 X 18	1	

## GLASS/TILE SPEAR POINTED

DRILL BIT

Line: 1486-09



PART NUMBER	SIZE	QTY/BX	LIST PRICE
BKK18	1/8	2	
BKK532	5/32	2	
BKK316	3/16	2	
BKK14	1/4	2	
BKK516	5/16	2	
BKK38	3/8	2	
BKK12	1/2	1	

## LETTER HI-SPEED JOBBER DRILL SET

DRILL BIT SET AND INDEX

Line: 1487-00



PART NUMBER	SIZE	QTY/BX	LIST PRICE
WSB26L	A-Z W/CASE	1	

## METRIC HI-SPEED JOBBER DRILL SET

DRILL BIT SET AND INDEX

Line: 1488-00



PART NUMBER	SIZE	QTY/BX	LIST PRICE
WSB11M	1.0-6.0MM X 1/2MM	1	
WSB25M	1.0-13.0MM X 1/2MM	1	

## NUMBER HI-SPEED JOBBER DRILL SET

DRILL BIT SET AND INDEX

Line: 1489-00



PART NUMBER	SIZE	QTY/BX	LIST PRICE
WSB20N	61-80 W/CASE	1	
WSB60N	1-60 W/CASE	1	
WSB80N	1-80 W/CASE	1	

## FRACTION HI-SPEED JOBBER DRILL SET

DRILL BIT SET AND INDEX

Line: 1490-00



PART NUMBER	SIZE	QTY/BX	LIST PRICE
WSBHFU27	1/16-1/2 X 64/13° SPLIT POINT	1	
WSBSPM29	1/16-1/2 FLAT SHANK 135°	1	
WSBSP115	1/16-1/2 A-Z 1-60	1	
WSB12250	9/16-1 (4 PIECE S&D)	1	
WSB13F	1/16-1/4 X 64TH (44110)	1	
WSB15F	1/16-1/2 X 32ND (44120)	1	
WSB21F	1/16-3/8 X 64TH (44130)	1	
WSB29CB	1/16/1/2 (29 PIECE COBALT)	1	
WSB29F	1/16-1/2 X 64TH (43380)	1	
WSB29LH	1/16-1/2 LEFT HAND (17 PIECE)	1	
WSB92400	9/16-1 X 1/16 (8PC S&D)	1	

## FRACTION HI-SPEED POWER DRILL SET

DRILL BIT SET AND INDEX

Line: 1491-00

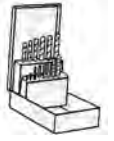

PART NUMBER	SIZE	QTY/BX	LIST PRICE
WSB29FP	1/16-1/2 BY 64THS	1	

## GREENFIELD TAP & DRILL SET

DRILL BIT SET WITH METAL INDEX

Line: 1491-01



PART NUMBER	SIZE	QTY/BX	LIST PRICE
APJ52541	HM-18 (18PIECE W/METRIC SIZES)	1	
APJ52580	#6 - 1/2 UNC (18 PIECE)	1	
APJ68	#4-1/2 NC (12910)	1	
APJ69939	6/32 THRU 1/4-20	1	

## DRILL INDEX CASES ONLY

Line: 1492-00



PART NUMBER	SIZE	QTY/BX	LIST PRICE
WTBA33	1/2-1 S&D STAND	1	
WTB11M	M1.0 TO M6.0 METRIC	1	
WTB13HD	1/16-1/4 BY 64THS	1	
WTB20H	61-80	1	
WTB21H	1/16-3/8	1	
WTB25M	M1.0 TO M13.0 METRIC	1	
WTB26H	A-Z	1	
WTB60H	1-60	1	
WTB80H	1-80	1	
WTB13H	1/16 TO 1/4	1	
WTB15H	1/16 TO 1/2 (15PC)	1	
WTB29H	1/16 TO 1/2 (29PC)	1	

## MASTER DRILL COUNTER DISPENSER

Line: 1492-05



PART NUMBER	SIZE	QTY/BX	LIST PRICE
WTBFRAC	1/16-1/2 X 64THS 3DR	1	
WTB5DRWNO	1 TO 60 (5 DRAWERS)	1	

## HI-SPEED DRILL & COUNTERSINK PLAIN #217

DRILL BIT

Line: 1493-00



PART NUMBER	SIZE	QTY/BX	LIST PRICE
WPB415-00	00	1	
WPB415-0	0	1	
WPB415-1	1	1	
WPB415-2	2	1	
WPB415-3	3	1	
WPB415-4	4	1	
WPB415-5	5	1	
WPB145-6	6	1	
WPB415-7	7	1	
WPB415-8	8	1	

## HI-SPEED DRILL & COUNTERSINK BELL #217B

DRILL BIT

Line: 1494-00



PART NUMBER	SIZE	QTY/BX	LIST PRICE
WRB415B-11	11	1	
WRB415B-12	12	1	
WRB415B-13	13	1	
WRB415B-14	14	1	
WRB145B-15	15	1	
WRB415B-16	16	1	
WRB415B-17	17	1	
WRB145B-18	18	1	

## #800 SCREW EXTRACTOR SETS WITH CASE

DRILL BIT

Line: 1496-00



PART NUMBER	SIZE	QTY/BX	LIST PRICE
XCB515	#18 15 5PC #1-5	1	
XCB516	#18 16 6PC #1-6	1	
XCB517	#18 23 3PC #4-6	1	
XCB518	#18 18 4PC #6-9	1	
XCB521	#18 21 4PC 5-7 1/2	1	
XCB819	#1 THRU #9 9 PC	1	

## #800 LITTLE GIANT SCREW EXTRACTOR

DRILL BIT

Line: 1497-00



PART NUMBER	SIZE	QTY/BX	LIST PRICE
YHB001	#01 (#8 - 1/4)	1	
YHB002	#02 (#12 - 5/16)	1	
YHB003	#03 (5/16 - 7/16)	1	
YHB004	#04 (7/16 - 9/16)	1	
YHB005	#05 (9/16 - 3/4)	1	
YHB525	5-1/4 (11/16 - 15/16)	1	
YHB006	#06 (3/4 - 1")	1	
YHB637	6-3/8 (15/16 - 1 1/8)	1	
YHB007	#07 (1" - 1 3/8)	1	
YHB750	07-1/2 (1 1/8 - 1 1/2)	1	
YHB008	#08 (1 3/8 - 1 3/4)	1	
YHB009	#09 (1 3/4 - 2 1/8)	1	
YHB010	#10 (2 1/8 - 2 1/2)	1	
YHB011	#11 (2 1/2 - 3 RANGE)	1	
YHB012	#12 (3 - 3 1/2 RANGE)	1	

### SPIRAL FLUTE FRAME REAMER #50UB

DRILL BIT

Line: 1497-03



PART NUMBER	SIZE	QTY/BX	LIST PRICE
BKW50UB08	1/2 X 1/2 SHANK	1	
BKW50UB09	9/16 X 1/2 SHANK	1	
BKW50UB10	5/8 X 1/2 SHANK	1	
BKW50UB11	11/16 X 1/2 SHANK	1	
BKW50UB12	3/4 X 1/2 SHANK	1	
BKW50UB13	13/16 X 1/2 SHANK	1	
BKW50UB14	7/8 X 1/2 SHANK	1	
BKW50UB15	15/16 X 1/2 SHANK	1	
BKW50UB16	1 X 1/2 SHANK	1	
BKW50UB17	1 1/16 X 1/2 SHANK	1	
BKW50UB18	1 1/8 X 3/4 SHANK	1	
BKW50UB19	1 3/16 X 3/4 SHANK	1	
BKW50UB20	1 1/4 X 1/2 SHANK	1	
BKW50UB21	1 5/16 X 3/4 SHANK	1	

### #213 HI-SPEED 60° CENTER REAMER COUNTERSINKS

DRILL BIT

Line: 1498-00



PART NUMBER	SIZE	QTY/BX	LIST PRICE
XDB0460	1/4 (213 56816)	1	
XDB0660	3/8 (213 56818)	1	
XDB8-460	1/2 X 1/4 (213 56819)	1	
XDB8-660	1/2 X 3/8 (213 56820)	1	
XDB1060	5/8 (213 56822)	1	
XDB1260	3/4 (213 56824)	1	

### #213 HI-SPEED 82° CENTER REAMER COUNTERSINKS

DRILL BIT

Line: 1499-00



PART NUMBER	SIZE	QTY/BX	LIST PRICE
XDB0482	1/4 (213 56836)	1	
XDB0682	3/8 (213 56838)	1	
XDB8-482	1/2 X 1/4 (213 56839)	1	
XDB8-682	1/2 X 3/8 (213 56840)	1	
XDB1082	5/8 (213 56842)	1	
XDB1282	3/4 (213 56844)	1	

### #209SF 60° SINGLE FLUTE HS COUNTERSINKS

DRILL BIT

Line: 1500-00



PART NUMBER	SIZE	QTY/BX	LIST PRICE
XEB0460	1/4	1	
XEB0660	3/8	1	
XEB0860	1/2	1	
XEB1260	3/4	1	
XEB1660	1	1	

### #209SF 82° SINGLE FLUTE HS COUNTERSINKS

DRILL BIT

Line: 1501-00



PART NUMBER	SIZE	QTY/BX	LIST PRICE
XEB0482	1/4	1	
XEB0682	3/8	1	
XEB0882	1/2	1	
XEB1282	3/4	1	
XEB1682	1	1	

### #209F 60° 3-FLUTE HS MACH COUNTERSINKS

DRILL BIT

Line: 1502-00



PART NUMBER	SIZE	QTY/BX	LIST PRICE
XFB0860	1/2 (209F 56780)	1	
XFB1060	5/8	1	
XFB1260	3/4	1	
XFB1460	7/8	1	
XFB1660	1	1	

### #209F 82° 3-FLUTE HS MACH COUNTERSINKS

DRILL BIT

Line: 1503-00



PART NUMBER	SIZE	QTY/BX	LIST PRICE
XFB0882	1/2 (4 FLUTE)	1	
XFB1082	5/8	1	
XFB1282	3/4 (4 FLUTE)	1	
XFB1482	7/8	1	
XFB1682	1 (FLUTE)	1	

### MASONRY ECONOMY REGULAR SPIRAL

DRILL BIT

Line: 1503-25



PART NUMBER	SIZE	QTY/BX	LIST PRICE
ANW03128	3/16 X 4	1	
ANW04128	1/4 X 4	1	
ANW05128	5/16 X 4	1	
ANW06128	3/8 X 4	1	
ANW06192	3/8 X 6	1	



### MASONRY REGULAR SPIRAL - CARBIDE TIP

DRILL BIT

Line: 1504-00



PART NUMBER	SIZE	QTY/BX	LIST PRICE
XMB08	1/8 X 3	1	
XMB10	5/32 X 3	1	
XMB10-6	5/32 X 6	1	
XMB12	3/16 X 4	1	
XMB12-6	3/16 X 6	1	
XMB16-4	1/4 X 4	1	
XMB16-6	1/4 X 6	1	
XMB20-4	5/16 X 4	1	
XMB20-6	5/16 X 6	1	
XMB24-4	3/8 X 4	1	
XMB24-6	3/8 X 6	1	
XMB28-16	7/16 X 4	1	
XMB28-24	7/16 X 6	1	
XMB32-16	1/2 X 4	1	
XMB32-24	1/2 X 6	1	
XMB36	9/16 X 6	1	
XMB40	5/8 X 6	1	
XMB44	11/16 X 6	1	
XMB48	3/4 X 6	1	
XMB56	7/8 X 6	1	
XMB64	1 X 6	1	
XMB72	1 1/8 X 6	1	
XMB80	1 1/4 X 1/2 X 6	1	
XMB96	1 1/2 X 1/2 X 6	1	

### MASONRY FAST SPIRAL - CARBIDE TIP

DRILL BIT

Line: 1505-00



PART NUMBER	SIZE	QTY/BX	LIST PRICE
XNB08	1/8 X 3	1	
XNB11	11/64 X 4	1	
XNB12	3/16 X 4	1	
XNB16-4	1/4 X 4	1	
XNB16-6	1/4 X 6	1	
XNB20-4	5/16 X 4	1	
XNB20-6	5/16 X 6	1	
XNB24-4	3/8 X 4	1	
XNB24-6	3/8 X 6	1	
XNB28-24	7/16 X 6	1	
XNB32-16	1/2 X 4	1	
XNB32-24	1/2 X 6	1	
XNB36	9/16 X 6	1	
XNB40	5/8 X 6	1	
XNB44	11/16 X 6	1	
XNB48	3/4 X 6	1	
XNB56	7/8 X 6	1	
XNB64	1 X 6	1	

### MASONRY LONG REGULAR SPIRAL - CARBIDE TIP

DRILL BIT

Line: 1506-00



PART NUMBER	SIZE	QTY/BX	LIST PRICE
XPB1612	1/4 X 12	1	
XPB1618	1/4 X 18	1	
XPB2012	5/16 X 12	1	
XPB2018	5/16 X 18	1	
XPB2412	3/8 X 12	1	
XPB2418	3/8 X 18	1	
XPB2812	7/16 X 12	1	
XPB2818	7/16 X 18	1	
XPB3212	1/2 X 12	1	
XPB3218	1/2 X 18	1	
XPB4012	5/8 X 12	1	
XPB4018	5/8 X 18	1	
XPB4812	3/4 X 12	1	
XPB4818	3/4 X 18	1	
XPB5612	7/8 X 12	1	
XPB5618	7/8 X 18	1	
XPB6412	1 X 12	1	
XPB6418	1 X 18	1	

# MASONRY SDS ROTARY HAMMER DRILL BITS

Line: 1507-01



PART NUMBER	SIZE	QTY/BX	LIST PRICE
BKRJHSDS-400A	5/32 X 4 X 2	1	
BKRJHSDS-400B	5/32 X 6 X 4	1	
BKRJHSDS-401	3/16 X 4 X 2	1	
BKRJHSDS-401A	3/16 X 6 X 4	1	
BKRJHSDS-401B	3/16 X 9 X 7	1	
BKRJHSDS-401G	3/16 X 12 X 10	1	
BKRJHSDS-401C	7/32 X 6 X 4	1	
BKRJHSDS-401D	7/32 X 9 X 7	1	
BKRJHSDS-401F	7/32 X 16 X 14	1	
BKRJHSDS-402	1/4 X 4 X 2	1	
BKRJHSDS-403A	1/4 X 8 X 6	1	
BKRJHSDS-403B	1/4 X 12 X 10	1	
BKRJHSDS-403C	1/4 X 18 X 16	1	
BKRJHSDS-404	9/32 X 4 X 2	1	
BKRJHSDS-405	9/32 X 6 X 4	1	
BKRJHSDS-406	5/16 X 4 X 2	1	
BKRJHSDS-408A	5/16 X 12 X 10	1	
BKRJHSDS-410	3/8 X 9 X 7	1	
BKRJHSDS-412	3/8 X 18 X 16	1	
BKRJHSDS-412A	3/8 X 24 X 21	1	
BKRJHSDS-413	7/16 X 6 X 4	1	
BKRJHSDS-414	7/16 X 12 X 10	1	
BKRJHSDS-416	1/2 X 8 X 6	1	
BKRJHMM300A	1/2 X 13 X 8 MAX	1	
BKRJHSDS-418A	1/2 X 24 X 22	1	
BKRJHSDS-420A	9/16 X 18 X 16	1	
BKRJHMM300	5/8 X 13 X 8 MAX	1	
BKRJHSDS-423	5/8 X 12 X 10	1	
BKRJHSDS-424	5/8 X 18 X 16	1	
BKRJHSDS-424A	5/8 X 24 X 21	1	
BKRJHSDS-426	11/16 X 9 X 7	1	
BKRJHSDS-427	3/4 X 6 X 4	1	
BKRJHSDS-428	3/4 X 8 X 6	1	
BKRJHMM303	3/4 X 12 X 8 MAX	1	
BKRJHMM304	3/4 X 18 X 13 3/8 MAX	1	
BKRJHSDS-430	3/4 X 18 X 16	1	
BKRJHMM305	3/4 X 24 X 18 7/8 MAX	1	
BKRJHSDS-431	27/32 X 6 X 4	1	
BKRJHMM309	7/8 X 13 X 8 MAX	1	
BKRJHSDS-433	7/8 X 18 X 16	1	
BKRJHMM312	1 X 13 X 8 MAX	1	
BKRJHSDS-435	1 X 18 X 16	1	
BKRJHMM314	1 X 21 X 16 MAX	1	
BKRJHSDS-436	1 1/8 X 18 X 16	1	
BKRJHSDS-437	1 1/4 X 18 X 16	1	

# GROO-V-TIP MULTI PURPOSE AG/STL

DRILL BIT

Line: 1507-05



PART NUMBER	SIZE	QTY/BX	LIST PRICE
CDJGRTKIT	3/16 1/2 X 6 (5 PIECE KIT)	1	
CDJGRT33	3/16 X 3 X 1 7/8	1	
CDJGRT34	3/16 X 4 X 2 3/8	1	
CDJGRT36	3/16 X 6 X 5 3/8	1	
CDJGRT38	3/16 X 8 X 6	1	
CDJGRT44	1/4 X 4 X 2 1/4	1	
CDJGRT46	1/4 X 6 X 3 3/4	1	
CDJGRT48	1/4 X 8 X 6	1	
CDJGRT54	5/16 X 4 X 2 1/2	1	
CDJGRT56	5/16 X 6 X 4	1	
CDJGRT64	3/8 X 6 X 2 1/2	1	
CDJGRT66	3/8 X 6 X 4	1	
CDJGRT76	7/16 X 6 X 4	1	
CDJGRT86	1/2 X 6 X 4	1	
CDJGRT96	9/16 X 6 X 4	1	
CDJGRT106	5/8 X 6 X 4	1	
CDJGRT116	11/16 X 6 X 4	1	
CDJGRT126	3/4 X 6 X 4	1	
CDJGRT146	7/8 X 6 X 4	1	
CDJGRT166	1 X 6 X 4	1	

# UNIPLUS CERAMIC/MASONRY

DRILL BIT

Line: 1507-10



PART NUMBER	SIZE	QTY/BX	LIST PRICE
BDV1JP	5/32 X 3 1/8	1	
BDV2JP	3/16 X 3 1/2	1	
BDV3JP	1/4 X 4 1/8	1	
BDV5JP	5/16 X 4 3/4	1	
BDV6JP	3/8 X 6	1	
BDV7JP	1/2 X 6 3/4	1	



**CALL - 1 (800) 723-2826**

**CALL: (800) 723-2826**

### 5305-5303 HI-SPEED GH3 TAPER TAPS

DRILL BIT

Line: 1508-00



PART NUMBER	SIZE	QTY/BX	LIST PRICE
XTB00S	0/80	1	
XTB11U	1/64	1	
XTB11S	1/72	1	
XTB22U	2/56	1	
XTB22S	2/64	1	
XTB33U	3/48	1	
XTB33S	3/56	1	
XTB44C	4/36	1	
XTB44U	4/40	1	
XTB44S	4/48	1	
XTB55U	5/40	1	
XTB66U	6/32	1	
XTB66S	6/40	1	
XTB88U	8/32	1	
XTB88S	8/36	1	
XTB03U	10/24	1	
XTB03S	10/32	1	
XTB21U	12/24	1	
XTB21S	12/28	1	
XTB04U	1/4-20	1	
XTB04S	1/4-28	1	
XTB05U	5/16-18	1	
XTB05S	5/16-24	1	
XTB06U	3/8-16	1	
XTB06S	3/8-24	1	
XTB07U	7/16-14	1	
XTB07S	7/16-20	1	
XTB08U	1/2-13	1	
XTB08S	1/2-20	1	
XTB09U	9/16-12	1	
XTB09S	9/16-18	1	
XTB10U	5/8-11	1	
XTB10S	5/8-18	1	
XTB10ULH	5/8-11 LEFT HAND	1	
XTB12U	3/4-10	1	
XTB12S	3/4-16	1	
XTB12ULH	3/4-10 LEFT HAND	1	
XTB14U	7/8-9	1	
XTB14S	7/8-14	1	
XTB16U	1-8	1	
XTB16S	1-14	1	
XTB18U	1 1/8-7	1	
XTB18S	1 1/8-12	1	

(continued...)

### 5305-5303 HI-SPEED GH3 TAPER TAPS (cont.)

DRILL BIT

Line: 1508-00



PART NUMBER	SIZE	QTY/BX	LIST PRICE
XTB20U	1 1/4-7	1	
XTB20S	1 1/4-12	1	
XTB222U	1 3/8-6	1	
XTB24U	1 1/2-6	1	
XTB24S	1 1/2-12	1	
XTB32S	2-12	1	

### 5305-5303 HI-SPEED GH3 PLUG TAPS

DRILL BIT

Line: 1509-00



PART NUMBER	SIZE	QTY/BX	LIST PRICE
XUB00S	0/80	1	
XUB11U	1/64	1	
XUB11S	1/72	1	
XUB22U	2/56	1	
XUB22S	2/64	1	
XUB33U	3/48	1	
XUB33S	3/56	1	
XUB44U	4/40	1	
XUB44S	4/48	1	
XUB55U	5/40	1	
XUB55S	5/44	1	
XUB66U	6/32	1	
XUB66S	6/40	1	
XUB66U2FL	6/32 (2 FLUTE)	1	
XUB88U	8/32	1	
XUB88S	8/36	1	
XUB88U2FL	8/32 (2 FLUTE)	1	
XUB03U	10/24	1	
XUB03S	10/32	1	
XUB03S2FL	10/32 (2 FLUTE)	1	
XUB21U	12/24	1	
XUB21S	12/28	1	
XUB04U	1/4-20	1	
XUB04S	1/4-28	1	
XUB04U-LH	1/4-20 LEFT HAND	1	
XUB04U2FL	1/4-20 (2 FLUTE)	1	
XUB04S2FL	1/4-28 (2 FLUTE)	1	
XUB05U	5/16-18	1	
XUB05S	5/16-24	1	
XUB05U2FL	5/16-18 (2 FLUTE)	1	
XUB06U	3/8-16	1	
XUB06S	3/8-24	1	

(continued...)

**5305-5303 HI-SPEED GH3 PLUG TAPS (cont.)**

DRILL BIT

Line: 1509-00



PART NUMBER	SIZE	QTY/BX	LIST PRICE
XUB07U	7/16-14	1	
XUB07S	7/16-20	1	
XUB08U	1/2-13	1	
XUB08S	1/2-20	1	
XUB09U	9/16-12	1	
XUB09S	9/16-18	1	
XUB09SLH	9/16-18 LEFT HAND	1	
XUB10U	5/8-11	1	
XUB10S	5/8-18	1	
XUB12U	3/4-10	1	
XUB12S	3/4-16	1	
XUB12ULH	3/4-10 LEFT HAND	1	
XUB14U	7/8-9	1	
XUB14S	7/8-14	1	
XUB16U	1-8	1	
XUB16S	1-14	1	
XUB1612S	1-12	1	
XUB18U	1 1/8-7	1	
XUB18S	1 1/8-12	1	
XUB20U	1 1/4-7	1	
XUB20S	1 1/4-12	1	
XUB222U	1 3/8-6	1	
XUB222S	1 3/8-12	1	
XUB222UN8	1 3/8-8	1	
XUB24U	1 1/2-6	1	
XUB24S	1 1/2-12	1	
XUB226UN8	1 5/8-8	1	

**5305-5303 HI-SPEED GH3 BOTTOM TAPS**

DRILL BIT

Line: 1510-00



PART NUMBER	SIZE	QTY/BX	LIST PRICE
XVB00S	0/80	1	
XVB11U	1/64	1	
XVB11S	1/72	1	
XVB22U	2/56	1	
XVB22S	2/64	1	
XVB33U	3/48	1	
XVB33S	3/56	1	
XVB44C	4/36	1	
XVB44U	4/40	1	
XVB44S	4/48	1	
XVB55U	5/40	1	
XVB55S	5/44	1	

(continued...)

**5305-5303 HI-SPEED GH3 BOTTOM TAPS (cont.)**

DRILL BIT

Line: 1510-00



PART NUMBER	SIZE	QTY/BX	LIST PRICE
XVB66U	6/32	1	
XVB66S	6/40	1	
XVB88U	8/32	1	
XVB88S	8/36	1	
XVB03U	10/24	1	
XVB03S	10/32	1	
XVB21U	12/24	1	
XVB21S	12/28	1	
XVB04U	1/4-20	1	
XVB04S	1/4-28	1	
XVB05U	5/16-18	1	
XVB05S	5/16-24	1	
XVB06U	3/8-16	1	
XVB06S	3/8-24	1	
XVB06SLH	3/8-24 LEFT HAND	1	
XVB07U	7/16-14	1	
XVB07S	7/16-20	1	
XVB08U	1/2-13	1	
XVB08S	1/2-20	1	
XVB09U	9/16-12	1	
XVB09S	9/16-18	1	
XVB10U	5/8-11	1	
XVB10S	5/8-18	1	
XVB10ULH	5/8-11 LEFT HAND	1	
XVB12U	3/4-10	1	
XVB12S	3/4-16	1	
XVB12ULH	3/4-10 LEFT HAND	1	
XVB14U	7/8-9	1	
XVB14S	7/8-14	1	
XVB16U	1-8	1	
XVB16S	1-14	1	
XVB18S	1 1/8-12	1	
XVB18U	1 1/8-7	1	
XVB20U	1 1/4-7	1	
XVB20S	1 1/4-12	1	
XVB222U	1 3/8-6	1	
XVB222UN8	1 3/8-8	1	
XVB24U	1 1/2-6	1	
XVB24S	1 1/2-12	1	
XVB24UN8	1 1/2-8	1	
XVB26UN8	1 5/8-8	1	
XVB28UN8	1 3/4-8	1	
XVB30UN8	1 7/8-8	1	

### 5305-5303 HI-SPEED GH3 B-P-T TAP SET

DRILL BIT SET

Line: 1511-00

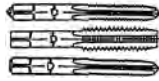

PART NUMBER	SIZE	QTY/BX	LIST PRICE
XWB00S	0/80 (15105)	1	
XWB22U	2/56 (11511)	1	
XWB22S	2/64	1	
XWB33U	3/48 (15159)	1	
XWB33S	3/56 (15169)	1	
XWB44U	4/40 (11519)	1	
XWB44S	4/48	1	
XWB55U	5/40 (11527)	1	
XWB66U	6/32 (11531)	1	
XWB66S	6/40	1	
XWB88U	8/32 (11543)	1	
XWB88S	8/36 (15304)	1	
XWB21U	12/24 (11559)	1	
XWB21S	12/28 (15393)	1	
XWB033	10/32 (11555)	1	
XWB03U	10/24 (11551)	1	
XWB04U	1/4-20 (11599)	1	
XWB04S	1/4-28 (11603)	1	
XWB05U	5/16-18 (11607)	1	
XWB05S	5/16-24 (11611)	1	
XWB06U	3/8-16 (11615)	1	
XWB06S	3/8-24 (11619)	1	
XWB07U	7/16-14 (11623)	1	
XWB07S	7/16-20 (11627)	1	
XWB08U	1/2-13 (11631)	1	
XWB08S	1/2-20 (11635)	1	
XWB09U	9/16-12 (11639)	1	
XWB09S	9/16-18 (11643)	1	
XWB10U	5/8-11 (11647)	1	
XWB10S	5/8-18 (11651)	1	
XWB11U	1/64 (15117)	1	
XWB11S	1/72 (15123)	1	
XWB12U	3/4-10 (11655)	1	
XWB12S	3/4-16 (11659)	1	
XWB14U	7/8-9 (11663)	1	
XWB14S	7/8-14 (11667)	1	
XWB16U	1-8 (11671)	1	
XWB16S	1-14 (11679)	1	
XWB18U	1 1/8-7 (11683)	1	
XWB18S	1 1/8-12	1	
XWB18UN8	1 1/8-8	1	
XWB20U	1 1/4-7 (11695)	1	
XWB20S	1 1/4-12	1	

(continued...)

### 5305-5303 HI-SPEED GH3 B-P-T TAP SET (cont.)

DRILL BIT SET

Line: 1511-00

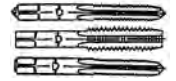

PART NUMBER	SIZE	QTY/BX	LIST PRICE
XWB20UN8	1 1/4-8	1	
XWB222U	1 3/8-6	1	
XWB22UN8	1 3/8-8	1	
XWB24U	1 1/2-6	1	

### 5301 HI-SPEED PLUG SPIRAL PT GUN TAPS

DRILL BIT

Line: 1512-00



PART NUMBER	SIZE	QTY/BX	LIST PRICE
XXB00S	0/80	1	
XXB11S	1/72	1	
XXB11U	1/64	1	
XXB22S	2/64	1	
XXB22U	2/56	1	
XXB33S	3/56	1	
XXB33U	3/48	1	
XXB44C	4/36	1	
XXB44S	4/48	1	
XXB44U	4/40	1	
XXB55U	5/40	1	
XXB66U	6/32 (13232)	1	
XXB66S	6/40	1	
XXB88U	8/32 (13242)	1	
XXB88S	8/36	1	
XXB03U	10/24 (13251)	1	
XXB03S	10/32 (13257)	1	
XXB21U	12/24 (13362)	1	
XXB21S	12/28	1	
XXB04U	1/4-20 (13270)	1	
XXB04S	1/4-28 (13280)	1	
XXB05U	5/16-18 (13291)	1	
XXB05S	5/16-24 (13300)	1	
XXB06U	3/8-16 (13307)	1	
XXB06S	3/8-24 (13313)	1	
XXB07U	7/16-14 (13319)	1	
XXB07S	7/16-20	1	
XXB08U	1/2-13 (13328)	1	
XXB08S	1/2-20 (13334)	1	
XXB10U	5/8-11 (13339)	1	
XXB10S	5/8-18	1	
XXB12U	3/4-10 (13343)	1	
XXB12S	3/4-16	1	
XXB14UX	7/8-9	1	
XXB1612S	1-12	1	
XXB16U	1-8	1	

### 5601 HI-SPEED GH3 HVY DUTY SP PT GUN TAPS

HEAVY DUTY DRILL BIT

Line: 1513-00



PART NUMBER	SIZE	QTY/BX	LIST PRICE
XYB66U	6/32 (16802)	1	
XYB88U	8/32 (16805)	1	
XYB88S	8/36	1	
XYB03U	10/24 (16807)	1	
XYB03S	10/32 (16809)	1	
XYB04U	1/4-20 (16810)	1	
XYB04S	1/4-28 (16812)	1	
XYB05U	5/(16-18 (16814)	1	
XYB05S	5/(16-24 (16816)	1	
XYB06U	3/8-(16 (16818)	1	
XYB06S	3/8-24 (16820)	1	
XYB07U	7/16-14	1	
XYB07S	7/16-20	1	
XYB08U	1/2-13 (16826)	1	
XYB08S	1/2-20	1	
XYB10U	5/8-11 (16830)	1	
XYB12U	3/4-10 (16832)	1	

### PREMIUM 5320 GROUND THD TAPER PIPE TAP

HI-SPEED DRILL BIT

Line: 1514-00



PART NUMBER	SIZE	QTY/BX	LIST PRICE
YAB01	1/16-27 (16203)	1	
YAB02	1/8-27 (11800)	1	
YAB04	1/4-18 (11802)	1	
YAB06	3/8-18 (11803)	1	
YAB08	1/2-14 (11804)	1	
YAB12	3/4-14 (11805)	1	
YAB16	1-11 1/2 (11806)	1	
YAB20	1 1/4-11 1/2	1	
YAB24	1 1/2-11 1/2	1	
YAB32	2-11 1/2	1	

### 320 CARBON TAPER PIPE TAP

DRILL BIT

Line: 1515-00



PART NUMBER	SIZE	QTY/BX	LIST PRICE
YBB02	1/8-27 (11300)	1	
YBB04	1/4-18 (11303)	1	
YBB06	3/8-18 (11305)	1	
YBB08	1/2-14 (11307)	1	
YBB12	3/4-14 (11311)	1	
YBB16	1-11 1/2 (11314)	1	
YBB20	1 1/4-11 1/2 (11317)	1	
YBB24	1 1/2-11 1/2 (11320)	1	
YBB32	2-11 1/2	1	

### 5353 GROUND THD METRIC TAPER TAP

HI-SPEED DRILL BIT

Line: 1516-00

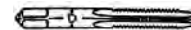

PART NUMBER	SIZE	QTY/BX	LIST PRICE
YJB2-5C	M2.5 X 0.45	1	
YJB3C	M3 X 0.5	1	
YJB3-5C	M3.5 X 0.6	1	
YJB4X	M4 X 0.7 (14757)	1	
YJB4-5C	M4.5 X 0.75	1	
YJB5C	M5 X 0.8	1	
YJB6C	M6 X 1 (14781)	1	
YJB7C	M7 X 1	1	
YJB8C	M8 X 1.25 (14797)	1	
YJB8F	M8 X 1	1	
YJB10C	M10 X 1.5 (14813)	1	
YJB10F	M10 X 1.25	1	
YJB10EF	M10 X 1.0	1	
YJB12C	M12 X 1.75 (14829)	1	
YJB12EF	M12 X 1.25	1	
YJB12F	M12 X 1.5	1	
YJB14C	M14 X 2	1	
YJB14F	M14 X 1.5	1	
YJB16C	M16 X 2	1	
YJB16F	M16 X 1.5	1	
YJB18C	M18 X 2.5	1	
YJB18EF	M18 X 1.5	1	
YJB20-2.0	M20-2.0	1	
YJB20C	M20 X 2.5	1	
YJB22C	M22 X 2.5	1	

### 5353 GROUND THD METRIC PLUG TAP

HI-SPEED DRILL BIT

Line: 1517-00



PART NUMBER	SIZE	QTY/BX	LIST PRICE
YKB2C	M2.0 X 0.4	1	
YKB2-5C	M2.5 X 0.45	1	
YKB3C	M3 X 0.5	1	
YKB3-5C	M3.5 X 0.6	1	
YKB4C	M4 X 0.7 (14758)	1	
YKB4-5C	M4.5 X 0.75	1	
YKB5C	M5 X 0.8	1	
YKB6C	M6 X 1 (11900)	1	
YKB7C	M7 X 1	1	
YKB8C	M8 X 1.25 (11901)	1	
YKB8F	M8 X 1	1	
YKB10C	M10 X 1.5 (11902)	1	
YKB10F	M10 X 1.25	1	
YKB10EFX	M10 X 1.0	1	
YKB12C	M12 X 1.75 (11903)	1	

(continued...)

### 5353 GROUND THD METRIC PLUG TAP (cont.)

HI-SPEED DRILL BIT

Line: 1517-00



PART NUMBER	SIZE	QTY/BX	LIST PRICE
YKB12EF	M12 X 1.25	1	
YKB14C	M14 X 2	1	
YKB14F	M14 X 1.5	1	
YKB16C	M16 X 2	1	
YKB16F	M16 X 1.5	1	
YKB18C	M18 X 2.5	1	
YKB18EF	M18 X 1.5	1	
YKB20-2.0	M20-2.0	1	
YKB20C	M20 X 2.5	1	
YKB22C	M22 X 2.5	1	
YKB22EF	M22 X 1.5	1	
YKB24C	M24 X 3 (14910)	1	
YKB30C	M30-3.5	1	

### 5353 GROUND THD METRIC BOTTOM TAP

HI-SPEED DRILL BIT

Line: 1518-00



PART NUMBER	SIZE	QTY/BX	LIST PRICE
YLB2-5C	M2.5 X 0.45	1	
YLB3C	M3 X 0.5	1	
YLB3-5C	M3.5 X 0.6	1	
YLB4C	M4 X 0.7 (14946)	1	
YLB4-5C	M4.5 X 0.75	1	
YLB5C	M5 X 0.8	1	
YLB6C	M6 X 1 (14948)	1	
YLB7C	M7 X 1	1	
YLB8C	M8 X 1.25 (14949)	1	
YLB8F	M8 X 1	1	
YLB10C	M10 X 1.5 (14950)	1	
YLB10F	M10 X 1.25	1	
YLB10EF	M10-1.0	1	
YLB12C	M12 X 1.75 (14951)	1	
YLB12F	M12 X 1.5	1	
YLB12EF	M12 X 1.25	1	
YLB14C	M14 X 2	1	
YLB14F	M14 X 1.5	1	
YLB16C	M16 X 2	1	
YLB16F	M16 X 1.5	1	
YLB18C	M18 X 2.5	1	
YLB18EF	M18 X 1.5	1	
YLB20-2.0	M20-2.0	1	
YLB20C	M20 X 2.5	1	
YLB22C	M22 X 2.5	1	

### 535 GT METRIC PLUG GUN TAP

HI-SPEED DRILL BIT

Line: 1519-00



PART NUMBER	SIZE	QTY/BX	LIST PRICE
YMB2C	M2.0 X 0.4	1	
YMB2-5C	M2.5 X 0.45	1	
YMB3C	M3 X 0.5	1	
YMB3-5C	M3.5 X 0.6	1	
YMB4C	M4 X 0.7	1	
YMB4-5C	M4.5 X 0.75	1	
YMB5C	M5 X 0.8	1	
YMB6C	M6 X 1	1	
YMB7C	M7 X 1	1	
YMB8C	M8 X 1.25	1	
YMB8F	M8 X 1	1	
YMB10C	M10 X 1.5	1	
YMB10F	M10 X 1.25	1	
YMB12C	M12 X 1.75	1	
YMB14C	M14 X 2	1	
YMB14F	M14 X 1.5	1	
YMB16C	M16 X 2	1	
YMB16F	M16 X 1.5	1	
YMB18C	M18 X 2.5	1	
YMB20C	M20 X 2.5	1	

### UN8 SERIES TAPER TAP #7303

HI-SPEED DRILL BIT

Line: 1521-01

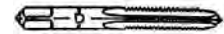

PART NUMBER	SIZE	QTY/BX	LIST PRICE
BKX18B	1 1/8-8 BOTTOM	1	
BKX18P	1 1/8-8 PLUG	1	
BKX18T	1 1/8-8 TAPER	1	
BKX20B	1 1/4-8 BOTTOM	1	
BKX20P	1 1/4-8 PLUG	1	
BKX20T	1 1/4-8 TAPER	1	
BKX22B	1 3/8-8 BOTTOM	1	
BKX22P	1 3/8-8 PLUG	1	
BKX22T	1 3/8-8 TAPER	1	
BKX24B	1 1/2-8 BOTTOM	1	
BKX24P	1 1/2-8 PLUG	1	
BKX24T	1 1/2-8 TAPER	1	
BKX32B	2-8 BOTTOM	1	
BKX32T	2-8 TAPER	1	
BKX32P	2-8 PLUG	1	
BKX40B	2 1/2-8 BOTTOM	1	
BKX40P	2 1/2-8 PLUG	1	
BKX40T	2 1/2-8 TAPER	1	

### INSERT COIL PLUG TAPS NC THD

DRILL BIT

Line: 1522-00

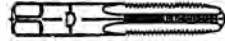

PART NUMBER	SIZE	QTY/BX	LIST PRICE
HXD3100	2/56	1	
HXD3101-04	4/40	1	
HXD3103-06	6/32	1	
HXD3104-2	8/32	1	
HXD1187-3	10/24	1	
HXD3106-1	12/24	1	
HXD1187-4	1/4-20	1	
HXD42187-5	5/16-18	1	
HXD42187-6	3/8-16	1	
HXD42187-7	7/16-14	1	
HXD42187-8	1/2-13	1	
HXD3112-9	9/16-12	1	
HXD9187-10	5/8-11	1	
HXD9187-12	3/4-10	1	
HXD8187-14	7/8-9	1	
HXD8187-16	1-8	1	
HYD3164-161	1-12	1	
HXD3117-18	1 1/8-7	1	
HXD3118-20	1 1/4-7	1	
HXD3119-22	1 3/8-6	1	
HXD3120-24	1 1/2-6	1	

### INSERT COIL PLUG TAPS NF THD

DRILL BIT

Line: 1523-00

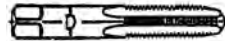

PART NUMBER	SIZE	QTY/BX	LIST PRICE
HYD3151-04	4/48	1	
HYD3152-06	6/40	1	
HYD3153-2	8/36	1	
HYD23193-3	10/32	1	
HYD1193-4	1/4-28	1	
HYD1193-5	5/16-24	1	
HYD1193-6	3/8-24	1	
HYD42193-7	7/16-20	1	
HYD42193-8	1/2-20	1	
HYD42193-9	9/16-18	1	
HYD9193-10	5/8-18	1	
HYD9193-12	3/4-16	1	
HYD3163-14	7/8-14	1	
HYD3165-16	1-14	1	
HYD4136-18	1 1/8-12	1	
HYD4137-20	1 1/4-12	1	
HYD4138-22	1 3/8-12	1	
HYD4139-24	1 1/2-12	1	

### INSERT COIL METRIC PLUG TAPS

DRILL BIT

Line: 1524-00



PART NUMBER	SIZE	QTY/BX	LIST PRICE
HZD3001-2	M2-0.4	1	
HZD3003-25	M2.5-0.45	1	
HZD3005-3	M3-.5	1	
HZD3006-35	M3.5-.6	1	
HZD3007-4	M4-.7	1	
HZD2087-5	M5 X 0.8	1	
HZD2087-6	M6 X 1.0	1	
HZD2087-7	M7 X 1.0	1	
HZD2087-8	M8 X 1.25	1	
HZD3012-8	M8-1.0	1	
HZD3013-9	M9-1.25	1	
HZD2087-10	M10 X 1.5	1	
HZD4944-10	M10 X 1.25	1	
HZD3017-10	M10-1.0	1	
HZD3018-11	M11-1.5	1	
HZD2087-12	M12 X 1.75	1	
HZD4976-12	M12 X 1.5	1	
HZD4944-12	M12 X 1.25	1	
HZD3023-12	M12-1.0	1	
HZD2087-14	M14 X 2.0	1	
HZD4976-14	M14 X 1.5	1	
HZD3029-14	M14-1.25	1	
HZD3030-14	M14-1.0	1	
HZD2087-16	M16 X 2.0	1	
HZD3034-16	M16-1.5	1	
HZD2087-18	M18 X 2.5	1	
HZD3036-18	M18-2.0	1	
HZD3037-18	M18-1.5	1	
HZD3038-20	M20-2.5	1	
HZD3039-20	M20-2.0	1	
HZD3040-20	M20-1.5	1	

### INSERT COIL SPARK PLUG TAPS

DRILL BIT

Line: 1525-00



PART NUMBER	SIZE	QTY/BX	LIST PRICE
JAD1030-14	14-1.25MM	1	



## #377 HEX RETHRADING BOLT DIE



Line: 1536-00

PART NUMBER	SIZE	QTY/BX	LIST PRICE
XZB02P	1/8-27 NPT 25/32AF	1	
XZB04S	1/4-28	1	
XZB04U	1/4-20 (24107)	1	
XZB04P	1/4-18 NPT 1 1/6AF PIPE THREAD	1	
XZB05U	5/16-18 (24112)	1	
XZB05S	5/16-24	1	
XZB06S	3/8-24	1	
XZB06U	3/8-16 (24117)	1	
XZB06P	3/8-18 NPT 1 1/4AF PIPE THREAD	1	
XZB08U	1/2-13 (24130)	1	
XZB07S	7/16-20	1	
XZB07U	7/16-14 (24123)	1	
XZB08S	1/2-20 (24133)	1	
XZB08P	1/2-14 NPT 1 7/16AF PIPE THREAD	1	
XZB09U	9/16-12	1	
XZB09S	9/16-18	1	
XZB10U	5/8-11 (24141)	1	
XZB10S	5/8-18 (24144)	1	
XZB11U	11/16-11 1 7/16AF	1	
XZB11S	11/16-16 1 7/16AF	1	
XZB12S	3/4-16 (24153)	1	
XZB12P	3/4-14 NPT 1 13/16AF PIPE THREAD	1	
XZB12U	3/4-10 (24149)	1	
XZB14U	7/8-9 (24156)	1	
XZB14S	7/8-14	1	
XZB16U	1-8 (24162)	1	
XZB16SS	1-12	1	
XZB16S	1-14	1	
XZB16P	1-11-1/2 2 13/16AF PIPE THREAD	1	
XZB18U	1 1/8-7 (24170)	1	
XZB18S	1 1/8-12	1	
XZB20U	1 1/4-7 (24176)	1	
XZB20S	1 1/4-12	1	
XZB20P	1 1/4-11 1/2 PIPE THREAD	1	
XZB22U	1 3/8-6 (24182)	1	
XZB22S	1 3/8-12	1	
XZB24U	1 1/2-6 (24187)	1	
XZB24S	1 1/2-12	1	

## 1 INCH HEX OD SOLID CARBON DIE



Line: 1537-00

PART NUMBER	SIZE	QTY/BX	LIST PRICE
YDB66U	6/32	1	
YDB88U	8/32	1	
YDB03U	10/24	1	
YDB03S	10/32	1	
YDB21UX	12/24	1	
YDB04U	1/4-20	1	
YDB04S	1/4-28	1	
YDB05U	5/16-18	1	
YDB05S	5/16-24	1	
YDB06U	3/8-16	1	
YDB06S	3/8-24	1	
YDB07U	7/16-14	1	
YDB07S	7/16-20	1	
YDB08U	1/2-13	1	
YDB08S	1/2-20	1	
YDB02	1/8 NPT PIPE THREAD	1	
YDB04	1/4 NPT PIPE THREAD	1	
YDB3C	M3-0.5	1	
YDB4C	M4-0.7	1	
YDB5C	M5-0.8	1	
YDB6C	M6-1.0	1	
YDB7C	M7-1.0	1	
YDB8C	M8-1.25	1	
YDB8F	M8-1.0	1	
YDB10C	M10-1.5	1	
YDB10F	M10-1.25	1	
YDB10EF	M10-1.0	1	
YDB12C	M12-1.75	1	
YDB12F	M12-1.5	1	
YDB12EF	M12-1.25	1	

## 1 13/16 HEX SOLID CARBON DIE



Line: 1538-00

PART NUMBER	SIZE	QTY/BX	LIST PRICE
YDB16U	1-8	1	
YDB16S	1-14	1	

## 1 5/8 HEX OD SOLID CARBON DIE



Line: 1539-00

PART NUMBER	SIZE	QTY/BX	LIST PRICE
YDB14U	7/8-9	1	
YDB14S	7/8-14	1	

## 1 7/16 HEX OD SOLID CARBON DIE



Line: 1540-00

PART NUMBER	SIZE	QTY/BX	LIST PRICE
YDB09U	9/16-12	1	
YDB09S	9/16-18	1	
YDB10U	5/8-11	1	
YDB10S	5/8-18	1	
YDB12U	3/4-10	1	
YDB12S	3/4-16	1	

## #377 HEX METRIC RETHRADING

CARBON DIE

Line: 1541-00



PART NUMBER	SIZE	QTY/BX	LIST PRICE
YNB6C	M6 X 1 (24221)	1	
YNB8C	M8 X 1.25 (24227)	1	
YNB8F	M8-1.0	1	
YNB10C	M10 X 1.5 (24229)	1	
YNB10F	M10 X 1.25	1	
YNB12C	M12 X 1.75 (24231)	1	
YNB12EF	M12 X 1.25	1	
YNB14C	M14 X 2.0	1	
YNB14F	M14 X 1.5	1	
YNB14EF	M14-1.25 1 1/16 AF	1	
YNB16C	M16 X 2 (24235)	1	
YNB16F	M16-1.50	1	
YNB18C	M18-2.5 1 7/16 AF	1	
YNB18F	M18-1.5 1 7/16 AF	1	
YNB18EF	M18-1.0 1 7/16 AF	1	
YNB20C	M20 X 2.5	1	
YNB22C	M22-1.5 1 5/8 AF	1	
YNB24C	M24 X 3	1	
YNB30C	M30-1.5 2 13/16 AF	1	

## HEXAGON CARBON STEEL RETHRADING DIE



Line: 1542-00

PART NUMBER	SIZE	QTY/BX	LIST PRICE
YEB02P	1/8-27 NPT	1	
YEB04U	1/4-20	1	
YEB04S	1/4-28	1	
YEB05U	5/16-18	1	
YEB05S	5/16-24	1	
YEB06U	3/8-16	1	
YEB06S	3/8-24	1	
YEB07U	7/16-14	1	
YEB07S	7/16-20	1	
YEB08U	1/2-13	1	
YEB08S	1/2-20	1	
YEB09U	9/16-12	1	
YEB09S	9/16-18	1	
YEB10U	5/8-11	1	
YEB10S	5/8-18	1	
YEB12U	3/4-10	1	
YEB12S	3/4-16	1	
YEB14U	7/8-9	1	
YEB14S	7/8-14	1	
YEB16U	1-8	1	
YEB16S	1-14	1	

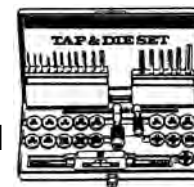

## TAP/DIE SETS HIGH SPEED OR CARBON

Line: 1542-11

PART NUMBER	SIZE	QTY/BX	LIST PRICE
BKZ37HISPD	38 PIECE #4/1/2 NC/NF	1	
BKZ37MET	37 PIECE M3-12 CARB MET	1	
BKZ64CARB	64 PIECE #4/ 1 NC/NF	1	
BKZ14NCCARB	14 PIECE USS & 1/8-27	1	
BKZ24HISPD	24 PIECE 1/4-1/2 C&F CARB	1	

## 328-329 T HANDLE

HAND TAP WRENCHES

Line: 1543-00

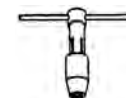

PART NUMBER	SIZE	QTY/BX	LIST PRICE
YFBJT20	0-1/4 STD SLIP HNDL	1	
YFBJT30	#12-5/16 STD SLIP	1	
YFBJT40	1/4-1/2 STD SLIP	1	
YFB0328R	1/16-1/4 RACHET GRNFLD	1	
YFB0332R	7/32-1/2 SLIP HNDL GRNFLD	1	
YFB0338H	1/16-1/4 RACHET/SLIP GNFLD	1	
YFB0339H	7/32-1/2RACHET/SLIP GRNFLD	1	

## HACK SAW BI-METAL

HIGH SPEED BLADES

Line: 1544-00



PART NUMBER	SIZE	QTY/BX	LIST PRICE
AAC100HSF	#100 HACK SAW FRAME	1	
AAC1018S	L10 X T18	10	
AAC1024S	L10 X T24	10	
AAC1032S	L10 X T32	10	
AAC1214X	L12 X T14	10	
AAC1218S	L12 X T18	10	
AAC1224S	L12 X T24	10	
AAC1232S	L12 X T32	10	
ACC101412VT	10/14 X 12 HVY DUTY	10	
ACC141812VT	14/18 X 12 HVY DUTY	10	
ACC182412VT	18/24 X 12 HVY DUTY	10	
ACC243212VT	24/32 X 12 HVY DUTY	10	

## HOLE SAWS BLUE-MOL BI-METAL

DEEP/REGULAR BLADES

Line: 1546-00



PART NUMBER	SIZE	QTY/BX	LIST PRICE
AEC09	9/16 STANDARD	1	
AEC409AGR	9/16 X DEEP HOLE	1	
AEC10	5/8 STANDARD	1	
AEC410AGR	5/8 DEEP HOLE	1	
AEC11	11/16 STANDARD	1	
AEC411AGR	11/16 DEEP HOLE	1	
AEC12	3/4 STANDARD	1	
AEC412AGR	3/4 DEEP HOLE	1	
AEC13	13/16 STANDARD	1	
AEC413AGR	13/16 DEEP HOLE	1	
AEC14	7/8 STANDARD	1	
AEC414AGR	7/8 DEEP HOLE	1	
AEC15	15/16 STANDARD	1	
AEC415AGR	15/16 DEEP HOLE	1	
AEC16	1 STANDARD	1	
AEC416AGR	1 DEEP HOLE	1	
AEC17	1 1/16 STANDARD	1	
AEC417AGR	1 1/16 DEEP HOLE	1	
AEC18	1 1/8 STANDARD	1	
AEC418AGR	1 1/8 DEEP HOLE	1	
AEC19	1 3/16 STANDARD	1	
AEC419AGR	1 3/16 DEEP HOLE	1	
AEC20	1 1/4 STANDARD	1	
AEC420AGR	1 1/4 DEEP HOLE	1	
AEC21	1 5/16 STANDARD	1	
AEC421AGR	1 5/16 DEEP HOLE	1	
AEC22	1 3/8 STANDARD	1	

(continued...)

## HOLE SAWS BLUE-MOL BI-METAL (cont.)

DEEP/REGULAR BLADES

Line: 1546-00



PART NUMBER	SIZE	QTY/BX	LIST PRICE
AEC422AGR	1 3/8 DEEP HOLE	1	
AEC23	1 7/16 STANDARD	1	
AEC423AGR	1 7/16 DEEP HOLE	1	
AEC24	1 1/2 STANDARD	1	
AEC424AGR	1 1/2 DEEP HOLE	1	
AEC25	1 9/16 STANDARD	1	
AEC425AGR	1 9/16 DEEP HOLE	1	
AEC26	1 5/8 STANDARD	1	
AEC426AGR	1 5/8 DEEP HOLE	1	
AEC27	1 11/16 STANDARD	1	
AEC427AGR	1 11/16 DEEP HOLE	1	
AEC28	1 3/4 STANDARD	1	
AEC428AGR	1 3/4 DEEP HOLE	1	
AEC29	1 13/16 STANDARD	1	
AEC429AGR	1 13/16 DEEP HOLE	1	
AEC30	1 7/8 STANDARD	1	
AEC430AGR	1 7/8 DEEP HOLE	1	
AEC32	2 STANDARD	1	
AEC432AGR	2 DEEP HOLE	1	
AEC33	2 1/16 STANDARD	1	
AEC433AGR	2 1/16 DEEP HOLE	1	
AEC34	2 1/8 STANDARD	1	
AEC434AGR	2 1/8 DEEP HOLE	1	
AEC36	2 1/4 STANDARD	1	
AEC436AGR	2 1/4 DEEP HOLE	1	
AEC37	2 5/16 STANDARD	1	
AEC437AGR	2 5/16 DEEP HOLE	1	
AEC38	2 3/8 STANDARD	1	
AEC438AGR	2 3/8 DEEP HOLE	1	
AEC40	2 1/2 STANDARD	1	
AEC440AGR	2 1/2 DEEP HOLE	1	
AEC41	2 9/16 STANDARD	1	
AEC441AGR	2 9/16 DEEP HOLE	1	
AEC42	2 5/8 STANDARD	1	
AEC442AGR	2 5/8 DEEP HOLE	1	
AEC44	2 3/4 STANDARD	1	
AEC444AGR	2 3/4 DEEP HOLE	1	
AEC46	2 7/8 STANDARD	1	
AEC446AGR	2 7/8 DEEP HOLE	1	
AEC48	3 STANDARD	1	
AEC448AGR	3 DEEP HOLE	1	
AEC50	3 1/8 STANDARD	1	
AEC450AGR	3 1/8 DEEP HOLE	1	
AEC52	3 1/4 STANDARD	1	

(continued...)

## HOLE SAWS BLUE-MOL BI-METAL (cont.)

DEEP/REGULAR BLADES

Line: 1546-00



PART NUMBER	SIZE	QTY/BX	LIST PRICE
AEC452AGR	3 1/4 DEEP HOLE	1	
AEC54	3 3/8 STANDARD	1	
AEC454AGR	3 3/8 DEEP HOLE	1	
AEC56	3 1/2 STANDARD	1	
AEC456AGR	3 1/2 DEEP HOLE	1	
AEC58	3 5/8 STANDARD	1	
AEC458AGR	3 5/8 DEEP HOLE	1	
AEC60	3 3/4 STANDARD	1	
AEC460AGR	3 3/4 DEEP HOLE	1	
AEC62	3 7/8 STANDARD	1	
AEC462AGR	3 7/8 DEEP HOLE	1	
AEC64	4 STANDARD	1	
AEC464AGR	4 DEEP HOLE	1	
AEC66	4 1/8 STANDARD	1	
AEC466AGR	4 1/8 DEEP HOLE	1	
AEC68	4 1/4 STANDARD	1	
AEC468AGR	4 1/4 DEEP HOLE	1	
AEC70	4 3/8 STANDARD	1	
AEC470AGR	4 3/8 DEEP HOLE	1	
AEC72	4 1/2 STANDARD	1	
AEC472AGR	4 1/2 DEEP HOLE	1	
AEC76	4 3/4 STANDARD	1	
AEC476AGR	4 3/4 DEEP HOLE	1	
AEC80	5 STANDARD	1	
AEC480AGR	5 DEEP HOLE	1	
AEC88	5 1/2 STANDARD	1	
AEC488AGR	5 1/2 DEEP HOLE	1	
AEC96	6 STANDARD	1	
AEC496AGR	6 DEEP HOLE	1	

## HOLE SAW KIT

Line: 1546-01



PART NUMBER	SIZE	QTY/BX	LIST PRICE
ABT9591LKSM	9 PC 7/8 - 2 1/8 LOCKSMITH	1	
ABT9592PLM	9 PC 3/4-2 1/4 PLUMBER	1	
ABT9593ELE	9 PC 7/8-2 1/8 ELECTRICAL	1	
ABT9691LKAGR	9 PC 7/8-2 1/8 LOCKSMITH DEEP HOLE	1	
ABT9599INDUS	20 PC 3/4-4 1/2 INDUSTRIAL	1	

## HOLE SAW ARBORS

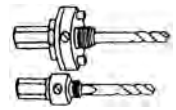

Line: 1547-00

PART NUMBER	SIZE	QTY/BX	LIST PRICE
AGC5506	DRIVE PLATE	1	
AGC5511	MANDREL ADAPTER	1	
AGCTC3	1/4 CARBIDE TIP BIT	1	
AGC-50	1/4 CHUCK (5514)	1	
AGC5515	1/4 UNIVERSAL 9/16-1 3/16	1	
AGC5516	1/4 UNIVERSAL 1 1/4-2	1	
AGC5519	3/8 HEX 9/16-1 13/16	1	
AGC5546	3/8 HEX CHUCK	1	
AGC5545	7/16 HEX 1 1/4-6	1	
AGC-S1	1/2 CHUCK (5518)	1	
AGC-S2	1/2 CHUCK (5520)	1	
AGCA5514	9/16-1 3/16 1/4 ROUND	1	
AGCA5515	9/16-1 3/16 1/4 UNIVERSAL	1	
AGCA5518	9/16-1 3/16 7/16 HEX	1	
AGCA5519	9/16-1 3/16 3/8 HEX	1	
AGCA5520	9/16-1 3/16 7/16 HEX	1	
AGC-S3	3/4 CHUCK (5573)	1	
AGCA5516	1 1/4-2 1/4 UNIVERSAL	1	
AGCA5545	1 1/4-1 1/2 7/16 HEX QUICK RELEASE	1	
AGCA5546	1 1/4-6 3/8 HEX QUICK RELEASE	1	
AGCA5573	1 1/4-6 5/8 HEX QUICK RELEASE	1	
AGC5500	12 EXTENSION	1	

## PILOT DRILL FOR HOLE SAW ARBOR

Line: 1548-00



PART NUMBER	SIZE	QTY/BX	LIST PRICE
AHC8534	1/4 X 3	1	
AHC16	1/4 X 4 1/4 (8535)	1	

## POWER BIT FINDER SLEEVE

COMP UNIT HARD

Line: 1549-01

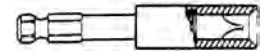

PART NUMBER	SIZE	QTY/BX	LIST PRICE
JHVR320	1/4 DRV 10F-12R SLOTTED	1	
JHVS320	1/4 DRV 12F-14R SLOTTED	1	
JHVT320	1/4 DRV 14F-16R SLOTTED	1	
JHVV321	7/16 DR 20F-22R SLOTTED	1	

## 1/4 HEX DRIVE PHILLIPS BIT

REDUCED POINT HARDENED

Line: 1549-02



PART NUMBER	SIZE	QTY/BX	LIST PRICE
AKC446-0	0 PT X 1 L	5	
AKC446-1	1 PT X 1 LEN	5	
AKC446-2	2 PT X 1 L	5	
AKC446-225	2 PT X 2 1/2	5	
AKC446-22	2 PT 1/4 HX X 2	5	
AKC446-215	2 PT 1/4 HX X 1 1/2	5	

## APEX HEX PHILLIPS BITS 1/4 DRIVE HARDENED

STANDARD HEX AND POWER BIT

Line: 1550-00

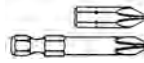

PART NUMBER	SIZE	QTY/BX	LIST PRICE
AKC01112	1 PT X 3 1/2 POWER BIT	5	
AKC01192	1 PT X 6 POWER BIT	5	
AKC440-1	1 PT - 1 L STANDARD HEX	5	
AKC440-215	2 PT - 1 1/2 L STANDARD HEX	5	
AKC02062	2 PT X 1 15/16 POWER BIT	5	
AKC440-2	2 PT - 1 L STANDARD HEX	5	
AKC440-22	2 PT - 2 L STANDARD HEX	5	
AKC440-225	2 PT - 2 1/2 L STANDARD HEX	5	
AKC02112	2 PT X 3 1/2 POWER BIT	5	
AKC02192	2 PT X 6 POWER BIT	5	
AKC440-3	3 PT - 1 L STANDARD HEX	5	
AKCSD-333	3PT X 1 1/4 #3125 HEAVY DUTY	5	
AKC03112	3 PT X 3 1/2 POWER BIT	5	
AKC03192	3 PT X 6 POWER BIT	5	
AKC440-4	4 PT - 1 1/4 L STANDARD HEX	5	

## 5/16 HEX DRIVE PHILLIPS BITS HARDENED

STANDARD HEX

Line: 1550-01

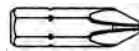

PART NUMBER	SIZE	QTY/BX	LIST PRICE
AKC480-1	1 PT X 1 1/4 L	5	
AKC480-2	2 PT X 1 1/4 LEN	5	
AKC480-3	3 PT X 1 1/4 LEN	5	
AKCSD795	4PT X 1 1/2 480-4BNX	5	
AKC480-4	4 PT X 1 1/4 LEN	5	

## 1/4 HEX DRIVE PHILLIPS BITS HARDENED

LONG SHANK

Line: 1550-02

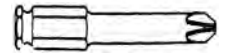

PART NUMBER	SIZE	QTY/BX	LIST PRICE
AKC4910	0 PT X 1 15/16 L	5	
AKC4910A	0 PT X 2 3/4 L	5	
AKC491	1 PT X 1 15/16 L	5	
AKC491A	1 PT X 2 3/4 L	5	
AKC491B	1 PT X 3 1/2 L	5	
AKC492	2 PT X 1 15/16 L	5	
AKC492A	2 PT X 2 3/4 L	5	
AKC492B	2 PT X 3 1/2 L	5	
AKC492CX	2 PT X 6 L	5	
AKC493	3 PT X 1 15/16 L	5	
AKC493A	3 PT X 2 3/4 L	5	
AKC493B	3 PT X 3 1/2 L	5	

## 5/16 HEX DRIVE PHILLIPS BITS HARDENED

LONG SHANK

Line: 1550-03



PART NUMBER	SIZE	QTY/BX	LIST PRICE
AKC632	2 PT X 2 1/2 480-225X	5	
AKC633	3 PT X 2 1/2 480-425X	5	

## 7/16 HEX DRIVE PHILLIPS BITS HARDENED

LONG SHANK

Line: 1550-04



PART NUMBER	SIZE	QTY/BX	LIST PRICE
AKC482	2 PT X 3 1/2 L	1	
AKC483	3 PT X 3 1/2 L	1	
AKC484	4 PT X 3 1/2 L	1	

## 5/16 SQUARE PHILLIPS BITS

Line: 1550-06



PART NUMBER	SIZE	QTY/BX	LIST PRICE
JVZ830-2	#2 X 1 1/8L APEX # 8	1	



CALL - 1 (800) 723-2826

## ACR PHILLIPS BITS HEX & POWER DRV STYLES

NON-SLIP PHILLIPS DRIVE

Line: 1550-07

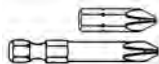

PART NUMBER	SIZE	QTY/BX	LIST PRICE
BLG1ACR	1/4 HX X 1 #1PT 440 STANDARD HEX	5	
BLG2ACR	1/4 HX X 1 #2PT 440 STANDARD HEX	5	
BLG3ACR	1/4 HX X 1 #3PT 440 STANDARD HEX	5	
BLG22ACR	1/4 HX X 2 #2PT 440 STANDARD HEX	5	
BLG1PACR	1/4X1-15/16 #1 POWER BIT	5	
BLG2PACR	1/4X1-15/16 #2 POWER BIT	5	
BLG3PACR	1/4X1.937 #3 POWER BIT	5	
BLG2275PACR	1/4X2.750 #2 POWER BIT	5	
BLG235PACR	1/4X3.500 #2PT POWER BIT	5	
BLG125ACR	5/16X1 1/4 #2PT 480 STANDARD HEX	5	
BLG3125ACR	5/16X1.250 #3PT 480 STANDARD HEX	5	
BLG4125ACR	5/16X1.250 #4PT 480 STANDARD HEX	5	

## APEX HEX SLOTTED DRIVING BITS HARDENED

Line: 1551-00



PART NUMBER	SIZE	QTY/BX	LIST PRICE
ALC445-1	4F-5R X 1L	5	
ALC445-1-15	4F-5R X 1 1/2 L	5	
ALC445-2	6F-8R X 1L	5	
ALC445-2-15	6F-8R X 1 1/2 L	5	
ALC445-3	8F-10R X 1L	5	
ALC445-3-15	8F-10R X 1 1/2 L	5	
ALC445-4	10F-12R X 1 L	5	
ALC445-4-15	10F-12R X 1 1/2 L	5	
ALC445-5	12F-14R X 1 1/2 L	5	
ALC445-6	14F-16R X 1 1/2 L	5	

## 1/4 HEX DRIVE SLOTTED BIT RED PT HARD

REDUCED POINT HARDENED

Line: 1551-01

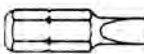

PART NUMBER	SIZE	QTY/BX	LIST PRICE
ALC445-00	2F-3R X 1 L	5	
ALC445-0	3F-R4 X 1 L	5	
ALC445-0-15	3F-4R X 1 1/2 L	5	
ALC445-10	4F-5R X 1 L	5	
ALC445-10-15	4F-5R X 1 1/2 L	5	
ALC445-20	5F-6R X 1 L	5	
ALC445-20-15	5F-6R X 1 1/2 L	5	
ALC445-30	6F-7R X 1 L	5	
ALC445-30-15	6F-7R X 1 1/2 L	5	

## 5/16 HEX DRIVE SLOTTED BIT RED PT HARD

REDUCED POINT HARDENED

Line: 1551-02



PART NUMBER	SIZE	QTY/BX	LIST PRICE
ALC485-1	4F-5R X 1 1/2 L	5	
ALC485-2	6F-8R X 1 1/2 L	5	
ALC485-3	8F-10R X 1 1/2 L	5	
ALC485-4	10F-12R X 1 1/2 L	5	
ALC485-5	12F-14R X 1 1/2 L	5	
ALC485-6	14F-16R X 1 1/2 L	5	
ALC485-7	16F-18R X 1 3/4 L	5	

## 1/4 HEX DRIVE SLOTTED BIT HARDENED

LONG SHANK POWER BIT

Line: 1551-03

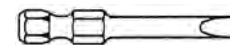

PART NUMBER	SIZE	QTY/BX	LIST PRICE
JGV320-1	4F-5R X 1 15/16 L	5	
JGV320-2	5F-6R X 1 15/16 L	5	
JGV320-3	6F-8R X 1 15/16 L	5	
JGV323-3	6F-8R X 3 L	5	
JGV326-3	6F-8R X 2 3/4 L	5	
JGV320-4	8F-10R X 1 15/16 L	5	
JGV323-4	8F-10R X 3 L	5	
JGV326-4	8F-10R X 2 3/4 L	5	
JGV320-5	10F-12R X 1 15/16	5	
JGV323-5	10F-12R X 3 L	5	
JGV326-5	10F-12R X 2 3/4 L 1	5	
JGV320-6	12F-14R X 1 15/16 L	5	
JGV323-6	12F-14R X 3 L	5	
JGV326-6	12F-14R X 2 3/4 L	5	

## 1/4 HEX DRIVE TORX BIT HARDENED

STANDARD HEX

Line: 1551-06

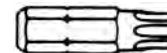

PART NUMBER	SIZE	QTY/BX	LIST PRICE
JJS440TX05	T5 .055	5	
JJS440TX07	T7 .077	5	
JJS440TX08	T8 .090	5	
JJS440TX09	T9 .097	5	
JJS440TX10	T10 .107	5	
JJS440TX15	T15 .128	5	
JJS440TX20	T20 .151	5	
JJS440TX25	T25 .173	5	
JJS440TX27	T27 .195	5	
JJS440TX30	T30 .216	5	
JJS440TX40	T40 .260	5	
JJS440TX45	T45 .306 X 1 1/4	5	

### 5/16 HEX DRIVE TORX BIT HARDENED

STANDARD HEX

Line: 1551-07



PART NUMBER	SIZE	QTY/BX	LIST PRICE
JJS480TX30	T30 .216	5	
JJS480TX40	T40 .260	5	
JJS480TX45	T45 .306	5	
JJS480TX50	T50 .346	5	
JJS480TX55	T55 .440	5	

### 1/4 HEX DRIVE TORX BIT HARDENED

LONG SHANK POWER BIT

Line: 1551-08

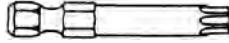

PART NUMBER	SIZE	QTY/BX	LIST PRICE
JJV49TX06	T6 X 1 15/16 LONG	5	
JJV49TX07	T7 X 1 15/16 LONG	5	
JJV49BTX07	T7 X 3 1/2 LONG	5	
JJV49TX08	T8 X 1 15/16 LONG	5	
JJV49BTX08	T8 X 3 1/2 LONG	5	
JJV49TX09	T9 X 1 15/16 LONG	5	
JJV49BTX09	T9 X 3 1/2 LONG	5	
JJV49TX10	T10 X 1 15/16 LONG	5	
JJV49BTX10	T10 X 3 1/2 LONG	5	
JJV49TX15	T15 X 1 15/16 LONG	5	
JJV49TX20	T20 X 1 15/16 LONG	5	
JJV49BTX20	T20 X 3 1/2 LONG	5	
JJV49TX25	T25 X 1 15/16 LONG	5	
JJV49ATX25	T25 X 2 3/4 LONG	5	
JJV49BTX25	T25 X 3 1/2 LONG	5	
JJV49TX27	T27 X 1 15/16 LONG	5	
JJV49ATX27	T27 X 2 3/4 LONG	5	
JJV49BTX27	T27 X 3 1/2 LONG	5	
JJV49TX30	T30 X 1 15/16 LONG	5	
JJV49ATX30	T30 X 2 3/4 LONG	5	
JJV49BTX30	T30 X 3 1/2 LONG	5	
JJV49ATX40	T40 X 2 3/4 LONG	5	
JJV49TX40	T40 X 3 1/2 LONG	5	
JJV49BTX40	T40 X 3 1/2 LONG	5	

### 1/4 HEX DRIVE POSIDRIVE BIT HARDENED

STANDARD HEX

Line: 1551-09



PART NUMBER	SIZE	QTY/BX	LIST PRICE
JKV4401P2D	#1 X 1 L	5	
JKV4461P2D	#1 X 1 L RP	5	
JKV4402P2D	#2 X 1 L	5	
JKV4462P2D	#2 X 1 L RP	5	
JKV4403P2D	#3 X 1 L	5	

### 5/16 HEX DRIVE POSIDRIVE BIT HARDENED

STANDARD HEX

Line: 1551-10



PART NUMBER	SIZE	QTY/BX	LIST PRICE
JKV4802P2D	#2 X 1 1/4 L	5	
JKV4803P2D	#3 X 1 1/4 L	5	
JKV4804P2D	#4 X 1 1/4 L	5	

### TORX TAMPER PROOF DRIVE BITS

1/4 H X 1 LONG STANDARD HEX

Line: 1551-11



PART NUMBER	SIZE	QTY/BX	LIST PRICE
BPG7TTP	#7 TORX (440-TX-07-H)	2	
BPG8TTP	#8 TORX (440-TX-08-H)	2	
BPG10TTP	#10 TORX (440-TX-10-H)	2	
BPG15TTP	#15 TORX (440-TX-15-H)	2	
BPG20TTP	#20 TORX (440-TX-20-H)	2	
BPG25TTP	#25 TORX (440-TX-25-H)	2	
BPG27TTP	#27 TORX (440-TX-27-H)	2	
BPG30TTP	#30 TORX (440-TX-30-H)	2	
BPG40TTP	#40 TORX (440-TX-40-H)	2	

### PHILLIPS / SQUARE QUADREX HEX DRIVE

ACR BITS POWER BITS

Line: 1551-15



PART NUMBER	SIZE	QTY/BX	LIST PRICE
CEVX2ACR	1/4 HEX X 1LG INSERT	5	
CEVX22ACR	1/4 X 1-15/16 POWER	5	

### APEX SQUARE BIT HEXAGON

1/4 DRIVE STANDARD HEX AND POWER BIT

Line: 1551-20

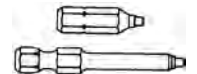

PART NUMBER	SIZE	QTY/BX	LIST PRICE
AUS950X2	REG/INSERT #8/9/10 STANDARD HEX	5	
AUS9541X	#1 X 1 15/16 5-6-7 STANDARD HEX	5	
AUS954A1X	#1 X 2 3/4 5-6-7 SC STANDARD HEX	5	
AUS954-C-1	#1 X 6 STANDARD HEX	5	
AUS9542X	#2 X 1 15/16 8-9-10 STANDARD HEX	5	
AUS954A2X	#2 X 2 3/4 8-9-10 STANDARD HEX	5	
AUS954-C-2	#2 X 6 STANDARD HEX	5	
AUS02096	#2 SQ DRV X 3 POWER BIT	5	
AUS02128	#2 SQ DRV X 4 POWER BIT	5	
AUS02192	#2 SQ DRV X 6 POWER BIT	5	
AUS9543X	#3 X 1 15/16 12-14 STANDARD HEX	5	
AUS954A3X	#3 X 2 3/4 12-14 STANDARD HEX	5	
AUS03096	#3 SQ DRV X 3 POWER BIT	5	
AUS03192	#3 SQ DRV X 6 POWER BIT	5	

## SPANNER HEX DRIVE BITS

SNAKE EYES STANDARD HEX

Line: 1551-21



PART NUMBER	SIZE	QTY/BX	LIST PRICE
BLH4SP	#4 SCREW	5	
BLH6SP	#6 SCREW 1/4 X 1	5	
BLH8SP	#8 SCREW 1/4 X 1	5	
BLH10SP	#10 SCREW 1/4 X 1	5	
BLH1204SP	#12 SCREW 1/4 X 1	5	
BLH12SP	#12 SCREW 5/16 HEX	5	
BLH1404SP	#14 SCREW 1/4 X 1	5	
BLH14SP	#14 SCREW 5/16 HEX	5	

## APEX 5/16 HEX MAGNETIC BIT HOLDER

Line: 1552-00



PART NUMBER	SIZE	QTY/BX	LIST PRICE
AMCM630	1/4 BIT X 3 LONG	1	
AMCM638	5/16 BIT X 3 3/32 LONG	1	

## 5/16 HEX DRIVE BIT HOLDER

Line: 1552-01



PART NUMBER	SIZE	QTY/BX	LIST PRICE
AMC630	1/4 BIT X 1 13/16 LONG	1	
AMC638	5/16 BIT X 2 1/2 LONG	1	

## APEX 1/4 HEX MAGNETIC BIT HOLDER

Line: 1553-00

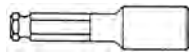

PART NUMBER	SIZE	QTY/BX	LIST PRICE
AMCM490-2	1/4 BIT X 2 LONG	1	
AMCM490	1/4 BIT X 3 LONG	1	
AMCM490-4	1/4 BIT X 4 LONG	1	
AMCM490-6	1/4 BIT X 6 LONG	1	
AMCM490-8	1/4 BIT X 8 LONG	1	
AMCM490-10	1/4 BIT X 10 LONG	1	
AMCM498	5/16 BIT X 3 1/16 LONG	1	
AMCM499E	5/16 BIT X 3 1/2 LONG	1	

## 1/4 HEX BIT HOLDER

Line: 1553-01

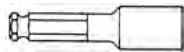

PART NUMBER	SIZE	QTY/BX	LIST PRICE
AMC490	1/4 BIT X 2 1/8 LONG	1	
AMC490-4	1/4 BIT X 4 LONG	1	
AMC490-6	1/4 BIT X 6 LONG	1	
AMC490-8	1/4 BIT X 8 LONG	1	
AMC490-10	1/4 BIT X 10 LONG	1	
AMCM490-12	1/4 BIT X 12 MAGNET LONG	1	

## 7/16 HEX DRIVE MAGNETIC BIT HOLDER

Line: 1553-02

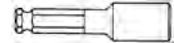

PART NUMBER	SIZE	QTY/BX	LIST PRICE
AMCM480	5/16 BIT X 3 5/16 LONG	1	

## 7/16 HEX DRIVE BIT HOLDER

Line: 1553-03

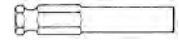

PART NUMBER	SIZE	QTY/BX	LIST PRICE
AMC488	1/4 BIT X 2 3/4 LONG	1	
AMC480	5/16 BIT X 2 3/4 LONG	1	

## SQUARE DRIVE BIT HOLDER

Line: 1553-05

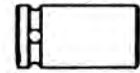

PART NUMBER	SIZE	QTY/BX	LIST PRICE
JMV825	1/4 BIT X 1/4 DRV	1	
JMV838	1/4 BIT X 3/8 DRV	1	
JMV858	1/4 BIT X 1/2 DRV	1	
JMV835	5/16 BIT X 3/8 DRV	1	
JMV855	5/16 BIT X 1/2 DRV	1	

## SQUARE DRIVE MAGNETIC BIT HOLDER

Line: 1553-06

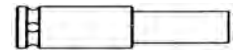

PART NUMBER	SIZE	QTY/BX	LIST PRICE
JMVM825	1/4 BIT X 1/4 DRV	1	
JMVM838	1/4 BIT X 3/8 DRV	1	
JMVM858	1/4 BIT X 1/2 DRV	1	
JMVM835	5/16 BIT X 3/8 DRV	1	

## HEX TO SQUARE DRIVE ADAPTERS

Line: 1553-07

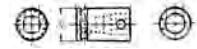

PART NUMBER	SIZE	QTY/BX	LIST PRICE
JNVSC308	1/4 HEX X 3/8 SQ	1	
JNVSC314	7/16 HEX X 3/8 SQ	1	
JNVSC514	7/16 HEX X 1/2 SQ	1	



**CALL - 1 (800) 723-2826**

**CALL: (800) 723-2826**



## 1/4 PREMIUM HEX DRIVE MAGNETIC NUT DRIVER

Line: 1553-08



PART NUMBER	SIZE	QTY/BX	LIST PRICE
JPVMHM2508	1/4 HEX X 1 1/8 LONG	1	
JPVMDA08	1/4 HEX X 1 5/8 LONG	1	
JPVMDB08	1/4 HEX X 2 9/16 LONG	1	
JPVMDA10	5/16 HEX X 1 5/8 LONG	1	
JPVMDB10	5/16 HEX X 2 9/16 LONG	1	
JPVMDA12	3/8 HEX X 1 3/4 LONG	1	
JPVMDB12	3/8 HEX X 2 9/16 LONG	1	

## APEX 1/4 HEX SQUARE MAGNETIC SOCKET

Line: 1554-00



PART NUMBER	SIZE	QTY/BX	LIST PRICE
ANCMIP06	3/16 HEX	1	
ANCMIP07	7/32 HEX	1	
ANCMX1108	1/4 HEX	5	
ANCMX1109	9/32 HEX	1	
ANCMIP10	5/16 HEX	1	
ANCMIP11	11/32 HEX	1	
ANCMIP12	3/8 HEX	1	
ANCMIP14	7/16 HEX	5	
ANCMIP16	1/2 HEX	1	

## 3/8 SQUARE DRIVE SOCKET

FOR SMS MAGNETIC

Line: 1554-01



PART NUMBER	SIZE	QTY/BX	LIST PRICE
ANCM3P06	3/16 HEX	1	
ANCM3P08	1/4 HEX	1	
ANCM3P09	9/32 HEX	1	
ANCM3P10	5/16 HEX	1	
ANCM3P12	3/8 HEX	1	
ANCM3P14	7/16 HEX	1	
ANCM3P16	1/2 HEX	1	
ANCM3P18	9/16 HEX	1	

## SOCKET HEAD BITS

STANDARD AND TAMPER PROOF

Line: 1554-02



PART NUMBER	SIZE	QTY/BX	LIST PRICE
KAA185-0	1/4 HEX DRV X 5/64 HX STANDARD	5	
KAA185-00	1/4 HEX DRV X 1/16 HX STANDARD	5	
KAA185-000	1/4 HEX DRV X .050 HX STANDARD	5	
KAA185-1	1/4 HEX DRV X 3/32 HX STANDARD	5	
KAA185-10	1/4 HEX DRV X 9/64 HX STANDARD	5	
KAA185-2	1/4 HEX DRV X 1/8 HX STANDARD	5	
KAA185-3	1/4 HEX DRV X 5/32 HX STANDARD	5	
KAA185-3MM	1/4 HEX DRV X M3 HEX STANDARD	5	
KAA185-4	1/4 HEX DRV X 3/16 HX STANDARD	5	
KAA185-5	1/4 HEX DRV X 7/32 HX STANDARD	5	
KAA185-6	1/4 HEX DRV X 1/4 HX STANDARD	5	
KAA185-9	1/4 HEX DRV X 7/64 HX STANDARD	5	
KAA315-3	5/16HX STANDARD DRV X 5/32HX STD	1	
KAA315-4	5/16HX STANDARD DRV X 3/16HX STD	1	
KAA315-5	5/16 HX DRV X 7/32 STANDARD	5	
KAA315-6	5/16 HX DRV X 1/4 HX STANDARD	5	
KAA315-7	5/16 HX DRV X 5/16 STANDARD	5	
KAA315-8	5/16 HX DRV X 3/8 HX STANDARD	5	
KAA185-10HTP	9/64 TAMPER PROOF 1/4 X 1	5	
KAA185-3HTP	5/32 TAMPER PROOF 1/4 X 1	5	
KAA185-4HTP	3/16HX TAMPER PROOF 1/4 X 1	5	
KAA185-5HTP	7/32 TAMPER PROOF 1/4 X 1	5	
KAA185-6HTP	1/4 TAMPER PROOF 1/4 X 1	5	

## APEX 1/4 SQUARE MALE EXTENSION

PIN AND BALL

Line: 1555-00

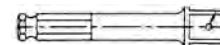

PART NUMBER	SIZE	QTY/BX	LIST PRICE
APCEX250	1/4 M HX 1 3/8 PIN	1	
APCEX250B	1/4M HX X 1 3/8 BALL	1	
APCEX250-2	1/4M HX X 2 PIN	1	
APCEX250B-2	1/4M HX X 2 BALL	1	
APC250B-3	1/4M HX X 3 BALL 25	1	
APCEX250-8	1/4M HX X 8 PIN	1	
APCEX250-12	1/4M HX X 12 PIN	1	
APCEX262B	5/16 MHX 1 1/2 BALL	1	

## 3/8 MALE SQUARE EXTENSION

PIN AND BALL

Line: 1555-01

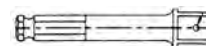

PART NUMBER	SIZE	QTY/BX	LIST PRICE
APCEX500-2	1/4 HX X 1/2 SQ W/PIN	1	
APCEX380	5/16 MHX 1 1/2 PIN	1	
APCEX380B	5/16 MHX 1 1/2 BALL	1	
APCEX371-3	7/16 MHX X 3 PIN	1	
APCEX371B-3	7/16 MHX X 3 BALL	1	

## REVERSIBLE MAGNETIC SOCKET

FOR SMS HDS

Line: 1555-02

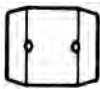

PART NUMBER	SIZE	QTY/BX	LIST PRICE
JRVMRST04	1/4 HX DBL/TPR SOC CD	5	
JRVMSW350	1/4 HEX	1	
JRVMSW90B	1/4 HX TAPER END	1	
JRVMSW984B	5/16 HX TAPER END	1	
JRVMSH400	3/8 HEX	1	
JRVMSH401	7/16 HEX	1	

## HEX DRIVE SHANKS FOR MAGNETIC SOCKET

Line: 1555-03

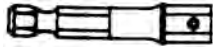

PART NUMBER	SIZE	QTY/BX	LIST PRICE
JSVSH629	1/4 HEX DRV	1	
JSVSH59	5/16 HEX DRV	1	
JSVSH412	3/8 HEX DRV	1	
JSVSH413	7/16 HEX DRV	1	
JSVSH414	1/2 HEX DRV	1	

## APEX UNIVERSAL JOINT SOCKET EXTENSION

Line: 1555-05

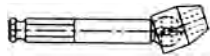

PART NUMBER	SIZE	QTY/BX	LIST PRICE
AUMKC253	1/4 HEX W/3 EXTENSION	1	
AUMKC256	1/4 HEX W/6 EXTENSION	1	
AUMKC259	1/4 HEX W/9 EXTENSION	1	
AUMKC266	5/16 HEX X 6 EXTENSION	1	
AUMKC276	11/32 HEX X 6 EXTENSION	1	
AUMKC286	3/8 HEX X 6 EXTENSION	1	
AUMKC296	7/16 HEX X 6 EXTENSION	1	
AUMKC306	1/2 HEX X 6 EXTENSION	1	

## APEX BIT/DRIVER/CHUCK TRAY

ASSORTMENT

Line: 1555-09



PART NUMBER	SIZE	QTY/BX	LIST PRICE
BBZ28	28PC PH/SLT/TRX/BITS	1	

## MISCELLANEOUS TOOLS AND PARTS

Line: 1555-10

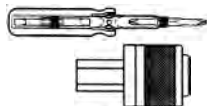

PART NUMBER	SIZE	QTY/BX	LIST PRICE
JRZ1001	POWER BIT ADPT QUICK RELEASE	1	
JRZ417866	MAGNA DRIVE BIT KIT	1	
JRZMS4IN1	4 IN 1 SCREWDRIVER W/BITS	1	

## BI-METAL SABRE JIG SAW BLADE

1/2 SHANK

Line: 1555-11



PART NUMBER	SIZE	QTY/BX	LIST PRICE
AFZRB1218HDM	METAL CUT 18/.035 X 12	5	
AFZULB114	METAL SCRL/14X2.5AG114	5	
AFZULB118	METAL/SCRL/18X2.5 AG118	5	
AFZULB1203	WOOD 2/3TPIX12AG1210B	5	
AFZULB1208	WOOD 6TPI/12AG1208	5	
AFZULB210	METAL 10 X 4AG210	5	
AFZULB405	PLSTR CUT 6X6AG405	5	
AFZULB410	COMBO 10/14X8AG410	5	
AFZULB608	WOOD 6TPI X 6AG608	5	
AFZULB608S	WOOD 6TPI X 6AG608	5	
AFZULB610	WOOD 10TPI X 6AG610	5	
AFZULB906S	WOOD 6TPI X 9AG906	5	
AFZ70620	METAL 14 X 4 AG214	5	
AFZ70630	METAL 18 X 4 AG218	10	
AFZ70640	METAL 10 X 6 AG310	5	
AFZ70650	METAL 14 X 6 AG314	10	
AFZ70660	METAL 18 X 6 AG318	10	
AFZ70670	METAL 24 X 6 AG324	5	
AFZ77170	METAL 24 X 4 AG224	5	

## SABRE JIG SAW BLADES

1/4 SHANK

Line: 1555-12



PART NUMBER	SIZE	QTY/BX	LIST PRICE
AFZJ12	COMBO YEL 14 X 3 (J8)	5	
AFZJ14	COMBO YEL 18 X 3 (J9)	5	
AFZJ3	WOOD CUT BLK 6 X 4	5	
AFZJ4	WOOD SCRL 10 X 3 1/2	2	
AFZJ9	METAL RED 18 X 3 (J9)	5	
AFZ80010	METAL 14 X 3 (J8)	5	
AFZ80020	METAL 24 X 3 (J10)	5	
AFZ80030	METAL 32 X 3 (J11)	5	
AFZJ15	18 X 3 9J9)	5	

## CARBON RECIPROCATING JIG SAW BLADES

RED

Line: 1555-13



PART NUMBER	SIZE	QTY/BX	LIST PRICE
ASSHDMC214	METAL SCRL 14 X 3 5/8	5	
ASSHDM210	METAL 10 X 4	5	
ASSHDM310	METAL 10 X 6	5	
ASSHDM410	METAL 10 X 8	2	
ASSHDM114	METAL 14 X 2 1/2	5	
ASSHDM214	METAL 14 X 4	5	

(continued...)

CALL: (800) 723-2826

## CARBON RECIPROCATING JIG SAW BLADES (cont.)

RED

Line: 1555-13



PART NUMBER	SIZE	QTY/BX	LIST PRICE
ASSHDM314	METAL 14 X 6	5	
ASSHDM118	METAL 18 X 2 1/2	5	
ASSHDM218	METAL 18 X 4	5	
ASSHDM318	METAL 18 X 6	5	
ASSHDM224	METAL 24 X 4	5	
ASSHDM324	METAL 24 X 6	5	
ASSHDM232	METAL 32 X 4	5	
ASSWCD606	WOOD SCRL 6 X 6	2	
ASSWC608	WOOD TAPER 6 X 6	5	
ASSW210	WOOD CUT 10 X 3 1/2	5	
ASSW410	WOOD CUT 10 X 6	2	
ASSW406	WOOD CUT 6 X 6	2	

## BAYONET JIG SAW BLADES

BI-METAL

Line: 1555-14



PART NUMBER	SIZE	QTY/BX	LIST PRICE
ASPR55	MET-BIMETAL 10 X 3	5	
ASPR57	MET SCR BIMET 14 X 2	5	
ASPR56	MET-BIMETAL 14 X 3	5	
ASPR60	MET SCR BIMET 24 X 2	5	
ASPR58	MET-BIMETAL 24 X 3	5	

## BOSCH MACHINE MODEL JIG SAW BLADES

Line: 1555-15



PART NUMBER	SIZE	QTY/BX	LIST PRICE
ASRRB10	WOOD CUT 6 X 4	5	
ASRRB20	WOOD CUT 10 X 4	5	
ASRRB30	WOOD SCRL 10 X 4	5	
ASRRB40	METAL HS 10 X 3 3/4	5	
ASRRB50	METAL HS 14 X 3	5	
ASRRB60	METAL HS 18 X 3	5	
ASRRB70	METAL HS 24 X 3	5	
ASRRB80	METAL HS 32 X 3	5	

## GRIT EDGE RECPT & JIG SAW BLADES

Line: 1555-16



PART NUMBER	SIZE	QTY/BX	LIST PRICE
BLFCRS	JIG 2 3/4 COURSE (GJ6)	1	
BLFFINE	JIG 2 3/4 FINE (GJ2)	1	
BLFMED	JIG 2 3/4 MEDIUM (GJ4)	1	
BLF4	4 1/2 SHKREC (GR20)	1	
BLF6	6 1/2 SHNK REC (GR24)	1	
BLF8	8 1/2 SHNK REC (GR26)	1	

## 1/4 MAGNETIC HEX DRIVE

SCREW/NUT SETTER

Line: 1555-25

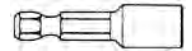

PART NUMBER	SIZE	QTY/BX	LIST PRICE
ANVELSH04080	ACOUSTICAL LAG DRVR1	1	
ANV04ECON	1/4 HEX X 1 3/4 LONG	5	
ANV05ECON	5/16 HEX X 1 3/4 LONG	5	
ANV06ECON	3/8 HEX X 1 3/4 LONG	5	
ANV07ECON	7/16 HEX X 1 3/4 LONG	5	
ANV08ECON	1/2 HEX X 1 3/4 LONG	2	

## CUTTING RECOMMENDATIONS

	Blade Type	TPI	Best Used for Cutting:
	Bi-Metal and High Speed Steel Metal Cutting Blades.	10	Heavy gauge metal, fiber and rubber 1/4" and thicker.
		14	Heavy gauge metal, bar stock, angles, fiber and rubber 1/8" to 1/4" thick.
		18	Pipe, conduit, tubing and channel 18 gauge to 1/8" thick.
		24	Galvanized pipe and metal 18 gauge and under.
		32	Sheet Metal, trim, and other very thin metals.
	Carbon Wood Cutting	6	Fast cutting nail-free wood and fiberboard.
		10	Smooth cutting nail embedded wood and fiberboard.
	Bi-Metal and Carbon Wood Cutting	10	General rough-in including nail embedded wood.
		6	General rough-in including nail-embedded wood.
		2/3	Fastest cutting for rough-in including nail-embedded wood.
	Bi-Metal and High Speed Steel Metal Scroll Blades	10	Irregular shapes and contours in metals 1/4" thick (HSS Only)
		14	Irregular shapes and contours in metals 1/8" to 1/4" thick.
		18	Irregular shapes and contours in metals 18 Gauge to 1/8" thick.
		24	Irregular shapes and contours in metals 18 Gauge and under.
	Wood Scroll Blades	6	Irregular shapes and contours in all wood.
		10	Irregular shapes and contours in all wood.
		6	Hollow ground fast scroll cuts in wood and plastic.
	Bi-Metal and Carbon Plaster Cutting	6	Plaster and plaster board "V" style tooth cuts on both forward and back strokes.
		10	Combination wood and plaster.

# SECTION 17 PRODUCT INDEX



Line Description	Alpha	Line#	Page#
HOSE CLAMPS STAIN BAND/STEEL SCREW	PLB	1556-00	17-3
HOSE CLAMPS ALL STAINLESS PARTS	PMB	1557-00	17-3
HOSE CLAMPS 1-EAR CRIMP TYPE - ZINC	BGC	1557-01	17-4
HOSE CLAMPS 2-EAR CRIMP TYPE - ZINC	BHC	1557-02	17-4
BATTERY BOLTS - ZINC PLATED	PNB	1559-00	17-5
HI-COLLAR BATTERY BOLTS NUTS - ZINC	PPB	1560-00	17-5
BATTERY HOLD DOWN BOLTS - ZINC PLATED	PRB	1564-00	17-5
ROUND J HOOK BATTERY HOLD DOWN BOLTS W/W-W	PRB	1564-05	17-5
FLAT J HOOK BATTERY HOLD DOWN BOLTS W/W-W	PRB	1564-06	17-5
3M ELECTRICAL SELF-SEAL INSULATING MASTIC	ADE	1567-10	17-5
ELECTRICAL TAPES	PTB	1568-00	17-5
EMERY CLOTH ROLLS 50FT UNITS	JJP	1568-01	17-6
INDUSTRIAL TAPES	PTB	1568-02	17-6
TEFLON TAPE ROLLS QUALITY GRADE	PUB	1570-00	17-6
TEFLON TAPE ROLLS ECONOMY	HVD	1571-00	17-6
SAF-T-LOK LOCKING SEALANTS	PVB	1572-00	17-6
SAF-T-LOK INSTANT BONDER	AMM	1572-01	17-7
SAF-T-LOK ANTI-SEEZ CHEMICAL PRODUCTS	PWB	1572-10	17-7
SILICONE RUBBER SEALANT (TUBES)	PWB	1572-11	17-7
CRC CHEMICAL PRODUCTS	PWB	1572-12	17-7
HB1 SPRAY OR SPOUT TAP CUTTING FLUID	JXN	1572-13	17-9
PB BLASTER PENETRATING CATALYST	PWB	1572-14	17-9
SEYMOUR AEROSOL PAINT PRODUCTS	SEY	1572-15	17-9
COIL INSERT THREAD REPAIR KITS INCH	WKB	1574-00	17-10
COIL INSERT THREAD REPAIR KITS METRIC	ACP	1574-01	17-10
COIL INSERT MASTER THREAD REPAIR KITS	ACT	1574-02	17-11
COIL THREAD REPAIR INSERTS NC/NF SHORT-MED-LG	WNB	1575-00	17-11
COIL THREAD REPAIR INSERTS METRIC SHORT-MED-LG	AAN	1575-01	17-13
COIL INSERT SPARK PLUG KITS	ACR	1575-02	17-14
COIL INSERT PIPE THREAD COILS & KITS	ACS	1575-03	17-14
PREMIUM NYLON CABLE TIES TYTON BRAND	ZFB	1587-00	17-15
CABLE TIE ACCESSORIES	ACC	1587-01	17-15
4-WAY CABLE TIE MOUNTING BASE	ADD	1587-02	17-15
STANDARD GRADE NYLON CABLE TIES	CDN	1587-04	17-16
CABLE TUBING CLAMP LITE DUTY VINYL COATED	ZGB	1588-00	17-16
CABLE TUBING CLAMP HEAVY DUTY VINYL COATED	ZHB	1589-00	17-16
NYLON HEAVY DUTY TUBING CLAMPS	ZTB	1590-00	17-16
NYLON REGULAR DUTY TUBING CLAMPS	ZJB	1591-00	17-16
ALUMINUM TUBING CLAMP - EPDM COVER	ZKB	1592-00	17-16
JIFFY TYPE TUBING CLAMP	ZKB	1593-00	17-16

(CONTINUED...)

# SECTION 17 PRODUCT INDEX



Line Description	Alpha	Line#	Page#
SHRINK TUBING DOUBLE WALL	JED	1594-00	17-17
RUBBER O-RINGS BUNA-N MATERIAL	ZPB	1598-00	17-17
RUBBER O-RINGS VITON MATERIAL	JVF	1598-01	17-20
RUBBER O-RINGS METRIC BUNA-N	ZPB	1598-02	17-22
JACK NUT THREADED STEEL INSERT - ZINC	BLW	1612-10	17-23
WELL NUT NEOPRENE W/BRASS INSERT	BLX	1612-11	17-23
COLORED SCREW COVERS & BASES	AYE	1616-01	17-24
SNAP STUD-CAP-SOCKET-TURN FASTENERS	CCL	1616-16	17-24
MUFFLER CLAMPS - REGULAR & HEAVY DUTY	FHD	1618-00	17-24
EZ LOCK THREADED INSERTS - STEEL	BJC	1621-00	17-24
EZ LOCK METRIC THREADED INSERTS - STEEL	BKC	1622-00	17-25
EZ LOCK WOOD/PLASTIC INSERTS - BRASS	BJK	1622-01	17-25
KNIFE THREAD WOOD INSERTS - STEEL	BJK	1622-02	17-25
AUTOMOTIVE WHEEL BALANCE WEIGHTS	CFB	1622-95	17-26
SELECT TRUCK WHEEL STUDS	DMC	1622-99	17-27
RUBBER TARP STRAPS W/STEEL HOOKS	DMC	1623-01	17-27



**CALL - 1 (800) 723-2826**

## HOSE CLAMP - DOMESTIC

STAINLESS BAND W/ STEEL SCREW

Line: 1556-00



PART NUMBER	SIZE	QTY/BX	LIST PRICE
PLB004P	7/32-5/8 MINI 4P	10	
PLB006P	5/16-7/8 MINI 6P	10	
PLB006H	3/8-7/8 6H	10	
PLB008P	7/16-1 MINI 8P	10	
PLB008H	7/16-1 8H	10	
PLB010P	1/2-1 1/16 MINI 10P	10	
PLB010H	1/2-1 1/16 10H	10	
PLB012P	9/16-1 1/4 MINI 12P	10	
PLB012H	9/16-1 1/4 12H	10	
PLB016P	11/16-1 1/2 MINI 16P	10	
PLB016H	11/16-1 1/2 16H	10	
PLB020P	7/8-1 3/4 MINI 20P	10	
PLB020H	3/4-1 3/4 20H	10	
PLB024H	1 1/16-2 24H	10	
PLB028H	1 5/16-2 1/4 28H	10	
PLB032H	1 9/16-2 1/2 32H	10	
PLB036H	1 13/16-2 3/4 36H	10	
PLB040H	2 1/16-3 40H	10	
PLB044H	2 5/16-3 1/4 44H	10	
PLB048H	2 9/16-3 1/2 48H	10	
PLB052H	2 13/16-3 3/4 52H	10	
PLB056H	3 1/16-4 56H	10	
PLB060H	3 5/16-4 1/4 60H	10	
PLB064H	3 9/16-4 1/2 64H	10	
PLB072H	4 1/16-5 72H	10	
PLB080H	4 5/8-5 1/2 80H	10	
PLB088H	4 3/32-6 88H	10	
PLB096H	4 1/2-6 1/2 96H	10	
PLB104H	5-7 104H	10	
PLB116H	5 3/4-7 3/4 116H	10	
PLB41100	CREATE A CLAMP BANDING	50	
PLB415KIT	CREATE A CLAMP KIT	1	
PLB41610	CREATE A CLAMP SPLICES	10	
PLB41620	CREATE A CLAMP FASTENERS	20	

## HOSE CLAMP - DOMESTIC

ALL STAINLESS

Line: 1557-00



PART NUMBER	SIZE	QTY/BX	LIST PRICE
PMB004S	7/32-5/8 MINI 4S	10	
PMB006S	5/16-7/8 MINI 6S	10	
PMB006HS	3/8-7/8 (6HS)	10	
PMB008S	7/16-1 MINI (8S)	10	
PMB008HS	7/16-1 (8HS)	10	
PMB010S	1/2-1 1/16 MINI (10S)	10	
PMB010HS	9/16-1 1/16 (10HS)	10	
PMB012S	9/16-1 1/4 MINI (12S)	10	
PMB012HS	9/16-1 1/4 (12HS)	10	
PMB016S	11/16-1 1/2 MINI (16S)	10	
PMB016HS	11/16-1 1/2 (16HS)	10	
PMB020S	7/8-1 3/4 MINI (20S)	10	
PMB020HS	3/4-1 3/4 (20HS)	10	
PMB024HS	1 1/16-2 (24HS)	10	
PMB028HS	1 5/16-2 1/4 (28HS)	10	
PMB032HS	1 9/16-2 1/2 (32HS)	10	
PMB036HS	1 13/16-2 3/4 (36HS)	10	
PMB040HS	2 1/16-3 (40HS)	10	
PMB044HS	2 5/16-3 1/4 (44HS)	10	
PMB048HS	2 9/16-3 1/2 (48HS)	10	
PMB052HS	2 13/16-3 3/4 (52HS)	10	
PMB056HS	3 1/16-4 (56HS)	10	
PMB060HS	3 5/16-4 1/4 (60HS)	10	
PMB064HS	3 9/16-4 1/2 (64HS)	10	
PMB072HS	4 1/16-5 (72HS)	10	
PMB080HS	4 5/8-5 1/2 (80HS)	10	
PMB088HS	4 3/32-6 (88HS)	10	
PMB096HS	4 1/2-6 1/2 (96HS)	10	
PMB104HS	5-7 (104HS)	10	
PMB116HS	5 3/4-7 3/4 (116HS)	10	
PMB128HSP	5 1/2-8 7/16 (128HSP)	10	
PMB188QRHS	#188 QUICK RELEASE	10	
PMB312QRHS	#312 QUICK RELEASE	10	

**HOSE CLAMP - 1 EAR CRIMP TYPE**



Line: 1557-01

PART NUMBER	SIZE	QTY/BX	LIST PRICE
BGC07	7/16	25	
BGC075	15/32	25	
BGC08	1/2	25	
BGC09	9/16	25	
BGC095	19/32	25	
BGC10	5/8	25	
BGC11	11/16	25	
BGC12	3/4	25	
BGC13	13/16	25	
BGC14	7/8	25	
BGC15	15/16	25	
BGC16	1	25	
BGC18	1 1/8	25	
BGC19	1 3/16	25	
BGC20	1 1/4	25	
BGC21	1 5/16	25	
BGC22	1 3/8	25	
BGC23	1 7/16	25	
BGC24	1 1/2	25	
BGC26	1 5/8	25	
BGC28	1 3/4	25	
BGC30	1 7/8	25	
BGC32	2	25	

**HOSE CLAMP - 2 EAR CRIMP TYPE**



Line: 1557-02

PART NUMBER	SIZE	QTY/BX	LIST PRICE
BHC1098	1098 CRIMP PLIERS	1	
BHC03	3/16	25	
BHC04	1/4	25	
BHC05	5/16	25	
BHC06	3/8	25	
BHC07	7/16	25	
BHC08	1/2	25	
BHC09	9/16	25	
BHC095	19/32	25	
BHC10	5/8	25	
BHC12	3/4	25	
BHC13	13/16	25	
BHC14	7/8	25	
BHC15	15/16	25	
BHC16	1	25	
BHC17	1 1/16	25	
BHC18	1 1/8	25	
BHC21	1 5/16	25	
BHC23	1 7/16	25	
BHC24	1 1/2	25	
BHC26	1 5/8	25	
BHC28	1 3/4	25	



**CALL - 1 (800) 723-2826**

## BATTERY BOLTS

ZINC PLATED

Line: 1559-00



PART NUMBER	SIZE	QTY/BX	LIST PRICE
PNB05040	5/16 X 1 1/4	50	

## HIGH COLLAR BATTERY NUTS

ZINC PLATED

Line: 1560-00



PART NUMBER	SIZE	QTY/BX	LIST PRICE
PPB05	5/16-18	50	

## BATTERY HOLD DOWN BOLTS

ZINC PLATED

Line: 1564-00



PART NUMBER	SIZE	QTY/BX	LIST PRICE
PRB05384	5/16 X 12	1	

## BATTERY HOLD DOWN BOLTS

ROUND J" HOOK - ZINC PLATED

Line: 1564-05



PART NUMBER	SIZE	QTY/BX	LIST PRICE
PRB04160MC	1/4-20 X 5 W/NT&W	2	
PRB04160MCP	1/4-20 X 5 W/NT&W	300	
PRB04296MC	1/4-20 X 9 1/4 W/NT&W	2	
PRB04296MCP	1/4-20 X 9 1/4 W/NT&W	200	
PRB05216MC	5/16-18 X 6 3/4 W/NT&W	2	
PRB05216MCP	5/16-18 X 6 3/4 W/NT&W	150	
PRB05330RDMC	5/16-18 X 10 5/16 NT&W	2	
PRB05330RDMCM	5/16-18 X 10 5/16 NT&W	100	

## BATTERY HOLD DOWN BOLTS

FLAT J" HOOK - ZINC PLATED

Line: 1564-06



PART NUMBER	SIZE	QTY/BX	LIST PRICE
PRB04152MC	1/4-20 X 4 3/4 W/NT&W	2	
PRB04152MCP	1/4-20 X 4 3/4 W/NT&W	300	
PRB04288MC	1/4-20 X 9 W/NT&W	2	
PRB04288MCP	1/4-20 X 9 W/NT&W	200	
PRB05188MC	5/16-18 X 5 7/8 W/NT&W	2	
PRB05188MCP	5/16-18 X 5 7/8 W/NT&W	150	
PRB05330MC	5/16-18 X 10 5/16 NT&W	2	
PRB05330MCP	5/16-18 X 10 5/16 NT&W	100	
PRB06320MC	3/8-16 X 10 W/NT&W	2	
PRB06320MCP	3/8-16 X 10 W/NT&W	80	

## 3M ELEC SELF SEAL INSULATING MASTIC

Line: 1567-10



PART NUMBER	SIZE	QTY/BX	LIST PRICE
ADE6147	2 1/2 X 10 FT ROLLS	1	
ADE6149	2 1/2 X 2 1/2 PATCH	25	

## ELECTRICAL TAPE

Line: 1568-00



PART NUMBER	SIZE	QTY/BX	LIST PRICE
PTB35RED	#35-RED 3M 10810	10	
PTB1700	3M ECOMONY	1	
PTB130C	3/4 X 30 FT SPLICE	1	
PTB27-3M	3/4 X 66 FT (GLASS TAPE)	1	
PTB33-3M	33-3M 3/4 X 44FT	1	
PTB33-3M66FT	33-3M (66FT)	1	
PTB1700-2Q	3/4 X 20 YD (2Q)	1	
PTB33-FT	3/4 X 60 FRICTION	1	
PTB130C15	1 1/2 X 30FT SPLICE	1	
PTB130CX	2 X 30 FT RUB SPLICE	1	



### ELEK-TRO EMERY CLOTH

ROLL UNITS

Line: 1568-01



PART NUMBER	SIZE	QTY/BX	LIST PRICE
JJP05020	60 GRIT 1 1/2 X 50 YARDS	1	
JJP050202	60 GRIT 2 X 50 YARDS	1	
JJP05030	80 GRIT 1 1/2 X 50 YARDS	1	
JJP050302	80 GRIT 2 X 50 YARDS	1	
JJP05067	80 GRIT SCREEN 1 1/2 X 25 YARDS	1	
JJP05029	100 GRIT 1 1/2 X 50 YARDS	1	
JJP050292	100 GRIT 2 X 50 YARDS	1	
JJP05028	120 GRIT 1 1/2 X 50 YARDS	1	
JJP050282	120 GRIT 2 X 50 YARDS	1	
JJP05069	120 GRIT SCREEN 1 1/2 X 25 YARDS	1	
JJP050692	120 GRIT SCREEN 2 X 25 YARDS	1	
JJP05027	150 GRIT 1 1/2 X 50 YARDS	1	
JJP050272	150 GRIT 2 X 50 YARDS	1	
JJP05026	180 GRIT 1 1/2 X 50 YARDS	1	
JJP050262	180 GRIT 2 X 50 YARDS	1	
JJP05071	180 GRIT SCREEN 1 1/2 X 25 YARDS	1	
JJP05025	220 GRIT 1 1/2 X 50 YARDS	1	
JJP050252	220 GRIT 2 X 50 YARDS	1	
JJP05024	240 GRIT 1 1/2 X 50 YARDS	1	
JJP050242	240 GRIT 2 X 50 YARDS	1	
JJP05023	280 GRIT 1 1/2 X 50 YARDS	1	
JJP050232	280 GRIT 2 X 50 YARDS	1	
JJP05022	320 GRIT 1 1/2 X 50 YARDS	1	
JJP050222	320 GRIT 2 X 50 YARDS	1	
JJP05021	400 GRIT 1 1/2 X 50 YARDS	1	
JJP050212	400 GRIT 2 X 50 YARDS	1	

### INDUSTRIAL TAPES (DUCT TAPE)

Line: 1568-02



PART NUMBER	SIZE	QTY/BX	LIST PRICE
PTB270-3M	2 X 60YD 3M (#3939)	1	
PTB370-2	2 X 60YD 10/MIL DUCT	1	
PTB370-2Q	2 X 60YD (2Q) DUCT	1	

### TEFLON SEALING TAPE - QUALITY GRADE

Line: 1570-00



PART NUMBER	SIZE	QTY/BX	LIST PRICE
PUB08288	1/2 X 260 FT	10	
PUB12288	3/4 X 260 FT	5	

### TEFLON SEALING TAPE - ECONOMY GRADE

Line: 1571-00



PART NUMBER	SIZE	QTY/BX	LIST PRICE
HVD08260	1/2 X 260 FT	10	
HVD08520	1/2 X 520 FT	5	
HVD12520	3/4 X 520 FT	5	

### SAFE-T-LOCK LOCKING SEALANTS

Line: 1572-00



PART NUMBER	SIZE	QTY/BX	LIST PRICE
PVBHS	50CC HYDRAULIC SEAL	1	
PVBPFS	50CC REDI FORM GASKET	1	
PVBPRIMER	4.25 OZ. PRIMER N/T	1	
PVBR01	50CC PRESS FIT HIGH STR. (GREEN)	1	
PVBR20	RET SLIP HI-TEMP 10ML BTL	1	
PVBR41	50CC SLIP FIT HIGH STR. (GREEN)	1	
PVBR80	50CC APPL VERY HIGH STR. (GREEN)	1	
PVBS90	50CC ROUGH SURFACE HI STR GREEN)	1	
PVBSA5	50GM STRUCTURAL ADHESIVE	1	
PVBSA5ACT	1.75 OZ/SA-5 ACTIVATE	1	
PVBT22	50CC ALL THD LOW STR. (PURPLE)	1	
PVBT41	50CC SC LK MED STR. (BLUE)	1	
PVBT42	50CC GEN PURP MED STR. (BLUE)	1	
PVBT42S	10CC GEN PURP MED STR. (BLUE)	1	
PVBT62S	10CC STUD BOLT HIGH STR. (RED)	1	
PVBT62	50CC STUD BOLT HIGH STR. (RED)	1	
PVBT70S	10CC NUT LOCK HIGH STR. (RED)	1	
PVBT70	50CC NUT LOCK HIGH STR. (RED)	1	
PVBT77	50CC STUD LOK HIGH STR. (RED)	1	
PVBTPS	50CC TEFL PIPE SEAL	1	
PWBNDVIBTITE	30 CC VIBRA TITE	1	

## SAF-T-LOK INSTANT BONDER

CYANOACRYLATE

Line: 1572-01



PART NUMBER	SIZE	QTY/BX	LIST PRICE
AMMIB45	THIN/VS 1.OZ (#44531)	1	
AMMIB5	1 OZ (#40531) VERY THIN	1	
AMMIB45S	3GM BTL (#44501) VERY THIN	1	
AMMIBGEL	20GM (#44022) BOND GEL	1	

## ANTI-SEEZ CHEMICAL PRODUCTS

SAF-T-LOK BRAND

Line: 1572-10



PART NUMBER	SIZE	QTY/BX	LIST PRICE
PWB51286	12 OZ L/T NICKEL AEROSAL	12	
PWBFBDBT8	8 OZ FOOD GRADE W/TEFLON	1	
PWBNSW160	14 OZ FD14 FOOD GRADE	1	
PWBNSA16	12 OZ SPRAY CAN AEROSAL	1	
PWBNS160	1 LB CAN (#SL-16 REG.)	1	
PWBNS168	8 LB CAN (#SL-8B)	1	
PWBNSBT8	8 OZ BRUSH TOP CAN	1	
PWBNSBT8C	8 OZ BRUSH TOP COPPER	1	
PWBNSBT8N	8 OZ BRUSH TOP NICKEL	1	
PWBNSBT16	1 LB BRUSH TOP CAN	1	
PWBNSBT16C	1 LB BRUSHTOP COPPER	1	
PWBNSBT16N	1 LB BRUSH TOP NICKEL	1	
PWBPSBT8	8 OZ BRUSH TFE PIPE SEALANT	1	
PWBPSBT16	16 OZ BRUSH TFE PIPE SEALANT	1	
PWBSC1	1 LB CARTRIDGE	12	

## SILICONE RUBBER SEALANT (TUBES)

Line: 1572-11



PART NUMBER	SIZE	QTY/BX	LIST PRICE
PWB848BK	BLACK 3 OZ	1	
PWB9732BK	BLACK 10.3	1	
PWB848BL	BLUE 3 OZ	1	
PWB9732BL	BLUE 10.3	1	
PWB848CL	CLEAR 3 OZ	1	
PWB9732CL	CLEAR 10.3OZ	1	
PWB848RD	HI-TEMP RED 3 OZ	1	
PWB9736RD	HI-TEMP RED 10.3 OZ	1	
PWB848WH	WHITE 3 OZ	1	
PWB9732WH	WHITE 10.3 OZ	1	

## CRC CHEMICAL PRODUCTS

AND ADDITIONAL BRAND NAMES

Line: 1572-12



PART NUMBER	SIZE	QTY/BX	LIST PRICE
PWB0019A	STARTING FLUID (M3515)	1	
PWB0050A	19 OZ BRAKE CLEAN (#05089)	1	
PWB02018	20 OZ LECTRA CLEAN	1	
PWB02026	11 OZ BATTERY CLEANER (#03176)	1	
PWB03005	16 OZ 3-36 CLEAN LUB	1	
PWB03006	1 GAL 3-36 CLEAN LUB	1	
PWB03017	12 OZ GASKET REMOVER	1	
PWB03020	13 OZ KNOCK'ER LOOSE	1	
PWB03030	14 OZ-H-D SILICONE	1	
PWB03040	14 OZ FOOD GRADE SILICONE LUB	1	
PWB03045	16 OZ. IND POWER LUBE	1	
PWB03050	16 OZ CHAIN LUBE	1	
PWB03055	3M/77 24 OZ ADHESIVE AEROSAL	1	
PWB03060	11 OZ PENETRATING OIL	1	
PWB03065	9 OZ BELT DRESSING	1	
PWB03070	15 OZ CONTACT CLEANER	1	
PWB03074	15 OZ ZINC/GALV (#18412)	1	
PWB03079	16 OZ AEROSAL RED GREASE	1	
PWB03080	13 OZ CRC WHITE LUBRICANT	1	
PWB03084	16 OZ DRY MOLY LUBRICANT	1	
PWB03095	19 OZ HEAVY DUTY DEGREASER	1	
PWB03096	1 GAL HEAVY DUTY DEGREASER	1	
PWB03110	20 OZ SUPER DEGREASER	1	
PWB03130	16 OZ QD CONTACT CLEANER	1	
PWB03150	16 OZ N/CFC CONTACT CLEANER	1	
PWB03175	12 OZ BATTERY TERM PROTECTOR	1	
PWB03180	19 OZ QUICK CLEAN	1	
PWB03190	16 OZ PF CONTACT CLEANER	1	
PWB03262	14 OZ-STOR-LUB SP350	1	
PWB03282	14 OZ SOF-SEAL SP400	1	
PWB03400	16 OZ TRUE TAP HD CUT FLUID	12	
PWB03441	TRUETAP AQUA CUT.FL.	1	
PWB05018	20 OZ LECTRA-MOTIVE	1	
PWB05061	12 OZ FUEL INJECTION CLEANER	1	
PWB05079	12 OZ NET CARB CLEANER	1	
PWB05088	15 OZ NON-CLR BRAKE CLEAN	1	
PWB05089T	20 OZ BRAKE CLEAN W/TRIGGER	1	
PWB05086	5 GL NON-CLR BRAKE CLEAN	1	
PWB05087	55 GL NON-CLR BRAKE CLEAN	1	

(continued...)

**CRC CHEMICAL PRODUCTS (cont.)**

AND ADDITIONAL BRAND NAMES

Line: 1572-12



PART NUMBER	SIZE	QTY/BX	LIST PRICE
PWB05343	12 OZ GAS TREATMENT	1	
PWB05346	12 OZ SILOO ICE-OFF	1	
PWB0955	1 GAL FAST ORANGE HAND CLEANER	1	
PWB11310	14 OZ MUL-PUR GREASE	1	
PWB1336	1QT GASK.LUBE (PVC)	1	
PWB14001	16 OZ WASP/HORNET SPRAY	1	
PWB14005	20 OZ NATURAL DEGREASER	1	
PWB14011	8 OZ INSECT REPELLENT	1	
PWB14014	16 OZ SPRAYER (#14021)	1	
PWB14016	32 OZ SURE SHOT UNIT SPRAY GUN	1	
PWB14045	28 OZ HYDRO CLEANER	1	
PWB14055	8 OZ SILICONE CLEAR CHZ/WHIZ	1	
PWB14056	8 OZ SILICONE WHITE CHZ/WHIZ	1	
PWB14057	8 OZ SILICONE BLUE CHZ/WHIZ	1	
PWB14059	8 OZ SILICONE RED CHZ/WHIZ	1	
PWB14072	8 OZ SILICONE BLACK CHZ/WHIZ	1	
PWB140715	.7 OZ MIN MEND EPOXY	1	
PWB14077	16 OZ AEROSOL FOAM	1	
PWB14085	12 OZ AEROSOL DUSTER	1	
PWB14400	20 OZ HYDRO FOAM CLEANER	1	
PWB14412	20 OZ AMMON GLS CLEANER	1	
PWB14430	20 OZ GERMICIDAL CLEANER	1	
PWB14853	3M SCOT/KOTE ELE/COAT	1	
PWB18000	16 OZ S/RED SPR/PAINT	1	
PWB18001	16 OZ YELLOW SPR/PAINT	1	
PWB18002	16 OZ BLUE SPRAY PAINT	1	
PWB18004	16 OZ ORANGE SPRAY PAINT	1	
PWB18005	16 OZ GLOSS BLACK SPRAY PAINT	1	
PWB18006	16 OZ GLOSS WHITE SPRAY PAINT	1	
PWB18008	16 OZ FLAT BLACK SPRAY PAINT	6	
PWB18010	16 OZ FLAT GREEN SPRAY PAINT	1	
PWB18011	16 OZ DARK GRAY SPRAY PAINT	1	
PWB18014	10 OZ BOX RE-NU	1	
PWB18101	20 OZ OSHA/YELLOW SPRAY PAINT	1	
PWB18151	20 OZ RED RUST PROOF PRIMER	1	
PWB18201	20 OZ CAUTION YELLOW SPRAY PAINT	1	
PWB18301	18 OZ YELLOW STRIP & TRAFFIC PAINT	1	
PWB18411	16 OZ CLEAR URETH SEAL CT	1	
PWB401612	12 OZ COPPER GASKET COMPOUND	1	

(continued...)

**CRC CHEMICAL PRODUCTS (cont.)**

AND ADDITIONAL BRAND NAMES

Line: 1572-12



PART NUMBER	SIZE	QTY/BX	LIST PRICE
PWB7336S	1 QUART PVC CLEANER	1	
PWB8036S	1 QUART PVC PRIMER	1	
PWB903M	3M/90 INST BOND 24 OZ	1	
PWB8TT4	4.5 OZ BATT TERM PROTECTOR	1	
PWB8TC4	5 OZ BATTERY TERMINAL CLEANER	1	
PWBDE1	12 OZ GUNK DE-ICER	1	
PWBEB1	DEGREASER AEROSOL	1	
PWBG771-2	2 OZ TUBE CUTTING TOOL LUB	1	
PWBG771-8	8 OZ TUBE CUTTING TOOL LUB	1	
PWBG771-8J	8 OZ JAR CUTTING TOOL LUB	1	
PWBG61	19 OZ GLASS CLEANER	1	
PWBHAYNES	9 OZ USP LIQUID PETROLEUM FOOD	1	
PWBL666	1 LB TUB WH LITH GREASE	1	
PWBL716	15 OZ CHAIN LUBRICANT	1	
PWBM4412	12 OZ H.D.BRAKE FLUID	1	
PWBM4824	CARB CLEANER SPRAY	1	
PWBM516	16 OZ WINDSHIELD SOLVENT	1	
PWBM720	20 OZ M720 BRAKE CLEANER	1	
PWBM914	H D SILICONE SPRAY	1	
PWBML2S	12 OZ CHAIN LUBE	1	
PWBNM1	20 OZ CONTACT CLEANER	1	
PWBRPA12	12 OZ RUST PREVENT	1	
PWBSL1217	7 LB LC HAND CLEANER	1	
PWB4-404ATC	4 OZ AIR TOOL OIL	1	
PWBSL2531	15 OZ BTL AIRTOOL OIL	1	
PWBSL2533	1 GAL AIR TOOL OIL	1	
PWBSL3150	14 OZ SUPERWHITE LITHIUM	1	
PWBSL3190	14 OZ CART RED GREASE	1	
PWBSL3310	14 OZ CT WHITE BEARING GREASE	1	
PWBSL3330	14 OZ MOLY-GRAPH LITHIUM	1	
PWBSL4117	DISPENSER - 7LB CAN	1	

**CALL: (800) 723-2826**

## HB1 SPRAY TAP CUTTING FLUID

Line: 1572-13



PART NUMBER	SIZE	QTY/BX	LIST PRICE
JXNHB1SC	PINT/SPOUT CAN	1	
JXNHB1A	16 OZ SPRAY CRC14050	1	

## PB BLASTER

Line: 1572-14



PART NUMBER	SIZE	QTY/BX	LIST PRICE
PWB16-PB	13.26 OZ	1	

## SEYMOUR AEROSOL PRODUCTS

PAINTS, LUBES & CHEMICALS

Line: 1572-15



PART NUMBER	SIZE	QTY/BX	LIST PRICE
SEY1010	GAC FLAT BLACK	1	
SEY1012	GAC FLAT WHITE	1	
SEY1015	GAC GRAY PRIMER	1	
SEY102	GAC GLOSS WHITE	1	
SEY103	GAC GLOSS BLACK	1	
SEY1034	GAC GLOSS YELLOW	1	
SEY104	GAC GLOSS CHERRY RED	1	
SEY1056	GAC GLOSS BLUE	1	
SEY107	GAC GLOS SMOKE GRAY	1	
SEY108	GAC GLOSS HUNT GREEN	1	
SEY1124	FNQ SEMI-GLOSS BLACK	6	
SEY16214	INT.HARVESTER RED HIGH SOLID	1	
SEY16224	CASE/J.D. GREEN HIGH SOLID	1	
SEY16266	J.DEER NEW YELLOW HIGH SOLID	1	
SEY16268	J.DEER NEW GREEN HIGH SOLID	1	
SEY16286	SCHOOL BUS YELLOW HIGH SOLID	6	
SEY16671	INVERTED TIP SAFETY RED	1	
SEY20020	GLASS CLEANER	1	
SEY20654	FLORESCENT RED MARKER PAINT	1	
SEY20679	FLORESCENT PINK MARKER PAINT	1	
SEY6201407	RED/OXIDE PRIMER HIGH SOLID	1	
SEY6201411	ALUMINUM HIGH SOLID	1	
SEY6201412	FLAT WHITE HIGH SOLID	1	
SEY6201413	GLOSS WHITE HIGH SOLID	1	

(continued...)

## SEYMOUR AEROSOL PRODUCTS (cont.)

PAINTS, LUBES & CHEMICALS



Line: 1572-15

PART NUMBER	SIZE	QTY/BX	LIST PRICE
SEY6201415	GLOSS BLACK HIGH SOLID	1	
SEY6201416	GRAY(ANSI61) HIGH SOLID	1	
SEY6201417	DARK MACHINE GRAY HIGH SOLID	1	
SEY6201418	LIGHT MACHINE GRAY HIGH SOLID	1	
SEY6201419	SAFETY YELLOW HIGH SOLID	1	
SEY6201423	SAFETY RED HIGH SOLID	1	
SEY6201426	DEEP BLUE HIGH SOLID	1	
SEY6201427	SAFETY BLUE HIGH SOLID	1	
SEY6201431	LIGHT GRAY PRIMER HIGH SOLID	1	
SEY6201433	FLAT BLACK HIGH SOLID	1	
SEY6201447	CUMMINS BEIGE HIGH SOLID	1	
SEY6201451	SAFETY ORANGE HIGH SOLID	1	
SEY6201452	SAFETY GREEN HIGH SOLID	1	
SEY6201460	STAINLESS STEEL HIGH SOLID	1	
SEY6201500	SILICONE LUBE	1	
SEY6201501	OPEN GEAR LUBE	1	
SEY6201502	CHAIN & CABLE LUBE	1	
SEY6201505	DRY MOLY LUBE	1	
SEY6201526	CONTACT CLEANER E/M	1	
SEY6201536	CARB & CHOKE CLEANER	1	
SEY6201539	620-1538 SPRAY ADHESIVE	1	
SEY6201541	CORROSION INHIBITOR	1	
SEY6201543	PENETRATING OIL	1	
SEY6201548	NON/CLOR. BRAKE PART CLEANER	1	
SEY6201557	TOOL CUTTING OIL	1	
SEY6201568	CLEANER / DEGREASER	1	

**INSERT COIL REPAIR KITS**



Line: 1574-00

PART NUMBER	SIZE	QTY/BX	LIST PRICE
WKB5401-02	2/56	1	
WKB5401-04	4/40	1	
WKB5402-04	4/48	1	
WKB5401-05	5/40	1	
WKB5401-06	6/32	1	
WKB5402-06	6/40	1	
WKB5401-2	8/32	1	
WKB5402-2	8/36	1	
WKB5401-3	10/24	1	
WKB5402-3	10/32	1	
WKB5401-1	12/24	1	
WKB5402-1	12/28	1	
WKB5401-4	1/4-20	1	
WKB5402-4	1/4-28	1	
WKB5401-5	5/16-18	1	
WKB5402-5	5/16-24	1	
WKB5401-6	3/8-16	1	
WKB5402-6	3/8-24	1	
WKB5401-7	7/16-14	1	
WKB5402-7	7/16-20	1	
WKB5401-8	1/2-13	1	
WKB5402-8	1/2-20	1	
WKB5401-9	9/16-12	1	
WKB5402-9	9/16-18	1	
WKB5401-10	5/8-11	1	
WKB5402-10	5/8-18	1	
WKB5401-12	3/4-10	1	
WKB5402-12	3/4-16	1	
WKB5521-14	7/8-9	1	
WKB5528-14	7/8-14	1	
WKB5521-16	1"-8	1	
WKB5528-161	1"-12	1	
WKB5528-16	1"-14	1	
WKB5521-18	1 1/8-7	1	
WKB5528-18	1 1/8-12	1	
WKB5521-20	1 1/4-7	1	
WKB5528-20	1 1/4-12	1	
WKB5521-22	1 3/8-6	1	
WKB5528-22	1 3/8-12	1	
WKB5521-24	1 1/2-6	1	
WKB5528-24	1 1/2-12	1	

**INSERT COIL METRIC REPAIR KITS**



Line: 1574-01

PART NUMBER	SIZE	QTY/BX	LIST PRICE
ACP5403-2	M2 X 0.4	1	
ACP5403-25	M2.5 X 0.45	1	
ACP5403-3	M3 X 0.5	1	
ACP5403-35	M3.5 X 0.6	1	
ACP5403-4	M4 X 0.7	1	
ACP5403-5	M5 X 0.8	1	
ACP5403-6	M6 X 1.0	1	
ACP5403-7	M7 X 1.0	1	
ACP5404-8	M8 X 1.0	1	
ACP5403-8	M8 X 1.25	1	
ACP5403-9	M9 X 1.25	1	
ACP5404-10	M10 X 1.0	1	
ACP5405-10	M10 X 1.25	1	
ACP5403-10	M10 X 1.5	1	
ACP5403-11	M11 X 1.5	1	
ACP5404-12	M12 X 1.0	1	
ACP5405-12	M12 X 1.25	1	
ACP5406-12	M12 X 1.5	1	
ACP5403-12	M12 X 1.75	1	
ACP04031	M14-1.0	1	
ACP38141-14	M14-1.25	1	
ACP5406-14	M14 X 1.5	1	
ACP5403-14	M14 X 2.0	1	
ACP5406-16	M16 X 1.5	1	
ACP5403-16	M16 X 2.0	1	
ACP5406-18	M18 X 1.5	1	
ACP37180-18	M18 X 2.0	1	
ACP5403-18	M18 X 2.5	1	
ACP38200-20	M20 X 1.5	1	
ACP37200-20	M20 X 2.0	1	
ACP5403-20	M20 X 2.5	1	
ACP04042	M22 X 1.5	1	
ACP04041	M22 X 2.0	1	
ACP04040	M22 X 2.5	1	
ACP04045	M24 X 1.5	1	
ACP37240-24	M24 X 2.0	1	
ACP35240-24	M24 X 3.0	1	
ACP35300-30	M30 X 3.0	1	
ACP35300-3	M30 X 3.5	1	

(continued...)

**CALL: (800) 723-2826**

**INSERT COIL METRIC REPAIR KITS (cont.)**

Line: 1574-01



PART NUMBER	SIZE	QTY/BX	LIST PRICE
ACP5523-12	M12 SPARK PLUG KIT	1	
ACP5523-14	M14 SPARK PLUG KIT	1	
ACP5523-18	M18 SPARK PLUG KIT	1	

**INSERT COIL MASTER THREAD REPAIR KITS**

Line: 1574-02



PART NUMBER	SIZE	QTY/BX	LIST PRICE
ACT4083	M6-M14 W/SPARK PLUG M14	1	
ACT4937150	M5-12MET COURSE THREAD	1	
ACT4934UNC	1/4 THRU 1/2 UNC	1	
ACT4936UNF	1/4 THRU 1/2 UNF	1	

**INSERT COILS NC/NF**

SHORT - MEDIUM - LONG

Line: 1575-00



PART NUMBER	SIZE	QTY/BX	LIST PRICE
WLB1185-02S	2/56 X .086	12	
WMB1185-02M	2/56 X .129	12	
WNB1185-02L	2/56 X .172	12	
WLB1185-031S	3/48 X .099	12	
WMB1185-031M	3/48 X .148	12	
WNB1185-031L	3/48 X .198	12	
WLB1191-03S	3/56 X .099	12	
WMB1191-03M	3/56 X .148	12	
WNB1191-03L	3/56 X .198	12	
WLB1185-04S	4/40 X .112	12	
WMB1185-04M	4/40 X .168	12	
WNB1185-04L	4/40 X .224	12	
WNB209C04336	4/40 X .0336 X-LONG (209C)	6	
WLB1191-041S	4/48 X .112	12	
WMB1191-041M	4/48 X .168	12	
WNB1191-041L	4/48 X .224	12	
WLB1185-05S	5/40 X .125	12	
WMB1185-05M	5/40 X .188	12	
WNB1185-05L	5/40 X .250	12	
WLB1185-06S	6/32 X .138	12	
WMB1185-06M	6/32 X .207	12	
WNB1185-06L	6/32 X .276	12	
WNB209C06414	6/32 X .414 X-LONG (209C)	6	

(continued...)

**INSERT COILS NC/NF (cont.)**

SHORT - MEDIUM - LONG

Line: 1575-00



PART NUMBER	SIZE	QTY/BX	LIST PRICE
WLB1191-06S	6/40 X .138	12	
WMB1191-06M	6/40 X .207	12	
WNB1191-06L	6/40 X .276	12	
WLB1185-2S	8/32 X .164	12	
WMB1185-2M	8/32 X .246	12	
WNB1185-2L	8/32 X .328	12	
WLB1191-2S	8/36 X .164	12	
WMB1191-2M	8/36 X .246	12	
WNB1191-2L	8/36 X .328	12	
WLB1185-3S	10/24 X .190	12	
WMB1185-3M	10/24 X .285	12	
WNB1185-3L	10/24 X .380	12	
WLB1191-3S	10/32 X .190	12	
WMB1191-3M	10/32 X .285	12	
WNB1191-3L	10/32 X .380	12	
WLB1185-1S	12/24 X .216	12	
WMB1185-1M	12/24 X .324	25	
WNB1185-1L	12/24 X .432	25	
WLB1185-4S	1/4-20 X .250	12	
WMB1185-4M	1/4-20 X .375	12	
WNB1185-4L	1/4-20 X .500	12	
WNB208C4625	1/4-20 X .625 X-LONG	6	
WLB1191-4S	1/4-28 X .250	12	
WMB1191-4M	1/4-28 X .375	12	
WNB1191-4L	1/4-28 X .500	12	
WLB1185-5S	5/16-18 X .312	12	
WMB1185-5M	5/16-18 X .468	12	
WNB1185-5L	5/16-18 X .625	12	
WNB1185-5XL	5/16-18 X.780 X-LONG	25	
WNB208C5938	5/16-18 X .938 X-LONG	6	
WLB1191-5S	5/16-24 X .312	12	
WMB1191-5M	5/16-24 X .469	12	
WNB1191-5L	5/16-24 X .625	12	
WLB1185-6S	3/8-16 X .375	12	
WMB1185-6M	3/8-16 X .563	12	
WNB1185-6L	3/8-16 X .750	12	
WNB1185-6XL	3/8-16 X.938 X-LONG	12	
WLB1191-6S	3/8-24 X .375	12	
WMB1191-6M	3/8-24 X .562	12	

(continued...)

**INSERT COILS NC/NF (cont.)**

SHORT - MEDIUM - LONG

Line: 1575-00



PART NUMBER	SIZE	QTY/BX	LIST PRICE
WNB1191-6L	3/8-24 X .750	12	
WLB1185-7S	7/16-14 X .438	6	
WMB1185-7M	7/16-14 X .657	6	
WNB1185-7L	7/16-14 X .875	6	
WLB1191-7S	7/16-20 X .438	6	
WMB1191-7M	7/16-20 X .656	6	
WNB1191-7L	7/16-20 X .875	6	
WLB1185-8S	1/2-13 X .500	6	
WMB1185-8M	1/2-13 X .750	6	
WNB1185-8L	1/2-13 X 1.000	6	
WLB1191-8S	1/2-20 X .500	6	
WMB1191-8M	1/2-20 X .750	6	
WNB1191-8L	1/2-20 X 1.000	6	
WLB1185-9S	9/16-12 X .562	6	
WMB1185-9M	9/16-12 X .844	6	
WNB1185-9L	9/16-12 X 1.125	6	
WLB1191-9S	9/16-18 X .562	6	
WMB1191-9M	9/16-18 X .844	6	
WNB1191-9L	9/16-18 X 1.125	6	
WLB1185-10S	5/8-11 X .625	6	
WMB1185-10M	5/8-11 X .938	6	
WNB1185-10L	5/8-11 X 1.250	6	
WLB1191-10S	5/8-18 X .625	6	
WMB1191-10M	5/8-18 X .938	6	
WNB1191-10L	5/8-18 X 1.250	6	
WLB1185-12S	3/4-10 X .750	4	
WMB1185-12M	3/4-10 X 1.125	4	
WNB1185-12L	3/4-10 X 1.500	4	
WLB1191-12S	3/4-16 X .750	4	
WMB1191-12M	3/4-16 X 1.125	4	
WNB1191-12L	3/4-16 X 1.500	4	
WLB1185-14S	7/8-9 X .875	1	
WMB1185-14M	7/8-9 X 1.313	1	
WNB1185-14L	7/8-9 X 1.750	1	
WLB1191-14S	7/8-14 X .875	1	
WMB1191-14M	7/8-14 X 1.313	1	
WNB1191-14L	7/8-14 X 1.750	1	
WLB1185-16S	1-8 X 1.000	1	
WMB1185-16M	1-8 X 1.500	1	

(continued...)

**INSERT COILS NC/NF (cont.)**

SHORT - MEDIUM - LONG

Line: 1575-00



PART NUMBER	SIZE	QTY/BX	LIST PRICE
WNB1185-16L	1-8 X 2.000	1	
WLB1191-116S	1-12 X 1.000	1	
WMB1191-116M	1-12 X 1.500	1	
WNB1191-116L	1-12 X 2.000	1	
WLB1191-16S	1-14 X 1.000	1	
WMB1191-16M	1-14 X 1.500	1	
WNB1191-16L	1-14 X 2.000	1	
WLB1185-18S	1 1/8-7 X 1.125	1	
WMB1185-18M	1 1/8-7 X 1.688	1	
WNB1185-18L	1 1/8-7 X 2.250	1	
WLB1191-18S	1 1/8-12 X 1.125	1	
WMB1191-18M	1 1/8-12 X 1.688	1	
WNB1191-18L	1 1/8-12 X 2.250	1	
WLB1185-20S	1 1/4-7 X 1.250	1	
WMB1181-20M	1 1/4-7 X 1.875	1	
WNB1185-20L	1 1/4-7 X 2.500	1	
WMB20188UN8M	1 1/4-8 X 1.880	5	
WLB1191-20S	1 1/4-12 X 1.250	1	
WMB1191-20M	1 1/4-12 X 1.875	1	
WNB1191-20L	1 1/4-12 X 2.500	1	
WLB1185-22S	1 3/8-6 X 1.375	1	
WMB1185-22M	1 3/8-6 X 2.062	1	
WNB1185-22L	1 3/8-6 X 2.750	1	
WLB1191-22S	1 3/8-12 X 1.375	1	
WMB1191-22M	1 3/8-12 X 2.062	1	
WNB1191-22L	1 3/8-12 X 2.750	1	
WLB1185-24S	1 1/2-6 X 1.500	1	
WMB1185-24M	1 1/2-6 X 2.250	1	
WNB1185-24L	1 1/2-6 X 3.000	1	
WLB1191-24S	1 1/2-12 X 1.500	1	
WMB1191-24M	1 1/2-12 X 2.250	1	
WNB1191-24L	1 1/2-12 X 3.000	1	
WLB24150UN8S	1 1/2-8 X 1.50	10	
WMB24225UN8M	1 1/2-8 X 2.250	1	
WLB28175UN8S	1 3/4-8 X 1.75	5	
WMB28263UN8M	1 3/4-8 X 2.63	10	

**CALL: (800) 723-2826**

## METRIC INSERT COILS

Line: 1575-01



PART NUMBER	SIZE	QTY/BX	LIST PRICE
AAN1084-2S	M2-0.4 x 2mm	12	
AAN7302-2M	M2-0.4 x 3mm	12	
AAN7402-2L	M2-0.4 x 4mm	12	
AAN1084-2-2S	M2.2-0.45 x 2.2mm	12	
AAN1084-2-2M	M2.2-0.45 x 3.3mm	12	
AAN1084-2-2L	M2.2-0.45 x 4.4mm	12	
AAN1084-2-5S	M2.5-0.45 x 2.5mm	12	
AAN1084-2-5M	M2.5-0.45 x 3.75mm	12	
AAN1084-2-5L	M2.5-0.45 x 5.0mm	12	
AAN1084-3S	M3-0.5 x 3.0mm	12	
AAN1084-3M	M3-0.5 x 4.5mm	12	
AAN1084-3L	M3-0.5 x 6.0mm	12	
AAN1084-3-5S	M3.5-0.6 x 3.5mm	12	
AAN1084-3-5M	M3.5-0.6 x 5.25mm	12	
AAN1084-3-5L	M3.5-0.6 x 7.0mm	12	
AAN1084-4S	M4-0.7 x 4.0mm	12	
AAN1084-4M	M4-0.7 x 6.0mm	12	
AAN1084-4L	M4-0.7 x 8.0mm	12	
AAN1084-5S	M5-0.8 x 5.0mm	12	
AAN1084-5M	M5-0.8 x 7.5mm	12	
AAN1084-5L	M5-0.8 x 10.0mm	12	
AAN1084-6S	M6-1 x 6.0mm	12	
AAN1084-6M	M6-1 x 9.0mm	12	
AAN1084-6L	M6-1 x 12.0mm	12	
AAN1084-7S	M7-1 x 7.0mm	12	
AAN1084-7M	M7-1 x 10.5mm	12	
AAN1084-7L	M7-1 x 14.0mm	12	
AAN4255-8S	M8-1 x 8.0mm	12	
AAN4255-8M	M8-1 x 12.0mm	12	
AAN4255-8L	M8-1 x 16.0mm	12	
AAN1084-8S	M8-1.25 x 8.0mm	12	
AAN1084-8M	M8-1.25 x 12.0mm	12	
AAN1084-8L	M8-1.25 x 16.0mm	12	
AAN1084-9S	M9-1.25 x 9mm	12	
AAN7313-9M	M9-1.25 x 13.5mm	12	
AAN7413-9L	M9-1.25 x 18mm	12	
AAN4255-10S	M10-1 x 10.0mm	12	
AAN4255-10M	M10-1 x 15.0mm	12	
AAN4255-10L	M10-1 x 20.0mm	12	

(continued...)

## METRIC INSERT COILS (cont.)

Line: 1575-01



PART NUMBER	SIZE	QTY/BX	LIST PRICE
AAN4649-10S	M10-1.25 x 10.0mm	12	
AAN4649-10M	M10-1.25 x 15.0mm	12	
AAN4649-10L	M10-1.25 x 20.0mm	12	
AAN1084-10S	M10-1.5 x 10.0mm	12	
AAN1084-10M	M10-1.5 x 15.0mm	12	
AAN1084-10L	M10-1.5 x 20.0mm	12	
AAN1084-11S	M11-1.5 x 11mm	12	
AAN7319-11M	M11-1.5 x 16.5mm	12	
AAN7419-11L	M11-1.5 x 22mm	6	
AAN1084-11XL	M11-1.5 x 33mm	6	
AAN7224-12S	M12-1.0 x 12mm	12	
AAN7324-12M	M12-1.0 x 18mm	6	
AAN7424-12L	M12-1.0 x 24mm	6	
AAN4649-12S	M12-1.25 x 12mm	6	
AAN4649-12M	M12-1.25 x 18mm	6	
AAN4649-12L	M12-1.25 x 24mm	6	
AAN3745-12S	M12-1.5 x 12mm	6	
AAN3745-12M	M12-1.5 x 18mm	6	
AAN3745-12L	M12-1.5 x 24mm	6	
AAN1084-12S	M12-1.75 x 12mm	6	
AAN1084-12M	M12-1.75 x 18mm	6	
AAN1084-12L	M12-1.75 x 24mm	6	
AAN7231-14S	M14-1.0 x 14mm	6	
AAN7331-14M	M14-1.0 x 21mm	6	
AAN7431-14L	M14-1.0 x 28mm	6	
AAN7227-14S	M14-1.25 x 14mm	6	
AAN7327-14M	M14-1.25 x 21mm	6	
AAN7427-14L	M14-1.25 x 28mm	6	
AAN3745-14S	M14-1.5 x 14mm	6	
AAN3745-14M	M14-1.5 x 21mm	6	
AAN3745-14L	M14-1.5 x 28mm	6	
AAN1084-14S	M14-2.0 x 14mm	6	
AAN1084-14M	M14-2.0 x 21mm	6	
AAN1084-14L	M14-2.0 x 28mm	6	
AAN3745-16S	M16-1.5 x 16mm	6	
AAN3745-16M	M16-1.5 x 24mm	6	
AAN3745-16L	M16-1.5 x 32mm	6	
AAN1084-16S	M16-2.0 x 16mm	6	
AAN1084-16M	M16-2.0 x 24mm	6	

(continued...)



**METRIC INSERT COILS (cont.)**

Line: 1575-01



PART NUMBER	SIZE	QTY/BX	LIST PRICE
AAN1084-16L	M16-2.0 x 32mm	6	
AAN3745-18S	M18-1.5 x 18mm	6	
AAN3745-18M	M18-1.5 x 27mm	6	
AAN3745-18L	M18-1.5 x 36mm	6	
AAN7237-18S	M18-2.0 x 18mm	4	
AAN7337-18M	M18-2.0 x 27mm	6	
AAN7437-18L	M18-2.0 x 36mm	6	
AAN1084-18S	M18-2.5 x 18mm	6	
AAN1084-18M	M18-2.5 x 27mm	6	
AAN1084-18L	M18-2.5 x 36mm	6	
AAN7241-20S	M20-1.5 x 20mm	4	
AAN7341-20M	M20-1.5 x 30mm	4	
AAN7441-20L	M20-1.5 x 40mm	4	
AAN7240-20S	M20-2.0 x 20mm	4	
AAN7340-20M	M20-2.0 x 30mm	4	
AAN7440-20L	M20-2.0 x 40mm	3	
AAN1084-20S	M20-2.5 x 20mm	3	
AAN1084-20M	M20-2.5 x 30mm	3	
AAN1084-20L	M20-2.5 x 40mm	3	
AAN7244-22S	M22-1.5 x 22mm	4	
AAN7344-22M	M22-1.5 x 33mm	4	
AAN7444-22L	M22-1.5 x 44mm	4	
AAN7243-22S	M22-2.0 x 22mm	4	
AAN7343-22M	M22-2.0 x 33mm	4	
AAN7443-22L	M22-2.0 x 44mm	4	
AAN1084-22S	M22 x 2.5 x 22mm	4	
AAN1084-22M	M22 x 2.5 x 33mm	4	
AAN1084-22L	M22 x 2.5 x 44mm	4	
AAN7247-24S	M24-1.5 x 24mm	4	
AAN7347-24M	M24-1.5 x 36mm	4	
AAN7447-24L	M24-1.5 x 48mm	4	
AAN7246-24S	M24-2.0 x 24mm	4	
AAN7346-24M	M24-2.0 x 36mm	4	
AAN7446-24L	M24-2.0 x 48mm	4	
AAN1084-24S	M24-3 x 24mm	4	
AAN1084-24M	M24-3 x 36mm	4	
AAN1084-24L	M24-3 x 48mm	4	

**INSERT COIL SPARK PLUG KIT**

Line: 1575-02



PART NUMBER	SIZE	QTY/BX	LIST PRICE
ACR474-4	10 X 1.0 1/2 RCH	6	
ACR482-1	12 X 1.25 1/2 RCH	6	
ACR482-2	12 X 1.25 3/4 RCH	6	
ACR512	14 X 1.25 3/8 RCH	6	
ACR513-20	14 X 1.25 .472 RCH	6	
ACR513-13	14 X 1.25 1/2 RCH	6	
ACR513-10	14 X 1.25 3/4 RCH	6	
ACR514-6	18 X 1.50 1/2 RCH	6	

**PIPE THREAD INSERT COILS & KITS**

Line: 1575-03



PART NUMBER	SIZE	QTY/BX	LIST PRICE
ACS327-2	1/8-27 TAPER	12	
ACS5407-2	1/8-27 PIPE THD KIT	1	
ACS327-4	1/4-18 TAPER	12	
ACS5407-4	1/4-18 PIPE THD KIT	1	
ACS327-6	3/8-18 TAPER	5	
ACS5407-6	3/8-18 PIPE THD KIT	1	
ACS327-8	1/2-14 TAPER	5	
ACS5407-8	1/2-14 PIPE THD KIT	1	
ACS327-12	3/4-14 TAPER	5	
ACS5407-12	3/4-14 PIPE THD KIT	1	
ACS327-16	1-11 1/2 TAPER	2	
ACS5407-16	1-11 1/2 PIPE THD KIT	1	



**CALL - 1 (800) 723-2826**

**CALL: (800) 723-2826**

## NYLON CABLE TIES - TYTON BRAND

Line: 1587-00



PART NUMBER	SIZE	QTY/BX	LIST PRICE
ZFB-G3	3/32 X 4 T18R BLACK	100	
ZFB-G3W	3/32 X 4 T18R WHITE	100	
ZFBIT18FL	3/32 X 4 NATURAL W/FLAG	200	
ZFBIT18R	3/32 X 4 NATURAL W/TAG	200	
ZFBT181	3/32 X 5 3/4 BLACK	100	
ZFBT181W	3/32 X 5 3/4 NATURAL	100	
ZFBT18MR	#4 SC.10 X 4 1/4 BLACK MOUNT	100	
ZFBT18MRW	#4SC.10 X 4 1/4 WHT E MOUNT	100	
ZFBT30R	.14 X 6 BLACK	100	
ZFBT30RN	.14 X 6 NATURAL	100	
ZFBT40R	.15 X 8 1/2 BNDL	100	
ZFBT30MR	#8 SCREW MOUNT.14 X 6 1/4	100	
ZFBIT50R9	.18 X 8 NATURAL W/TAG	100	
ZFBT50I	.18 X 11 3/4 BLACK	100	
ZFB2651	3/16 X 8 T50R BLACK	100	
ZFB2651BL	3/16 X 8 T50R BLUE	100	
ZFB2651BR	3/16 X 8 T50R BROWN	100	
ZFB2651GRN	3/16 X 8 T50R GREEN	100	
ZFB2651O	3/16 X 8 T50R ORANGE	100	
ZFB2651R	3/16 X 8 T50R RED	100	
ZFB2651V	3/16 X 8 T50R VIOLET	100	
ZFB2651W	3/16 X 8 NATURAL	100	
ZFB2651Y	3/16 X 8 T50R YELLOW	100	
ZFB2652	3/16 X 15 1/2 T50L BLACK	100	
ZFB2652W	3/16 X 15 1/2 T50 WHITE	100	
ZFB2654	3/16 X 8 1/2 T50MR BLACK	100	
ZFB2655	3/16 X 16 T50ML BLACK	100	
ZFBBT100C	.22 X 9 5/8 BUTTON FRAME TY	100	
ZFBT120RSM	16FRM STUD MOUNT TY	50	
ZFBRT150M0X2	5/16X21 RELEASABLE	25	
ZFB2653	5/16 X 15 1/4 T120R BLACK	50	
ZFB2656	5/16 X 16 1/4 T120MR BLACK	50	
ZFB2657	11/32 X 21 T150M0X BLACK	25	
ZFB2657W	11/32X21T150 WHITE	25	
ZFB2658	11/32 X 36 L361750L BLACK	25	
ZFBRT250M0X2	1/2 X 23 RELEASABLE BLACK	25	

## CABLE TIE ACCESSORIES

Line: 1587-01



PART NUMBER	SIZE	QTY/BX	LIST PRICE
ACCNVLLAN	NYLON LANYARDS BLACK	100	
ACCTMK1	CABLE TIE KIT	1	
ACCTWT1	TIE INSTALLATION TOOL	1	

## 4-WAY CABLE TIE MOUNTING BASE

Line: 1587-02



PART NUMBER	SIZE	QTY/BX	LIST PRICE
ADDMB4A	ADHESIVE MOUNT BLACK	25	
ADDMB4AW	ADHESIVE MOUNT WHITE	25	
ADDMB4	#8 SCREW MOUNT BLACK	25	

## STANDARD GRADE NYLON CABLE TIES

Line: 1587-04



PART NUMBER	SIZE	QTY/BX	LIST PRICE
CDNT18MRE	.14 X 6 30LB MOUNT BLACK	100	
CDNT18MRWE	.14 X 6 18LB MOUNT WHITE	100	
CDNT30RE	.14 X 5 3/4 40LB BLACK	100	
CDNT30RNWE	.14 X 5 3/4 40LB NATURAL	100	
CDNG3E	3/32 X 4 18LB BLACK	100	
CDNG3WE	3/32 X 4 18LB WHITE	100	
CDNT181E	3/32 X 6 18LB BLACK	100	
CDNT181WE	3/32 X 6 18LB NATURAL	100	
CDNT50IE	3/16 X 11 1/4 50LB BLACK	100	
CDN2651E	3/16 X 7 1/2 50LB BLACK	100	
CDN2651WE	3/16 X 7 1/2 50LB NATURAL	100	
CDN2652E	3/16 X 14 1/2 50LB BLACK	100	
CDN2652WE	3/16 X 14 1/2 50LB NATURAL	100	
CDN2654E	3/16 X 8 50LB MOUNT BLACK	100	
CDN2654WE	3/16 X 8 50LB MOUNT NATURAL	100	
CDN2655E	3/16 X 16 50LB MOUNT BLACK	100	
CDN2655WE	3/16 X 16 50LB MOUNT NATURAL	100	
CDN2653E	5/16 X 15 120LB LASH BLACK	50	
CDN2656E	5/16 X 16 120LB MOUNT BLACK	100	
CDN2656WE	5/16 X 16 120LB MOUNT NATURAL	100	
CDN2657E	11/32 X 25 175LB LASH BLACK	50	
CDN2658E	11/32 X 37 175LB LASH BLACK	50	
CDN2659WE	11/32 X 48 175LB NATURAL	50	

### LITE DUTY TUBING CLAMP

VINYL COATED  
Line: 1588-00



PART NUMBER	SIZE	QTY/BX	LIST PRICE
ZGB3168	1/4	25	
ZGB3169	5/16	25	
ZGB3170	3/8	25	
ZGB3171	1/2	25	
ZGB3172	5/8	25	
ZGB3173	3/4	25	

### HEAVY DUTY TUBING CLAMP

VINYL COATED  
Line: 1589-00



PART NUMBER	SIZE	QTY/BX	LIST PRICE
ZHB2662	1/4	25	
ZHB2663	5/16	25	
ZHB2664	3/8	25	
ZHB2665	1/2	25	
ZHB2666	5/8	25	
ZHB2667	3/4	25	
ZHB2668	7/8	25	
ZHB2669	1	25	
ZHB2670	1 1/4	25	
ZHB2671	1 1/2	25	
ZHB2672	1 3/4	25	
ZHB2673	2	25	
ZHB2674	3	25	
ZHB2675	4	25	

### NYLON HEAVY DUTY TUBING CLAMP

Line: 1590-00



PART NUMBER	SIZE	QTY/BX	LIST PRICE
ZJB0250	1/4 X 1/2W BLACK	25	
ZJB0312	5/16 OD X 1/2 WIDE	25	
ZJB3420J	3/8 OD X 1/2 WIDE	25	
ZJB3421J	1/2 OD X 1/2 WIDE NATURAL	25	
ZJB3425J	5/8 OD X 1/2 WIDE BLACK	25	
ZJB3426J	7/8 OD X 1/2 WIDE BLACK	1	
ZJB3424J	1 1/4 OD X 1/2 WIDE BLACK	25	

### NYLON TUBING CLAMP

Line: 1591-00



PART NUMBER	SIZE	QTY/BX	LIST PRICE
ZJB02	1/8 NATURAL	25	
ZJB02X	1/8 BLACK	25	
ZJB03X	3/16 ID BLACK	25	
ZJB3410	1/4 BLACK	25	
ZJB3411	5/16 BLACK	25	
ZJB9247A	5/16 X 3/8 WIDE NATURAL	25	
ZJB3412	3/8	25	
ZJB3413	1/2	25	
ZJB3414	5/8	25	
ZJB3415	3/4 OD X 1/2 WIDE	25	
ZJB3415NAT	3/4 OD X 1/2 WIDE NATURAL	25	
ZJB3416	1 OD X 1/2 WIDE	25	
ZJB3416NAT	1 OD X 1/2 WIDE NATURAL	25	

### ALUMINUM TUBING CLAMP

WITH NEOPRENE COVER

Line: 1592-00



PART NUMBER	SIZE	QTY/BX	LIST PRICE
ZKB1910	1/4	25	
ZKB1911	5/16	25	
ZKB1912	3/8	25	
ZKB1913	1/2	25	
ZKB1914	5/8	25	
ZKB1915	3/4	25	
ZKB1916	7/8	25	
ZKB1917	1	25	
ZKB1918	1 1/8	25	
ZKB1919	1 1/4	25	
ZKB1920	1 3/8	25	
ZKB1921	1 1/2	25	

### JIFFY TYPE TUBING CLAMP

Line: 1593-00



PART NUMBER	SIZE	QTY/BX	LIST PRICE
ZKB3160J	1/4	100	
ZKB3161J	5/16	100	
ZKB3162J	3/8	100	
ZKB3163J	1/2	100	
ZKB3164J	5/8	50	
ZKB3165J	3/4	50	
ZKB3167J	1	50	
ZKB20	1 1/4	25	

CALL: (800) 723-2826

## SHRINK TUBING DOUBLE WALL

Line: 1594-00



PART NUMBER	SIZE	QTY/BX	LIST PRICE
JED03192RED	W 22-18 X 6 CC RED	10	
JED04192BL	W 16-14 X 6CC BLUE	10	
JED06192Y	W12-10 X6CC YELLOW	10	
JED01192	1/16 X 6 THIN WALL BLACK	10	
JED02192	1/8 X 6 BLACK	10	
JED02192C	1/8 X 6 CLEAR	10	
JED02192R	1/8 X 6 RED	10	
JED03192BL	3/16 X 6 BLUE	10	
JED03192	3/16 X 6 BLACK	10	
JED03192C	3/16 X 6 CLEAR	10	
JED03192R	3/16 X 6 RED	10	
JED04192	1/4 X 6 BLACK	10	
JED04192C	1/4 X 6 CLEAR	10	
JED04192R	1/4 X 6 RED	10	
JED06192	3/8 X 6 BLACK	10	
JED06192BL	3/8 X 6 BLUE	10	
JED06192BSIL	3/8 X 6 W/SEALANT BLACK	10	
JED06192C	3/8 X 6 CLEAR	10	
JED06192R	3/8 X 6 RED	10	
JED06192RSIL	3/8 X 6 W/SEALANT RED	10	
JED08192	1/2 X 6 BLACK	10	
JED08192BSIL	1/2 X 6 W/SEALANT BLACK	10	
JED08192G	1/2 X 6 GREEN	10	
JED08192R	1/2 X 6 RED	10	
JED08192RSIL	1/2 X 6 W/SEALANT RED	10	
JED12192	3/4 X 6 BLACK	5	
JED12192BSIL	3/4 X 6 W/SEALANT BLACK	5	
JED12192G	3/4 X 6 GREEN	5	
JED12192R	3/4 X 6 RED	5	
JED12192RSIL	3/4 X 6 W/SEALANT RED	5	
JED16192G	1 X 6 GREEN	5	
JED16192	1 X 6 BLACK	5	
JED16192R	1 X 6 RED	5	
JED16192BSIL	1-1/8 X 6 W/SEALANT BLACK	5	
JED16192RSIL	1-1/8 X 6 W/SEALANT RED	5	
JED24192	1 1/2 X 6 BLACK	5	

## RUBBER O-RINGS

BUNA-N MATERIAL - 70 DUROMETER

Line: 1598-00



PART NUMBER	SIZE	QTY/BX	LIST PRICE
ZPB002X	3/64 X 9/64 X 3/64	25	
ZPB004	5/64 X 13/64 X 1/16	25	
ZPB005	3/32 X 7/32 X 1/16	25	
ZPB006	1/8 X 1/4 X 1/16	25	
ZPB007	5/32 X 9/32 X 1/16	25	
ZPB008	3/16 X 5/16 X 1/16	25	
ZPB009	7/32 X 11/32 X 1/16	25	
ZPB010	1/4 X 3/8 X 1/16	25	
ZPB011	5/16 X 7/16 X 1/16	25	
ZPB012	3/8 X 1/2 X 1/16	25	
ZPB013	7/16 X 9/16 X 1/16	25	
ZPB014	1/2 X 5/8 X 1/16	25	
ZPB015	9/16 X 11/16 X 1/16	25	
ZPB016	5/8 X 3/4 X 1/16	25	
ZPB017	11/16 X 13/16 X 1/16	25	
ZPB018	3/4 X 7/8 X 1/16	25	
ZPB019	13/16 X 15/16 X 1/16	25	
ZPB020	7/8 X 1 X 1/16	25	
ZPB021	15/16 X 1 1/16 X 1/16	25	
ZPB022	1 X 1 1/8 X 1/16	25	
ZPB023	1 1/16 X 1 3/16 X 1/16	25	
ZPB024X	1 1/8 X 1 1/4 X 1/16	25	
ZPB025	1 3/16 X 1 5/16 X 1/16	25	
ZPB026	1 1/4 X 1 3/8 X 1/16	25	
ZPB027	1 5/16 X 1 7/16 X 1/16	25	
ZPB028	1 3/8 X 1 1/2 X 1/16	25	
ZPB029	1 1/2 X 1 5/8 X 1/16	25	
ZPB030	1 5/8 X 1 3/4 X 1/16	25	
ZPB031	1 3/4 X 1 7/8 X 1/16	25	
ZPB032	1 7/8 X 2 X 1/16	25	
ZPB033	2 X 2 1/8 X 1/16	25	
ZPB034	2 1/8 X 2 1/4 X 1/16	25	
ZPB035X	2 1/4 X 2 3/8 X 1/16	25	
ZPB036	2 3/8 X 2 1/2 X 1/16	25	
ZPB037	2 1/2 X 2 5/8 X 1/16	25	
ZPB038	2 5/8 X 2 3/4 X 1/16	25	
ZPB039	2 3/4 X 2 7/8 X 1/16	25	
ZPB040	2 7/8 X 3 X 1/16	25	
ZPB041	3 X 3 1/8 X 1/16	25	

(continued...)

**RUBBER O-RINGS (cont.)**  
 BUNA-N MATERIAL-70 DUROMETER  
 Line: 1598-00



PART NUMBER	SIZE	QTY/BX	LIST PRICE
ZPB106	3/16 X 3/8 X 3/32	25	
ZPB108	1/4 X 7/16 X 3/32	25	
ZPB109	5/16 X 1/2 X 3/32	25	
ZPB110	3/8 X 9/16 X 3/32	25	
ZPB111	7/16 X 5/8 X 3/32	25	
ZPB112	1/2 X 11/16 X 3/32	25	
ZPB113	9/16 X 3/4 X 3/32	25	
ZPB114	5/8 X 13/16 X 3/32	25	
ZPB115	11/16 X 7/8 X 3/32	25	
ZPB116	3/4 X 15/16 X 3/32	25	
ZPB117	13/16 X 1 X 3/32	25	
ZPB118	7/8 X 1 1/16 X 3/32	25	
ZPB119	15/16 X 1 1/8 X 3/32	25	
ZPB120	1 X 1 3/16 X 3/32	25	
ZPB121	1 1/16 X 1 1/4 X 3/32	25	
ZPB122	1 1/8 X 1 5/16 X 3/32	25	
ZPB123	1 3/16 X 1 3/8 X 3/32	25	
ZPB124	1 1/4 X 1 7/16 X 3/32	25	
ZPB125	1 5/16 X 1 1/2 X 3/32	25	
ZPB126	1 3/8 X 1 9/16 X 3/32	25	
ZPB127	1 7/16 X 1 5/8 X 3/32	25	
ZPB128	1 1/2 X 1 11/16 X 3/32	25	
ZPB129	1 9/16 X 1 3/4 X 3/32	25	
ZPB130	1 5/8 X 1 13/16 X 3/32	25	
ZPB131	1 11/16 X 1 7/8 X 3/32	25	
ZPB132	1 3/4 X 1 15/16 X 3/32	25	
ZPB133	1 13/16 X 2 X 3/32	25	
ZPB134	1 7/8 X 2 1/16 X 3/32	25	
ZPB135	1 15/16 X 2 1/8 X 3/32	25	
ZPB136	2 X 2 3/16 X 3/32	25	
ZPB137	2 1/16 X 2 1/4 X 3/32	25	
ZPB138	2 1/8 X 2 5/16 X 3/32	25	
ZPB139	2 3/16 X 2 3/8 X 3/32	25	
ZPB140	2 1/4 X 2 7/16 X 3/32	25	
ZPB141	2 5/16 X 2 1/2 X 3/32	25	
ZPB142	2 3/8 X 2 9/16 X 3/32	25	
ZPB143	2 7/16 X 2 5/8 X 3/32	25	
ZPB144	2 1/2 X 2 11/16 X 3/32	25	
ZPB145	2 9/16 X 2 3/4 X 3/32	25	

(continued...)

**RUBBER O-RINGS (cont.)**  
 BUNA-N MATERIAL-70 DUROMETER  
 Line: 1598-00



PART NUMBER	SIZE	QTY/BX	LIST PRICE
ZPB146	2 5/8 X 2 13/16 X 3/32	25	
ZPB147	2 11/16 X 2 7/8 X 3/32	25	
ZPB148	2 3/4 X 2 15/16 X 3/32	25	
ZPB149	2 13/16 X 3 X 3/32	25	
ZPB150	2 7/8 X 3 1/16 X 3/32	25	
ZPB151	3 X 3 3/16 X 3/32	25	
ZPB152	3 1/4 X 3 7/16 X 3/32	25	
ZPB153	3 1/2 X 3 11/16 X 3/32	25	
ZPB154	3 3/4 X 3 15/16 X 3/32	25	
ZPB155	4 X 4 3/16 X 3/32	25	
ZPB156	4 1/4 X 3/32	25	
ZPB160	5 1/4 X 5 7/16 X 3/32	25	
ZPB157	4 1/2 X 4 11/16 X 3/32	25	
ZPB158	4 3/4 X 4 15/16 X 3/32	25	
ZPB159	5 X 5 3/16 X 3/32	25	
ZPB161	5 1/2 X 5 11/16 X 3/32	25	
ZPB162	5 3/4 X 5 15/16 X 3/32	25	
ZPB163	6 X 6 3/16 X 3/32	25	
ZPB201	3/16 X 7/16 X 1/8	25	
ZPB205	7/16 X 11/16 X 1/8	25	
ZPB206	1/2 X 3/4 X 1/8	25	
ZPB207	9/16 X 13/16 X 1/8	25	
ZPB208	5/8 X 7/8 X 1/8	25	
ZPB209	11/16 X 15/16 X 1/8	25	
ZPB210	3/4 X 1 X 1/8	25	
ZPB211	13/16 X 1 1/16 X 1/8	25	
ZPB212	7/8 X 1 1/8 X 1/8	25	
ZPB213	15/16 X 1 3/16 X 1/8	25	
ZPB214	1 X 1 1/4 X 1/8	25	
ZPB215	1 1/16 X 1 5/16 X 1/8	25	
ZPB216	1 1/8 X 1 3/8 X 1/8	25	
ZPB217	1 3/16 X 1 7/16 X 1/8	25	
ZPB218	1 1/4 X 1 1/2 X 1/8	25	
ZPB219	1 5/16 X 1 9/16 X 1/8	25	
ZPB220	1 3/8 X 1 5/8 X 1/8	25	
ZPB221	1 7/16 X 1 11/16 X 1/8	25	
ZPB222	1 1/2 X 1 3/4 X 1/8	25	
ZPB223	1 5/8 X 1 7/8 X 1/8	25	
ZPB224	1 3/4 X 2 X 1/8	25	
ZPB225	1 7/8 X 2 1/8 X 1/8	25	

(continued...)

**CALL: (800) 723-2826**

**RUBBER O-RINGS (cont.)**

BUNA-N MATERIAL-70 DUROMETER

Line: 1598-00



PART NUMBER	SIZE	QTY/BX	LIST PRICE
ZPB226	2 X 2 1/4 X 1/8	25	
ZPB227	2 1/8 X 2 3/8 X 1/8	25	
ZPB228	2 1/4 X 2 1/2 X 1/8	25	
ZPB229	2 3/8 X 2 5/8 X 1/8	25	
ZPB230	2 1/2 X 2 3/4 X 1/8	25	
ZPB231	2 5/8 X 2 7/8 X 1/8	25	
ZPB232	2 3/4 X 3 X 1/8	25	
ZPB233	2 7/8 X 3 1/8 X 1/8	25	
ZPB234	3 X 3 1/4 X 1/8	25	
ZPB235	3 1/8 X 3 3/8 X 1/8	25	
ZPB236	3 1/4 X 3 1/2 X 1/8	25	
ZPB237	3 3/8 X 3 5/8 X 1/8	25	
ZPB238	3 1/2 X 3 3/4 X 1/8	25	
ZPB239	3 5/8 X 3 7/8 X 1/8	25	
ZPB240	3 3/4 X 4 X 1/8	25	
ZPB241	3 7/8 X 4 1/8 X 1/8	25	
ZPB242	4 X 4 1/4 X 1/8	25	
ZPB243	4 1/8 X 4 3/8 X 1/8	25	
ZPB244	4 1/4 X 4 1/2 X 1/8	25	
ZPB245	4 3/8 X 4 5/8 X 1/8	25	
ZPB246	4 1/2 X 4 3/4 X 1/8	25	
ZPB247	4 5/8 X 4 7/8 X 1/8	25	
ZPB248	4 3/4 X 5 X 1/8	25	
ZPB249	4 7/8 X 5 1/8 X 1/8	25	
ZPB250	5 X 5 1/4 X 1/8	25	
ZPB251	5 1/8 X 5 3/8 X 1/8	25	
ZPB252	5 1/4 X 5 1/2 X 1/8	25	
ZPB253	5 3/8 X 5 5/8 X 1/8	25	
ZPB254	5 1/2 X 5 3/4 X 1/8	25	
ZPB255	5 5/8 X 5 7/8 X 1/8	25	
ZPB256	5 3/4 X 6 X 1/8	25	
ZPB257	5 7/8 X 1/8 X 1/8	25	
ZPB258X	6 X 6 1/4 X 1/8	25	
ZPB260	6 1/2 X 6 3/4 X 1/8	25	
ZPB267	8 1/4 X 8 1/2 X 1/8	25	
ZPB314X	3/4 X 1 1/8 X 3/16	25	
ZPB320X	1 1/8 X 1 1/2 X 3/16	25	
ZPB321	1 3/16 X 1 9/16 X 3/16	25	
ZPB322	1 1/4 X 1 5/8 X 3/16	25	
ZPB323	1 5/16 X 1 11/16 X 3/16	25	

(continued...)

**RUBBER O-RINGS (cont.)**

BUNA-N MATERIAL-70 DUROMETER

Line: 1598-00



PART NUMBER	SIZE	QTY/BX	LIST PRICE
ZPB324	1 3/8 X 1 3/4 X 3/16	25	
ZPB325	1 1/2 X 1 7/8 X 3/16	25	
ZPB326	1 5/8 X 2 X 3/16	25	
ZPB327	1 3/4 X 2 1/8 X 3/16	25	
ZPB328	1 7/8 X 2 1/4 X 3/16	25	
ZPB329	2 X 2 3/8 X 3/16	25	
ZPB330	2 1/8 X 2 1/2 X 3/16	25	
ZPB331	2 1/4 X 2 5/8 X 3/16	25	
ZPB332	2 3/8 X 2 3/4 X 3/16	25	
ZPB333	2 1/2 X 2 7/8 X 3/16	25	
ZPB334	2 5/8 X 3 X 3/16	25	
ZPB335	2 3/4 X 3 1/8 X 3/16	25	
ZPB336	2 7/8 X 3 1/4 X 3/16	25	
ZPB337	3 X 3 3/8 X 3/16	25	
ZPB338	3 1/8 X 3 1/2 X 3/16	25	
ZPB339	3 1/4 X 3 5/8 X 3/16	25	
ZPB340	3 3/8 X 3 3/4 X 3/16	25	
ZPB341	3 1/2 X 3 7/8 X 3/16	25	
ZPB342	3 5/8 X 4 X 3/16	25	
ZPB343	3 3/4 X 4 1/8 X 3/16	25	
ZPB344	3 7/8 X 4 1/4 X 3/16	25	
ZPB345	4 X 4 3/8 X 3/16	25	
ZPB346	4 1/8 X 3 1/2 X 3/16	25	
ZPB348	4 3/8 X 4 3/4 X 3/16	25	
ZPB349	4 1/2 X 4 7/8 X 3/16	25	
ZPB350	4 5/8 X 5 X 3/16	25	
ZPB351	4 3/4 X 5 1/8 X 3/16	25	
ZPB352	4 7/8 X 5 1/4 X 3/16	25	
ZPB353	5 X 5 3/8 X 3/16	25	
ZPB354	5 1/8 X 5 1/2 X 3/16	25	
ZPB355	5 1/4 X 5 5/8 X 3/16	25	
ZPB356	5 3/8 X 5 3/4 X 3/16	25	
ZPB357	5 1/2 X 5 7/8 X 3/16	25	
ZPB358	5 5/8 X 6 X 3/16	25	
ZPB359	5 3/4 X 6 1/8 X 3/16	25	
ZPB360	5 7/8 X 6 1/4 X 3/16	25	
ZPB361	6 X 6 3/8 X 3/16	25	
ZPB418X	3 5/8 X 4 1/8 X 1/4	25	
ZPB425	4 1/2 X 5 X 1/4	25	
ZPB426	4 5/8 X 5 1/8 X 1/4	25	

(continued...)

**RUBBER O-RINGS (cont.)**

BUNA-N MATERIAL-70 DUROMETER

Line: 1598-00



PART NUMBER	SIZE	QTY/BX	LIST PRICE
ZPB427	4 3/4 X 5 1/4 X 1/4	25	
ZPB428	4 7/8 X 5 3/8 X 1/4	25	
ZPB429	5 X 5 1/2 X 1/4	25	
ZPB430	5 1/8 X 5 5/8 X 1/4	25	
ZPB431	5 1/4 X 5 3/4 X 1/4	25	
ZPB432	5 3/8 X 5 7/8 X 1/4	25	
ZPB433	5 1/2 X 6 X 1/4	25	
ZPB434	5 5/8 X 6 1/8 X 1/4	25	
ZPB435	5 3/4 X 6 1/4 X 1/4	25	
ZPB436	5 7/8 X 6 3/8 X 1/4	25	
ZPB347	4.22 X 4.64 X .210CS	25	

**RUBBER O-RINGS**

VITON MATERIAL - 75 DUROMETER

Line: 1598-01



PART NUMBER	SIZE	QTY/BX	LIST PRICE
JVF003BR	1/16 X 3/16 X 1/16	25	
JVF004BR	5/64 X 13/64 X 1/16	25	
JVF005BR	3/32 X 7/32 X 1/16	25	
JVF006	1/8 X 1/4 X 1/16	25	
JVF006BR	1/8 X 1/4 X 1/16	25	
JVF007	5/32 X 9/32 X 1/16	25	
JVF007BR	5/32 X 9/32 X 1/16	25	
JVF008	3/16 X 5/16 X 1/16	25	
JVF008BR	3/16 X 5/16 X 1/16	25	
JVF009	7/32 X 11/32 X 1/16	25	
JVF009BR	7/32 X 11/32 X 1/16	25	
JVF010BR	1/4 X 3/8 X 1/16	25	
JVF010X	1/4 X 3/8 X 1/16	25	
JVF011	5/16 X 7/16 X 1/16	25	
JVF011BR	5/16 X 7/16 X 1/16	25	
JVF012BR	3/8 X 1/2 X 1/16	25	
JVF012X	3/8 X 1/2 X 1/16	25	
JVF013	7/16 X 9/16 X 1/16	25	
JVF013BR	7/16 X 9/16 X 1/16	25	
JVF014	1/2 X 5/8 X 1/16	25	
JVF014BR	1/2 X 5/8 X 1/16	25	
JVF015	9/16 X 11/16 X 1/16	25	
JVF016	5/8 X 3/4 X 1/16	25	
JVF017BR	11/16 X 13/16 X 1/16	25	
JVF018BR	3/4 X 7/8 X 1/16	25	
JVF019BR	13/16 X 15/16 X 1/16	25	
JVF019X	13/16 X 15/16 X 1/16	25	
JVF022BR	1 X 1 1/8 X 1/16	25	
JVF023BR	1 1/16 X 1 3/16 X 1/16	25	
JVF026BR	1 1/4 X 1 3/8 X 1/16	25	
JVF028BR	1 3/8 X 1 1/2 X 1/16	25	
JVF032	1 7/8 X 2 X 1/16	25	
JVF032BR	1 7/8 X 2 X 1/16	25	
JVF033	2 X 2 1/8 X 1/16	25	
JVF034	2 1/8 X 2 1/4 X 1/16	25	
JVF035	2 1/4 X 2 3/8 X 1/16	25	
JVF035BR	2 1/4 X 2 3/8 X 1/16	25	
JVF036BR	2 3/8 X 2 1/2 X 1/16	25	
JVF037BR	2 1/2 X 2 5/8 X 1/16	25	

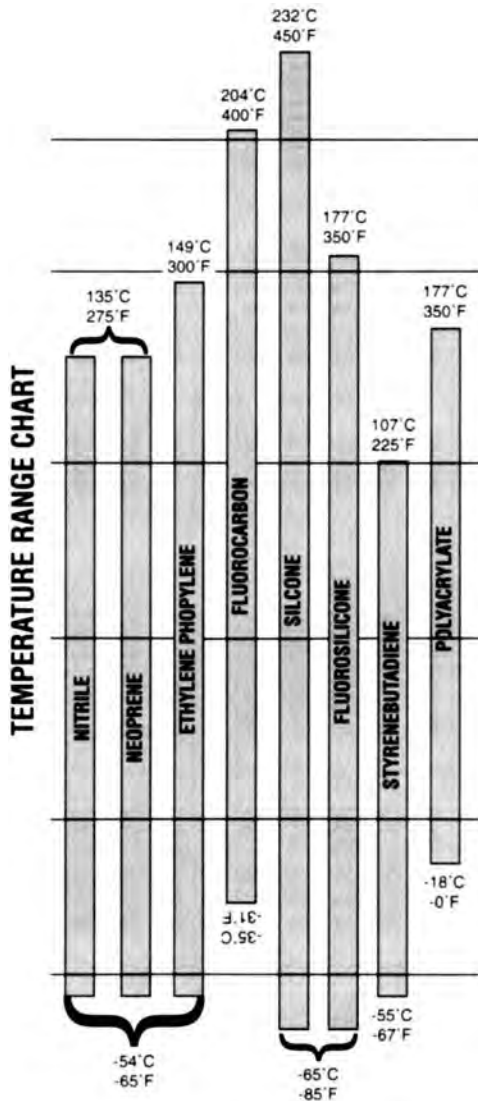

(continued...)

**RUBBER O-RINGS (cont.)**

VITON MATERIAL - 75 DUROMETER

Line: 1598-01



PART NUMBER	SIZE	QTY/BX	LIST PRICE
JVF039BR	2 3/4 X 2 7/8 X 1/16	25	
JVF040BR	2 7/8 X 3 X 1/16	25	
JVF042BR	3 1/4 X 3 3/8 X 1/16	25	
JVF044BR	3 3/4 X 3 7/8 X 1/16	25	
JVF047BR	4 1/2 X 4 5/8 X 1/16	25	
JVF048BR	4 3/4 X 4 7/8 X 1/16	25	
JVF102BR	1/16 X 1/4 X 3/32	25	
JVF103BR	3/32 X 9/32 X 3/32	25	
JVF104BR	1/8 X 5/16 X 3/32	25	
JVF105BR	5/32 X 11/32 X 3/32	25	
JVF106BR	3/16 X 3/8 X 3/32	25	
JVF107BR	7/32 X 13/32 X 3/32	25	
JVF108BR	1/4 X 7/16 X 3/32	25	
JVF109BR	5/16 X 1/2 X 3/32	25	
JVF110	3/8 X 9/16 X 3/32	25	
JVF111BR	7/16 X 5/8 X 3/32	25	
JVF111X	7/16 X 5/8 X 3/32	25	
JVF112BR	1/2 X 11/16 X 3/32	25	
JVF112X	1/2 X 11/16 X 3/32	25	
JVF113BR	9/16 X 3/4 X 3/32	25	
JVF113X	9/16 X 3/4 X 3/32	25	
JVF114BR	5/8 X 13/16 X 3/32	25	
JVF114X	5/8 X 13/16 X 3/32	25	
JVF115	11/16 X 7/8 X 3/32	25	
JVF115BR	11/16 X 7/8 X 3/32	25	
JVF116BR	3/4 X 15/16 X 3/32	25	
JVF116X	3/4 X 15/16 X 3/32	25	
JVF117BR	13/16 X 1 X 3/32	25	
JVF119BR	15/16 X 1 1/8 X 3/32	25	
JVF120BR	1 X 1 3/16 X 3/32	25	
JVF121BR	1 1/16 X 1 1/4 X 3/32	25	
JVF122BR	1 1/8 X 1 5/16 X 3/32	25	
JVF124BR	1 1/4 X 1 7/16 X 3/32	25	
JVF125BR	1 5/16 X 1 1/2 X 3/32	25	
JVF126BR	1 3/8 X 1 9/16 X 3/32	25	
JVF127BR	1 7/16 X 1 5/8 X 3/32	25	
JVF128BR	1 1/2 X 1 11/16 X 3/32	25	
JVF129BR	1 9/16 X 1 3/4 X 3/32	25	
JVF130BR	1 5/8 X 1 13/16 X 3/32	25	

(continued...)

**RUBBER O-RINGS (cont.)**

VITON MATERIAL - 75 DUROMETER

Line: 1598-01



PART NUMBER	SIZE	QTY/BX	LIST PRICE
JVF131	1 11/16 X 1 7/8 X 3/32	25	
JVF131BR	1 11/16 X 1 7/8 X 3/32	25	
JVF136BR	2 X 2 3/16 X 3/32	25	
JVF137BR	2 1/16 X 2 1/4 X 3/32	25	
JVF138BR	2 1/8 X 2 5/16 X 3/32	25	
JVF139BR	2 3/16 X 2 5/8 X 3/32	25	
JVF140BR	2 1/4 X 2 7/16 X 3/32	25	
JVF141BR	2 5/16 X 2 1/2 X 3/32	25	
JVF142BR	2 3/8 X 2 9/16 X 3/32	25	
JVF143	2 7/16 X 2 5/8 X 3/32	25	
JVF144BR	2 1/2 X 2 11/16 X 3/32	25	
JVF145BR	2 9/16 X 2 3/4 X 3/32	25	
JVF149BR	2 13/16 X 3 X 3/32	25	
JVF150BR	2 7/8 X 3 1/16 X 3/32	25	
JVF151BR	3 X 3 3/16 X 3/32	25	
JVF152BR	3 1/4 X 3 7/16 X 3/32	25	
JVF153BR	3 1/2 X 3 11/16 X 3/32	25	
JVF201BR	3/16 X 7/16 X 1/8	25	
JVF205	7/16 X 11/16 X 1/8	25	
JVF205BR	7/16 X 11/16 X 1/8	25	
JVF209BR	11/16 X 15/16 X 1/8	25	
JVF210X	3/4 X 1 X 1/8	25	
JVF211X	13/16 X 1 1/16 X 1/8	25	
JVF212	7/8 X 1 1/8 X 1/8	25	
JVF212BR	7/8 X 1 1/8 X 1/8	25	
JVF213	15/16 X 1 3/16 X 1/8	25	
JVF214	1 X 1 1/4 X 1/8	25	
JVF214BR	1 X 1 1/4 X 1/8	25	
JVF215	1 1/16 X 1 5/16 X 1/8	25	
JVF215BR	1 1/16 X 1 5/16 X 1/8	25	
JVF216	1 1/8 X 1 3/8 X 1/8	25	
JVF216BR	1 1/8 X 1 3/8 X 1/8	25	
JVF217	1 3/16 X 1 7/16 X 1/8	25	
JVF217BR	1 3/16 X 1 7/16 X 1/8	25	
JVF218BR	1 1/4 X 1 1/2 X 1/8	25	
JVF218X	1 1/4 X 1 1/2 X 1/8	25	
JVF219X	1 5/16 X 1 9/16 X 1/8	25	
JVF220	1 3/8 X 1 5/8 X 1/8	25	
JVF220BR	1 3/8 X 1 5/8 X 1/8	25	

(continued...)



**RUBBER O-RINGS (cont.)**

VITON MATERIAL - 75 DUROMETER

Line: 1598-01



PART NUMBER	SIZE	QTY/BX	LIST PRICE
JVF221BR	1 7/16 X 1 11/16 X 1/8	25	
JVF222	1 1/2 X 1 3/4 X 1/8	25	
JVF222BR	1 1/2 X 1 3/4 X 1/8	25	
JVF223	1 5/8 X 1 7/8 X 1/8	25	
JVF223BR	1 5/8 X 1 7/8 X 1/8	25	
JVF224	1 3/4 X 2 X 1/8	25	
JVF224BR	1 3/4 X 2 X 1/8	25	
JVF225BR	1 7/8 X 2 1/8 X 1/8	25	
JVF225X	1 7/8 X 2 1/8 X 1/8	25	
JVF228	2 1/4 X 2 1/2 X 1/8	25	
JVF228BR	2 1/4 X 2 1/2 X 1/8	25	
JVF233	2 7/8 X 3 1/8 X 1/8	25	
JVF234	3 X 3 1/4 X 1/8	25	
JVF236X	3 1/4 X 3 1/2 X 1/8	25	
JVF237BR	3 3/8 X 3 5/8 X 1/8	10	
JVF242BR	4 X 4 1/4 X 1/8	10	
JVF250BR	5 X 5 1/4 X 1/8	10	
JVF252BR	5 1/4 X 5 1/2 X 1/8	10	
JVF253BR	5 3/8 X 5 5/8 X 1/8	10	
JVF254BR	5 1/2 X 5 3/4 X 1/8	10	
JVF255BR	5 5/8 X 5 7/8 X 1/8	10	
JVF256BR	5 3/4 X 6 X 1/8	10	
JVF312BR	5/8 X 1 X 3/16	25	
JVF313BR	1 1/16 X 1 1/16 X 3/16	25	
JVF324BR	1 3/8 X 1 3/4 X 3/16	25	
JVF325	1 1/2 X 1 7/8 X 3/16	25	
JVF326BR	1 5/8 X 2 X 3/16	25	
JVF327X	1 3/4 X 2 1/8 X 3/16	25	
JVF329BR	2 X 2 3/8 X 3/16	10	
JVF330BR	2 1/8 X 2 1/2 X 3/16	10	
JVF337BR	3 X 3 3/8 X 3/16	10	
JVF351BR	4 3/4 X 5 1/8 X 3/16	10	
JVF357BR	5 1/2 X 5 7/8 X 3/16	10	

**METRIC O-RINGS**

BUNA-N MATERIAL - 70 DUROMETER

Line: 1598-02



PART NUMBER	SIZE	QTY/BX	LIST PRICE
ZPB1014N	M4 X 1.5 C/S	25	
ZPB1024N	M5 X 1.5 C/S	25	
ZPB1031N	M6 X 1.5 C/S	25	
ZPB1037N	M7 X 1.5 C/S	25	
ZPB1046N	M8 X 1.5 C/S	25	
ZPB1058N	M9 X 1.5 C/S	25	
ZPB1067N	M10 X 1.5 C/S	25	
ZPB1078N	M11 X 1.5 C/S	25	
ZPB1086N	M12 X 1.5 C/S	25	
ZPB1098N	M13 X 1.5 C/S	25	
ZPB1106N	M14 X 1.5 C/S	25	
ZPB1113N	M15 X 1.5 C/S	25	
ZPB1120N	M16 X 1.5 C/S	25	
ZPB1006N	M3 X 2.0 C/S	25	
ZPB1015N	M4 X 2.0 C/S	25	
ZPB1025N	M5 X 2.0 C/S	25	
ZPB1032N	M6 X 2.0 C/S	25	
ZPB1038N	M7 X 2.0 C/S	25	
ZPB1048N	M8 X 2.0 C/S	25	
ZPB1059N	M9 X 2.0 C/S	25	
ZPB1068N	M10 X 2.0 C/S	25	
ZPB1079N	M11 X 2.0 C/S	25	
ZPB1087N	M12 X 2.0 C/S	25	
ZPB1099N	M13 X 2.0 C/S	25	
ZPB1107N	M14 X 2.0 C/S	25	
ZPB1114N	M15 X 2.0 C/S	25	
ZPB1121N	M16 X 2.0 C/S	25	
ZPB1128N	M17 X 2.0 C/S	25	
ZPB1135N	M18 X 2.0 C/S	25	
ZPB1144N	M19 X 2.0 C/S	25	
ZPB1152N	M20 X 2.0 C/S	25	
ZPB1165N	M22 X 2.0 C/S	25	
ZPB1441N	M32 X 2.0 C/S	25	
ZPB1039N	M7 X 2.5 C/S	25	
ZPB1049N	M8 X 2.5 C/S	25	
ZPB1060N	M9 X 2.5 C/S	25	
ZPB1069N	M10 X 2.5 C/S	25	
ZPB1080N	M11 X 2.5 C/S	25	
ZPB1088N	M12 X 2.5 C/S	25	

(continued...)



**CALL - 1 (800) 723-2826**

**CALL: (800) 723-2826**

**METRIC O-RINGS (cont.)**

BUNA-N MATERIAL - 70 DUROMETER

Line: 1598-02



PART NUMBER	SIZE	QTY/BX	LIST PRICE
ZPB1100N	M13 X 2.5 C/S	25	
ZPB1108N	M14 X 2.5 C/S	25	
ZPB1115N	M15 X 2.5 C/S	25	
ZPB1122N	M16 X 2.5 C/S	25	
ZPB1129N	M17 X 2.5 C/S	25	
ZPB1136N	M18 X 2.5 C/S	25	
ZPB1145N	M19 X 2.5 C/S	25	
ZPB1153N	M20 X 2.5 C/S	25	
ZPB1425N	M29 X 2.5 C/S	25	
ZPB3474N	M33 X 2.5 C/S	25	
ZPB1070N	M10 X 3.0 C/S	25	
ZPB1081N	M11 X 3.0 C/S	25	
ZPB1116N	M15 X 3.0 C/S	25	
ZPB1359N	M17 X 3.0 C/S	25	
ZPB1154N	M20 X 3.0 C/S	25	
ZPB1171N	M23 X 3.0 C/S	25	
ZPB1260N	M25 X 3.0 C/S	25	
ZPB1184N	M27 X 3.0 C/S	25	
ZPB1187N	M28 X 3.0 C/S	25	
ZPB2435N	M29 X 3.0 C/S	25	
ZPB1190N	M30 X 3.0 C/S	25	
ZPB1438N	M31 X 3.0 C/S	25	
ZPB1443N	M32 X 3.0 C/S	25	
ZPB1450N	M33 X 3.0 C/S	25	
ZPB1261N	M35 X 3.0 C/S	25	
ZPB1466N	M36 X 3.0 C/S	25	
ZPB1475N	M37 X 3.0 C/S	25	
ZPB1262N	M38 X 3.0 C/S	25	
ZPB1215N	M39 X 3.0 C/S	25	
ZPB3465N	M41 X 3.0 C/S	25	
ZPB1504N	M42 X 3.0 C/S	25	
ZPB1510N	M43 X 3.0 C/S	25	
ZPB1519N	M45 X 3.0 C/S	25	
ZPB1524N	M46 X 3.0 C/S	25	
ZPB1264N	M47 X 3.0 C/S	25	
ZPB0202N	M6 X 3.5 C/S	25	
ZPB1365N	M19 X 3.5 C/S	25	
ZPB1172N	M23 X 3.5 C/S	25	
ZPB3475N	M33 X 3.5 C/S	25	

(continued...)

**METRIC O-RINGS (cont.)**

BUNA-N MATERIAL - 70 DUROMETER

Line: 1598-02



PART NUMBER	SIZE	QTY/BX	LIST PRICE
ZPB1484N	M38 X 3.5 C/S	25	
ZPB1398N	M25 X 4.0 C/S	25	
ZPB1404N	M26 X 4.0 C/S	25	
ZPB1420N	M28 X 4.0 C/S	25	
ZPB1434N	M30 X 4.0 C/S	25	
ZPB1263N	M38 X 4.0 C/S	25	
ZPB1498N	M41 X 4.0 C/S	25	
ZPB1993N	M44 X 4.0 C/S	25	

**JACK NUT THREADED INSERT**

STEEL PLATED

Line: 1612-10



PART NUMBER	SIZE	QTY/BX	LIST PRICE
BLWJNT2200	JACK NUT HAND TOOL	1	
BLWPR632	6/32 NT2200 PULL ROD	1	
BLW45JN	6/32 (1/64-3/16) GRIP	25	
BLW4LJN	6/32 (3/16-3/8) GRIP	25	
BLWPR1024	10/24 NT2200 PULLROD	1	
BLW65JN	10/24 (1/64-3/16) GRIP	25	
BLW6LJN	10/24 (3/16-3/8) GRIP	25	
BLWPR1420	1/4-20 NT2200 PULLROD	1	
BLW85JN	1/4-20 (1/64-3/16) GRIP	25	
BLW8LJN	1/4-20 (3/16-3/8) GRIP	25	

**WELL NUT THREADED INSERT**

NEOPRENE BRASS INSERT

Line: 1612-11



PART NUMBER	SIZE	QTY/BX	LIST PRICE
BLX19919A	M5-.8 (.034-.233) GRIP	25	
BLXE632	6/32 (1/64-5/32) GRIP	25	
BLXC632	6/32 (3/8-19/32) GRIP	25	
BLXB832	8/32 (1/64-5/32) GRIP	25	
BLX1024L	10/24 (.030-.227)	100	
BLXJ1032	10/32 (.03-227) .75HD	25	
BLXQ1032	10/32 (1/32-15/64) GRIP	25	
BLX105	10/32 (1/64-3/16) GRIP	25	
BLX105L	10/32 (5/16-5/8) GRIP	25	
BLX145	1/4-20 (1/64-7/64) GRIP	25	
BLX1420	1/4-20 (1/32-3/16) GRIP	25	
BLXJ1420	1/4-20 (1/4-7/16) GRIP	25	
BLXE51618	5/16-18 (1/64-5/32) GRIP	15	
BLXA3816	3/8-16 (1/64-7/16) GRIP	15	

**COLORED SCREW COVERS AND BASES**

NYLON  
Line: 1616-01



PART NUMBER	SIZE	QTY/BX	LIST PRICE
AYE810BAN	#8-10 BANANA 66	100	
AYE810BEG	#8-10 BEIGE 03	100	
AYE810BGN	#8-10 BRIGHT GREEN 52	100	
AYE810BLK	#8-10 BLACK 02	100	
AYE810BLU	#8-10 BLUE 18	100	
AYE810BRD	#8-10 BURNT RED 40	100	
AYE810BRN	#8-10 BROWN 17	100	
AYE810BUT	#8-10 BUTTERSCOTCH 56	100	
AYE810CHG	#8-10 CHARCOAL GRAY 63	100	
AYE810CHOC	#8-10 CHOCOLATE #31	100	
AYE810CRM	#8-10 CREAM 32	100	
AYE810CTBS	#8-10 CTSK BASE	100	
AYE810DBL	#8-10 DARK BLUE 34	100	
AYE810DRS	#8-10 DUSTY ROSE 57	100	
AYE810GRN	#8-10 GREEN 13	100	
AYE810GRY	#8-10 GREY #21	100	
AYE810PBL	#8-10 POWDER BLUE 39	100	
AYE810PHC	#8-10 PAN HINGED GRAY	100	
AYE810PHCBN	#8-10 PAN HINGD BONE	100	
AYE810PHCCRM	#8-10 PAN HINGED CREAM	100	
AYE810PHCWH	#8-10 PAN HINGED WHITE	100	
AYE810RED	#8-10 RED 04	100	
AYE810SGL	#8-10 SATIN GOLD 101	100	
AYE810SKB	#8-10 SKY BLUE 58	100	
AYE810SSL	#8-10 SATIN SILVER104	100	
AYE810WH	#8-10 WHITE 01	100	
AYE810YEL	#8-10 YELLOW 20	100	
AYE08PBS	#8 PAN HEAD BASE	100	
AYE10PBS	#10 PAN HEAD BASE	100	
AYE1420PBS	1/4 PAN HEAD BASE	100	
AYE1420WH	1/4 WHITE 01	100	
AYE1420CTBS	1/4-20 CTSK BASE	100	
AYE1420GRY	1/4-20 GREY #21	100	
AYE1HXDC08001	11/32AF WHITE DOME CAP	1000	
AYE1HDC01001	3/8AF WHITE DOME CAP	1000	
AYE1HDC250001	7/16AF WHITE DOME CAP	1000	
AYE1HDC312001	1/2AF WHITE DOME CAP	1000	

**SNAP STUD/SNAP CAP**

SNAP/SOC/TURN/FAST  
Line: 1616-16



PART NUMBER	SIZE	QTY/BX	LIST PRICE
CCLVL10127NB	CAPS NICKEL/BRASS 5/16 BRL	500	
CCLVL10128BLK	CAPS BLACK/BRASS	500	
CCLVL10128NB	CAPS NICKEL/BRASS 1/4 BRL	500	
CCLVL10224	SNAP SOCKETS NICKEL/BRASS	100	
CCL12104PD	12/12#104 TEAK SNCAP	100	
CCLVL1039312	#8X3/8 SCREW STUD NB	100	
CCLVL1039320	#8X5/8 SCREW STUD NB	100	

**MUFFLER CLAMPS**

Line: 1618-00



PART NUMBER	SIZE	QTY/BX	LIST PRICE
FHD3523A	1 1/8	1	
FHD3525A	1 1/4	1	
FHD3527A	1 1/2	1	
FHD3528A	1 5/8	1	
FHD3529A	1 3/4	1	
FHD3530A	1 7/8	1	
FHD3531A	2	1	
FHD3532A	2 1/4	1	
FHD3533A	2 1/2	1	
FHD3534A	2 3/4	1	
FHD3535A	3	1	
FHD3536A	3 1/4 HEAVY DUTY	1	
FHD3537A	3 1/2 HEAVY DUTY	1	
FHD3538A	4 HEAVY DUTY	1	
FHD3540A	4 1/2 HEAVY DUTY	1	
FHD3539A	5 HEAVY DUTY	1	

**E-Z LOCK THREAD INSERTS**

STEEL

Line: 1621-00



PART NUMBER	SIZE	QTY/BX	LIST PRICE
BJC329-006	6/32 X 1/4-20	10	
BJC329-008	8/32 X 5/16-18	10	
BJC329-3	10/24 X 3/8-16	10	
BJC329-332	10/32 X 3/8-16	10	
BJC303-4	1/4-20 X 7/16-14 STAINLESS STEEL	5	
BJC329-4	1/4-20 X 7/16-14	10	
BJC329-428	1/4-28 X 7/16-14	10	
BJC303-5	5/16-18 X 1/2-13 STAINLESS STEEL	5	
BJC329-5	5/16-18 X 1/2-13	10	

(continued...)

**CALL: (800) 723-2826**

## E-Z LOCK THREAD INSERTS (cont.)

STEEL

Line: 1621-00



PART NUMBER	SIZE	QTY/BX	LIST PRICE
<b>BJC329-524</b>	5/16-24 X 1/2-13	10	
<b>BJC329-6</b>	3/8-16 X 9/16-12	10	
<b>BJC329-624</b>	3/8-24 X 9/16-12	10	
<b>BJC329-7</b>	7/16-14 X 5/8-11	5	
<b>BJC329-720</b>	7/16-20 X 5/8-11	5	
<b>BJC329-8</b>	1/2-13 X 3/4-10	5	
<b>BJC329-820</b>	1/2-20 X 3/4-10	5	
<b>BJC329-9</b>	9/16-12 X 3/4-10	5	
<b>BJC329-918</b>	9/16-18 X 3/4-10	5	
<b>BJC329-10</b>	5/8-11 X 7/8-9	5	
<b>BJC329-1018</b>	5/8-11 X 7/8-9 X 1.125	5	
<b>BJC335-10</b>	5/8-11 X 1-8 HVY	5	
<b>BJC329-10F</b>	5/8-18 X 7/8-9	5	
<b>BJC329-12</b>	3/4-10 X 1-8	5	
<b>BJC329-1216</b>	3/4-16 X 1-8	5	
<b>BJC329-14</b>	7/8-9 X 1 1/4-7	5	
<b>BJC329-1414</b>	7/8-14 X 1 1/4-7	5	
<b>BJC329-16</b>	1-8 X 1 3/8-12	1	
<b>BJC329-1614</b>	1-14 X 1 3/8-12	5	

## E-Z LOCK METRIC THREAD INSERTS

STEEL

Line: 1622-00



PART NUMBER	SIZE	QTY/BX	LIST PRICE
<b>BKC450-3</b>	M3-0.5 X M6-1.0	10	
<b>BKC450-4</b>	M4-0.7 X M8-1.25	10	
<b>BKC450-5</b>	M5-0.8 X M8-1.25	10	
<b>BKC450-6</b>	M6-1.0 X M10-1.5	10	
<b>BKC650-6</b>	M6-1.0 X 3/8-16	10	
<b>BKC450-8</b>	M8-1.25 X M12-1.75	5	
<b>BKC650-8</b>	M8-1.25 X 1/2-13	10	
<b>BKCS650-10</b>	M10-1.25 X 9/16-12	10	
<b>BKC450-10</b>	M10-1.5 X M16-2.0	5	
<b>BKC650-10</b>	M10-1.50 X 9/16-12	10	
<b>BKC450-12</b>	M12-1.75 X M16-2.0	5	
<b>BKC650-12</b>	M12-1.75 X 3/4-10	5	
<b>BKC650-14</b>	M14-2.0 X 7/8-9	5	
<b>BKC450-16</b>	M16-2.0 X M24.3.0	5	
<b>BKC650-16</b>	M16-2.0 X 1-8	5	

## E-Z LOCK WOOD/PLASTIC INSERTS

BRASS

Line: 1622-01



PART NUMBER	SIZE	QTY/BX	LIST PRICE
<b>BJK400004</b>	4/40 KNIFE THD	50	
<b>BJK400006</b>	6/32 KNIFE THD	50	
<b>BJK270006</b>	6/32 2 FIN EXP	50	
<b>BJK400008</b>	8/32 KNIFE THD	50	
<b>BJK270008</b>	8/32 2 FIN EXP	50	
<b>BJK4003</b>	10/24 KNIFE THD	50	
<b>BJK2703</b>	10/24 2 FIN EXP	50	
<b>BJK270332</b>	10/32 2 FIN EXP	50	
<b>BJK400332</b>	10/32 KNIFE THD	50	
<b>BJK2704</b>	1/4-20 2 FIN EXP	50	
<b>BJK4004</b>	1/4-20 KNIFE THD	50	
<b>BJK3705</b>	5/16-18 3 FIN EXP	50	
<b>BJK4005</b>	5/16-18 KNIFE THD	50	
<b>BJK4006</b>	3/8-16 KNIFE THD	50	

## KNIFE THREAD WOOD INSERTS

STEEL

Line: 1622-02



PART NUMBER	SIZE	QTY/BX	LIST PRICE
<b>BJKWI832S</b>	8/32	50	
<b>BJKWI1024S</b>	10/24 .472LG	50	
<b>BJKWI1032S</b>	10/32 HEX DRIVE .510 LG	50	
<b>BJKWI1420S</b>	1/4-20 .592LG	50	
<b>BJKWI3816S</b>	3/8-16 .984LG	50	
<b>BJKWI51618S</b>	5/16-18 .787LG	50	

## AUTOMOTIVE WHEEL BALANCE WEIGHTS

Line: 1622-95



PART NUMBER	SIZE	QTY/BX	LIST PRICE
CFB250AW	1/4 OZ TYPE AW	25	
CFB500AW	1/2 OZ TYPE AW	25	
CFB750AW	3/4 OZ TYPE AW	25	
CFB1000AW	1 OZ TYPE AW	25	
CFB1250AW	1 1/4 OZ TYPE AW	25	
CFB1500AW	1 1/2 OZ TYPE AW	25	
CFB1750AW	1 3/4 OZ TYPE AW	25	
CFB2000AW	2 OZ TYPE AW	25	
CFB2250AW	2 1/4 OZ TYPE AW	25	
CFB2500AW	2 1/2 OZ TYPE AW	50	
CFB2750AW	2 3/4 OZ TYPE AW	50	
CFB3000AW	3 OZ TYPE AW	50	
CFB250C	1/4 OZ TYPE C	25	
CFB500C	1/2 OZ TYPE C	25	
CFB750C	3/4 OZ TYPE C	25	
CFB1000C	1 OZ TYPE C	25	
CFB1250C	1 1/4 OZ TYPE C	25	
CFB1500C	1 1/2 OZ TYPE C	25	
CFB1750C	1 3/4 OZ TYPE C	25	
CFB2000C	2 OZ TYPE C	25	
CFB2250C	2 1/4 OZ TYPE C	25	
CFB2500C	2 1/2 OZ TYPE C	25	
CFB2750C	2 3/4 OZ TYPE C	50	
CFB3000C	3 OZ TYPE C	25	
CFB3250C	3 1/4 OZ TYPE C	25	
CFB3500C	3 1/2 OZ TYPE C	25	
CFB3750C	3 3/4 OZ TYPE C	25	
CFB4000C	4 OZ TYPE C	25	
CFB4500C	4 1/2 OZ TYPE C	25	
CFB5000C	5 OZ TYPE C	25	
CFB5500C	5 1/2 OZ TYPE C	25	
CFB6000C	6 OZ TYPE C	25	
CFB250CAW	1/4 OZ TYPE CAW-AWN	25	
CFB500CAW	1/2 OZ TYPE CAW-AWN	25	
CFB750CAW	3/4 OZ TYPE CAW-AWN	25	
CFB1000CAW	1 OZ TYPE CAW-AWN	25	
CFB1250CAW	1 1/4 OZ TYP CAW-AWN	25	
CFB1500CAW	1 1/2 OZ TYP CAW-AWN	25	
CFB1750CAW	1 3/4 OZ TYP CAW-AWN	25	
CFB2000CAW	2 OZ TYPE CAW-AWN	25	

(continued...)

## AUTOMOTIVE WHEEL BALANCE WEIGHTS (cont.)

Line: 1622-95



PART NUMBER	SIZE	QTY/BX	LIST PRICE
CFB2250CAW	2 1/4 OZ TYP CAW-AWN	25	
CFB2500CAW	2 1/2 OZ TYP CAW-AWN	25	
CFB2750CAW	2 3/4 OZ TYP CAW-AWN	25	
CFB3000CAW	3 OZ TYPE CAW-AWN	25	
CFB250CC	1/4 OZ TYPE CC	25	
CFB500CC	1/2 OZ TYPE CC	25	
CFB750CC	3/4 OZ TYPE CC	25	
CFB1000CC	1 OZ TYPE CC	25	
CFB1250CC	1 1/4 OZ TYPE CC	25	
CFB1500CC	1 1/2 OZ TYPE CC	25	
CFB1750CC	1 3/4 OZ TYPE CC	25	
CFB2000CC	2 OZ TYPE CC	25	
CFB2250CC	2 1/4 OZ TYPE CC	25	
CFB2500CC	2 1/2 OZ TYPE CC	25	
CFB2750CC	2 3/4 OZ TYPE CC	25	
CFB3000CC	3 OZ TYPE CC	25	
CFB5CFN	5 GRAM TYPE CFN	25	
CFB7.5CFN	7.5 GRAM TYPE CFN	25	
CFB10CFN	10 GRAM TYPE CFN	25	
CFB15CFN	15 GRAM TYPE CFN	25	
CFB25CFN	25 GRAM TYPE CFN	25	
CFB30CFN	30 GRAM TYPE CFN	25	
CFB20CFN	20 GRAM TYPE CFN	25	
CFB35CFN	35 GRAM TYPE CFN	25	
CFB40CFN	40 GRAM TYPE CFN	25	
CFB45CFN	45 GRAM TYPE CFN	25	
CFB50CFN	50 GRAM TYPE CFN	25	
CFB55CFN	55 GRAM TYPE CFN	25	
CFB60CFN	60 GRAM TYPE CFN	25	
CFB250CFR	1/4 OZ TYPE CFR-MCN	25	
CFB500CFR	1/2 OZ TYPE CFR-MCN	25	
CFB750CFR	3/4 OZ TYPE CFR-MCN	25	
CFB1000CFR	1 OZ TYPE CFR-MCN	25	
CFB1250CFR	1 1/4 OZ TYPE CFR-MCN	25	
CFB1500CFR	1 1/2 OZ TYPE CFR-MCN	25	
CFB1750CFR	1 3/4 OZ TYPE CFR-MCN	25	
CFB2000CFR	2 OZ TYPE CFR-MCN	25	
CFB2250CFR	2 1/4 OZ TYPE CFR-MCN	25	
CFB2500CFR	2 1/2 OZ TYPE CFR-MCN	25	

(continued...)

CALL: (800) 723-2826

## AUTOMOTIVE WHEEL BALANCE WEIGHTS (cont.)

Line: 1622-95



PART NUMBER	SIZE	QTY/BX	LIST PRICE
CFB2750CFR	2 3/4 OZ TYPE CFR-MCN	25	
CFB3000CFR	3 OZ TYPE CFR-MCN	25	
CFB250CIAW	1/4 OZ/10 GM CIAW	25	
CFB500CIAW	1/2 OZ/15 GM CIAW	25	
CFB750CIAW	3/4 OZ/20 GM CIAW	25	
CFB1000CIAW	1 OZ/30 GM CIAW	25	
CFB1250CIAW	1 1/4 OZ/35 GM	25	
CFB1500CIAW	1 1/2 OZ/40 GM CIAW	25	
CFB1750CIAW	1 3/4 OZ/50 GM CIAW	25	
CFB2000CIAW	2 OZ/55 GM CIAW	25	
CFB250CLH	1/4 OZ TYPE CLH	25	
CFB500CLH	1/2 OZ TYPE CLH	25	
CFB750CLH	3/4 OZ TYPE CLH	25	
CFB1000CLH	1 OZ TYPE CLH	25	
CFB1250CLH	1 1/4 OZ TYPE CLH	25	
CFB1500CLH	1 1/2 OZ TYPE CLH	25	
CFB1750CLH	1 3/4 OZ TYPE CLH	25	
CFB2000CLH	2 OZ TYPE CLH	25	
CFB2250CLH	2 1/4 OZ TYPE CLH	25	
CFB2500CLH	2 1/2 OZ TYPE CLH	25	
CFB3000CLH	3 OZ TYPE CLH	25	
CFB5FN	5 GRAM TYPE FN	25	
CFB10FN	10 GRAM TYPE FN	25	
CFB15FN	15 GRAM TYPE FN	25	
CFB20FN	20 GRAM TYPE FN	25	
CFB25FN	25 GRAM TYPE FN	25	
CFB30FN	30 GRAM TYPE FN FN	25	
CFB35FN	35 GRAM TYPE FN	25	
CFB40FN	40 GRAM TYPE FN FN	25	
CFB45FN	45 GRAM TYPE FN	25	
CFB50FN	50 GRAM TYPE FN FN	25	
CFB55FN	55 GRAM TYPE FN	25	
CFB60FN	60 GRAM TYPE FN	25	
CFB250IAW	1/4 OZ/10 GM IAW	25	
CFB500IAW	1/2 OZ/15 GM IAW	25	
CFB750IAW	3/4 OZ/20 GM IAW	25	
CFB1000IAW	1 OZ/30 GM IAW	25	
CFB1250IAW	1 1/4 OZ/35 GM IAW	25	
CFB1500IAW	1 1/2 OZ/40 GM IAW	25	
CFB1750IAW	1 3/4 OZ/50 GM IAW	25	

(continued...)

## AUTOMOTIVE WHEEL BALANCE WEIGHTS (cont.)

Line: 1622-95



PART NUMBER	SIZE	QTY/BX	LIST PRICE
CFB2000IAW	2 OZ/50 GM IAW	25	
CFB2250IAW	2 1/4 OZ TYPE IAW	25	
CFB250FR	1/4 OZ TYPE FR-MC	25	
CFB750FR	3/4 OZ TYPE FR-MC	25	
CFB1000FR	1 OZ TYPE FR-MC	25	
CFB1250FR	1 1/4 OZ TYPE FR-MC	25	
CFB1750FR	1 3/4 OZ TYPE FR-MC	25	
CFB2000FR	2 OZ TYPE FR-MC	25	
CFB100720	3 OZ 6AD ST 1/2 INC	60	
CFB250CNT	1/4 OZ COATED NT	25	
CFB500CNT	1/2 OZ COATED NT	25	
CFB750CNT	3/4 OZ COATED NT	25	
CFB1000CNT	1 OZ COATED NT	25	
CFB1250CNT	1 1/4 OZ COATED NT	25	
CFB1500CNT	1 1/2 OZ COATED NT	25	
CFB1750CNT	1 3/4 OZ COATED NT	25	

## SELECT WHEEL PARTS PRODUCTS

Line: 1622-99



PART NUMBER	SIZE	QTY/BX	LIST PRICE
DMC-M126	1 1/8-16 RH OUTER NUT	25	
DMC-M127	1 1/8-16 LH OUTER NUT	25	
DMC-M128	1 1/8-16 RH INNER NUT	25	
DMC-M129	1 1/8-16 LH INNER NUT	25	
DMC-M38	M-38 5/8 X 2 3/4 STUD	25	
DMC-M39	M-39 3/4 X 2 13/16 STUD	25	
DMC-M124	3/4-16 RH OUTER STUD	25	
DMC-M125X	3/4-16 LH OUTER STUD	25	

## RUBBER TARP STRAPS

Line: 1623-00



PART NUMBER	SIZE	QTY/BX	LIST PRICE
DMC-MSHK	S-HOOK ONLY	50	
DMC-M3066	9 (15-20 RANGE)	1	
DMC-M3067	15 (20-29 RANGE)	1	
DMC-M3068	20 (30-39 RANGE)	1	
DMC-M3069	31 (40-49 RANGE)	1	
DMC-M3065	41 (50-61 RANGE)	1	

# SECTION 18 PRODUCT INDEX

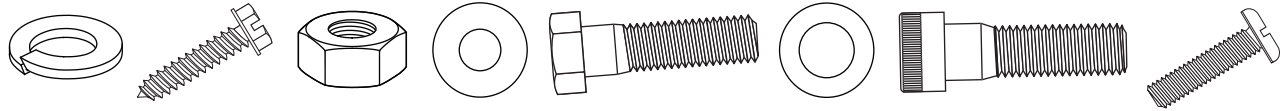

Line Description	Alpha	Line#	Page#
HEX CAP SCREWS DIN933 FULL THREAD 8.8 ZINC	JPN	1642-02	18-3
HEX CAP SCREWS DIN931 PARTIAL THREAD 8.8 ZINC	JRN	1642-03	18-6
HEX CAP SCREWS DIN960 PART FINE THREAD 8.8 ZINC	AAW	1642-06	18-8
HEX CAP SCREWS DIN961 FULL FINE THREAD 8.8 ZINC	AAX	1642-07	18-9
HEX CAP SCREWS DIN933 FULL THREAD 10.9 - YELLOW ZINC	AAP	1643-03	18-10
HEX CAP SCREWS DIN931 PART THREAD 10.9 - YELLOW ZINC	AAR	1643-04	18-10
METRIC FLANGE BOLTS DIN6921 10.9 - YELLOW ZINC	BMF	1643-20	18-12
METRIC FIN HEX NUT DIN934 CL 8 - ZINC	BNC	1644-00	18-13
METRIC FIN HEX NUT DIN934 CL 10 - PLAIN	ABH	1644-02	18-13
METRIC FIN HEX NUT DIN934 CL 10 - YELLOW ZINC	ATT	1644-03	18-14
METRIC MACH SCREW NUT DIN439B CL4 - ZINC	BPC	1645-00	18-14
METRIC FLEXLOC NUT FULL LITE HEX - CAD	CEN	1645-25	18-14
METRIC FLEXLOC NUT FULL LITE HEX - PLAIN	CEP	1645-26	18-14
METRIC NYLON INSERT LOCK NUT DIN985 CL10 - YELLOW ZINC	CBB	1645-99	18-15
METRIC NYLON INSERT LOCK NUT DIN985 CL8 - ZINC	BRC	1646-00	18-15
METRIC STEEL LOCK NUT DIN980V CL10 - PLATED	BSF	1646-01	18-15
METRIC NYLON INSERT LOCK NUT DIN985A2 ST/STL	AAV	1646-02	18-15
METRIC WING NUTS DIN315 - ZINC	BTV	1646-03	18-15
METRIC HEX JAM NUTS DIN439 - PLAIN	ABF	1646-05	18-16
METRIC ROD COUPLING NUTS DIN6334 - ZINC	CEL	1646-06	18-16
METRIC FLANGE NUT DIN 6923 CL10 NO/SERR - ZINC	CHG	1646-99	18-16
METRIC HEX JAM NUT DIN439B CL6 - ZINC	BSC	1647-00	18-16
METRIC FLANGE NUT DIN 6923 CL10 SERRATED - ZINC	BME	1647-01	18-16
METRIC HEAVY DUTY FLAT WASHERS DIN125B - ZINC	ABE	1647-04	18-17
METRIC FLAT WASHERS DIN125B 10.9 - HARDENED ZINC	ABK	1647-06	18-17
METRIC FLAT WASHERS DIN125B 10.9 - ZINC	BUC	1648-00	18-17
METRIC SPLIT LOCKWASHERS DIN127B - ZINC	BWC	1649-00	18-17
METRIC EXTERNAL TOOTH LOCKWASHERS DIN6797Z - PLATED	BXC	1650-00	18-18
METRIC INTERNAL TOOTH LOCKWASHERS DIN6797J - PLATED	BYC	1651-00	18-18
METRIC SPRING WAVE WASHER DIN137B - PLATED	BVC	1652-00	18-18
METRIC SOCKET HD CAP SCREW 12.9 DIN912 - BLACK	CDC	1653-00	18-18
METRIC FLAT SOCKET CAP SCREW 10.9 DIN7991 - BLACK	CFC	1654-00	18-21
METRIC SOCKET SET SCREW CUP PT DIN916 45H - BLACK	CCC	1655-00	18-23
METRIC BUTTON SOCKET CAP SCREW 10.9 ISO7380 - BLACK	BMJ	1656-00	18-24
METRIC LOW HD SOCKET CAP SCREW 8.8 DIN7984 - BLACK	CEC	1657-00	18-25
METRIC SOCKET HD SHOULDER SCREWS 12.9 ISO7379 - POLISHED	BMK	1657-01	18-26
METRIC HARDENED DOWEL PINS DIN6325 - LG	CFN	1657-02	18-26
METRIC THREADED ROD DIN975 4.6 GRADE - ZINC	BTC	1660-00	18-27
METRIC THREADED ROD DIN975 A2 - STAINLESS STEEL	BTN	1660-01	18-27
METRIC THREADED ROD DIN975 GRADE B7 - ALLOY PLAIN	BTP	1660-02	18-27

(CONTINUED...)

# SECTION 18 PRODUCT INDEX

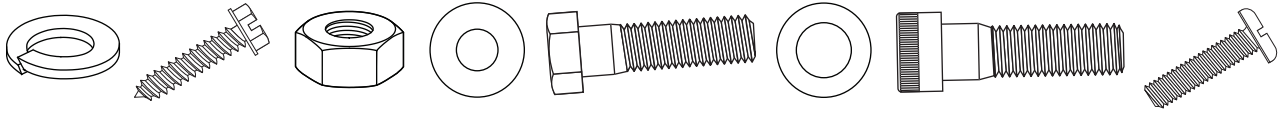

Line Description	Alpha	Line#	Page#
METRIC COTTER PINS DIN94 - ZINC PLATED	<b>BZC</b>	<b>1661-00</b>	<b>18-28</b>
METRIC SLTD CHEESE HD MACHINE SC DIN84 - ZINC	<b>CGC</b>	<b>1662-00</b>	<b>16-28</b>
METRIC SLTD FLAT HD MACHINE SC DIN963A - ZINC	<b>CHC</b>	<b>1662-01</b>	<b>16-30</b>
METRIC SLTD PAN HD MACHINE SC DIN85A - ZINC	<b>CJC</b>	<b>1663-00</b>	<b>18-31</b>
METRIC SLTD OVAL HD MACHINE SC DIN964 - ZINC	<b>CKC</b>	<b>1664-00</b>	<b>18-32</b>
METRIC PHILLIPS PAN HD MACHINE SC DIN7985 - ZINC	<b>CNC</b>	<b>1665-00</b>	<b>18-32</b>
METRIC PHILLIPS FLAT HD MACHINE SC DIN965A - ZINC	<b>CMC</b>	<b>1666-00</b>	<b>18-33</b>
METRIC PHILLIPS OVAL HD MACHINE SC DIN966 - ZINC	<b>CLC</b>	<b>1667-00</b>	<b>18-34</b>
METRIC HEX HD CAP SCREWS A2 - STAINLESS 933/931	<b>BSL</b>	<b>1670-00</b>	<b>18-35</b>
METRIC FLAT WASHERS DIN125A A2 - STAINLESS	<b>BSM</b>	<b>1670-04</b>	<b>18-37</b>
METRIC SPLIT LOCK WASHERS DIN127B A2 - STAINLESS	<b>BST</b>	<b>1670-06</b>	<b>18-37</b>
METRIC HEX NUTS DIN934 A2 - STAINLESS	<b>BSN</b>	<b>1670-08</b>	<b>18-37</b>
METRIC WING NUTS DIN315 - A-2 STAINLESS	<b>BSV</b>	<b>1670-09</b>	<b>18-37</b>
METRIC SLTD PAN MACHINE SCREW DIN85A - A2 - STAINLESS STEEL	<b>CBW</b>	<b>1670-11</b>	<b>18-37</b>
METRIC SLTD FLAT MACHINE SCREW DIN963A -A2 - STAINLESS STEEL	<b>CBX</b>	<b>1670-12</b>	<b>18-38</b>
METRIC PHILLIPS PAN MACHINE SCREW DIN7985-A2-STAINLESS STEEL	<b>BSP</b>	<b>1670-15</b>	<b>18-38</b>
METRIC PHILLIPS FLAT MACH. SCREW DIN965A-A2-STAINLESS STEEL	<b>BSR</b>	<b>1670-16</b>	<b>18-39</b>
METRIC PHILLIPS OVAL MACH. SCREW DIN966A-A2-STAINLESS STEEL	<b>BTX</b>	<b>1670-17</b>	<b>18-40</b>
METRIC SOCKET HD CAP SCREW DIN912 - A2 - STAINLESS STEEL	<b>BSW</b>	<b>1670-20</b>	<b>18-40</b>
METRIC SOCKET SET SCREW CUP PT DIN916 - A2 - STAINLESS STEEL	<b>BSX</b>	<b>1670-21</b>	<b>18-41</b>
METRIC FLAT SOCKET CAP SCREW DIN7991 - A2 - STAINLESS STEEL	<b>BTW</b>	<b>1670-22</b>	<b>18-43</b>
METRIC BUTTON SOCKET CAP SCREW ISO7380 - A2- STAINLESS STEEL	<b>BRL</b>	<b>1670-23</b>	<b>18-44</b>
METRIC LOW HD SOCKET CAP SCREW DIN7984 - A2 -STAINLESS STEEL	<b>BTY</b>	<b>1672-23</b>	<b>18-44</b>



**CALL - 1 (800) 723-2826**



# HEX CAP SCREW 8.8 DIN 933

FULLY THREADED - ZINC PLATED

Line: 1642-02

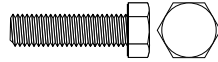

PART NUMBER	SIZE	QTY/BX	LIST PRICE
JPN03006	M3-.5 X 6	100	
JPN03008	M3-.5 X 8	100	
JPN03010	M3-.5 X 10	100	
JPN03012	M3-.5 X 12	100	
JPN03014X	M3-.5 X 14	100	
JPN03016	M3-.5 X 16	100	
JPN03018X	M3-.5 X 18	100	
JPN03020	M3-.5 X 20	100	
JPN03025	M3-.5 X 25	100	
JPN03030	M3-.5 X 30	100	
JPN04006	M4-.7 X 6	100	
JPN04008	M4-.7 X 8	100	
JPN04010	M4-.7 X 10	100	
JPN04012	M4-.7 X 12	100	
JPN04014X	M4-.7 X 14	100	
JPN04016	M4-.7 X 16	100	
JPN04018X	M4-.7 X 18	100	
JPN04020	M4-.7 X 20	100	
JPN04022X	M4-.7 X 22	100	
JPN04025	M4-.7 X 25	100	
JPN04030	M4-.7 X 30	100	
JPN04035	M4-.7 X 35	100	
JPN04040	M4-.7 X 40	100	
JPN05006	M5-.8 X 6	100	
JPN05008	M5-.8 X 8	100	
JPN05010	M5-.8 X 10	100	
JPN05012	M5-.8 X 12	100	
JPN05014X	M5-.8 X 14	100	
JPN05016	M5-.8 X 16	100	
JPN05018X	M5-.8 X 18	100	
JPN05020	M5-.8 X 20	100	
JPN05022X	M5-.8 X 22	100	
JPN05025	M5-.8 X 25	100	
JPN05030	M5-.8 X 30	100	
JPN05035	M5-.8 X 35	100	
JPN05040	M5-.8 X 40	100	
JPN05045	M5-.8 X 45	100	
JPN05050	M5-.8 X 50	100	
JPN06006	M6-1.0 X 6	100	
JPN06008	M6-1.0 X 8	100	

(continued...)

# HEX CAP SCREW 8.8 DIN 933 (cont.)

FULLY THREADED - ZINC PLATED

Line: 1642-02

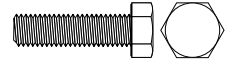

PART NUMBER	SIZE	QTY/BX	LIST PRICE
JPN06010	M6-1.0 X 10	100	
JPN06012	M6-1.0 X 12	100	
JPN06014X	M6-1.0 X 14	100	
JPN06016	M6-1.0 X 16	100	
JPN06018X	M6-1.0 X 18	100	
JPN06020	M6-1.0 X 20	100	
JPN06022X	M6-1.0 X 22	100	
JPN06025	M6-1.0 X 25	100	
JPN06028X	M6-1.0 X 28	100	
JPN06030	M6-1.0 X 30	100	
JPN06035	M6-1.0 X 35	100	
JPN06040	M6-1.0 X 40	100	
JPN06045	M6-1.0 X 45	100	
JPN06050	M6-1.0 X 50	100	
JPN06055	M6-1.0 X 55	100	
JPN06060	M6-1.0 X 60	100	
JPN06065	M6-1.0 X 65	50	
JPN06070	M6-1.0 X 70	50	
JPN06080	M6-1.0 X 80	50	
JPN06090	M6-1.0 X 90	50	
JPN06100	M6-1.0 X 100	50	
JPN07012	M7-1.0 X 12	100	
JPN07016	M7-1.0 X 16	100	
JPN07020	M7-1.0 X 20	100	
JPN07025	M7-1.0 X 25	100	
JPN07030	M7-1.0 X 30	100	
JPN07035	M7-1.0 X 35	100	
JPN07040	M7-1.0 X 40	100	
JPN07050	M7-1.0 X 50	100	
JPN08008	M8-1.25 X 8	100	
JPN08010	M8-1.25 X 10	100	
JPN08012	M8-1.25 X 12	100	
JPN08014X	M8-1.25 X 14	100	
JPN08016	M8-1.25 X 16	100	
JPN08018X	M8-1.25 X 18	100	
JPN08020	M8-1.25 X 20	100	
JPN08022X	M8-1.25 X 22	100	
JPN08025	M8-1.25 X 25	100	
JPN08028X	M8-1.25 X 28	100	
JPN08030	M8-1.25 X 30	100	

(continued...)

**HEX CAP SCREW 8.8 DIN 933 (cont.)**

FULLY THREADED - ZINC PLATED

Line: 1642-02

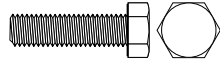

PART NUMBER	SIZE	QTY/BX	LIST PRICE
JPN08035	M8-1.25 X 35	100	
JPN08040	M8-1.25 X 40	100	
JPN08045	M8-1.25 X 45	100	
JPN08050	M8-1.25 X 50	50	
JPN08055	M8-1.25 X 55	50	
JPN08060	M8-1.25 X 60	50	
JPN08065	M8-1.25 X 65	50	
JPN08070	M8-1.25 X 70	50	
JPN08075	M8-1.25 X 75	50	
JPN08080	M8-1.25 X 80	50	
JPN08090	M8-1.25 X 90	50	
JPN08100	M8-1.25 X 100	50	
JPN10010	M10-1.5 X 10	100	
JPN10012	M10-1.5 X 12	100	
JPN10014X	M10-1.5 X 14	100	
JPN10016	M10-1.5 X 16	100	
JPN10016DIN	M10-1.5 X 16 DIN HEAD	100	
JPN10018X	M10-1.5 X 18	100	
JPN10020	M10-1.5 X 20	100	
JPN10020DIN	M10-1.5 X 20 DIN HEAD	100	
JPN10022X	M10-1.5 X 22	100	
JPN10025	M10-1.5 X 25	100	
JPN10030	M10-1.5 X 30	100	
JPN10030DIN	M10-1.5 X 30 DIN HEAD	100	
JPN10035	M10-1.5 X 35	100	
JPN10035DIN	M10-1.5 X 35 DIN HEAD	100	
JPN10040	M10-1.5 X 40	100	
JPN10045	M10-1.5 X 45	50	
JPN10045DIN	M10-1.5 X 45 DIN HEAD	50	
JPN10050	M10-1.5 X 50	100	
JPN10050DIN	M10-1.5 X 50 DIN HEAD	100	
JPN10055	M10-1.5 X 55	50	
JPN10055DIN	M10-1.5 X 55 DIN HEAD	50	
JPN10060	M10-1.5 X 60	50	
JPN10060DIN	M10-1.5 X 60 DIN HEAD	50	
JPN10065	M10-1.5 X 65	50	
JPN10070	M10-1.5 X 70	50	
JPN10070DIN	M10-1.5 X 70 DIN HEAD	50	
JPN10075	M10-1.5 X 75	25	
JPN10075DIN	M10-1.5 X 75 DIN HEAD	25	

(continued...)

**HEX CAP SCREW 8.8 DIN 933 (cont.)**

FULLY THREADED - ZINC PLATED

Line: 1642-02

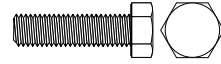

PART NUMBER	SIZE	QTY/BX	LIST PRICE
JPN10080	M10-1.5 X 80	25	
JPN10090	M10-1.5 X 90	25	
JPN10100	M10-1.5 X 100	25	
JPN10120	M10-1.5 X 120	25	
JPN12014X	M12-1.75 X 14	50	
JPN12016	M12-1.75 X 16	50	
JPN12016DIN	M12-1.75 X 16 DIN HEAD	50	
JPN12020	M12-1.75 X 20	50	
JPN12022X	M12-1.75 X 22	50	
JPN12025	M12-1.75 X 25	50	
JPN12030	M12-1.75 X 30	50	
JPN12030DIN	M12-1.75 X 30 DIN HEAD	50	
JPN12035	M12-1.75 X 35	50	
JPN12040	M12-1.75 X 40	50	
JPN12040DIN	M12-1.75 X 40 DIN HEAD	50	
JPN12045	M12-1.75 X 45	50	
JPN12045DIN	M12-1.75 X 45 DIN HEAD	50	
JPN12050	M12-1.75 X 50	50	
JPN12050DIN	M12-1.75 X 50 DIN HEAD	50	
JPN12055	M12-1.75 X 55	50	
JPN12055DIN	M12-1.75 X 55 DIN HEAD	50	
JPN12060	M12-1.75 X 60	50	
JPN12060DIN	M12-1.75 X 60 DIN HEAD	50	
JPN12065	M12-1.75 X 65	50	
JPN12065DIN	M12-1.75 X 65 DIN HEAD	50	
JPN12070	M12-1.75 X 70	50	
JPN12070DIN	M12-1.75 X 70 DIN HEAD	50	
JPN12075	M12-1.75 X 75	25	
JPN12080	M12-1.75 X 80	25	
JPN12080DIN	M12-1.75 X 80 DIN HEAD	25	
JPN12090	M12-1.75 X 90	25	
JPN12100	M12-1.75 X 100	25	
JPN12120	M12-1.75 X 120	25	
JPN12130	M12-1.75 X 130	1	
JPN14020	M14-2.0 X 20	25	
JPN14025	M14-2.0 X 25	25	
JPN14025DIN	M14-2.0 X 25 DIN HEAD	25	
JPN14030	M14-2.0 X 30	25	
JPN14030DIN	M14-2.0 X 30 DIN HEAD	25	
JPN14035	M14-2.0 X 35	25	

(continued...)

**CALL: (800) 723-2826**

### HEX CAP SCREW 8.8 DIN 933 (cont.)

FULLY THREADED - ZINC PLATED

Line: 1642-02

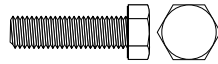

PART NUMBER	SIZE	QTY/BX	LIST PRICE
JPN14035DIN	M14-2.0 X 35 DIN HEAD	25	
JPN14040	M14-2.0 X 40	25	
JPN14040DIN	M14-2.0 X 40 DIN HEAD	25	
JPN14045	M14-2.0 X 45	25	
JPN14050	M14-2.0 X 50	25	
JPN14050DIN	M14-2.0 X 50 DIN HEAD	25	
JPN14055	M14-2.0 X 55	25	
JPN14055DIN	M14-2.0 X 55 DIN HEAD	25	
JPN14060	M14-2.0 X 60	25	
JPN14060DIN	M14-2.0 X 60 DIN HEAD	25	
JPN14070	M14-2.0 X 70	25	
JPN14070DIN	M14-2.0 X 70 DIN HEAD	25	
JPN14080	M14-2.0 X 80	25	
JPN14080DIN	M14-2.0 X 80 DIN HEAD	25	
JPN16020	M16-2.0 X 20	25	
JPN16025	M16-2.0 X 25	25	
JPN16030	M16-2.0 X 30	25	
JPN16035	M16-2.0 X 35	25	
JPN16040	M16-2.0 X 40	25	
JPN16045	M16-2.0 X 45	25	
JPN16050	M16-2.0 X 50	25	
JPN16055	M16-2.0 X 55	25	
JPN16060	M16-2.0 X 60	25	
JPN16065	M16-2.0 X 65	25	
JPN16070	M16-2.0 X 70	25	
JPN16075	M16-2.0 X 75	25	
JPN16080	M16-2.0 X 80	25	
JPN16090	M16-2.0 X 90	25	
JPN16100	M16-2.0 X 100	10	
JPN16120	M16-2.0 X 120	10	
JPN18040	M18-2.5 X 40	25	
JPN18045	M18-2.5 X 45	25	
JPN18050	M18-2.5 X 50	25	
JPN18055	M18-2.5 X 55	25	
JPN18060	M18-2.5 X 60	25	
JPN20030	M20-2.5 X 30	25	
JPN20035	M20-2.5 X 35	10	
JPN20040	M20-2.5 X 40	10	
JPN20045	M20-2.5 X 45	10	
JPN20050	M20-2.5 X 50	10	

(continued...)

### HEX CAP SCREW 8.8 DIN 933 (cont.)

FULLY THREADED - ZINC PLATED

Line: 1642-02

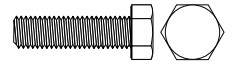

PART NUMBER	SIZE	QTY/BX	LIST PRICE
JPN20055	M20-2.5 X 55	10	
JPN20060	M20-2.5 X 60	10	
JPN20070	M20-2.5 X 70	10	
JPN20080	M20-2.5 X 80	10	
JPN20090	M20-2.5 X 90	10	
JPN20100	M20-2.5 X 100	10	
JPN22050	M22-2.5 X 50	10	
JPN22060	M22-2.5 X 60	10	
JPN24040	M24-3.0 X 40	10	
JPN24045	M24-3.0 X 45	10	
JPN24050	M24-3.0 X 50	10	
JPN24055	M24-3.0 X 55	10	
JPN24060	M24-3.0 X 60	10	
JPN24065	M24-3.0 X 65	10	
JPN24070	M24-3.0 X 70	10	
JPN24075	M24-3.0 X 75	10	
JPN24080	M24-3.0 X 80	10	
JPN30050	M30-3.5 X 50	10	
JPN30060	M30-3.5 X 60	10	
JPN30070	M30-3.5 X 70	10	
JPN30080	M30-3.5 X 80	10	
JPN30090	M30-3.5 X 90	10	
JPN30100	M30-3.5 X 100	10	

**HEX CAP SCREW 8.8 DIN 931**

PARTIAL THREAD - ZINC PLATED

Line: 1642-03

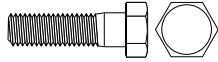

PART NUMBER	SIZE	QTY/BX	LIST PRICE
JRN03040	M3-.5 X 40	100	
JRN04030	M4-.7 X 30	100	
JRN04035	M4-.7 X 35	100	
JRN04040	M4-.7 X 40	100	
JRN04045	M4-.7 X 45	100	
JRN04050	M4-.7 X 50	100	
JRN05030	M5-.8 X 30	100	
JRN05035	M5-.8 X 35	100	
JRN05040	M5-.8 X 40	100	
JRN05045	M5-.8 X 45	100	
JRN05050	M5-.8 X 50	100	
JRN05060	M5-.8 X 60	100	
JRN05070	M5-.8 X 70	100	
JRN05080	M5-.8 X 80	100	
JRN06030	M6-1.0 X 30	100	
JRN06035	M6-1.0 X 35	100	
JRN06040	M6-1.0 X 40	100	
JRN06045	M6-1.0 X 45	100	
JRN06050	M6-1.0 X 50	100	
JRN06055	M6-1.0 X 55	100	
JRN06060	M6-1.0 X 60	100	
JRN06065	M6-1.0 X 65	50	
JRN06070	M6-1.0 X 70	50	
JRN06075	M6-1.0 X 75	50	
JRN06080	M6-1.0 X 80	50	
JRN06090	M6-1.0 X 90	50	
JRN06100	M6-1.0 X 100	50	
JRN07030	M7-1.0 X 30	100	
JRN07035	M7-1.0 X 35	100	
JRN07040	M7-1.0 X 40	100	
JRN07045	M7-1.0 X 45	100	
JRN07050	M7-1.0 X 50	100	
JRN07055	M7-1.0 X 55	100	
JRN07060	M7-1.0 X 60	100	
JRN07070	M7-1.0 X 70	50	
JRN08035	M8-1.25 X 35	100	
JRN08040	M8-1.25 X 40	100	
JRN08045	M8-1.25 X 45	100	
JRN08050	M8-1.25 X 50	50	
JRN08055	M8-1.25 X 55	50	

(continued...)

**HEX CAP SCREW 8.8 DIN 931 (cont.)**

PARTIAL THREAD - ZINC PLATED

Line: 1642-03

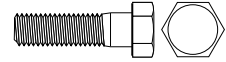

PART NUMBER	SIZE	QTY/BX	LIST PRICE
JRN08060	M8-1.25 X 60	50	
JRN08065	M8-1.25 X 65	50	
JRN08070	M8-1.25 X 70	50	
JRN08075	M8-1.25 X 75	50	
JRN08080	M8-1.25 X 80	50	
JRN08085	M8-1.25 X 85	50	
JRN08090	M8-1.25 X 90	50	
JRN08100	M8-1.25 X 100	25	
JRN08110	M8-1.25 X 110	25	
JRN08120	M8-1.25 X 120	25	
JRN08140	M8-1.25 X 140	25	
JRN08150	M8-1.25 X 150	25	
JRN08160	M8-1.25 X 160	25	
JRN10040	M10-1.5 X 40	100	
JRN10045	M10-1.5 X 45	50	
JRN10050	M10-1.5 X 50	50	
JRN10055	M10-1.5 X 55	50	
JRN10060	M10-1.5 X 60	50	
JRN10065	M10-1.5 X 65	50	
JRN10070	M10-1.5 X 70	50	
JRN10075	M10-1.5 X 75	25	
JRN10080	M10-1.5 X 80	25	
JRN10090	M10-1.5 X 90	25	
JRN10100	M10-1.5 X 100	25	
JRN10110	M10-1.5 X 110	25	
JRN10120	M10-1.5 X 120	25	
JRN10130	M10-1.5 X 130	25	
JRN10140	M10-1.5 X 140	25	
JRN10150	M10-1.5 X 150	25	
JRN10160	M10-1.5 X 160	25	
JRN10180	M10-1.5 X 180	25	
JRN10200	M10-1.5 X 200	25	
JRN12045	M12-1.75 X 45	50	
JRN12050	M12-1.75 X 50	50	
JRN12055	M12-1.75 X 55	50	
JRN12060	M12-1.75 X 60	50	
JRN12065	M12-1.75 X 65	50	
JRN12070	M12-1.75 X 70	50	
JRN12075	M12-1.75 X 75	25	
JRN12080	M12-1.75 X 80	25	

(continued...)

**CALL: (800) 723-2826**

## HEX CAP SCREW 8.8 DIN 931 (cont.)

PARTIAL THREAD - ZINC PLATED

Line: 1642-03

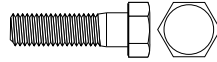

PART NUMBER	SIZE	QTY/BX	LIST PRICE
JRN12090	M12-1.75 X 90	25	
JRN12100	M12-1.75 X 100	25	
JRN12110	M12-1.75 X 110	25	
JRN12120	M12-1.75 X 120	25	
JRN12130	M12-1.75 X 130	25	
JRN12140	M12-1.75 X 140	25	
JRN12150	M12-1.75 X 150	25	
JRN12160	M12-1.75 X 160	25	
JRN12180	M12-1.75 X 180	25	
JRN12200	M12-1.75 X 200	25	
JRN14050X	M14-2.0 X 50	25	
JRN14055X	M14-2.0 X 55	25	
JRN14060X	M14-2.0 X 60	25	
JRN14065X	M14-2.0 X 65	25	
JRN14070X	M14-2.0 X 70	25	
JRN14075X	M14-2.0 X 75	25	
JRN14080	M14-2.0 X 80	25	
JRN14090X	M14-2.0 X 90	25	
JRN14100X	M14-2.0 X 100	25	
JRN14110X	M14-2.0 X 110	25	
JRN14120X	M14-2.0 X 120	25	
JRN14130	M14-2.0 X 130	25	
JRN14150	M14-2.0 X 150	25	
JRN16055	M16-2.0 X 55	25	
JRN16060	M16-2.0 X 60	25	
JRN16065	M16-2.0 X 65	25	
JRN16070	M16-2.0 X 70	25	
JRN16075	M16-2.0 X 75	25	
JRN16080	M16-2.0 X 80	25	
JRN16090	M16-2.0 X 90	25	
JRN16100	M16-2.0 X 100	10	
JRN16110	M16-2.0 X 110	10	
JRN16120	M16-2.0 X 120	10	
JRN16130	M16-2.0 X 130	10	
JRN16140	M16-2.0 X 140	10	
JRN16150	M16-2.0 X 150	10	
JRN16160	M16-2.0 X 160	10	
JRN16180	M16-2.0 X 180	10	
JRN16200	M16-2.0 X 200	10	
JRN18065	M18-2.5 X 65	25	

(continued...)

## HEX CAP SCREW 8.8 DIN 931 (cont.)

PARTIAL THREAD - ZINC PLATED

Line: 1642-03

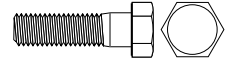

PART NUMBER	SIZE	QTY/BX	LIST PRICE
JRN18070	M18-2.5 X 70	25	
JRN18075	M18-2.5 X 75	25	
JRN18080	M18-2.5 X 80	25	
JRN18090	M18-2.5 X 90	25	
JRN18100	M18-2.5 X 100	10	
JRN18120	M18-2.5 X 120	10	
JRN18130	M18-2.5 X 130	10	
JRN18150	M18-2.5 X 150	10	
JRN20065	M20-2.5 X 65	10	
JRN20070	M20-2.5 X 70	10	
JRN20075	M20-2.5 X 75	10	
JRN20080	M20-2.5 X 80	10	
JRN20090	M20-2.5 X 90	10	
JRN20100	M20-2.5 X 100	10	
JRN20110	M20-2.5 X 110	10	
JRN20120	M20-2.5 X 120	10	
JRN20140	M20-2.5 X 140	10	
JRN20150	M20-2.5 X 150	10	
JRN20160	M20-2.5 X 160	10	
JRN20180	M20-2.5 X 180	10	
JRN20200	M20-2.5 X 200	10	
JRN24065	M24-3.0 X 65	10	
JRN24070	M24-3.0 X 70	10	
JRN24075	M24-3.0 X 75	10	
JRN24080	M24-3.0 X 80	10	
JRN24090	M24-3.0 X 90	10	
JRN24100	M24-3.0 X 100	10	
JRN24110	M24-3.0 X 110	10	
JRN24120	M24-3.0 X 120	10	
JRN24130	M24-3.0 X 130	10	
JRN24140	M24-3.0 X 140	5	
JRN24150	M24-3.0 X 150	5	
JRN24160	M24-3.0 X 160	5	
JRN24180	M24-3.0 X 180	5	
JRN24200	M24-3.0 X 200	5	
JRN30080	M30-3.5 X 80	10	
JRN30090	M30-3.5 X 90	10	
JRN30100	M30-3.5 X 100	10	
JRN30110	M30-3.5 X 110	10	
JRN30120	M30-3.5 X 120	10	

(continued...)

**HEX CAP SCREW 8.8 DIN 931 (cont.)**

PARTIAL THREAD - ZINC PLATED

Line: 1642-03

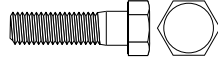

PART NUMBER	SIZE	QTY/BX	LIST PRICE
JRN30130	M30-3.5 X 130	10	
JRN30140	M30-3.5 X 140	10	
JRN30150	M30-3.5 X 150	10	
JRN30160	M30-3.5 X 160	10	
JRN30180	M30-3.5 X 180	10	
JRN30200	M30-3.5 X 200	10	

**HEX CAP SCREW 8.8 DIN 960**

PARTIAL FINE THREAD - ZINC PLATED

Line: 1642-06

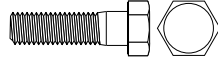

PART NUMBER	SIZE	QTY/BX	LIST PRICE
AAW08035	M8-1.0 X 35	100	
AAW08040	M8-1.0 X 40	100	
AAW08045	M8-1.0 X 45	100	
AAW08050	M8-1.0 X 50	50	
AAW08055	M8-1.0 X 55	50	
AAW08060	M8-1.0 X 60	50	
AAW08065	M8-1.0 X 65	50	
AAW08070	M8-1.0 X 70	50	
AAW08075	M8-1.0 X 75	50	
AAW08080	M8-1.0 X 80	50	
AAW08090	M8-1.0 X 90	50	
AAW08100	M8-1.0 X 100	50	
AAW10040EF	M10-1.0 X 40 EXTRA FINE	100	
AAW10045EF	M10-1.0 X 45 EXTRA FINE	50	
AAW10050EF	M10-1.0 X 50 EXTRA FINE	100	
AAW10055EF	M10-1.0 X 55 EXTRA FINE	50	
AAW10060EF	M10-1.0 X 60 EXTRA FINE	50	
AAW10065EF	M10-1.0 X 65 EXTRA FINE	50	
AAW10070EF	M10-1.0 X 70 EXTRA FINE	50	
AAW10080EF	M10-1.0 X 80 EXTRA FINE	25	
AAW10100EF	M10-1.0 X 100 EXTRA FINE	25	
AAW10040	M10-1.25 X 40	50	
AAW10045	M10-1.25 X 45	50	
AAW10050	M10-1.25 X 50	50	
AAW10055	M10-1.25 X 55	50	
AAW10060	M10-1.25 X 60	50	
AAW10065	M10-1.25 X 65	50	
AAW10070	M10-1.25 X 70	50	
AAW10075	M10-1.25 X 75	25	
AAW10080	M10-1.25 X 80	25	

(continued...)

**HEX CAP SCREW 8.8 DIN 960 (cont.)**

PARTIAL FINE THREAD - ZINC PLATED

Line: 1642-06

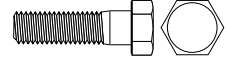

PART NUMBER	SIZE	QTY/BX	LIST PRICE
AAW10090	M10-1.25 X 90	25	
AAW10100	M10-1.25 X 100	25	
AAW10110	M10-1.25 X 110	25	
AAW12045EF	M12-1.25 X 45 EXTRA FINE	50	
AAW12050EF	M12-1.25 X 50 EXTRA FINE	50	
AAW12055EF	M12-1.25 X 55 EXTRA FINE	50	
AAW12060EF	M12-1.25 X 60 EXTRA FINE	50	
AAW12065EF	M12-1.25 X 65 EXTRA FINE	50	
AAW12070EF	M12-1.25 X 70 EXTRA FINE	50	
AAW12075EF	M12-1.25 X 75 EXTRA FINE	25	
AAW12080EF	M12-1.25 X 80 EXTRA FINE	25	
AAW12090EF	M12-1.25 X 90 EXTRA FINE	25	
AAW12100EF	M12-1.25 X 100 EXTRA FINE	25	
AAW12120EF	M12-1.25 X 120 EXTRA FINE	25	
AAW12045	M12-1.5 X 45	50	
AAW12050	M12-1.5 X 50	50	
AAW12055	M12-1.5 X 55	50	
AAW12060	M12-1.5 X 60	50	
AAW12065	M12-1.5 X 65	50	
AAW12070	M12-1.5 X 70	50	
AAW12075	M12-1.5 X 75	25	
AAW12080	M12-1.5 X 80	25	
AAW12090	M12-1.5 X 90	25	
AAW12100	M12-1.5 X 100	25	
AAW12120	M12-1.5 X 120	25	
AAW14045	M14-1.5 X 45	50	
AAW14050X	M14-1.5 X 50	25	
AAW14055X	M14-1.5 X 55	25	
AAW14060X	M14-1.5 X 60	25	
AAW14065	M14-1.5 X 65	25	
AAW14070X	M14-1.5 X 70	25	
AAW14075X	M14-1.5 X 75	25	
AAW14080X	M14-1.5 X 80	25	
AAW14090	M14-1.5 X 90	25	
AAW14100X	M14-1.5 X 100	25	
AAW14120X	M14-1.5 X 120	25	
AAW16050	M16-1.5 X 50	25	
AAW16055	M16-1.5 X 55	25	
AAW16060	M16-1.5 X 60	25	
AAW16070	M16-1.5 X 70	25	

(continued...)

**CALL: (800) 723-2826**

**HEX CAP SCREW 8.8 DIN 960 (cont.)**

PARTIAL FINE THREAD - ZINC PLATED

Line: 1642-06

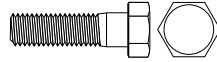

PART NUMBER	SIZE	QTY/BX	LIST PRICE
<b>AAW16080</b>	M16-1.5 X 80	25	
<b>AAW16100</b>	M16-1.5 X 100	10	
<b>AAW16120</b>	M16-1.5 X 120	10	
<b>AAW20070</b>	M20-1.5 X 70	10	
<b>AAW20080</b>	M20-1.5 X 80	10	
<b>AAW20100</b>	M20-1.5 X 100	10	
<b>AAW20120</b>	M20-1.5 X 120	10	
<b>AAW24080</b>	M24-2.0 X 80	10	
<b>AAW24100</b>	M24-2.0 X 100	10	
<b>AAW24120</b>	M24-2.0 X 120	10	

**HEX CAP SCREW 8.8 DIN 961**

FULL FINE THREAD - ZINC PLATED

Line: 1642-07

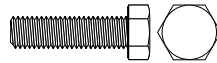

PART NUMBER	SIZE	QTY/BX	LIST PRICE
<b>AAX08010</b>	M8-1.0 X 10	100	
<b>AAX08016</b>	M8-1.0 X 16	100	
<b>AAX08018X</b>	M8-1.0 X 18	100	
<b>AAX08020</b>	M8-1.0 X 20	100	
<b>AAX08022X</b>	M8-1.0 X 22	100	
<b>AAX08025</b>	M8-1.0 X 25	100	
<b>AAX08030</b>	M8-1.0 X 30	100	
<b>AAX08035</b>	M8-1.0 X 35	100	
<b>AAX08040</b>	M8-1.0 X 40	100	
<b>AAX08045</b>	M8-1.0 X 45	100	
<b>AAX08050</b>	M8-1.0 X 50	50	
<b>AAX10016EF</b>	M10-1.0 X 16 EXTRA FINE	100	
<b>AAX10020EF</b>	M10-1.0 X 20 EXTRA FINE	100	
<b>AAX10025EF</b>	M10-1.0 X 25 EXTRA FINE	100	
<b>AAX10030EF</b>	M10-1.0 X 30 EXTRA FINE	100	
<b>AAX10035EF</b>	M10-1.0 X 35 EXTRA FINE	50	
<b>AAX10040EF</b>	M10-1.0 X 40 EXTRA FINE	50	
<b>AAX10045EF</b>	M10-1.0 X 45 EXTRA FINE	50	
<b>AAX10050EF</b>	M10-1.0 X 50 EXTRA FINE	50	
<b>AAX10016</b>	M10-1.25 X 16	100	
<b>AAX10020</b>	M10-1.25 X 20	100	
<b>AAX10022X</b>	M10-1.25 X 22	100	
<b>AAX10025</b>	M10-1.25 X 25	100	
<b>AAX10030</b>	M10-1.25 X 30	100	
<b>AAX10035</b>	M10-1.25 X 35	50	
<b>AAX10040</b>	M10-1.25 X 40	50	

(continued...)

**HEX CAP SCREW 8.8 DIN 961 (cont.)**

FULL FINE THREAD - ZINC PLATED

Line: 1642-07

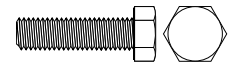

PART NUMBER	SIZE	QTY/BX	LIST PRICE
<b>AAX10045</b>	M10-1.25X 45	50	
<b>AAX10050</b>	M10-1.25 X 50	50	
<b>AAX12020EF</b>	M12-1.25 X 20 EXTRA FINE	50	
<b>AAX12025EF</b>	M12-1.25 X 25 EXTRA FINE	50	
<b>AAX12030EF</b>	M12-1.25 X 30 EXTRA FINE	50	
<b>AAX12035EF</b>	M12-1.25 X 35 EXTRA FINE	50	
<b>AAX12040EF</b>	M12-1.25 X 40 EXTRA FINE	50	
<b>AAX12045EF</b>	M12-1.25 X 45 EXTRA FINE	50	
<b>AAX12050EF</b>	M12-1.25 X 50 EXTRA FINE	50	
<b>AAX12020</b>	M12-1.5 X 20	50	
<b>AAX12025</b>	M12-1.5 X 25	50	
<b>AAX12030</b>	M12-1.5 X 30	50	
<b>AAX12035</b>	M12-1.5 X 35	50	
<b>AAX12040</b>	M12-1.5 X 40	50	
<b>AAX12050</b>	M12-1.5 X 50	50	
<b>AAX14020</b>	M14-1.5 X 20	50	
<b>AAX14025X</b>	M14-1.5 X 25	25	
<b>AAX14030X</b>	M14-1.5 X 30	25	
<b>AAX14035X</b>	M14-1.5 X 35	25	
<b>AAX14040X</b>	M14-1.5 X 40	25	
<b>AAX14045X</b>	M14-1.5 X 45	25	
<b>AAX14050X</b>	M14-1.5 X 50	25	
<b>AAX14055X</b>	M14-1.5 X 55	25	
<b>AAX14060</b>	M14-1.5 X 60	25	
<b>AAX16030</b>	M16-1.5 X 30	25	
<b>AAX16035</b>	M16-1.5 X 35	25	
<b>AAX16040</b>	M16-1.5 X 40	25	
<b>AAX16045</b>	M16-1.5 X 45	25	
<b>AAX16050</b>	M16-1.5 X 50	25	
<b>AAX16055</b>	M16-1.5 X 55	25	
<b>AAX16060</b>	M16-1.5 X 60	25	
<b>AAX16070</b>	M16-1.5 X 70	25	
<b>AAX18040</b>	M18-1.5 X 40	25	
<b>AAX18050</b>	M18-1.5 X 50	25	
<b>AAX20030</b>	M20-1.5 X 30	10	
<b>AAX20035</b>	M20-1.5 X 35	10	
<b>AAX20040</b>	M20-1.5 X 40	10	
<b>AAX20045</b>	M20-1.5 X 45	10	
<b>AAX20050</b>	M20-1.5 X 50	10	
<b>AAX20055</b>	M20-1.5 X 55	10	

(continued...)

**HEX CAP SCREW 8.8 DIN 961 (cont.)**

FULL FINE THREAD - ZINC PLATED

Line: 1642-07

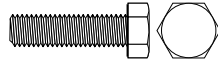

PART NUMBER	SIZE	QTY/BX	LIST PRICE
AAX20060	M20-1.5 X 60	10	
AAX20070	M20-1.5 X 70	10	
AAX20080	M20-1.5 X 80	10	
AAX24050	M24-2.0 X 50	10	
AAX24060	M24-2.0 X 60	10	
AAX24070	M24-2.0 X 70	10	

**HEX CAP SCREW 10.9 DIN 933**

FULL THREAD - YELLOW ZINC

Line: 1643-03

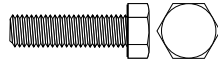

PART NUMBER	SIZE	QTY/BX	LIST PRICE
AAP06010	M6-1.0 X 10	100	
AAP06012	M6-1.0 X 12	100	
AAP06014X	M6-1.0 X 14	100	
AAP06016	M6-1.0 X 16	100	
AAP06018	M6-1.0 X 18	100	
AAP06020	M6-1.0 X 20	100	
AAP06025	M6-1.0 X 25	100	
AAP06030	M6-1.0 X 30	100	
AAP06035	M6-1.0 X 35	100	
AAP08012	M8-1.25 X 12	100	
AAP08014X	M8-1.25 X 14	100	
AAP08016	M8-1.25 X 16	100	
AAP08020	M8-1.25 X 20	100	
AAP08025	M8-1.25 X 25	100	
AAP08030	M8-1.25 X 30	100	
AAP10016	M10-1.5 X 16	100	
AAP10020	M10-1.5 X 20	100	
AAP10025	M10-1.5 X 25	100	
AAP10030	M10-1.5 X 30	100	
AAP10035	M10-1.5 X 35	100	
AAP10040	M10-1.5 X 40	50	
AAP12020	M12-1.75 X 20	50	
AAP12025	M12-1.75 X 25	50	
AAP12030	M12-1.75 X 30	50	
AAP12035	M12-1.75 X 35	50	
AAP12040	M12-1.75 X 40	50	
AAP14025X	M14-2.0 X 25	25	
AAP14030X	M14-2.0 X 30	25	
AAP14035X	M14-2.0 X 35	25	
AAP14040X	M14-2.0 X 40	25	

(continued...)

**HEX CAP SCREW 10.9 DIN 933 (cont.)**

FULL THREAD - YELLOW ZINC

Line: 1643-03

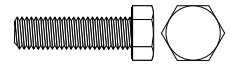

PART NUMBER	SIZE	QTY/BX	LIST PRICE
AAP14045X	M14-2.0 X 45	25	
AAP16030	M16-2.0 X 30	25	
AAP16035	M16-2.0 X 35	25	
AAP16040	M16-2.0 X 40	25	
AAP16045	M16-2.0 X 45	25	
AAP16050	M16-2.0 X 50	25	
AAP16055	M16-2.0 X 55	25	
AAP18030	M18-2.5 X 30	25	
AAP18050	M18-2.5 X 50	25	
AAP18060	M18-2.5 X 60	25	
AAP20040	M20-2.5 X 40	10	
AAP20045	M20-2.5 X 45	10	
AAP20050	M20-2.5 X 50	10	
AAP20055	M20-2.5 X 55	10	
AAP20060	M20-2.5 X 60	10	
AAP20065	M20-2.5 X 65	10	
AAP24040	M24-3.0 X 40	10	
AAP24050	M24-3.0 X 50	10	
AAP24060	M24-3.0 X 60	10	
AAP24070	M24-3.0 X 70	10	

**HEX CAP SCREW 10.9 DIN 931**

PARTIAL THREAD - YELLOW ZINC

Line: 1643-04

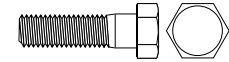

PART NUMBER	SIZE	QTY/BX	LIST PRICE
AAR06025	M6-1.0 X 25	100	
AAR06030	M6-1.0 X 30	100	
AAR06035	M6-1.0 X 35	100	
AAR06040	M6-1.0 X 40	100	
AAR06045	M6-1.0 X 45	100	
AAR06050	M6-1.0 X 50	100	
AAR06055	M6-1.0 X 55	100	
AAR06060	M6-1.0 X 60	100	
AAR06065	M6-1.0 X 65	50	
AAR06070	M6-1.0 X 70	50	
AAR06075	M6-1.0 X 75	50	
AAR06080	M6-1.0 X 80	50	
AAR06090	M6-1.0 X 90	50	
AAR06100	M6-1.0 X 100	50	
AAR08035	M8-1.25 X 35	100	
AAR08040	M8-1.25 X 40	100	

(continued...)



**HEX CAP SCREW 10.9 DIN 931 (cont.)**

PARTIAL THREAD - YELLOW ZINC

Line: 1643-04

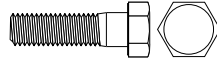

PART NUMBER	SIZE	QTY/BX	LIST PRICE
AAR08045	M8-1.25 X 45	100	
AAR08050	M8-1.25 X 50	50	
AAR08055	M8-1.25 X 55	50	
AAR08060	M8-1.25 X 60	50	
AAR08065	M8-1.25 X 65	50	
AAR08070	M8-1.25 X 70	50	
AAR08075	M8-1.25 X 75	50	
AAR08080	M8-1.25 X 80	50	
AAR08085	M8-1.25 X 85	50	
AAR08090	M8-1.25 X 90	50	
AAR08100	M8-1.25 X 100	50	
AAR08150	M8-1.25 X 150	50	
AAR10040	M10-1.5 X 40	50	
AAR10045	M10-1.5 X 45	50	
AAR10050	M10-1.5 X 50	50	
AAR10055	M10-1.5 X 55	50	
AAR10060	M10-1.5 X 60	50	
AAR10065	M10-1.5 X 65	50	
AAR10070	M10-1.5 X 70	50	
AAR10075	M10-1.5 X 75	25	
AAR10080	M10-1.5 X 80	25	
AAR10090	M10-1.5 X 90	25	
AAR10100	M10-1.5 X 100	25	
AAR10110	M10-1.5 X 110	25	
AAR10120	M10-1.5 X 120	25	
AAR10130	M10-1.5 X 130	25	
AAR10140	M10-1.5 X 140	25	
AAR12040	M12-1.75 X 40	50	
AAR12045	M12-1.75 X 45	50	
AAR12050	M12-1.75 X 50	50	
AAR12055	M12-1.75 X 55	50	
AAR12060	M12-1.75 X 60	50	
AAR12065	M12-1.75 X 65	50	
AAR12070	M12-1.75 X 70	50	
AAR12075	M12-1.75 X 75	25	
AAR12080	M12-1.75 X 80	25	
AAR12085	M12-1.75 X 85	25	
AAR12090	M12-1.75 X 90	25	
AAR12100	M12-1.75 X 100	25	
AAR12110	M12-1.75 X 110	25	

(continued...)

**HEX CAP SCREW 10.9 DIN 931 (cont.)**

PARTIAL THREAD - YELLOW ZINC

Line: 1643-04

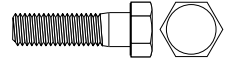

PART NUMBER	SIZE	QTY/BX	LIST PRICE
AAR12120	M12-1.75 X 120	25	
AAR12150	M12-1.75 X 150	25	
AAR14050X	M14-2.0 X 50	25	
AAR14055X	M14-2.0 X 55	25	
AAR14060X	M14-2.0 X 60	25	
AAR14070X	M14-2.0 X 70	25	
AAR14080X	M14-2.0 X 80	25	
AAR14090X	M14-2.0 X 90	25	
AAR14100X	M14-2.0 X 100	25	
AAR14110X	M14-2.0 X 110	25	
AAR14120	M14-2.0 X 120	25	
AAR14150	M14-2.0 X 150	25	
AAR14160	M14-2.0 X 160	25	
AAR16055	M16-2.0 X 55	25	
AAR16060	M16-2.0 X 60	25	
AAR16065	M16-2.0 X 65	25	
AAR16070	M16-2.0 X 70	25	
AAR16075	M16-2.0 X 75	25	
AAR16080	M16-2.0 X 80	25	
AAR16090	M16-2.0 X 90	25	
AAR16100	M16-2.0 X 100	10	
AAR16110	M16-2.0 X 110	10	
AAR16120	M16-2.0 X 120	10	
AAR16130	M16-2.0 X 130	10	
AAR16140	M16-2.0 X 140	10	
AAR16150	M16-2.0 X 150	10	
AAR16160	M16-2.0 X 160	10	
AAR16170	M16-2.0 X 170	10	
AAR16180	M16-2.0 X 180	10	
AAR16190	M16-2.0 X 190	10	
AAR16200	M16-2.0 X 200	10	
AAR16210	M16-2.0 X 210	10	
AAR16220	M16-2.0 X 220	10	
AAR16230	M16-2.0 X 230	10	
AAR16240	M16-2.0 X 240	10	
AAR16250	M16-2.0 X 250	10	
AAR20070	M20-2.5 X 70	10	
AAR20080	M20-2.5 X 80	10	
AAR20090	M20-2.5 X 90	10	
AAR20100	M20-2.5 X 100	10	

(continued...)

**HEX CAP SCREW 10.9 DIN 931 (cont.)**

PARTIAL THREAD - YELLOW ZINC

Line: 1643-04

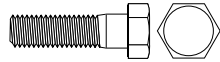
**FLANGE BOLT 10.9 DIN 6921**

YELLOW ZINC

Line: 1643-20

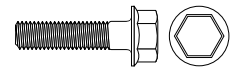
**METRIC PRODUCTS- SECTION 18****PAGE 18-12**

PART NUMBER	SIZE	QTY/BX	LIST PRICE
AAR20110	M20-2.5 X 110	10	
AAR20120	M20-2.5 X 120	10	
AAR20130	M20-2.5 X 130	10	
AAR20140	M20-2.5 X 140	10	
AAR20150	M20-2.5 X 150	10	
AAR20160	M20-2.5 X 160	10	
AAR20170	M20-2.5 X 170	10	
AAR20180	M20-2.5 X 180	10	
AAR20190	M20-2.5 X 190	10	
AAR20200	M20-2.5 X 200	10	
AAR20210	M20-2.5 X 210	10	
AAR20220	M20-2.5 X 220	10	
AAR20230	M20-2.5 X 230	10	
AAR20240	M20-2.5 X 240	10	
AAR20250	M20-2.5 X 250	10	
AAR24080	M24-3.0 X 80	10	
AAR24090	M24-3.0 X 90	10	
AAR24100	M24-3.0 X 100	10	
AAR24110	M24-3.0 X 110	10	
AAR24120	M24-3.0 X 120	10	
AAR24130	M24-3.0 X 130	10	
AAR24140	M24-3.0 X 140	10	
AAR24150	M24-3.0 X 150	10	
AAR24160	M24-3.0 X 160	10	
AAR24170	M24-3.0 X 170	10	
AAR24180	M24-3.0 X 180	10	
AAR24190	M24-3.0 X 190	10	
AAR24200	M24-3.0 X 200	10	
AAR24210	M24-3.0 X 210	10	
AAR24220	M24-3.0 X 220	10	
AAR24230	M24-3.0 X 230	10	
AAR24240	M24-3.0 X 240	10	
AAR24250	M24-3.0 X 250	10	

PART NUMBER	SIZE	QTY/BX	LIST PRICE
BMF06012	M6-1.0 X 12	100	
BMF06012ZP	M6-1.0 X 12	100	
BMF06016	M6-1.0 X 16	100	
BMF06020	M6-1.0 X 20	100	
BMF06025	M6-1.0 X 25	100	
BMF06030	M6-1.0 X 30	100	
BMF08020	M8-1.25 X 20	100	
BMF08025	M8-1.25 X 25	100	
BMF08030	M8-1.25 X 30	100	
BMF08035	M8-1.25 X 35	100	
BMF08040	M8-1.25 X 40	100	
BMF08050	M8-1.25 X 50	100	
BMF10025	M10-1.5 X 25	100	
BMF10030	M10-1.5 X 30	100	
BMF10035	M10-1.5 X 35	100	
BMF10040	M10-1.5 X 40	100	
BMF10050	M10-1.5 X 50	100	
BMF12030	M12-1.75 X 30	100	
BMF12035	M12-1.75 X 35	100	
BMF12040	M12-1.75 X 40	100	
BMF12045	M12-1.75 X 45	50	
BMF12050	M12-1.75 X 50	50	
BMF12060	M12-1.75 X 60	50	
BMF12080	M12-1.75 X 80	50	
BMF12100	M12-1.75 X 100	50	
BMF14040	M14-2.0 X 40	50	
BMF16035	M16-2.0 X 35	50	
BMF16040	M16-2.0 X 40	50	
BMF16050	M16-2.0 X 50	50	

**CALL - 1 (800) 723-2826****CALL: (800) 723-2826**

## HEX NUT DIN 934 CLASS 8

ZINC PLATED (GRADE 5)

Line: 1644-00

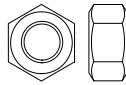

PART NUMBER	SIZE	QTY/BX	LIST PRICE
<b>BNC025</b>	M2.5-.45	100	
<b>BNC03</b>	M3-.5	100	
<b>BNC04</b>	M4-.7	100	
<b>BNC05</b>	M5-.8	100	
<b>BNC06F</b>	M6-.75 FINE	100	
<b>BNC06</b>	M6-1.0	100	
<b>BNC07</b>	M7-1.0	100	
<b>BNC08F</b>	M8-1.0 FINE	100	
<b>BNC08</b>	M8-1.25	100	
<b>BNC10EF</b>	M10-1.0 EXTRA FINE	100	
<b>BNC10F</b>	M10-1.25 FINE	100	
<b>BNC10</b>	M10-1.5	100	
<b>BNC12EF</b>	M12-1.25 EXTRA FINE	100	
<b>BNC12F</b>	M12-1.5 FINE	100	
<b>BNC12</b>	M12-1.75	100	
<b>BNC14FX</b>	M14-1.5 FINE	50	
<b>BNC14X</b>	M14-2.0	50	
<b>BNC16F</b>	M16-1.5 FINE	50	
<b>BNC16</b>	M16-2.0	50	
<b>BNC18FX</b>	M18-1.5 FINE	25	
<b>BNC18</b>	M18-2.5	25	
<b>BNC20F</b>	M20-1.5 FINE	25	
<b>BNC20</b>	M20-2.5	25	
<b>BNC24FX</b>	M24-1.5 EXTRA FINE	25	
<b>BNC24F</b>	M24-2.0 FINE	25	
<b>BNC24</b>	M24-3.0	25	
<b>BNC30</b>	M30-3.5	10	
<b>BNC36</b>	M36-4.0	10	

## HEX NUT DIN 934 CLASS 10

PLAIN FINISH (GRADE 8)

Line: 1644-02

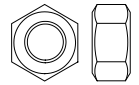

PART NUMBER	SIZE	QTY/BX	LIST PRICE
<b>ABH04</b>	M4-.7	100	
<b>ABH05</b>	M5-.8	100	
<b>ABH06</b>	M6-1.0	100	
<b>ABH08</b>	M8-1.25	100	
<b>ABH10</b>	M10-1.5	100	
<b>ABH12FX</b>	M12-1.5 FINE	100	
<b>ABH12</b>	M12-1.75	100	
<b>ABH14X</b>	M14-2.0	50	
<b>ABH16FX</b>	M16-1.5 FINE	50	
<b>ABH16</b>	M16-2.0	50	
<b>ABH18F</b>	M18-1.5 FINE	25	
<b>ABH18X</b>	M18-2.5	25	
<b>ABH20</b>	M20-2.5	25	
<b>ABH24</b>	M24-3.0	25	
<b>ABH27</b>	M27-3.0	10	
<b>ABH30</b>	M30-3.5	10	
<b>ABH36</b>	M36-4.0	10	

**HEX NUT DIN 934 CLASS 10**

YELLOW ZINC (GRADE 8)

Line: 1644-03

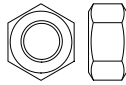

PART NUMBER	SIZE	QTY/BX	LIST PRICE
ATT05	M5-0.8	100	
ATT06	M6-1.0	100	
ATT08F	M8-1.0 FINE	100	
ATT08	M8-1.25	100	
ATT10EF	M10-1.0 EXTRA FINE	100	
ATT10F	M10-1.25 FINE	100	
ATT10	M10-1.5	100	
ATT12EF	M12-1.25 EXTRA FINE	100	
ATT12F	M12-1.5 FINE	100	
ATT12	M12-1.75	100	
ATT14F	M14-1.5 FINE	50	
ATT14	M14-2.0	50	
ATT16F	M16-1.5 FINE	50	
ATT16	M16-2.0	50	
ATT18	M18-2.5	25	
ATT20F	M20-1.5 FINE	25	
ATT20	M20-2.5	25	
ATT24F	M24-2.0 FINE	25	
ATT24	M24-3.0	25	
ATT30	M30-3.5	10	
ATT36	M36-4.0	10	

**MACHINE SCREW NUT DIN 439B**

ZINC PLATED (GRADE 2)

Line: 1645-00

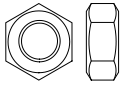

PART NUMBER	SIZE	QTY/BX	LIST PRICE
BPC02	M2-.4	100	
BPC025	M2.5-.45	100	
BPC03	M3-.5	100	
BPC035	M3.5-0.6	100	
BPC04	M4-.7	100	
BPC05	M5-.8	100	
BPC06	M6-1.0	100	
BPC07	M7-1.0	100	
BPC08	M8-1.25	100	
BPC10	M10-1.5	100	

**FLEXLOC NUT**

FULL LIGHT HEX - CADMIUM PLATED

Line: 1645-25

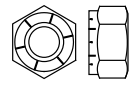

PART NUMBER	SIZE	QTY/BX	LIST PRICE
CEN21MFA8M407	M4-0.7 21MFA8M407	100	
CEN21MFA8M508	M5-0.8 21MFA8M508	100	
CEN21MFA8M610	M6-1.0 21MFA8M610	100	
CEN23MFA8M610	M6-1.0 23MFA8M610-8	100	
CEN21MFA8M812	M8-1.25 21MFA8M8125	100	
CEN21MFA8M101	M10-1.5 21MFA8M1015	100	
CEN21MFA8M121	M12-1.75 21MFA8M1217	100	
CEN21MFA8M142	M14-2.0 21MFA8M1420	50	
CEN21MFA8M162	M16-2.0 21MFA8M1620	50	
CEN31MFA8M182	M18-2.5 31MFA8M1825	50	
CEN31MFA8M202	M20-2.5 31MFA8M2025	50	
CEN31MFA8M243	M24-3.0 31MFA8M2430	25	

**FLEXLOC NUT**

FULL LIGHT HEX - PLAIN FINISH

Line: 1645-26

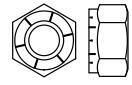

PART NUMBER	SIZE	QTY/BX	LIST PRICE
CEP20MFA8M305	M3-0.5 21MFA8M3050	100	
CEP20MFA8M407	M4-0.7 20MFA8M407	100	
CEP20MFA8M508	M5-0.8 20MFA8M508	100	
CEP20MFA8M610	M6-1.0 20MFA8M610	100	
CEP20MFA8M812	M8-1.25 20MFA8M8125	100	
CEP20MFA8M101	M10-1.5 20MFA8M1015	100	
CEP20MFA8M121	M12-1.75 20MFA8M1217	100	
CEP20MFA8M142	M14-2.0 20MFA8M1420	100	
CEP20MFA8M162	M16-2.0 20MFA8M1620	50	
CEP30MFA8M182	M18-2.5 30MFA8M1825	50	
CEP30MFA8M202	M20-2.5 30MFA8M2025	50	
CEP30MFA8M243	M24-3.0 30MFA8M2430	25	



**CALL - 1 (800) 723-2826**

## NYLON INSERT LOCK NUT - CLASS 10

DIN 985 - YELLOW ZINC (GRADE 8)

Line: 1645-99

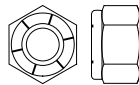

PART NUMBER	SIZE	QTY/BX	LIST PRICE
<b>CBB06</b>	M6-1.0	100	
<b>CBB08</b>	M8-1.25	100	
<b>CBB10</b>	M10-1.50	100	
<b>CBB12</b>	M12-1.75	100	
<b>CBB14</b>	M14-2.0	50	
<b>CBB16</b>	M16-2.0	50	
<b>CBB18</b>	M18-2.5	10	
<b>CBB20</b>	M20-2.5	25	
<b>CBB24</b>	M24-3.0	25	

## NYLON INSERT LOCK NUT - CLASS 8

DIN 985 - ZINC PLATED (GRADE 5)

Line: 1646-00

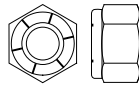

PART NUMBER	SIZE	QTY/BX	LIST PRICE
<b>BRC03</b>	M3-0.5	100	
<b>BRC04</b>	M4-.7	100	
<b>BRC05</b>	M5-.8	100	
<b>BRC06</b>	M6-1.0	100	
<b>BRC07</b>	M7-1.0	100	
<b>BRC08F</b>	M8-1.0 (FINE THREAD)	100	
<b>BRC08</b>	M8-1.25	100	
<b>BRC10EF</b>	M10-1.0 (EXTRA FINE THREAD)	100	
<b>BRC10F</b>	M10-1.25 (FINE THREAD)	100	
<b>BRC10</b>	M10-1.5	100	
<b>BRC12EF</b>	M12-1.25 (EXTRA FINE THREAD)	100	
<b>BRC12F</b>	M12-1.5 (FINE THREAD)	100	
<b>BRC12</b>	M12-1.75	100	
<b>BRC14F</b>	M14-1.5 (FINE THREAD)	50	
<b>BRC14</b>	M14-2.0	50	
<b>BRC16F</b>	M16-1.5 (FINE THREAD)	50	
<b>BRC16</b>	M16-2.0	50	
<b>BRC18</b>	M18-2.5	25	
<b>BRC20</b>	M20-2.5	25	
<b>BRC24</b>	M24-3.0	10	
<b>BRC42F</b>	M42-3.0	4	

## ALL STEEL LOCK NUT - CLASS 10

ZINC PLATED (GRADE C)

Line: 1646-01

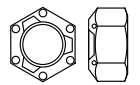

PART NUMBER	SIZE	QTY/BX	LIST PRICE
<b>BSF06</b>	M6-1.0 DIN980V	100	
<b>BSF08</b>	M8-1.25 DIN980V	100	
<b>BSF10</b>	M10-1.5 DIN980V	100	
<b>BSF12</b>	M12-1.75 DIN980V	100	
<b>BSF14</b>	M14-2.0 DIN980V	50	
<b>BSF16</b>	M16-2.0 DIN980V	50	
<b>BSF18</b>	M18-2.5 DIN980V	25	
<b>BSF20</b>	M20-2.5 DIN980V	25	
<b>BSF24</b>	M24-3.0 DIN980V	25	

## NYLON INSERT LOCK NUT

A2 - 304 STAINLESS STEEL - DIN 985

Line: 1646-02

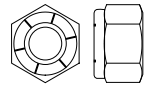

PART NUMBER	SIZE	QTY/BX	LIST PRICE
<b>AAV03</b>	M3-.5	100	
<b>AAV04</b>	M4-.7	100	
<b>AAV05</b>	M5-.08	100	
<b>AAV06</b>	M6-1.0	100	
<b>AAV08</b>	M8-1.25	100	
<b>AAV10</b>	M10-1.5	100	
<b>AAV12</b>	M12-1.75	100	
<b>AAV14</b>	M14-2.0	50	
<b>AAV16</b>	M16-2.0	50	

## WING NUT - DIN 315 - CAST

ZINC PLATED OR FORGED STEEL

Line: 1646-03

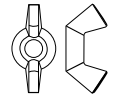

PART NUMBER	SIZE	QTY/BX	LIST PRICE
<b>BTV06</b>	M6-1.0	100	
<b>BTV08</b>	M8-1.25	100	
<b>BTV10</b>	M10-1.5	100	
<b>BTV12</b>	M12-1.75	100	
<b>BTV14</b>	M14-2.0	50	
<b>BTV16</b>	M16-2.0	50	
<b>BTV20</b>	M20-2.5	25	

**NOTE:** SIZES M6 THRU M12 WILL REPLACE DIN 315 STYLE WITH FORGED STEEL WHEN PRESENT STOCKS ARE DEPLETED. M14 THRU M20 WILL REMAIN DIN 315 (CAST IRON).

### HEX JAM NUT CLASS 4 DIN 439

PLAIN FINISH (GRADE 2)

Line: 1646-05



PART NUMBER	SIZE	QTY/BX	LIST PRICE
<b>ABF06</b>	M6-1.0	100	
<b>ABF08</b>	M8-1.25	100	
<b>ABF10</b>	M10-1.50	100	
<b>ABF12</b>	M12-1.75	100	
<b>ABF16</b>	M16-2.0	50	

### HEX ROD COUPLING NUT - DIN 6334

ZINC PLATED

Line: 1646-06



PART NUMBER	SIZE	QTY/BX	LIST PRICE
<b>CEL04</b>	M4-.7	25	
<b>CEL05</b>	M5-.8	25	
<b>CEL06</b>	M6-1.0	25	
<b>CEL08</b>	M8-1.25	25	
<b>CEL10</b>	M10-1.5	25	
<b>CEL12</b>	M12-1.75	25	
<b>CEL16</b>	M16-2.0	10	
<b>CEL20</b>	M20-2.5	10	
<b>CEL24</b>	M24-3.0	10	

### FLANGE NUT DIN 6923 - CLASS 10

ZINC PLATED - NO SERRATION (GRADE 8)

Line: 1646-99

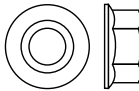

PART NUMBER	SIZE	QTY/BX	LIST PRICE
<b>CHG05</b>	M5-.8 Y/Z NON-SERR	100	
<b>CHG10</b>	M10-1.5 NON-SERR	100	
<b>CHG14</b>	M14-2.0 NON-SERR	50	
<b>CHG16</b>	M16-2.0 NON-SERR	50	

### HEX JAM NUT DIN 439 - CLASS 6

ZINC PLATED (GRADE 2)

Line: 1647-00

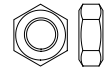

PART NUMBER	SIZE	QTY/BX	LIST PRICE
<b>BSC03</b>	M3-0.5	100	
<b>BSC04</b>	M4-0.7	100	
<b>BSC05</b>	M5-0.8	100	
<b>BSC06</b>	M6-1.0	100	
<b>BSC07X</b>	M7-1.0	100	
<b>BSC08F</b>	M8-1.0 FINE	100	
<b>BSC08</b>	M8-1.25	100	
<b>BSC10EF</b>	M10-1.0 EXTRA FINE	100	
<b>BSC10F</b>	M10-1.25 FINE	100	
<b>BSC10</b>	M10-1.5	100	
<b>BSC12EF</b>	M12-1.25 EXTRA FINE	100	
<b>BSC12F</b>	M12-1.5 FINE	100	
<b>BSC12</b>	M12-1.75	100	
<b>BSC14F</b>	M14-1.5 FINE	50	
<b>BSC14X</b>	M14-2.0	50	
<b>BSC16F</b>	M16-1.5 FINE	50	
<b>BSC16</b>	M16-2.0	50	
<b>BSC18X</b>	M18-2.5	25	
<b>BSC20F</b>	M20-1.5 FINE	25	
<b>BSC20</b>	M20-2.5	25	
<b>BSC24EF</b>	M24-1.5 EXTRA FINE	25	
<b>BSC24</b>	M24-3.0	25	
<b>BSC30</b>	M30-3.5	10	

### FLANGE NUT DIN 6923 - CLASS 10

ZINC PLATED - SERRATED (GRADE 8)

Line: 1647-01



PART NUMBER	SIZE	QTY/BX	LIST PRICE
<b>BME06</b>	M6-1.0 SERRATED	100	
<b>BME08</b>	M8-1.25 SERRATED	100	
<b>BME10F</b>	M10-1.25 CL8 SERRATED FINE	100	
<b>BME10</b>	M10-1.5 SERRATED	100	
<b>BME12</b>	M12-1.75 SERRATED	100	
<b>BME14</b>	M14-2.0 SERRATED	50	
<b>BME16</b>	M16-2.0 SERRATED	50	

## HEAVY DUTY FLAT WASHER DIN 125B

ZINC PLATED

Line: 1647-04

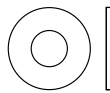

PART NUMBER	SIZE	QTY/BX	LIST PRICE
ABE06	M6	100	
ABE07	M7	100	
ABE08	M8	100	
ABE10	M10	100	
ABE12	M12	100	
ABE16	M16	100	
ABE18X	M18	50	
ABE24	M24	25	
ABE30	M30	25	
ABE36	M36	25	

## FLAT WASHER 10.9 DIN 125A

YELLOW ZINC - HARDENED

Line: 1647-06

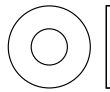

PART NUMBER	SIZE	QTY/BX	LIST PRICE
ABK05	M5 200HV	100	
ABK06	M6 200HV	100	
ABK08	M8 200HV	100	
ABK10	M10 200HV	100	
ABK12	M12 200HV	100	
ABK14X	M14 200HV	50	
ABK16	M16 200HV	50	
ABK18	M18 200HV	25	
ABK20X	M20 200HV	25	
ABK24	M24 200HV	50	

## FLAT WASHER DIN 125A

ZINC PLATED

Line: 1648-00



PART NUMBER	SIZE	QTY/BX	LIST PRICE
BUC02	M2	100	
BUC025	M2.5	100	
BUC03	M3	100	
BUC04	M4	100	
BUC05	M5	100	
BUC06	M6	100	
BUC07	M7	100	
BUC08	M8	100	
BUC10	M10	100	
BUC12	M12	100	
BUC14	M14	100	
BUC16	M16	100	
BUC18X	M18	50	
BUC20	M20	50	
BUC24	M24	25	
BUC30	M30	25	

## SPLIT LOCKWASHER DIN 127B

ZINC PLATED

Line: 1649-00

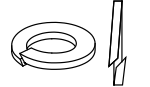

PART NUMBER	SIZE	QTY/BX	LIST PRICE
BWC02	M2	100	
BWC025	M2.5	100	
BWC03	M3	100	
BWC04	M4	100	
BWC05	M5	100	
BWC06	M6	100	
BWC07	M7	100	
BWC08	M8	100	
BWC10	M10	100	
BWC12	M12	100	
BWC14X	M14	100	
BWC16	M16	100	
BWC18X	M18	50	
BWC20	M20	50	
BWC22	M22	50	
BWC24	M24	50	
BWC30	M30	25	

**EXTERNAL TOOTH LOCKWASHER**

DIN 6797A - ZINC PLATED

Line: 1650-00

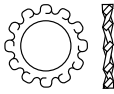

PART NUMBER	SIZE	QTY/BX	LIST PRICE
BXC02	M2	100	
BXC03	M3	100	
BXC04	M4	100	
BXC05	M5	100	
BXC06	M6	100	
BXC07	M7	100	
BXC08	M8	100	
BXC10	M10	100	
BXC12	M12	100	
BXC16	M16	100	

**INTERNAL LOCKWASHER**

DIN 6797J - ZINC PLATED

Line: 1651-00



PART NUMBER	SIZE	QTY/BX	LIST PRICE
BYC03	M3	100	
BYC04	M4	100	
BYC05	M5	100	
BYC06	M6	100	
BYC07	M7	100	
BYC08	M8	100	
BYC10	M10	100	
BYC12	M12	100	
BYC16	M16	100	

**SPRING WAVE WASHER**

DIN 137B - ZINC PLATED

Line: 1652-00

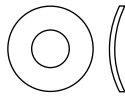

PART NUMBER	SIZE	QTY/BX	LIST PRICE
BVC03	M3	100	
BVC04	M4	100	
BVC05	M5	100	
BVC06	M6	100	
BVC07	M7	100	
BVC08	M8	100	
BVC10	M10	100	
BVC12	M12	100	
BVC14	M14	100	
BVC16	M16	50	
BVC20	M20	50	

**SOCKET CAP SCREW**

12.9 DIN 912 - PLAIN FINISH

Line: 1653-00

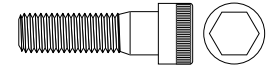

PART NUMBER	SIZE	QTY/BX	LIST PRICE
CDC02004	M2-.4 X 4	100	
CDC02006	M2-.4 X 6	100	
CDC02010	M2-.4 X 10	100	
CDC02016	M2-.4 X 16	100	
CDC02020	M2-.4 X 20	100	
CDC25005	M2.5-.45 X 5	100	
CDC25008	M2.5-.45 X 8	100	
CDC25010	M2.5-.45 X 10	100	
CDC25016	M2.5-.45 X 16	100	
CDC25020	M2.5-.45 X 20	100	
CDC25025	M2.5-.45 X 25	100	
CDC03005	M3-.5 X 5	100	
CDC03006	M3-.5 X 6	100	
CDC03008	M3-.5 X 8	100	
CDC03010	M3-.5 X 10	100	
CDC03012	M3-.5 X 12	100	
CDC03014	M3-.5 X 14	100	
CDC03016	M3-.5 X 16	100	
CDC03018	M3-.5 X 18	100	
CDC03020	M3-.5 X 20	100	
CDC03022	M3-.5 X 22	100	
CDC03025	M3-.5 X 25	100	
CDC03030	M3-.5 X 30	100	
CDC03035	M3-.5 X 35	100	
CDC03040	M3-.5 X 40	100	
CDC35008	M3.5-.6 X 8	100	
CDC04005	M4-.7 X 5	100	
CDC04006	M4-.7 X 6	100	
CDC04008	M4-.7 X 8	100	
CDC04010	M4-.7 X 10	100	
CDC04012	M4-.7 X 12	100	
CDC04014	M4-.7 X 14	100	
CDC04016	M4-.7 X 16	100	
CDC04018	M4-.7 X 18	100	
CDC04020	M4-.7 X 20	100	
CDC04022	M4-.7 X 22	100	
CDC04025	M4-.7 X 25	100	
CDC04030	M4-.7 X 30	100	
CDC04035	M4-.7 X 35	100	

(continued...)

**CALL: (800) 723-2826**



**SOCKET CAP SCREW (cont.)**

12.9 DIN 912 - PLAIN FINISH

Line: 1653-00

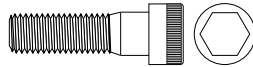

PART NUMBER	SIZE	QTY/BX	LIST PRICE
CDC04040	M4-.7 X 40	100	
CDC04045	M4-.7 X 45	100	
CDC04050	M4-.7 X 50	100	
CDC05006	M5-.8 X 6	100	
CDC05008	M5-.8 X 8	100	
CDC05010	M5-.8 X 10	100	
CDC05012	M5-.8 X 12	100	
CDC05016	M5-.8 X 16	100	
CDC05018	M5-.8 X 18	100	
CDC05020	M5-.8 X 20	100	
CDC05022	M5-.8 X 22	100	
CDC05025	M5-.8 X 25	100	
CDC05030	M5-.8 X 30	100	
CDC05035	M5-.8 X 35	100	
CDC05040	M5-.8 X 40	100	
CDC05045	M5-.8 X 45	100	
CDC05050	M5-.8 X 50	100	
CDC05055	M5-.8 X 55	100	
CDC05060	M5-.8 X 60	100	
CDC05065	M5-.8 X 65	100	
CDC05070	M5-.8 X 70	100	
CDC05075	M5-.8 X 75	100	
CDC05090	M5-.8 X 90	100	
CDC05100	M5-.8 X 100	100	
CDC06006	M6-1.0 X 6	100	
CDC06008	M6-1.0 X 8	100	
CDC06010	M6-1.0 X 10	100	
CDC06012	M6-1.0 X 12	100	
CDC06014X	M6-1.0 X 14	100	
CDC06016	M6-1.0 X 16	100	
CDC06018	M6-1.0 X 18	100	
CDC06020	M6-1.0 X 20	100	
CDC06022	M6-1.0 X 22	100	
CDC06025	M6-1.0 X 25	100	
CDC06030	M6-1.0 X 30	100	
CDC06035	M6-1.0 X 35	100	
CDC06040	M6-1.0 X 40	100	
CDC06045	M6-1.0 X 45	100	
CDC06050	M6-1.0 X 50	100	

(continued...)

**SOCKET CAP SCREW (cont.)**

12.9 DIN 912 - PLAIN FINISH

Line: 1653-00

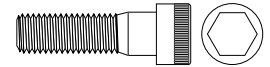

PART NUMBER	SIZE	QTY/BX	LIST PRICE
CDC06055	M6-1.0 X 55	100	
CDC06060	M6-1.0 X 60	100	
CDC06065	M6-1.0 X 65	50	
CDC06070	M6-1.0 X 70	50	
CDC06075	M6-1.0 X 75	50	
CDC06080	M6-1.0 X 80	50	
CDC06085	M6-1.0 X 85	50	
CDC06090	M6-1.0 X 90	50	
CDC06100	M6-1.0 X 100	50	
CDC06110	M6-1.0 X 110	50	
CDC06120	M6-1.0 X 120	50	
CDC06130	M6-1.0 X 130	50	
CDC06150	M6-1.0 X 150	50	
CDC08010	M8-1.25 X 10	100	
CDC08012	M8-1.25 X 12	100	
CDC08016	M8-1.25 X 16	100	
CDC08018	M8-1.25 X 18	100	
CDC08020	M8-1.25 X 20	100	
CDC08022	M8-1.25 X 22	100	
CDC08025	M8-1.25 X 25	100	
CDC08030	M8-1.25 X 30	50	
CDC08035	M8-1.25 X 35	100	
CDC08040	M8-1.25 X 40	100	
CDC08045	M8-1.25 X 45	100	
CDC08050	M8-1.25 X 50	50	
CDC08055	M8-1.25 X 55	50	
CDC08060	M8-1.25 X 60	50	
CDC08065	M8-1.25 X 65	50	
CDC08070	M8-1.25 X 70	50	
CDC08075	M8-1.25 X 75	50	
CDC08080	M8-1.25 X 80	50	
CDC08090	M8-1.25 X 90	50	
CDC08100	M8-1.25 X 100	25	
CDC08110	M8-1.25 X 110	25	
CDC08120	M8-1.25 X 120	25	
CDC08170	M8-1.25 X 170	25	
CDC10012	M10-1.5 X 12	100	
CDC10016	M10-1.5 X 16	100	
CDC10018	M10-1.5 X 18	100	

(continued...)

**SOCKET CAP SCREW (cont.)**

12.9 DIN 912 - PLAIN FINISH

Line: 1653-00

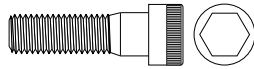

PART NUMBER	SIZE	QTY/BX	LIST PRICE
CDC10020	M10-1.5 X 20	100	
CDC10022	M10-1.5 X 22	100	
CDC10025	M10-1.5 X 25	100	
CDC10030	M10-1.5 X 30	50	
CDC10035	M10-1.5 X 35	50	
CDC10040	M10-1.5 X 40	50	
CDC10045	M10-1.5 X 45	50	
CDC10050	M10-1.5 X 50	50	
CDC10055	M10-1.5 X 55	50	
CDC10060	M10-1.5 X 60	50	
CDC10065	M10-1.5 X 65	50	
CDC10070	M10-1.5 X 70	50	
CDC10075	M10-1.5 X 75	25	
CDC10080	M10-1.5 X 80	25	
CDC10085	M10-1.5 X 85	25	
CDC10090	M10-1.5 X 90	25	
CDC10100	M10-1.5 X 100	25	
CDC10110	M10-1.5 X 110	25	
CDC10120	M10-1.5 X 120	25	
CDC10130	M10-1.5 X 130	25	
CDC10150	M10-1.5 X 150	25	
CDC12020	M12-1.75 X 20	50	
CDC12022	M12-1.75 X 22	50	
CDC12025	M12-1.75X 25	50	
CDC12030	M12-1.75X 30	50	
CDC12035	M12-1.75X 35	50	
CDC12040	M12-1.75 X 40	50	
CDC12045	M12-1.75X 45	50	
CDC12050	M12-1.75X 50	50	
CDC12055	M12-1.75 X 55	50	
CDC12060	M12-1.75 X 60	50	
CDC12065	M12-1.75 X 65	50	
CDC12070	M12-1.75X 70	50	
CDC12075	M12-1.75 X 75	25	
CDC12080	M12-1.75X 80	25	
CDC12085	M12-1.75 X 85	25	
CDC12090	M12-1.75 X 90	25	
CDC12100	M12-1.75 X100	25	
CDC12110	M12-1.75 X110	25	

(continued...)

**SOCKET CAP SCREW (cont.)**

12.9 DIN 912 - PLAIN FINISH

Line: 1653-00

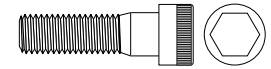

PART NUMBER	SIZE	QTY/BX	LIST PRICE
CDC12120	M12-1.75 X120	25	
CDC12130	M12-1.75 X130	25	
CDC12140	M12-1.75 X140	25	
CDC12150	M12-1.75 X150	25	
CDC12160	M12-1.75 X 160	25	
CDC12180	M12-1.75 X 180	25	
CDC14020	M14-2.0 X 20	50	
CDC14025	M14-2.0 X 25	50	
CDC14030	M14-2.0 X 30	50	
CDC14035X	M14-2.0 X 35	50	
CDC14040	M14-2.0 X 40	25	
CDC14045	M14-2.0 X 45	25	
CDC14050	M14-2.0 X 50	25	
CDC14055	M14-2.0 X 55	25	
CDC14060	M14-2.0 X 60	25	
CDC14065	M14-2.0 X 65	25	
CDC14070X	M14-2.0 X 70	25	
CDC14080	M14-2.0 X 80	25	
CDC14090	M14-2.0 X 90	25	
CDC14100	M14-2.0 X 100	25	
CDC14120	M14-2.0 X 120	25	
CDC14130	M14-2.0 X 130	25	
CDC14140	M14-2.0 X 140	25	
CDC16030	M16-2.0 X 30	25	
CDC16035	M16-2.0 X 35	25	
CDC16040	M16-2.0 X 40	25	
CDC16045	M16-2.0 X 45	25	
CDC16050	M16-2.0 X 50	25	
CDC16055	M16-2.0 X 55	25	
CDC16060	M16-2.0 X 60	25	
CDC16065	M16-2.0 X 65	25	
CDC16070	M16-2.0 X 70	25	
CDC16075	M16-2.0 X 75	25	
CDC16080	M16-2.0 X 80	25	
CDC16085	M16-2.0 X 85	25	
CDC16090	M16-2.0 X 90	25	
CDC16100	M16-2.0 X 100	25	
CDC16110	M16-2.0 X 110	10	
CDC16120	M16-2.0 X 120	10	

(continued...)

**SOCKET CAP SCREW (cont.)**

12.9 DIN 912 - PLAIN FINISH

Line: 1653-00

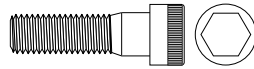

PART NUMBER	SIZE	QTY/BX	LIST PRICE
CDC16130	M16-2.0 X 130	10	
CDC16140	M16-2.0 X 140	10	
CDC16150	M16-2.0 X 150	10	
CDC16160	M16-2.0 X 160	10	
CDC18055	M18-2.5 X 55	25	
CDC20030	M20-2.5 X 30	10	
CDC20040	M20-2.5 X 40	10	
CDC20045	M20-2.5 X 45	10	
CDC20050	M20-2.5 X 50	10	
CDC20055	M20-2.5 X 55	10	
CDC20060	M20-2.5 X 60	10	
CDC20065	M20-2.5 X 65	10	
CDC20070	M20-2.5 X 70	10	
CDC20075	M20-2.5 X 75	10	
CDC20080	M20-2.5 X 80	10	
CDC20085	M20-2.5 X 85	10	
CDC20090	M20-2.5 X 90	10	
CDC20100	M20-2.5 X 100	10	
CDC20110	M20-2.5 X 110	10	
CDC20120	M20-2.5 X 120	10	
CDC20130	M20-2.5 X 130	10	
CDC20140	M20-2.5 X 140	10	
CDC20150	M20-2.5 X 150	10	
CDC22045	M22-2.5 X 45	10	
CDC24045	M24-3.0 X 45	10	
CDC24050	M24-3.0 X 50	10	
CDC24055	M24-3.0 X 55	10	
CDC24060	M24-3.0 X 60	10	
CDC24065	M24-3.0 X 65	10	
CDC24070	M24-3.0 X 70	10	
CDC24075	M24-3.0 X 75	10	
CDC24080	M24-3.0 X 80	10	
CDC24090	M24-3.0 X 90	10	
CDC24100	M24-3.0 X 100	10	
CDC24110	M24-3.0 X 110	10	
CDC24120	M24-3.0 X 120	10	
CDC24130	M24-3.0 X 130	10	
CDC24140	M24-3.0 X 140	10	
CDC24150	M24-3.0 X 150	10	

(continued...)

**SOCKET CAP SCREW (cont.)**

12.9 DIN 912 - PLAIN FINISH

Line: 1653-00

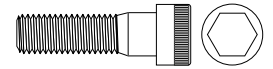

PART NUMBER	SIZE	QTY/BX	LIST PRICE
CDC24160	M24-3.0 X 160	10	
CDC24180	M24-3.0 X 180	10	
CDC24200	M24-3.0 X 200	10	
CDC24220	M24-3.0 X 220	10	
CDC30060	M30-3.5 X 60	10	
CDC30080	M30-3.5 X 80	10	
CDC30120	M30-3.5 X 120	5	

**FLAT SOCKET CAP SCREW**

10.9 DIN 7991 - PLAIN FINISH

Line: 1654-00

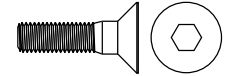

PART NUMBER	SIZE	QTY/BX	LIST PRICE
CFC02006	M2-.4 X 6	100	
CFC02010	M2-.4 X 10	100	
CFC02012	M2-.4 X 12	100	
CFC02016	M2-.4 X 16	100	
CFC02020	M2-.4 X 20	100	
CFC25006	M2.5-.45 X 6	100	
CFC25010	M2.5-.45 X 10	100	
CFC25012	M2.5-.45 X 12	100	
CFC25016	M2.5-.45 X 16	100	
CFC03006	M3-.5 X 6	100	
CFC03008	M3-.5 X 8	100	
CFC03010	M3-.5 X 10	100	
CFC03012	M3-.5 X 12	100	
CFC03016	M3-.5 X 16	100	
CFC03020	M3-.5 X 20	100	
CFC03025	M3-.5 X 25	100	
CFC03030	M3-.5 X 30	100	
CFC04008	M4-.7 X 8	100	
CFC04010	M4-.7 X 10	100	
CFC04012	M4-.7 X 12	100	
CFC04014	M4-.7 X 14	100	
CFC04016	M4-.7 X 16	100	
CFC04020	M4-.7 X 20	100	
CFC04025	M4-.7 X 25	100	
CFC04030	M4-.7 X 30	100	
CFC04035	M4-.7 X 35	100	
CFC04040	M4-.7 X 40	100	
CFC04050	M4-.7 X 50	100	

(continued...)

**FLAT SOCKET CAP SCREW (cont.)**

10.9 DIN 7991 - PLAIN FINISH

Line: 1654-00

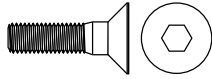

PART NUMBER	SIZE	QTY/BX	LIST PRICE
CFC05008	M5-.8 X 8	100	
CFC05010	M5-.8 X 10	100	
CFC05012	M5-.8 X 12	100	
CFC05016	M5-.8 X 16	100	
CFC05020	M5-.8 X 20	100	
CFC05025	M5-.8 X 25	100	
CFC05030	M5-.8 X 30	100	
CFC05035	M5-.8 X 35	100	
CFC05040	M5-.8 X 40	100	
CFC05050	M5-.8 X 50	50	
CFC05060	M5-.8 X 60	50	
CFC06008	M6-1.0 X 8	100	
CFC06010	M6-1.0 X 10	100	
CFC06012	M6-1.0 X 12	100	
CFC06016	M6-1.0 X 16	100	
CFC06020	M6-1.0 X 20	100	
CFC06025	M6-1.0 X 25	100	
CFC06030	M6-1.0 X 30	100	
CFC06035	M6-1.0 X 35	100	
CFC06040	M6-1.0 X 40	100	
CFC06045	M6-1.0 X 45	100	
CFC06050	M6-1.0 X 50	50	
CFC08010	M8-1.25 X 10	100	
CFC08012	M8-1.25 X 12	100	
CFC08016	M8-1.25 X 16	100	
CFC08020	M8-1.25 X 20	100	
CFC08025	M8-1.25 X 25	100	
CFC08030	M8-1.25 X 30	100	
CFC08035	M8-1.25 X 35	100	
CFC08040	M8-1.25 X 40	100	
CFC08045	M8-1.25 X 45	100	
CFC08050	M8-1.25 X 50	50	
CFC08060	M8-1.25 X 60	50	
CFC08090	M8-1.25 X 90	50	
CFC10012	M10-1.5 X 12	100	
CFC10016	M10-1.5 X 16	100	
CFC10020	M10-1.5 X 20	100	
CFC10025	M10-1.5 X 25	100	
CFC10030	M10-1.5 X 30	50	
CFC10035	M10-1.5 X 35	50	

(continued...)

**FLAT SOCKET CAP SCREW (cont.)**

10.9 DIN 7991 - PLAIN FINISH

Line: 1654-00

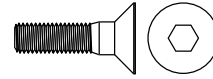

PART NUMBER	SIZE	QTY/BX	LIST PRICE
CFC10040	M10-1.5 X 40	50	
CFC10045	M10-1.5 X 45	50	
CFC10050	M10-1.5 X 50	50	
CFC10060	M10-1.5 X 60	50	
CFC10070	M10-1.5 X 70	25	
CFC10080	M10-1.5 X 80	25	
CFC12020	M12-1.75X 20	50	
CFC12025	M12-1.75X 25	50	
CFC12030	M12-1.75X 30	50	
CFC12035	M12-1.75X 35	50	
CFC12040	M12-1.75X 40	50	
CFC12045	M12-1.75 X 45	50	
CFC12050	M12-1.75X 50	50	
CFC12055	M12-1.75 X 55	50	
CFC12060	M12-1.75X 60	50	
CFC12070	M12-1.75 X 70	25	
CFC16030	M16-2.0 X 30	25	
CFC16035	M16-2.0 X 35	25	
CFC16040	M16-2.0 X 40	25	
CFC16045	M16-2.0 X 45	25	
CFC16050	M16-2.0 X 50	25	
CFC16060	M16-2.0 X 60	25	
CFC16070	M16-2.0 X 70	25	
CFC16080	M16-2.0 X 80	25	



**CALL - 1 (800) 723-2826**

**CALL: (800) 723-2826**

# SOCKET SET SCREW CUP POINT

DIN 916 - PLAIN FINISH

Line: 1655-00

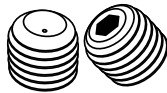

PART NUMBER	SIZE	QTY/BX	LIST PRICE
CCC02004	M2-.4 X 4	100	
CCC02008	M2-.4 X 8	100	
CCC25005	M2.5-.45 X 5	100	
CCC03003	M3-.5 X 3	100	
CCC03004	M3-.5 X 4	100	
CCC03005	M3-.5 X 5	100	
CCC03006	M3-.5 X 6	100	
CCC03008	M3-.5 X 8	100	
CCC03010	M3-.5 X 10	100	
CCC03012	M3-.5 X 12	100	
CCC03014X	M3-.5 X 14	100	
CCC03016	M3-.5 X 16	100	
CCC03020	M3-.5 X 20	100	
CCC04004	M4-.7 X 4	100	
CCC04005	M4-.7 X 5	100	
CCC04006	M4-.7 X 6	100	
CCC04008	M4-.7 X 8	100	
CCC04010	M4-.7 X 10	100	
CCC04012	M4-.7 X 12	100	
CCC04014X	M4-.7 X 14	100	
CCC04016	M4-.7 X 16	100	
CCC04020	M4-.7 X 20	100	
CCC04025	M4-.7 X 25	100	
CCC04030	M4-.7 X 30	100	
CCC04035	M4-.7 X 35	100	
CCC04040	M4-.7 X 40	100	
CCC05005	M5-.8 X 5	100	
CCC05006	M5-.8 X 6	100	
CCC05008	M5-.8 X 8	100	
CCC05010	M5-.8 X 10	100	
CCC05012	M5-.8 X 12	100	
CCC05014X	M5-.8 X 14	100	
CCC05016	M5-.8 X 16	100	
CCC05018X	M5-.8 X 18	100	
CCC05020	M5-.8 X 20	100	
CCC05025	M5-.8 X 25	100	
CCC05025Q50	M5-.8 X 25	50	
CCC05030	M5-.8 X 30	100	
CCC05035	M5-.8 X 35	100	
CCC05040	M5-.8 X 40	100	

(continued...)

# SOCKET SET SCREW CUP POINT (cont.)

DIN 916 - PLAIN FINISH

Line: 1655-00

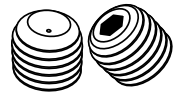

PART NUMBER	SIZE	QTY/BX	LIST PRICE
CCC06005	M6-1.0 X 5	100	
CCC06006	M6-1.0 X 6	100	
CCC06008	M6-1.0 X 8	100	
CCC06010	M6-1.0 X 10	100	
CCC06012	M6-1.0 X 12	100	
CCC06014X	M6-1.0 X 14	100	
CCC06016	M6-1.0 X 16	100	
CCC06018X	M6-1.0 X 18	100	
CCC06020	M6-1.0 X 20	100	
CCC06025	M6-1.0 X 25	100	
CCC06030	M6-1.0 X 30	100	
CCC06035	M6-1.0 X 35	100	
CCC06040	M6-1.0 X 40	100	
CCC06045	M6-1.0 X 45	100	
CCC06050	M6-1.0 X 50	50	
CCC08006	M8-1.25 X 6	100	
CCC08008	M8-1.25 X 8	100	
CCC08010	M8-1.25 X 10	100	
CCC08012	M8-1.25 X 12	100	
CCC08014X	M8-1.25 X 14	100	
CCC08016	M8-1.25 X 16	100	
CCC08020	M8-1.25 X 20	100	
CCC08025	M8-1.25 X 25	100	
CCC08030	M8-1.25 X 30	100	
CCC08035	M8-1.25 X 35	100	
CCC08045	M8-1.25 X 45	100	
CCC08050	M8-1.25 X 50	50	
CCC08060	M8-1.25 X 60	50	
CCC10010	M10-1.5 X 10	100	
CCC10012	M10-1.5 X 12	100	
CCC10014	M10-1.5 X 14	100	
CCC10016	M10-1.5 X 16	100	
CCC10018X	M10-1.5 X 18	100	
CCC10020	M10-1.5 X 20	100	
CCC10025	M10-1.5 X 25	100	
CCC10030	M10-1.5 X 30	50	
CCC10035	M10-1.5 X 35	50	
CCC10040	M10-1.5 X 40	50	
CCC10045	M10-1.5 X 45	50	
CCC10050	M10-1.5 X 50	50	

(continued...)

**SOCKET SET SCREW CUP POINT (cont.)**

DIN 916 - PLAIN FINISH

Line: 1655-00

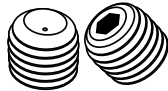

PART NUMBER	SIZE	QTY/BX	LIST PRICE
CCC10055	M10-1.5 X 55	25	
CCC10060	M10-1.5 X 60	50	
CCC12012	M12-1.75 X 12	50	
CCC12014X	M12-1.75 X 14	50	
CCC12016	M12-1.75 X 16	50	
CCC12018X	M12-1.75 X 18	50	
CCC12020	M12-1.75 X 20	50	
CCC12025	M12-1.75 X 25	50	
CCC12030	M12-1.75 X 30	50	
CCC12035	M12-1.75 X 35	50	
CCC12040	M12-1.75 X 40	50	
CCC12045	M12-1.75 X 45	25	
CCC12050	M12-1.75 X 50	25	
CCC12055	M12-1.75 X 55	25	
CCC12060	M12-1.75 X 60	25	
CCC12070	M12-1.75 X 70	25	
CCC12080	M12-1.75 X 80	25	
CCC14014X	M14-2.0 X 14	25	
CCC14016X	M14-2.0 X 16	25	
CCC14020X	M14-2.0 X 20	25	
CCC14025X	M14-2.0 X 25	25	
CCC14030X	M14-2.0 X 30	25	
CCC14040X	M14-2.0 X 40	25	
CCC14050X	M14-2.0 X 50	25	
CCC16016	M16-2.0 X 16	25	
CCC16018X	M16-2.0 X 18	25	
CCC16020	M16-2.0 X 20	25	
CCC16025	M16-2.0 X 25	25	
CCC16030	M16-2.0 X 30	25	
CCC16035	M16-2.0 X 35	25	
CCC16040	M16-2.0 X 40	25	
CCC16045	M16-2.0 X 45	25	
CCC16050	M16-2.0 X 50	25	
CCC16055	M16-2.0 X 55	25	
CCC16060	M16-2.0 X 60	25	
CCC16070	M16-2.0 X 70	10	
CCC16080	M16-2.0 X 80	10	
CCC20020	M20-2.5 X 20	10	
CCC20025	M20-2.5 X 25	10	

(continued...)

**SOCKET SET SCREW CUP POINT (cont.)**

DIN 916 - PLAIN FINISH

Line: 1655-00

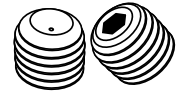

PART NUMBER	SIZE	QTY/BX	LIST PRICE
CCC20030	M20-2.5 X 30	10	
CCC20035	M20-2.5 X 35	10	
CCC20040	M20-2.5 X 40	10	
CCC20045	M20-2.5 X 45	10	
CCC20050	M20-2.5 X 50	10	
CCC20055	M20-2.5 X 55	10	
CCC20060	M20-2.5 X 60	10	
CCC20070	M20-2.5 X 70	10	
CCC20080	M20-2.5 X 80	10	
CCC24025	M24-3.0 X 25	10	
CCC24030	M24-3.0 X 30	10	
CCC24035	M24-3.0 X 35	10	
CCC24040	M24-3.0 X 40	10	
CCC24045	M24-3.0 X 45	10	
CCC24050	M24-3.0 X 50	10	
CCC24055	M24-3.0 X 55	10	
CCC24060	M24-3.0 X 60	10	
CCC24070	M24-3.0 X 70	10	
CCC24080	M24-3.0 X 80	10	

**BUTTON SOCKET CAP SCREW**

ISO #7380 - PLAIN FINISH

Line: 1656-00

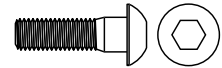

PART NUMBER	SIZE	QTY/BX	LIST PRICE
BMJ02008	M2-.4 X 8	100	
BMJ02012	M2-.4 X 12	100	
BMJ02016	M2-.4 X 16	100	
BMJ02020	M2-.4 X 20	100	
BMJ03006	M3-.5 X 6	100	
BMJ03008	M3-.5 X 8	100	
BMJ03010	M3-.5 X 10	100	
BMJ04008	M4-0.7 X 8	100	
BMJ04010	M4-0.7 X 10	100	
BMJ04012	M4-0.7 X 12	100	
BMJ04016	M4-0.7 X 16	100	
BMJ04020	M4-.7 X 20	100	
BMJ04025	M4-.7 X 25	100	
BMJ04035	M4-.7 X 35	100	
BMJ05008	M5-.8 X 8	100	
BMJ05010	M5-0.8 X 10	100	

(continued...)

**BUTTON SOCKET CAP SCREW (cont.)**

ISO #7380 - PLAIN FINISH

Line: 1656-00

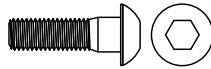

PART NUMBER	SIZE	QTY/BX	LIST PRICE
BMJ05012	M5-0.8 X 12	100	
BMJ05016	M5-0.8 X 16	100	
BMJ05020	M5-0.8 X 20	100	
BMJ05025	M5-0.8 X 25	100	
BMJ05030	M5-.8 X 30	100	
BMJ05040	M5-.8 X 40	100	
BMJ05045	M5-.8 X 45	100	
BMJ06008	M6-1.0 X 8	100	
BMJ06010	M6-1.0 X 10	100	
BMJ06012	M6-1.0 X 12	100	
BMJ06016	M6-1.0 X 16	100	
BMJ06020	M6-1.0 X 20	100	
BMJ06025	M6-1.0 X 25	100	
BMJ06030	M6-1.0 X 30	100	
BMJ06035	M6-1.0 X 35	100	
BMJ06040	M6-1.0 X 40	100	
BMJ06050	M6-1.0 X 50	100	
BMJ08010	M8-1.25 X 10	50	
BMJ08012	M8-1.25 X 12	50	
BMJ08016	M8-1.25 X 16	50	
BMJ08020	M8-1.25 X 20	50	
BMJ08025	M8-1.25 X 25	50	
BMJ08030	M8-1.25 X 30	50	
BMJ08035	M8-1.25 X 35	50	
BMJ08040	M8-1.25 X 40	50	
BMJ08045	M8-1.25 X 45	50	
BMJ08050	M8-1.25 X 50	50	
BMJ10012	M10-1.50 X 12	100	
BMJ10016	M10-1.50 X 16	50	
BMJ10020	M10-1.50 X 20	50	
BMJ10025	M10-1.50 X 25	50	
BMJ10030	M10-1.50 X 30	50	
BMJ10035	M10-1.50 X 35	50	
BMJ10040	M10-1.50 X 40	50	
BMJ10045	M10-1.50 X 45	50	
BMJ10050	M10-1.50 X 50	50	
BMJ12035	M12-1.75 X 35	50	
BMJ12040	M12-1.75 X 40	50	

**LOW HEAD SOCKET CAP SCREW**

DIN 7984 - PLAIN FINISH

Line: 1657-00

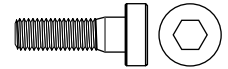

PART NUMBER	SIZE	QTY/BX	LIST PRICE
CEC04016	M4-.7 X 16	100	
CEC04020	M4-.7 X 20	100	
CEC05025	M5-.8 X 25	100	
CEC06010	M6-1.0 X 10	100	
CEC060107984	M6-1.0 X 10 DIN7984	100	
CEC06012	M6-1.0 X 12	100	
CEC06016	M6-1.0 X 16	100	
CEC06020	M6-1.0 X 20	100	
CEC06025	M6-1.0 X 25	100	
CEC06030	M6-1.0 X 30	50	
CEC06045	M6-1.0 X 45	100	
CEC08010	M8-1.25 X 10	50	
CEC08012	M8-1.25 X 12	50	
CEC08016	M8-1.25 X 16	50	
CEC08020	M8-1.25 X 20	50	
CEC08025	M8-1.25 X 25	50	
CEC08030	M8-1.25 X 30	50	
CEC08035	M8-1.25 X 35	25	
CEC08040	M8-1.25 X 40	25	
CEC08050	M8-1.25 X 50	25	
CEC08060	M8-1.25 X 60	25	
CEC10016	M10-1.5 X 16	50	
CEC10020	M10-1.5 X 20	50	
CEC10025	M10-1.5 X 25	50	
CEC10030	M10-1.5 X 30	50	
CEC10035	M10-1.5 X 35	25	
CEC10040	M10-1.5 X 40	25	
CEC10050	M10-1.5 X 50	25	
CEC10060	M10-1.5 X 60	25	
CEC10070	M10-1.5 X 70	50	
CEC12020	M12-1.75X 20	50	
CEC12025	M12-1.75 X 25	50	
CEC12030	M12-1.75X 30	50	
CEC12040	M12-1.75X 40	50	
CEC12050	M12-1.75X 50	50	
CEC12060	M12-1.75X 60	50	
CEC16030	M16-2.0 X 30	25	
CEC16035	M16-2.0 X 35	25	
CEC16040	M16-2.0 X 40	25	

(continued...)

**LOW HEAD SOCKET CAP SCREW (cont.)**

DIN 7984 - PLAIN FINISH

Line: 1657-00

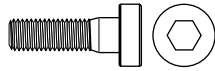

PART NUMBER	SIZE	QTY/BX	LIST PRICE
<b>CEC16045</b>	M16-2.0 X 45	25	
<b>CEC16050</b>	M16-2.0 X 50	25	
<b>CEC16060</b>	M16-2.0 X 60	25	
<b>CEC240607984</b>	M24-3.0 X 60 DN7984	10	

**SOCKET SHOULDER SCREW**

12.9 ISO #7379 - PLAIN FINISH

Line: 1657-01

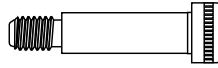

PART NUMBER	SIZE	QTY/BX	LIST PRICE
<b>BMK06010</b>	M6 X 10	25	
<b>BMK06012</b>	M6 X 12	25	
<b>BMK06016</b>	M6 X 16	25	
<b>BMK06020</b>	M6 X 20	25	
<b>BMK06025</b>	M6 X 25	25	
<b>BMK06030</b>	M6 X 30	25	
<b>BMK06040</b>	M6 X 40	25	
<b>BMK06050</b>	M6 X 50	25	
<b>BMK08012</b>	M8 X 12	25	
<b>BMK08016</b>	M8 X 16	25	
<b>BMK08020</b>	M8 X 20	25	
<b>BMK08025</b>	M8 X 25	25	
<b>BMK08030</b>	M8 X 30	25	
<b>BMK08040</b>	M8 X 40	25	
<b>BMK08050</b>	M8 X 50	25	
<b>BMK08060</b>	M8 X 60	25	
<b>BMK08070</b>	M8 X 70	25	
<b>BMK10016</b>	M10 X 16	25	
<b>BMK10020</b>	M10 X 20	25	
<b>BMK10025</b>	M10 X 25	25	
<b>BMK10030</b>	M10 X 30	25	
<b>BMK10040</b>	M10 X 40	25	
<b>BMK10050</b>	M10 X 50	25	
<b>BMK10055</b>	M10 X 55	25	
<b>BMK10060</b>	M10 X 60	25	
<b>BMK10070</b>	M10 X 70	25	
<b>BMK10080</b>	M10 X 80	25	
<b>BMK12016</b>	M12 X 16	25	
<b>BMK12020</b>	M12 X 20	25	
<b>BMK12025</b>	M12 X 25	25	
<b>BMK12030</b>	M12 X 30	25	
<b>BMK12040</b>	M12 X 40	25	

(continued...)

**SOCKET SHOULDER SCREW (cont.)**

12.9 ISO #7379 - PLAIN FINISH

Line: 1657-01

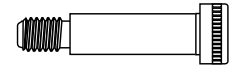

PART NUMBER	SIZE	QTY/BX	LIST PRICE
<b>BMK12050</b>	M12 X 50	25	
<b>BMK12060</b>	M12 X 60	25	
<b>BMK12070</b>	M12 X 70	25	
<b>BMK12080</b>	M12 X 80	25	
<b>BMK12090</b>	M12 X 90	25	
<b>BMK12100</b>	M12 X 100	25	
<b>BMK16030</b>	M16 X 30	25	
<b>BMK16040</b>	M16 X 40	25	
<b>BMK16050</b>	M16 X 50	25	
<b>BMK16060</b>	M16 X 60	25	
<b>BMK16070</b>	M16 X 70	25	
<b>BMK16080</b>	M16 X 80	25	
<b>BMK16090</b>	M16 X 90	25	
<b>BMK16100</b>	M16 X 100	25	
<b>BMK16120</b>	M16 X 120	25	
<b>BMK20040</b>	M20 X 40	25	
<b>BMK20050</b>	M20 X 50	25	
<b>BMK20060</b>	M20 X 60	10	
<b>BMK20070</b>	M20 X 70	10	
<b>BMK20080</b>	M20 X 80	10	
<b>BMK20090</b>	M20 X 90	10	
<b>BMK20100</b>	M20 X 100	10	
<b>BMK20120</b>	M20 X 120	10	



**CALL - 1 (800) 723-2826**

**CALL: (800) 723-2826**



## HARDENED PULL DOWEL PINS

DIN 7979D

Line: 1657-02



PART NUMBER	SIZE	QTY/BX	LIST PRICE
CFN06016P	M6 X 16 PULL 7979D	50	
CFN06020P	M6 X 20 PULL 7979D	50	
CFN06024P	M6 X 24 PULL 7979D	50	
CFN08016P	M8 X 16 PULL 7979D	25	
CFN08020P	M8 X 20 PULL 7979D	50	
CFN08024P	M8 X 24 PULL 7979D	50	
CFN08030P	M8 X 30 PULL 7979D	25	
CFN08032P	M8 X 32 PULL 7979D	25	
CFN08036P	M8 X 36 PULL 7979D	25	
CFN08040P	M8 X 40 PULL 7979D	25	
CFN08050P	M8 X 50 PULL 7979D	10	
CFN10020P	M10 X 20 PULL 7979D	25	
CFN10024P	M10 X 24 PULL 7979D	25	
CFN10032P	M10 X 32 PULL 7979D	25	
CFN10036P	M10 X 36 PULL 7979D	10	
CFN10040P	M10 X 40 PULL 7979D	10	
CFN10050P	M10 X 50 PULL 7979D	10	

## THREADED ROD GRADE 4.6

DIN 975 - ZINC PLATED

Line: 1660-00



PART NUMBER	SIZE	QTY/BX	LIST PRICE
BTC03-1	M3-.5 X 1 METER	1	
BTC04-1	M4-.7 X 1 METER	1	
BTC05-1	M5-.8 X 1 METER	1	
BTC06-1	M6-1.0 X 1 METER	1	
BTC07-1	M7-1.0 X 1 METER	1	
BTC08-1	M8-1.25 X 1 METER	1	
BTC10-1	M10-1.5 X 1 METER	1	
BTC10F-1	M10-1.25 X 1 METER (P/F, FINE THD)	1	
BTC12-1	M12-1.75X 1 METER	1	
BTC12EF-1	M12-1.25 X 1 METER (EXTRA FINE)	1	
BTC14-1	M14-2.0 X 1 METER	1	
BTC16-1	M16-2.0 X 1 METER	1	
BTC16F-1	M16-1.5 X 1 METER (FINE THREAD)	1	
BTC20-1	M20-2.5 X 1 METER	1	
BTC24-1	M24-3.0 X 1 METER	1	

## THREADED ROD

304 (A2) STAINLESS STEEL

Line: 1660-01



PART NUMBER	SIZE	QTY/BX	LIST PRICE
BTN04-1	M4-0.7 X 1 METER	1	
BTN05-1	M5-0.8 X 1 METER	1	
BTN06-1	M6-1.0 X 1 METER	1	
BTN08-1	M8-1.25 X 1 METER	1	
BTN10-1	M10-1.5 X 1 METER	1	
BTN12-1	M12-1.75 X 1 METER	1	
BTN14-1	M14-2.0 X 1 METER	1	
BTN16-1	M16-2.0 X 1 METER	1	
BTN20-1	M20-2.5 X 1 METER	1	
BTN24-1	M24-3.0 X 1 METER	1	

## THREADED ROD - B7 ALLOY - PLAIN FINISH

DIN 975/ASTM-A193-B7

Line: 1660-02



PART NUMBER	SIZE	QTY/BX	LIST PRICE
BTP06-1	M6-1.0 X 1 METER	1	
BTP08-1	M8-1.25 X 1 METER	1	
BTP10-1	M10-1.5 X 1 METER	1	
BTP12-1	M12-1.75 X 1 METER	1	
BTP14-1	M14-2.0 X 1 METER	1	
BTP16F-1	M16-1.5 X 1 METER FINE	1	
BTP16-1	M16-2.0 X 1 METER	1	
BTP18-1	M18-2.5 X 1 METER	1	
BTP20-1	M20-2.5 X 1 METER	1	
BTP24-1	M24-3.0 X 1 METER	1	
BTP30-1	M30-3.5 X 1 METER	1	

**COTTER PINS**

DIN 94 - ZINC PLATED

Line: 1661-00

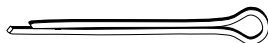

PART NUMBER	SIZE	QTY/BX	LIST PRICE
BZC1.6010	M1.6 X 10	100	
BZC1.6012	M1.6 X 12	100	
BZC1.6016	M1.6 X 16	100	
BZC1.6018	M1.6 X 18	100	
BZC1.6020	M1.6 X 20	100	
BZC1.6025	M1.6 X 25	100	
BZC1.6032	M1.6 X 32	100	
BZC1.6036	M1.6 X 36	100	
BZC02016	M2 X 16	100	
BZC02018	M2 X 18	100	
BZC02020	M2 X 20	100	
BZC02022	M2 X 22	100	
BZC02025	M2 X 25	100	
BZC02032	M2 X 32	100	
BZC02040	M2 X 40	100	
BZC2.5016	M2.5 X 16	100	
BZC2.5020	M2.5 X 20	100	
BZC2.5025	M2.5 X 25	100	
BZC2.5032	M2.5 X 32	100	
BZC2.5040	M2.5 X 40	100	
BZC03025	M3 X 25	100	
BZC3.2016	M3.2 X 16	100	
BZC3.2020	M3.2 X 20	100	
BZC3.2025	M3.2 X 25	100	
BZC3.2032	M3.2 X 32	100	
BZC3.2040	M3.2 X 40	100	
BZC3.2050	M3.2 X 50	100	
BZC04025	M4 X 25	100	
BZC04032	M4 X 32	100	
BZC04040	M4 X 40	100	
BZC04045	M4 X 45	100	
BZC04050	M4 X 50	100	
BZC04063	M4 X 63	100	
BZC05020X	M5 X 20	100	
BZC05032	M5 X 32	100	
BZC05040	M5 X 40	100	
BZC05045	M5 X 45	100	
BZC05050	M5 X 50	100	
BZC05056	M5 X 56	100	
BZC05063	M5 X 63	100	

(continued...)

**COTTER PINS (cont.)**

DIN 94 - ZINC PLATED

Line: 1661-00

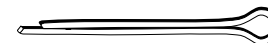

PART NUMBER	SIZE	QTY/BX	LIST PRICE
BZC05071	M5 X 71	100	
BZC6.3040	M6.3 X 40	100	
BZC6.3045	M6.3 X 45	100	
BZC6.3050	M6.3 X 50	100	
BZC6.3063	M6.3 X 63	100	
BZC6.3080	M6.3 X 80	100	

**SLOT CHEESE HEAD MACH. SCREW**

DIN 84 - ZINC PLATED

Line: 1662-00

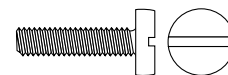

PART NUMBER	SIZE	QTY/BX	LIST PRICE
CGC02010	M2-.4 X 10	100	
CGC02012	M2-.4 X 12	100	
CGC02016	M2-.4 X 16	100	
CGC02020	M2-.4 X 20	100	
CGC02004	M2-.4 X 4	100	
CGC02006	M2-.4 X 6	100	
CGC02008	M2-.4 X 8	100	
CGC25010	M2.5-.45 X 10	100	
CGC25016	M2.5-.45 X 16	100	
CGC03010	M3-.5 X 10	100	
CGC03012	M3-.5 X 12	100	
CGC03014	M3-.5 X 14	100	
CGC03016	M3-.5 X 16	100	
CGC03018	M3-.5 X 18	100	
CGC03020	M3-.5 X 20	100	
CGC03022	M3-.5 X 22	100	
CGC03025	M3-.5 X 25	100	
CGC03035	M3-.5 X 35	100	
CGC03004	M3-.5 X 4	100	
CGC03045	M3-.5 X 45	100	
CGC03005	M3-.5 X 5	100	
CGC03050	M3-.5 X 50	100	
CGC03006	M3-.5 X 6	100	
CGC03008	M3-.5 X 8	100	
CGC35012	M3.5-.6 X 12	100	
CGC04010	M4-.7 X 10	100	
CGC04012	M4-.7 X 12	100	
CGC04016	M4-.7 X 16	100	
CGC04018	M4-.7 X 18	100	
CGC04020	M4-.7 X 20	100	

(continued...)

**CALL: (800) 723-2826**

**SLOT CHEESE HEAD MACH. SCREW (cont.)**

DIN 84 - ZINC PLATED

Line: 1662-00

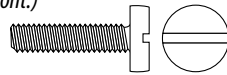

PART NUMBER	SIZE	QTY/BX	LIST PRICE
CGC04022	M4-.7 X 22	100	
CGC04025	M4-.7 X 25	100	
CGC04030	M4-.7 X 30	100	
CGC04035	M4-.7 X 35	100	
CGC04004	M4-.7 X 4	100	
CGC04040	M4-.7 X 40	100	
CGC04045	M4-.7 X 45	100	
CGC04005	M4-.7 X 5	100	
CGC04006	M4-.7 X 6	100	
CGC04008	M4-.7 X 8	100	
CGC05018	M5-.7 X 18	100	
CGC05010	M5-.8 X 10	100	
CGC05012	M5-.8 X 12	100	
CGC05014	M5-.8 X 14	100	
CGC05016	M5-.8 X 16	100	
CGC05020	M5-.8 X 20	100	
CGC05025	M5-.8 X 25	100	
CGC05030	M5-.8 X 30	100	
CGC05035	M5-.8 X 35	100	
CGC05040	M5-.8 X 40	100	
CGC05045	M5-.8 X 45	100	
CGC05005	M5-.8 X 5	100	
CGC05006	M5-.8 X 6	100	
CGC05008	M5-.8 X 8	100	
CGC06045	M6-.8 X 45	100	
CGC06010	M6-1.0 X 10	100	
CGC06012	M6-1.0 X 12	100	
CGC06016	M6-1.0 X 16	100	
CGC06020	M6-1.0 X 20	100	
CGC06025	M6-1.0 X 25	100	
CGC06030	M6-1.0 X 30	100	
CGC06035	M6-1.0 X 35	100	
CGC06040	M6-1.0 X 40	100	
CGC06050	M6-1.0 X 50	100	
CGC06055	M6-1.0 X 55	100	
CGC06060	M6-1.0 X 60	100	
CGC06008	M6-1.0 X 8	100	
CGC08010	M8-1.25 X 10	100	
CGC08012	M8-1.25 X 12	100	
CGC08016	M8-1.25 X 16	100	

(continued...)

**SLOT CHEESE HEAD MACH. SCREW (cont.)**

DIN 84 - ZINC PLATED

Line: 1662-00

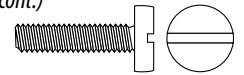

PART NUMBER	SIZE	QTY/BX	LIST PRICE
CGC08020	M8-1.25 X 20	100	
CGC08025	M8-1.25 X 25	100	
CGC08030	M8-1.25 X 30	100	
CGC08035	M8-1.25 X 35	100	
CGC08040	M8-1.25 X 40	100	
CGC08045	M8-1.25 X 45	100	
CGC08050	M8-1.25 X 50	50	
CGC08060	M8-1.25 X 60	50	
CGC10012	M10-1.5 X 12	100	
CGC10016	M10-1.5 X 16	100	
CGC10020	M10-1.5 X 20	100	
CGC10025	M10-1.5 X 25	100	
CGC10030	M10-1.5 X 30	50	
CGC10035	M10-1.5 X 35	50	
CGC10040	M10-1.5 X 40	50	
CGC10045	M10-1.5 X 45	50	
CGC10050	M10-1.5 X 50	50	
CGC10060	M10-1.5 X 60	50	

**SLOTTED FLAT HEAD MACHINE SCREW**

DIN 963A - ZINC PLATED

Line: 1662-01

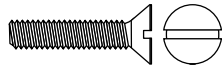

PART NUMBER	SIZE	QTY/BX	LIST PRICE
CHC02004	M2-.4 X 4	100	
CHC02005	M2-.4 X 5	100	
CHC02006	M2-.4 X 6	100	
CHC02008	M2-.4 X 8	100	
CHC02010	M2-.4 X 10	100	
CHC02012	M2-.4 X 12	100	
CHC03004	M3-.5 X 4	100	
CHC03005	M3-.5 X 5	100	
CHC03006	M3-.5 X 6	100	
CHC03008	M3-.5 X 8	100	
CHC03010	M3-.5 X 10	100	
CHC03012	M3-.5 X 12	100	
CHC03014	M3-.5 X 14	100	
CHC03016	M3-.5 X 16	100	
CHC03018	M3-.5 X 18	100	
CHC03020	M3-.5 X 20	100	
CHC03025	M3-.5 X 25	100	
CHC03030	M3-.5 X 30	100	
CHC04005	M4-.7 X 5	100	
CHC04006	M4-.7 X 6	100	
CHC04008	M4-.7 X 8	100	
CHC04010	M4-.7 X 10	100	
CHC04012	M4-.7 X 12	100	
CHC04014	M4-.7 X 14	100	
CHC04016	M4-.7 X 16	100	
CHC04020	M4-.7 X 20	100	
CHC04025	M4-.7 X 25	100	
CHC04030	M4-.7 X 30	100	
CHC04035	M4-.7 X 35	100	
CHC04040	M4-.7 X 40	100	
CHC05006	M5-.8 X 6	100	
CHC05008	M5-.8 X 8	100	
CHC05010	M5-.8 X 10	100	
CHC05012	M5-.8 X 12	100	
CHC05016	M5-.8 X 16	100	
CHC05020	M5-.8 X 20	100	
CHC05025	M5-.8 X 25	100	
CHC05030	M5-.8 X 30	100	
CHC05035	M5-.8 X 35	100	

(continued...)

**SLOTTED FLAT HEAD MACHINE SCREW (cont.)**

DIN 963A - ZINC PLATED

Line: 1662-01

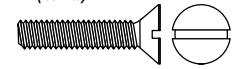

PART NUMBER	SIZE	QTY/BX	LIST PRICE
CHC05040	M5-.8 X 40	100	
CHC05050	M5-.8 X 50	100	
CHC06008	M6-1.0 X 8	100	
CHC06010	M6-1.0 X 10	100	
CHC06012	M6-1.0 X 12	100	
CHC06014	M6-1.0 X 14	100	
CHC06016	M6-1.0 X 16	100	
CHC06020	M6-1.0 X 20	100	
CHC06025	M6-1.0 X 25	100	
CHC06030	M6-1.0 X 30	100	
CHC06035	M6-1.0 X 35	100	
CHC06040	M6-1.0 X 40	100	
CHC06050	M6-1.0 X 50	100	
CHC08010	M8-1.25 X 10	100	
CHC08012	M8-1.25 X 12	100	
CHC08016	M8-1.25 X 16	100	
CHC08020	M8-1.25 X 20	100	
CHC08025	M8-1.25 X 25	100	
CHC08030	M8-1.25 X 30	100	
CHC08035	M8-1.25 X 35	100	
CHC08040	M8-1.25 X 40	100	
CHC08045	M8-1.25 X 45	100	
CHC08050	M8-1.25 X 50	50	
CHC08060	M8-1.25 X 60	50	
CHC10016	M10-1.5 X 16	100	
CHC10020	M10-1.5 X 20	100	
CHC10025	M10-1.5 X 25	100	
CHC10030	M10-1.5 X 30	50	
CHC10035	M10-1.5 X 35	50	
CHC10040	M10-1.5 X 40	50	
CHC10045	M10-1.5 X 45	50	
CHC10050	M10-1.5 X 50	50	
CHC10060	M10-1.5 X 60	50	

## SLOTTED PAN HEAD MACHINE SCREW

DIN 85A - ZINC PLATED

Line: 1663-00

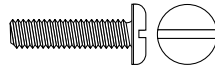

PART NUMBER	SIZE	QTY/BX	LIST PRICE
CJC25006	M2.5-.45 X 6	100	
CJC25008	M2.5-.45 X 8	100	
CJC25010	M2.5-.45 X 10	100	
CJC25012	M2.5-.45 X 12	100	
CJC25025	M2.5-.45 X 25	100	
CJC03004	M3-.5 X 4	100	
CJC03005	M3-.5 X 5	100	
CJC03006	M3-.5 X 6	100	
CJC03008	M3-.5 X 8	100	
CJC03010	M3-.5 X 10	100	
CJC03012	M3-.5 X 12	100	
CJC03016	M3-.5 X 16	100	
CJC03020	M3-.5 X 20	100	
CJC03025	M3-.5 X 25	100	
CJC03030	M3-.5 X 30	100	
CJC035005	M3.5-.6 X 5	100	
CJC04004	M4-.7 X 4	100	
CJC04005	M4-.7 X 5	100	
CJC04006	M4-.7 X 6	100	
CJC04008	M4-.7 X 8	100	
CJC04010	M4-.7 X 10	100	
CJC04012	M4-.7 X 12	100	
CJC04016	M4-.7 X 16	100	
CJC04020	M4-.7 X 20	100	
CJC04025	M4-.7 X 25	100	
CJC04030	M4-.7 X 30	100	
CJC04040	M4-.7 X 40	100	
CJC04050	M4-.7 X 50	100	
CJC05006	M5-.8 X 6	100	
CJC05008	M5-.8 X 8	100	
CJC05010	M5-.8 X 10	100	
CJC05012	M5-.8 X 12	100	
CJC05014	M5-.8 X 14	100	
CJC05016	M5-.8 X 16	100	
CJC05020	M5-.8 X 20	100	
CJC05025	M5-.8 X 25	100	
CJC05030	M5-.8 X 30	100	
CJC05035	M5-.8 X 35	100	
CJC05040	M5-.8 X 40	100	

(continued...)

## SLOTTED PAN HEAD MACHINE SCREW (cont.)

DIN 85A - ZINC PLATED

Line: 1663-00

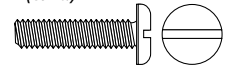

PART NUMBER	SIZE	QTY/BX	LIST PRICE
CJC05045	M5-.8 X 45	100	
CJC05050	M5-.8 X 50	100	
CJC06008	M6-1.0 X 8	100	
CJC06010	M6-1.0 X 10	100	
CJC06012	M6-1.0 X 12	100	
CJC06016	M6-1.0 X 16	100	
CJC06018	M6-1.0 X 18	100	
CJC06020	M6-1.0 X 20	100	
CJC06025	M6-1.0 X 25	100	
CJC06030	M6-1.0 X 30	100	
CJC06035	M6-1.0 X 35	100	
CJC06040	M6-1.0 X 40	100	
CJC06045	M6-1.0 X 45	100	
CJC06050	M6-1.0 X 50	100	
CJC06060	M6-1.0 X 60	100	
CJC08010	M8-1.25 X 10	100	
CJC08012	M8-1.25 X 12	100	
CJC08016	M8-1.25 X 16	100	
CJC08020	M8-1.25 X 20	100	
CJC08025	M8-1.25 X 25	100	
CJC08030	M8-1.25 X 30	100	
CJC08035	M8-1.25 X 35	100	
CJC08040	M8-1.25 X 40	100	
CJC08045	M8-1.25 X 45	100	
CJC08050	M8-1.25 X 50	50	
CJC08060	M8-1.25 X 60	50	
CJC08075	M8-1.25 X 75	50	
CJC08080	M8-1.25 X 80	50	
CJC10012	M10-1.5 X 12	100	
CJC10016	M10-1.5 X 16	100	
CJC10020	M10-1.5 X 20	100	
CJC10025	M10-1.5 X 25	100	
CJC10030	M10-1.5 X 30	50	
CJC10035	M10-1.5 X 35	50	
CJC10040	M10-1.5 X 40	50	
CJC10045	M10-1.5 X 45	50	
CJC10050	M10-1.5 X 50	50	
CJC10060	M10-1.5 X 60	50	

**SLOTTED OVAL HEAD MACHINE SCREW**

DIN 964 - ZINC PLATED

Line: 1664-00

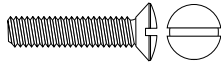

PART NUMBER	SIZE	QTY/BX	LIST PRICE
CKC03004	M3-.5 X 4	100	
CKC03005	M3-.5 X 5	100	
CKC03006	M3-.5 X 6	100	
CKC03008	M3-.5 X 8	100	
CKC03010	M3-.5 X 10	100	
CKC03012	M3-.5 X 12	100	
CKC03016	M3-.5 X 16	100	
CKC03020	M3-.5 X 20	100	
CKC03025	M3-.5 X 25	100	
CKC04006	M4-.7 X 6	100	
CKC04008	M4-.7 X 8	100	
CKC04010	M4-.7 X 10	100	
CKC04012	M4-.7 X 12	100	
CKC04016	M4-.7 X 16	100	
CKC04020	M4-.7 X 20	100	
CKC04025	M4-.7 X 25	100	
CKC04030	M4-.7 X 30	100	
CKC05006	M5-.8 X 6	100	
CKC05008	M5-.8 X 8	100	
CKC05010	M5-.8 X 10	100	
CKC05012	M5-.8 X 12	100	
CKC05016	M5-.8 X 16	100	
CKC05020	M5-.8 X 20	100	
CKC05025	M5-.8 X 25	100	
CKC05030	M5-.8 X 30	100	
CKC06010	M6-1.0 X 10	100	
CKC06012	M6-1.0 X 12	100	
CKC06016	M6-1.0 X 16	100	
CKC06020	M6-1.0 X 20	100	
CKC06025	M6-1.0 X 25	100	
CKC06030	M6-1.0 X 30	100	
CKC06035	M6-1.0 X 35	100	
CKC06040	M6-1.0 X 40	100	
CKC06045	M6-1.0 X 45	100	
CKC06050	M6-1.0 X 50	100	
CKC06060	M6-1.0 X 60	100	
CKC08016	M8-1.25 X 16	100	
CKC08020	M8-1.25 X 20	100	
CKC08025	M8-1.25 X 25	100	

(continued...)

**SLOTTED OVAL HEAD MACHINE SCREW (cont.)**

DIN 964 - ZINC PLATED

Line: 1664-00

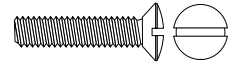

PART NUMBER	SIZE	QTY/BX	LIST PRICE
CKC08030	M8-1.25 X 30	100	
CKC08035	M8-1.25 X 35	100	
CKC08040	M8-1.25 X 40	100	
CKC08045	M8-1.25 X 45	100	
CKC08050	M8-1.25 X 50	50	
CKC08060	M8-1.25 X 60	50	
CKC10025	M10-1.5 X 25	100	
CKC10030	M10-1.5 X 30	50	
CKC10035	M10-1.5 X 35	50	
CKC10040	M10-1.5 X 40	50	
CKC10050	M10-1.5 X 50	50	

**PHILLIPS PAN HEAD MACHINE SCREW**

DIN 7985A - ZINC PLATED

Line: 1665-00

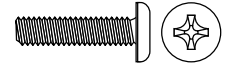

PART NUMBER	SIZE	QTY/BX	LIST PRICE
CNC02004	M2-.4 X 4	100	
CNC02006	M2-.4 X 6	100	
CNC02010	M2-.4 X 10	100	
CNC02012	M2-.4 X 12	100	
CNC02016	M2-.4 X 16	100	
CNC02020	M2-.4 X 20	100	
CNC25003	M2.5-.45 X 3	100	
CNC25006	M2.5-.45 X 6	100	
CNC25008	M2.5-.45 X 8	100	
CNC25010	M2.5-.45 X 10	100	
CNC25012	M2.5-.45 X 12	100	
CNC03004	M3-.5 X 4	100	
CNC03005	M3-.5 X 5	100	
CNC03006	M3-.5 X 6	100	
CNC03008	M3-.5 X 8	100	
CNC03010	M3-.5 X 10	100	
CNC03012	M3-.5 X 12	100	
CNC03016	M3-.5 X 16	100	
CNC03020	M3-.5 X 20	100	
CNC03025	M3-.5 X 25	100	
CNC03030	M3-.5 X 30	100	
CNC03045	M3-.5 X 45	100	
CNC04005	M4-.7 X 5	100	
CNC04006	M4-.7 X 6	100	

(continued...)

**PHILLIPS PAN HEAD MACHINE SCREW (cont.)**

DIN 7985A - ZINC PLATED

Line: 1665-00

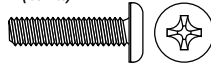

PART NUMBER	SIZE	QTY/BX	LIST PRICE
CNC04008	M4-.7 X 8	100	
CNC04010	M4-.7 X 10	100	
CNC04012	M4-.7 X 12	100	
CNC04016	M4-.7 X 16	100	
CNC04020	M4-.7 X 20	100	
CNC04025	M4-.7 X 25	100	
CNC04030	M4-.7 X 30	100	
CNC04040	M4-.7 X 40	100	
CNC04045	M4-.7 X 45	100	
CNC05006	M5-.8 X 6	100	
CNC05008	M5-.8 X 8	100	
CNC05010	M5-.8 X 10	100	
CNC05012	M5-.8 X 12	100	
CNC05014	M5-.8 X 14	100	
CNC05016	M5-.8 X 16	100	
CNC05020	M5-.8 X 20	100	
CNC05025	M5-.8 X 25	100	
CNC05030	M5-.8 X 30	100	
CNC05035	M5-.8 X 35	100	
CNC05040	M5-.8 X 40	100	
CNC05070	M5-.8 X 70	100	
CNC06008	M6-1.0 X 8	100	
CNC06010	M6-1.0 X 10	100	
CNC06012	M6-1.0 X 12	100	
CNC06014	M6-1.0 X 14	100	
CNC06016	M6-1.0 X 16	100	
CNC06020	M6-1.0 X 20	100	
CNC06025	M6-1.0 X 25	100	
CNC06030	M6-1.0 X 30	100	
CNC06035	M6-1.0 X 35	100	
CNC06040	M6-1.0 X 40	100	
CNC06045	M6-1.0 X 45	100	
CNC06050	M6-1.0 X 50	100	
CNC08010	M8-1.25 X 10	100	
CNC08016	M8-1.25 X 16	100	
CNC08020	M8-1.25 X 20	100	
CNC08025	M8-1.25 X 25	100	
CNC08030	M8-1.25 X 30	100	
CNC08035	M8-1.25 X 35	100	
CNC08040	M8-1.25 X 40	100	

(continued...)

**PHILLIPS PAN HEAD MACHINE SCREW (cont.)**

DIN 7985A - ZINC PLATED

Line: 1665-00

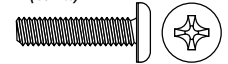

PART NUMBER	SIZE	QTY/BX	LIST PRICE
CNC08050	M8-1.25 X 50	50	
CNC10020	M10-1.5 X 20	100	
CNC10025	M10-1.5 X 25	100	
CNC10030	M10-1.5 X 30	50	
CNC10035	M10-1.5 X 35	100	
CNC10040	M10-1.5 X 40	50	

**PHILLIPS FLAT HEAD MACHINE SCREW**

DIN 965 - ZINC PLATED

Line: 1666-00

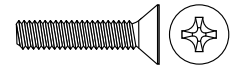

PART NUMBER	SIZE	QTY/BX	LIST PRICE
CMC02010	M2-.4 X 10	100	
CMC02016	M2-.4 X 16	100	
CMC02020	M2-.4 X 20	100	
CMC03004	M3-.5 X 4	100	
CMC03006	M3-.5 X 6	100	
CMC03008	M3-.5 X 8	100	
CMC03010	M3-.5 X 10	100	
CMC03012	M3-.5 X 12	100	
CMC03016	M3-.5 X 16	100	
CMC03020	M3-.5 X 20	100	
CMC03030	M3-.5 X 30	100	
CMC04006	M4-.7 X 6	100	
CMC04008	M4-.7 X 8	100	
CMC04010	M4-.7 X 10	100	
CMC04012	M4-.7 X 12	100	
CMC04016	M4-.7 X 16	100	
CMC04020	M4-.7 X 20	100	
CMC04025	M4-.7 X 25	100	
CMC05008	M5-.8 X 8	100	
CMC05010	M5-.8 X 10	100	
CMC05012	M5-.8 X 12	100	
CMC05016	M5-.8 X 16	100	
CMC05018	M5-.8 X 18	100	
CMC05020	M5-.8 X 20	100	
CMC05025	M5-.8 X 25	100	
CMC05030	M5-.8 X 30	100	
CMC06008	M6-1.0 X 8	100	
CMC06010	M6-1.0 X 10	100	
CMC06012	M6-1.0 X 12	100	
CMC06014	M6-1.0 X 14	100	

(continued...)

**PHILLIPS FLAT HEAD MACHINE SCREW (cont.)**

DIN 965 - ZINC PLATED

Line: 1666-00

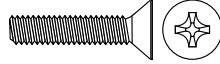

PART NUMBER	SIZE	QTY/BX	LIST PRICE
CMC06016	M6-1.0 X 16	100	
CMC06020	M6-1.0 X 20	100	
CMC06025	M6-1.0 X 25	100	
CMC06030	M6-1.0 X 30	100	
CMC06035	M6-1.0 X 35	100	
CMC06040	M6-1.0 X 40	100	
CMC06050	M6-1.0 X 50	100	
CMC08016	M8-1.25 X 16	100	
CMC08020	M8-1.25 X 20	100	
CMC08025	M8-1.25 X 25	100	
CMC08030	M8-1.25 X 30	100	
CMC08035	M8-1.25 X 35	100	
CMC08040	M8-1.25 X 40	100	
CMC10020	M10-1.5 X 20	100	
CMC10025	M10-1.5 X 25	100	
CMC10030	M10-1.5 X 30	50	
CMC10035	M10-1.5 X 35	100	
CMC10040	M10-1.5 X 40	50	
CMC10050	M10-1.5 X 50	50	

**PHILLIPS OVAL HEAD MACHINE SCREW**

DIN 966 - ZINC PLATED

Line: 1667-00

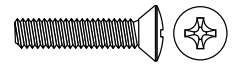

PART NUMBER	SIZE	QTY/BX	LIST PRICE
CLC25006	M2.5-.45 X 6	100	
CLC25010	M2.5-.45 X 10	100	
CLC03006	M3-.5 X 6	100	
CLC03008	M3-.5 X 8	100	
CLC03010	M3-.5 X 10	100	
CLC03012	M3-.5 X 12	100	
CLC03016	M3-.5 X 16	100	
CLC04006	M4-.7 X 6	100	
CLC04008	M4-.7 X 8	100	
CLC04010	M4-.7 X 10	100	
CLC04012	M4-.7 X 12	100	
CLC04016	M4-.7 X 16	100	
CLC04020	M4-.7 X 20	100	
CLC04025	M4-.7 X 25	100	
CLC04030	M4-.7 X 30	100	
CLC05010	M5-.8 X 10	100	
CLC05012	M5-.8 X 12	100	
CLC05016	M5-.8 X 16	100	
CLC05020	M5-.8 X 20	100	
CLC05025	M5-.8 X 25	100	
CLC05030	M5-.8 X 30	100	
CLC05040	M5-.8 X 40	100	
CLC06012	M6-1.0 X 12	100	
CLC06016	M6-1.0 X 16	100	
CLC06020	M6-1.0 X 20	100	
CLC06025	M6-1.0 X 25	100	
CLC06030	M6-1.0 X 30	100	
CLC06040	M6-1.0 X 40	100	
CLC08020	M8-1.25 X 20	100	
CLC08025	M8-1.25 X 25	100	
CLC08030	M8-1.25 X 30	100	
CLC08040	M8-1.25 X 40	100	
CLC10025	M10-1.5 X 25	100	
CLC10030	M10-1.5 X 30	50	



## HEX CAP SCREW DIN 931/933

A2 - 304 STAINLESS STEEL

Line: 1670-00

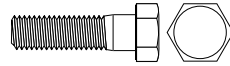

PART NUMBER	SIZE	QTY/BX	LIST PRICE
BSL03006	M3-.5 X 6	100	
BSL03008	M3-.5 X 8	100	
BSL03010	M3-.5 X 10	100	
BSL03012	M3-.5 X 12	100	
BSL03016	M3-.5 X 16	100	
BSL03020	M3-.5 X 20	100	
BSL03025	M3-.5 X 25	100	
BSL03030	M3-.5 X 30	100	
BSL04006	M4-.7 X 6	100	
BSL04008	M4-.7 X 8	100	
BSL04010	M4-.7 X 10	100	
BSL04012	M4-.7 X 12	100	
BSL04016	M4-.7 X 16	100	
BSL04020	M4-.7 X 20	100	
BSL04025	M4-.7 X 25	100	
BSL04030	M4-.7 X 30	100	
BSL04035	M4-.7 X 35	100	
BSL04040	M4-.7 X 40	100	
BSL04045	M4-.7 X 45	100	
BSL04050	M4-.7 X 50	100	
BSL04060	M4-.7 X 60	100	
BSL05008	M5-.8 X 8	100	
BSL05010	M5-.8 X 10	100	
BSL05012	M5-.8 X 12	100	
BSL05016	M5-.8 X 16	100	
BSL05020	M5-.8 X 20	100	
BSL05025	M5-.8 X 25	100	
BSL05030	M5-.8 X 30	100	
BSL05035	M5-.8 X 35	100	
BSL05040	M5-.8 X 40	100	
BSL05045	M5-.8 X 45	100	
BSL05050	M5-.8 X 50	100	
BSL05060	M5-.8 X 60	100	
BSL06008	M6-1.0 X 8	100	
BSL06010	M6-1.0 X 10	100	
BSL06012	M6-1.0 X 12	100	
BSL06016	M6-1.0 X 16	100	
BSL06020	M6-1.0 X 20	100	
BSL06025	M6-1.0 X 25	100	

(continued...)

## HEX CAP SCREW DIN 931/933 (cont.)

A2 - 304 STAINLESS STEEL

Line: 1670-00

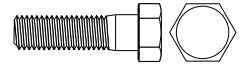

PART NUMBER	SIZE	QTY/BX	LIST PRICE
BSL06030	M6-1.0 X 30	100	
BSL06035	M6-1.0 X 35	100	
BSL06040	M6-1.0 X 40	100	
BSL06045	M6-1.0 X 45	100	
BSL06050	M6-1.0 X 50	100	
BSL06055	M6-1.0 X 55	100	
BSL06060	M6-1.0 X 60	100	
BSL06070	M6-1.0 X 70	100	
BSL06080	M6-1.0 X 80	50	
BSL06110	M6-1.0 X 110	50	
BSL08010	M8-1.25 X 10	100	
BSL08012	M8-1.25 X 12	100	
BSL08016	M8-1.25 X 16	100	
BSL08020	M8-1.25 X 20	100	
BSL08025	M8-1.25 X 25	100	
BSL08030	M8-1.25 X 30	100	
BSL08035	M8-1.25 X 35	100	
BSL08040	M8-1.25 X 40	100	
BSL08045	M8-1.25 X 45	100	
BSL08050	M8-1.25 X 50	50	
BSL08055	M8-1.25 X 55	50	
BSL08060	M8-1.25 X 60	50	
BSL08070	M8-1.25 X 70	50	
BSL08080	M8-1.25 X 80	50	
BSL08090	M8-1.25 X 90	50	
BSL08100	M8-1.25 X 100	50	
BSL08110	M8-1.25 X 110	50	
BSL10012	M10-1.5 X 12	100	
BSL10014	M10-1.5 X 14	100	
BSL10016	M10-1.5 X 16	100	
BSL10020	M10-1.5 X 20	100	
BSL10025	M10-1.5 X 25	100	
BSL10030	M10-1.5 X 30	100	
BSL10035	M10-1.5 X 35	100	
BSL10040	M10-1.5 X 40	50	
BSL10045	M10-1.5 X 45	50	
BSL10050	M10-1.5 X 50	50	
BSL10055	M10-1.5 X 55	50	
BSL10060	M10-1.5 X 60	50	

(continued...)

**HEX CAP SCREW DIN 931/933 (cont.)**

A2 - 304 STAINLESS STEEL

Line: 1670-00

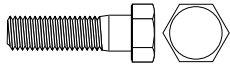

PART NUMBER	SIZE	QTY/BX	LIST PRICE
BSL10065	M10-1.5 X 65	50	
BSL10070	M10-1.5 X 70	50	
BSL10075	M10-1.5 X 75	25	
BSL10080	M10-1.5 X 80	25	
BSL10090	M10-1.5 X 90	25	
BSL10100	M10-1.5 X 100	25	
BSL10110	M10-1.5 X 110	25	
BSL10120	M10-1.5 X 120	25	
BSL10130	M10-1.5 X 130	25	
BSL12016	M12-1.75 X 16	50	
BSL12020	M12-1.75 X 20	50	
BSL12025	M12-1.75 X 25	50	
BSL12030	M12-1.75 X 30	50	
BSL12035	M12-1.75 X 35	50	
BSL12040	M12-1.75 X 40	50	
BSL12045	M12-1.75 X 45	50	
BSL12050	M12-1.75 X 50	50	
BSL12055	M12-1.75 X 55	50	
BSL12060	M12-1.75 X 60	50	
BSL12065	M12-1.75 X 65	50	
BSL12070	M12-1.75 X 70	50	
BSL12075	M12-1.75 X 75	25	
BSL12080	M12-1.75 X 80	25	
BSL12090	M12-1.75 X 90	25	
BSL12100	M12-1.75 X 100	25	
BSL12120	M12-1.75 X 120	25	
BSL12140	M12-1.75 X 140	25	
BSL14025	M14-2.0 X 25	25	
BSL14030	M14-2.0 X 30	25	
BSL14035	M14-2.0 X 35	25	
BSL14040	M14-2.0 X 40	25	
BSL14045	M14-2.0 X 45	25	
BSL14050	M14-2.0 X 50	25	
BSL14060	M14-2.0 X 60	25	
BSL14070	M14-2.0 X 70	25	
BSL14080	M14-2.0 X 80	15	
BSL16030	M16-2.0 X 30	25	
BSL16035	M16-2.0 X 35	25	
BSL16040	M16-2.0 X 40	25	

(continued...)

**HEX CAP SCREW DIN 931/933 (cont.)**

A2 - 304 STAINLESS STEEL

Line: 1670-00

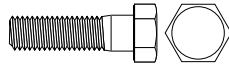

PART NUMBER	SIZE	QTY/BX	LIST PRICE
BSL16045	M16-2.0 X 45	25	
BSL16050	M16-2.0 X 50	25	
BSL16060	M16-2.0 X 60	25	
BSL16070	M16-2.0 X 70	25	
BSL16080	M16-2.0 X 80	10	
BSL16090	M16-2.0 X 90	10	
BSL16100	M16-2.0 X 100	10	
BSL16110	M16-2.0 X 110	10	
BSL16140	M16-2.0 X 140	10	
BSL20040	M20-2.5 X 40	25	
BSL20050	M20-2.5 X 50	25	
BSL20060	M20-2.5 X 60	10	
BSL20065	M20-2.5 X 65	10	
BSL20070	M20-2.5 X 70	10	
BSL20080	M20-2.5 X 80	10	
BSL20090	M20-2.5 X 90	10	
BSL20100	M20-2.5 X 100	10	
BSL20120	M20-2.5 X 120	10	
BSL24070	M24-3.0 X 70	10	
BSL24080	M24-3.0 X 80	10	
BSL24090	M24-3.0 X 90	10	
BSL24100	M24-3.0 X 100	10	
BSL24120	M24-3.0 X 120	10	
BSL24140	M24-3.0 X 140	10	



**CALL - 1 (800) 723-2826**

## FLAT WASHER DIN 125A

A2 - 304 STAINLESS STEEL

Line: 1670-04

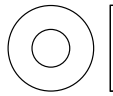

PART NUMBER	SIZE	QTY/BX	LIST PRICE
<b>BSM03</b>	M3	100	
<b>BSM04</b>	M4	100	
<b>BSM05</b>	M5	100	
<b>BSM06</b>	M6	100	
<b>BSM07</b>	M7	100	
<b>BSM08</b>	M8	100	
<b>BSM10</b>	M10	100	
<b>BSM12</b>	M12	100	
<b>BSM14</b>	M14	100	
<b>BSM16</b>	M16	100	
<b>BSM24</b>	M24 DIN125A	25	
<b>BSM30</b>	M30 DIN125A	25	

## SPLIT LOCK WASHER DIN 127B

A2 - 304 STAINLESS STEEL

Line: 1670-06

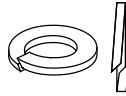

PART NUMBER	SIZE	QTY/BX	LIST PRICE
<b>BST02</b>	M2	100	
<b>BST03</b>	M3	100	
<b>BST04</b>	M4	100	
<b>BST05</b>	M5	100	
<b>BST06</b>	M6	100	
<b>BST06HC</b>	M6 HI-COLLAR	100	
<b>BST07</b>	M7	100	
<b>BST08</b>	M8	100	
<b>BST10</b>	M10	100	
<b>BST12</b>	M12	100	
<b>BST14</b>	M14	100	
<b>BST16</b>	M16	100	
<b>BST20</b>	M20	50	
<b>BST22</b>	M22	50	
<b>BST24</b>	M24	50	
<b>BST30</b>	M30	50	

## FINISHED HEX NUT DIN 934

A2 - 304 STAINLESS STEEL

Line: 1670-08

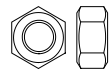

PART NUMBER	SIZE	QTY/BX	LIST PRICE
<b>BSN02</b>	M2-0.4	100	
<b>BSN025</b>	M2.5-.45	100	
<b>BSN03</b>	M3-0.5	100	
<b>BSN04</b>	M4-0.7	100	
<b>BSN05</b>	M5-0.8	100	
<b>BSN06</b>	M6-1.0	100	
<b>BSN07</b>	M7-1.0	100	
<b>BSN08</b>	M8-1.25	100	
<b>BSN10F</b>	M10-1.0 EXTRA FINE	100	
<b>BSN10</b>	M10-1.5	100	
<b>BSN12</b>	M12-1.75	100	
<b>BSN14</b>	M14-2.0	50	
<b>BSN16</b>	M16-2.0	50	
<b>BSN18</b>	M18-2.5	50	
<b>BSN20F</b>	M20-1.5 FINE	25	
<b>BSN20</b>	M20-2.5	25	
<b>BSN22</b>	M22-2.5	10	
<b>BSN24</b>	M24-3.0	10	
<b>BSN36A4</b>	M36-4.0 (A4)	10	

## WING NUT

A2 - 304 STAINLESS STEEL

Line: 1670-09

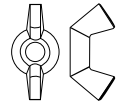

PART NUMBER	SIZE	QTY/BX	LIST PRICE
<b>BSV06</b>	M6-1.0	100	
<b>BSV08</b>	M8-1.25	100	
<b>BSV10</b>	M10-1.5	100	
<b>BSV12</b>	M12-1.75	100	

## SLOTTED PAN HEAD MACHINE SCREW

A2 - 304 STAINLESS STEEL - DIN 85A

Line: 1670-11

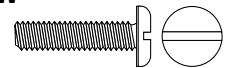

PART NUMBER	SIZE	QTY/BX	LIST PRICE
<b>CBW03006</b>	M3-.5 X 6	100	
<b>CBW06010</b>	M6-1.0 X 10	100	
<b>CBW06012</b>	M6-1.0 X 12	100	
<b>CBW06016</b>	M6-1.0 X 16	100	
<b>CBW06020</b>	M6-1.0 X 20	100	
<b>CBW06025</b>	M6-1.0 X 25	100	
<b>CBW06030</b>	M6-1.0 X 30	100	

**SLOTTED FLAT HEAD MACHINE SCREW**

A2 - 304 STAINLESS STEEL - DIN 963A

Line: 1670-12

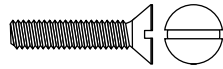

PART NUMBER	SIZE	QTY/BX	LIST PRICE
<b>CBX05010</b>	M5-0.8 X 10	100	
<b>CBX05080</b>	M5-0.8 X 80	100	
<b>CBX06030</b>	M6-1.0 X 30	100	

**PHILLIPS PAN HEAD MACHINE SCREW**

A2 - 304 STAINLESS STEEL - DIN 7985

Line: 1670-15

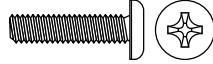

PART NUMBER	SIZE	QTY/BX	LIST PRICE
<b>BSP02004</b>	M2-0.4 X 4	100	
<b>BSP02005</b>	M2-0.4 X 5	100	
<b>BSP02006</b>	M2-0.4 X 6	100	
<b>BSP02008</b>	M2-0.4 X 8	100	
<b>BSP02010</b>	M2-0.4 X 10	100	
<b>BSP02012</b>	M2-0.4 X 12	100	
<b>BSP02016</b>	M2-0.4 X 16	100	
<b>BSP02020</b>	M2-0.4 X 20	100	
<b>BSP03004</b>	M3-0.5 X 4	100	
<b>BSP03005</b>	M3-0.5 X 5	100	
<b>BSP03006</b>	M3-0.5 X 6	100	
<b>BSP03008</b>	M3-0.5 X 8	100	
<b>BSP03010</b>	M3-0.5 X 10	100	
<b>BSP03012</b>	M3-0.5 X 12	100	
<b>BSP03016</b>	M3-0.5 X 16	100	
<b>BSP03020</b>	M3-0.5 X 20	100	
<b>BSP03025</b>	M3-0.5 X 25	100	
<b>BSP03030</b>	M3-0.5 X 30	100	
<b>BSP03035</b>	M3-0.5 X 35	100	
<b>BSP03040</b>	M3-0.5 X 40	100	
<b>BSP04005</b>	M4-0.7 X 5	100	
<b>BSP04006</b>	M4-0.7 X 6	100	
<b>BSP04008</b>	M4-0.7 X 8	100	
<b>BSP04010</b>	M4-0.7 X 10	100	
<b>BSP04012</b>	M4-0.7 X 12	100	
<b>BSP04016</b>	M4-0.7 X 16	100	
<b>BSP04020</b>	M4-0.7 X 20	100	
<b>BSP04025</b>	M4-0.7 X 25	100	
<b>BSP04030</b>	M4-0.7 X 30	100	
<b>BSP04035</b>	M4-0.7 X 35	100	
<b>BSP04040</b>	M4-0.7 X 40	100	
<b>BSP05006</b>	M5-0.8 X 6	100	
<b>BSP05008</b>	M5-0.8 X 8	100	

(continued...)

**PHILLIPS PAN HEAD MACHINE SCREW (cont.)**

A2 - 304 STAINLESS STEEL - DIN 7985

Line: 1670-15

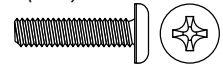

PART NUMBER	SIZE	QTY/BX	LIST PRICE
<b>BSP05010</b>	M5-0.8 X 10	100	
<b>BSP05012</b>	M5-0.8 X 12	100	
<b>BSP05016</b>	M5-0.8 X 16	100	
<b>BSP05020</b>	M5-0.8 X 20	100	
<b>BSP05025</b>	M5-0.8 X 25	100	
<b>BSP05030</b>	M5-0.8 X 30	100	
<b>BSP05035</b>	M5-0.8 X 35	100	
<b>BSP05040</b>	M5-0.8 X 40	100	
<b>BSP06008</b>	M6-1.0 X 8	100	
<b>BSP06010</b>	M6-1.0 X 10	100	
<b>BSP06012</b>	M6-1.0 X 12	100	
<b>BSP06016</b>	M6-1.0 X 16	100	
<b>BSP06020</b>	M6-1.0 X 20	100	
<b>BSP06025</b>	M6-1.0 X 25	100	
<b>BSP06030</b>	M6-1.0 X 30	100	
<b>BSP06035</b>	M6-1.0 X 35	100	
<b>BSP06040</b>	M6-1.0 X 40	100	
<b>BSP06045</b>	M6-1.0 X 45	100	
<b>BSP08016</b>	M8-1.25 X 16	100	
<b>BSP08020</b>	M8-1.25 X 20	100	
<b>BSP08025</b>	M8-1.25 X 25	100	
<b>BSP08030</b>	M8-1.25 X 30	100	
<b>BSP10025</b>	M10-1.5 X 25	100	
<b>BSP10030</b>	M10-1.5 X 30	50	
<b>BSP10040</b>	M10-1.5 X 40	50	

# PHILLIPS FLAT HEAD MACHINE SCREW

A2 - 304 STAINLESS STEEL - DIN 965A

Line: 1670-16

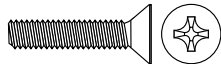

PART NUMBER	SIZE	QTY/BX	LIST PRICE
BSR02004	M2-0.4 X 4	100	
BSR02005	M2-0.4 X 5	100	
BSR02006	M2-0.4 X 6	100	
BSR02008	M2-0.4 X 8	100	
BSR02010	M2-0.4 X 10	100	
BSR02012	M2-0.4 X 12	100	
BSR02016	M2-0.4 X 16	100	
BSR02020	M2-0.4 X 20	100	
BSR03006	M3-0.5 X 6	100	
BSR03008	M3-0.5 X 8	100	
BSR03010	M3-0.5 X 10	100	
BSR03012	M3-0.5 X 12	100	
BSR03016	M3-0.5 X 16	100	
BSR03020	M3-0.5 X 20	100	
BSR03025	M3-0.5 X 25	100	
BSR03030	M3-0.5 X 30	100	
BSR04006	M4-0.7 X 6	100	
BSR04008	M4-0.7 X 8	100	
BSR04010	M4-0.7 X 10	100	
BSR04012	M4-0.7 X 12	100	
BSR04016	M4-0.7 X 16	100	
BSR04020	M4-0.7 X 20	100	
BSR04025	M4-0.7 X 25	100	
BSR04030	M4-0.7 X 30	100	
BSR04035	M4-0.7 X 35	100	
BSR04040	M4-0.7 X 40	100	
BSR05006	M5-0.8 X 6	100	
BSR05008	M5-0.8 X 8	100	
BSR05010	M5-0.8 X 10	100	
BSR05012	M5-0.8 X 12	100	
BSR05016	M5-0.8 X 16	100	
BSR05020	M5-0.8 X 20	100	
BSR05025	M5-0.8 X 25	100	
BSR05030	M5-0.8 X 30	100	
BSR05035	M5-0.8 X 35	100	
BSR05040	M5-0.8 X 40	100	
BSR06008	M6-1.0 X 8	100	
BSR06010	M6-1.0 X 10	100	
BSR06012	M6-1.0 X 12	100	
BSR06016	M6-1.0 X 16	100	

(continued...)

# PHILLIPS FLAT HEAD MACHINE SCREW (cont.)

A2 - 304 STAINLESS STEEL - DIN 965A

Line: 1670-16

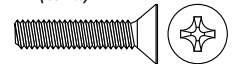

PART NUMBER	SIZE	QTY/BX	LIST PRICE
BSR06020	M6-1.0 X 20	100	
BSR06025	M6-1.0 X 25	100	
BSR06030	M6-1.0 X 30	100	
BSR06035	M6-1.0 X 35	100	
BSR06040	M6-1.0 X 40	100	
BSR08020	M8-1.25 X 20	100	
BSR08025	M8-1.25 X 25	100	
BSR08030	M8-1.25 X 30	100	
BSR08035	M8-1.25 X 35	100	
BSR10030	M10-1.5 X 30	50	
BSR10040	M10-1.5 X 40	50	

**PHILLIPS OVAL HEAD MACHINE SCREW**

A2 - 304 STAINLESS STEEL - DIN 966A

Line: 1670-17

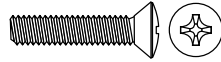

PART NUMBER	SIZE	QTY/BX	LIST PRICE
BTX03006	M3-0.5 X 6	100	
BTX03008	M3-0.5 X 8	100	
BTX03010	M3-0.5 X 10	100	
BTX03012	M3-0.5 X 12	100	
BTX03016	M3-0.5 X 16	100	
BTX03020	M3-0.5 X 20	100	
BTX03025	M3-0.5 X 25	100	
BTX03030	M3-0.5 X 30	100	
BTX03040	M3-0.5 X 40	100	
BTX04006	M4-0.7 X 6	100	
BTX04008	M4-0.7 X 8	100	
BTX04010	M4-0.7 X 10	100	
BTX04012	M4-0.7 X 12	100	
BTX04016	M4-0.7 X 16	100	
BTX04020	M4-0.7 X 20	100	
BTX04025	M4-0.7 X 25	100	
BTX04030	M4-0.7 X 30	100	
BTX04040	M4-0.7 X 40	100	
BTX05006	M5-0.8 X 6	100	
BTX05008	M5-0.8 X 8	100	
BTX05010	M5-0.8 X 10	100	
BTX05012	M5-0.8 X 12	100	
BTX05016	M5-0.8 X 16	100	
BTX05020	M5-0.8 X 20	100	
BTX05025	M5-0.8 X 25	100	
BTX05030	M5-0.8 X 30	100	
BTX05040	M5-0.8 X 40	100	
BTX06008	M6-1.0 X 8	100	
BTX06010	M6-1.0 X 10	100	
BTX06012	M6-1.0 X 12	100	
BTX06016	M6-1.0 X 16	100	
BTX06020	M6-1.0 X 20	100	
BTX06025	M6-1.0 X 25	100	
BTX06030	M6-1.0 X 30	100	
BTX06040	M6-1.0 X 40	100	

**SOCKET CAP SCREW - DIN 912**

A2 - 304 STAINLESS STEEL

Line: 1670-20

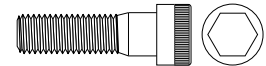

PART NUMBER	SIZE	QTY/BX	LIST PRICE
BSW03004	M3-0.5 X 4	100	
BSW03008	M3-0.5 X 8	100	
BSW03020	M3-0.5 X 20	100	
BSW04005	M4-0.7 X 5	100	
BSW04006	M4-0.7 X 6	100	
BSW04008	M4-0.7 X 8	100	
BSW04010	M4-0.7 X 10	100	
BSW04012	M4-0.7 X 12	100	
BSW04014	M4-0.7 X 14	100	
BSW04016	M4-0.7 X 16	100	
BSW04018	M4-0.7 X 18	100	
BSW04020	M4-0.7 X 20	100	
BSW04025	M4-0.7 X 25	100	
BSW04030	M4-0.7 X 30	100	
BSW04035	M4-0.7 X 35	100	
BSW04040	M4-0.7 X 40	100	
BSW04045	M4-0.7 X 45	100	
BSW04050	M4-0.7 X 50	100	
BSW05010	M5-0.8 X 10	100	
BSW05012	M5-0.8 X 12	100	
BSW05016	M5-0.8 X 16	100	
BSW05020	M5-0.8 X 20	100	
BSW05025	M5-0.8 X 25	100	
BSW05030	M5-0.8 X 30	100	
BSW05035	M5-0.8 X 35	100	
BSW05040	M5-0.8 X 40	100	
BSW05045	M5-0.8 X 45	100	
BSW05050	M5-0.8 X 50	100	
BSW05060	M5-0.8 X 60	100	
BSW05070	M5-0.8 X 70	100	
BSW05080	M5-0.8 X 80	100	
BSW06010	M6-1.0 X 10	100	
BSW06012	M6-1.0 X 12	100	
BSW06014	M6-1.0 X 14	100	
BSW06016	M6-1.0 X 16	100	
BSW06018	M6-1.0 X 18	100	
BSW06020	M6-1.0 X 20	100	
BSW06025	M6-1.0 X 25	100	
BSW06030	M6-1.0 X 30	100	

(continued...)

**SOCKET CAP SCREW - DIN 912 (cont.)**

A2 - 304 STAINLESS STEEL

Line: 1670-20

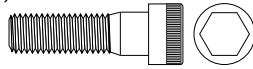

PART NUMBER	SIZE	QTY/BX	LIST PRICE
BSW06035	M6-1.0 X 35	100	
BSW06040	M6-1.0 X 40	100	
BSW06045	M6-1.0 X 45	100	
BSW06050	M6-1.0 X 50	100	
BSW06060	M6-1.0 X 60	100	
BSW06070	M6-1.0 X 70	50	
BSW06075	M6-1.0 X 75	50	
BSW06080	M6-1.0 X 80	50	
BSW06090	M6-1.0 X 90	50	
BSW06100	M6-1.0 X 100	50	
BSW08010	M8-1.25 X 10	50	
BSW08012	M8-1.25 X 12	50	
BSW08014	M8-1.25 X 14	50	
BSW08016	M8-1.25 X 16	50	
BSW08018	M8-1.25 X 18	50	
BSW08020	M8-1.25 X 20	50	
BSW08025	M8-1.25 X 25	50	
BSW08030	M8-1.25 X 30	50	
BSW08035	M8-1.25 X 35	50	
BSW08040	M8-1.25 X 40	50	
BSW08045	M8-1.25 X 45	50	
BSW08050	M8-1.25 X 50	50	
BSW08055	M8-1.25 X 55	50	
BSW08060	M8-1.25 X 60	50	
BSW08070	M8-1.25 X 70	50	
BSW08080	M8-1.25 X 80	50	
BSW08090	M8-1.25 X 90	50	
BSW08100	M8-1.25 X 100	50	
BSW08120	M8-1.25 X 120	25	
BSW08140	M8-1.25 X 140	25	
BSW08150	M8-1.25 X 150	25	
BSW10016	M10-1.5 X 16	50	
BSW10020	M10-1.5 X 20	50	
BSW10025	M10-1.5 X 25	25	
BSW10030	M10-1.5 X 30	25	
BSW10035	M10-1.5 X 35	25	
BSW10040	M10-1.5 X 40	25	
BSW10045	M10-1.5 X 45	25	
BSW10050	M10-1.5 X 50	25	

(continued...)

**SOCKET CAP SCREW - DIN 912 (cont.)**

A2 - 304 STAINLESS STEEL

Line: 1670-20

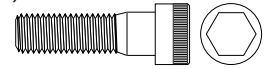

PART NUMBER	SIZE	QTY/BX	LIST PRICE
BSW10055	M10-1.5 X 55	25	
BSW10060	M10-1.5 X 60	25	
BSW10070	M10-1.5 X 70	25	
BSW10080	M10-1.5 X 80	25	
BSW10090	M10-1.5 X 90	25	
BSW10100	M10-1.5 X 100	25	
BSW10110	M10-1.5 X 110	25	
BSW10120	M10-1.5 X 120	25	
BSW12016	M12-1.75 X 16	50	
BSW12020	M12-1.75 X 20	50	
BSW12025	M12-1.75 X 25	50	
BSW12030	M12-1.75 X 30	50	
BSW12035	M12-1.75 X 35	50	
BSW12040	M12-1.75 X 40	25	
BSW12045	M12-1.75 X 45	25	
BSW12050	M12-1.75 X 50	25	
BSW12055	M12-1.75 X 55	25	
BSW12060	M12-1.75 X 60	25	
BSW12070	M12-1.75 X 70	25	
BSW12080	M12-1.75 X 80	25	
BSW12090	M12-1.75 X 90	25	
BSW12100	M12-1.75 X 100	25	
BSW12110	M12-1.75 X 110	25	
BSW12120	M12-1.75 X 120	25	
BSW16025	M16-2.0 X 25	25	
BSW16030	M16-2.0 X 30	25	
BSW16035	M16-2.0 X 35	25	
BSW16040	M16-2.0 X 40	25	
BSW16045	M16-2.0 X 45	25	
BSW16050	M16-2.0 X 50	25	
BSW16055	M16-2.0 X 55	15	
BSW16060	M16-2.0 X 60	15	
BSW16070	M16-2.0 X 70	15	
BSW16080	M16-2.0 X 80	15	
BSW16090	M16-2.0 X 90	15	
BSW16100	M16-2.0 X 100	15	
BSW16110	M16-2.0 X 110	10	
BSW16120	M16-2.0 X 120	10	
BSW20040	M20-2.5 X 40	25	

(continued...)

**SOCKET CAP SCREW - DIN 912 (cont.)**

A2 - 304 STAINLESS STEEL

Line: 1670-20

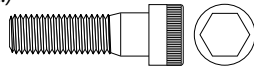

PART NUMBER	SIZE	QTY/BX	LIST PRICE
<b>BSW20045</b>	M20-2.5 X 45	25	
<b>BSW20050</b>	M20-2.5 X 50	25	
<b>BSW20060</b>	M20-2.5 X 60	10	
<b>BSW20070</b>	M20-2.5 X 70	10	
<b>BSW20080</b>	M20-2.5 X 80	10	
<b>BSW20090</b>	M20-2.5 X 90	10	
<b>BSW20100</b>	M20-2.5 X 100	10	
<b>BSW20110</b>	M20-2.5 X 110	10	
<b>BSW20120</b>	M20-2.5 X 120	10	
<b>BSW20140</b>	M20-2.5 X 140	10	

**SOCKET SET SCREW - DIN 916**

A2 - 304 STAINLESS STEEL

Line: 1670-21

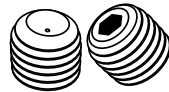

PART NUMBER	SIZE	QTY/BX	LIST PRICE
<b>BSX03003</b>	M3-0.5 X 3	100	
<b>BSX03004</b>	M3-0.5 X 4	100	
<b>BSX03005</b>	M3-0.5 X 5	100	
<b>BSX03006</b>	M3-0.5 X 6	100	
<b>BSX04004</b>	M4-0.7 X 4	100	
<b>BSX04005</b>	M4-0.7 X 5	100	
<b>BSX04006</b>	M4-0.7 X 6	100	
<b>BSX04008</b>	M4-0.7 X 8	100	
<b>BSX04010</b>	M4-0.7 X 10	100	
<b>BSX04012</b>	M4-0.7 X 12	100	
<b>BSX04016</b>	M4-0.7 X 16	100	
<b>BSX04020</b>	M4-0.7 X 20	100	
<b>BSX04025</b>	M4-0.7 X 25	100	
<b>BSX04030</b>	M4-0.7 X 30	100	
<b>BSX05005</b>	M5-0.8 X 5	100	
<b>BSX05006</b>	M5-0.8 X 6	100	
<b>BSX05008</b>	M5-0.8 X 8	100	
<b>BSX05010</b>	M5-0.8 X 10	100	
<b>BSX05016</b>	M5-0.8 X 16	100	
<b>BSX05020</b>	M5-0.8 X 20	100	
<b>BSX05025</b>	M5-0.8 X 25	100	
<b>BSX05030</b>	M5-0.8 X 30	100	
<b>BSX06006</b>	M6-1.0 X 6	100	
<b>BSX06008</b>	M6-1.0 X 8	100	
<b>BSX06010</b>	M6-1.0 X 10	100	

(continued...)

**SOCKET SET SCREW - DIN 916 (cont.)**

A2 - 304 STAINLESS STEEL

Line: 1670-21

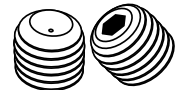

PART NUMBER	SIZE	QTY/BX	LIST PRICE
<b>BSX06012</b>	M6-1.0 X 12	100	
<b>BSX06016</b>	M6-1.0 X 16	100	
<b>BSX06020</b>	M6-1.0 X 20	100	
<b>BSX06025</b>	M6-1.0 X 25	100	
<b>BSX06030</b>	M6-1.0 X 30	100	
<b>BSX06035</b>	M6-1.0 X 35	100	
<b>BSX06040</b>	M6-1.0 X 40	100	
<b>BSX08008</b>	M8-1.25 X 8	100	
<b>BSX08010</b>	M8-1.25 X 10	100	
<b>BSX08012</b>	M8-1.25 X 12	100	
<b>BSX08016</b>	M8-1.25 X 16	100	
<b>BSX08020</b>	M8-1.25 X 20	100	
<b>BSX08025</b>	M8-1.25 X 25	100	
<b>BSX08030</b>	M8-1.25 X 30	100	
<b>BSX08035</b>	M8-1.25 X 35	100	
<b>BSX08040</b>	M8-1.25 X 40	100	
<b>BSX10010</b>	M10-1.5 X 10	100	
<b>BSX10012</b>	M10-1.5 X 12	100	
<b>BSX10016</b>	M10-1.5 X 16	100	
<b>BSX10020</b>	M10-1.5 X 20	100	
<b>BSX10025</b>	M10-1.50 X 25	100	
<b>BSX10030</b>	M10-1.50 X 30	100	
<b>BSX10035</b>	M10-1.50 X 35	100	
<b>BSX10040</b>	M10-1.50 X 40	100	
<b>BSX12012</b>	M12-1.75 X 12	50	
<b>BSX12016</b>	M12-1.75 X 16	50	
<b>BSX12020</b>	M12-1.75 X 20	50	
<b>BSX12025</b>	M12-1.75 X 25	50	
<b>BSX12030</b>	M12-1.75 X 30	50	
<b>BSX12035</b>	M12-1.75 X 35	50	
<b>BSX12040</b>	M12-1.75 X 40	50	
<b>BSX16016</b>	M16-2.0 X 16	50	
<b>BSX16020</b>	M16-2.0 X 20	50	
<b>BSX16025</b>	M16-2.0 X 25	50	
<b>BSX16030</b>	M16-2.0 X 30	50	
<b>BSX16040</b>	M16-2.0 X 40	50	



# FLAT SOCKET CAP SCREW - DIN 7991

A2 - 304 STAINLESS STEEL

Line: 1670-22

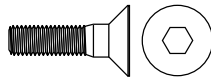

PART NUMBER	SIZE	QTY/BX	LIST PRICE
BTW03010	M3-0.5 X 10	100	
BTW03016	M3-0.5 X 16	100	
BTW04006	M4-0.7 X 6	100	
BTW04008	M4-0.7 X 8	100	
BTW04010	M4-0.7 X 10	100	
BTW04012	M4-0.7 X 12	100	
BTW04016	M4-0.7 X 16	100	
BTW04020	M4-0.7 X 20	100	
BTW04025	M4-0.7 X 25	100	
BTW04030	M4-0.7 X 30	100	
BTW04035	M4-0.7 X 35	100	
BTW04040	M4-0.7 X 40	100	
BTW05010	M5-0.8 X 10	100	
BTW05012	M5-0.8 X 12	100	
BTW05016	M5-0.8 X 16	100	
BTW05020	M5-0.8 X 20	100	
BTW05025	M5-0.8 X 25	100	
BTW05030	M5-0.8 X 30	100	
BTW05035	M5-0.8 X 35	100	
BTW05040	M5-0.8 X 40	100	
BTW05050	M5-0.8 X 50	100	
BTW05060	M5-0.8 X 60	100	
BTW06008	M6-1.0 X 8	100	
BTW06010	M6-1.0 X 10	100	
BTW06012	M6-1.0 X 12	100	
BTW06016	M6-1.0 X 16	100	
BTW06020	M6-1.0 X 20	100	
BTW06025	M6-1.0 X 25	50	
BTW06030	M6-1.0 X 30	50	
BTW06035	M6-1.0 X 35	50	
BTW06040	M6-1.0 X 40	50	
BTW06045	M6-1.0 X 45	50	
BTW06050	M6-1.0 X 50	50	
BTW06060	M6-1.0 X 60	50	
BTW06070	M6-1.0 X 70	50	
BTW06080	M6-1.0 X 80	50	
BTW08012	M8-1.25 X 12	100	
BTW08016	M8-1.25 X 16	100	
BTW08020	M8-1.25 X 20	100	

(continued...)

# FLAT SOCKET CAP SCREW - DIN 7991 (cont.)

A2 - 304 STAINLESS STEEL

Line: 1670-22

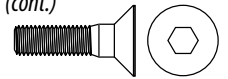

PART NUMBER	SIZE	QTY/BX	LIST PRICE
BTW08025	M8-1.25 X 25	50	
BTW08030	M8-1.25 X 30	50	
BTW08035	M8-1.25 X 35	50	
BTW08040	M8-1.25 X 40	50	
BTW08045	M8-1.25 X 45	50	
BTW08050	M8-1.25 X 50	50	
BTW08060	M8-1.25 X 60	50	
BTW08070	M8-1.25 X 70	50	
BTW08080	M8-1.25 X 80	50	
BTW10020	M10-1.5 X 20	100	
BTW10025	M10-1.5 X 25	50	
BTW10030	M10-1.5 X 30	50	
BTW10035	M10-1.5 X 35	25	
BTW10040	M10-1.5 X 40	50	
BTW10045	M10-1.5 X 45	50	
BTW10050	M10-1.5 X 50	50	
BTW10060	M10-1.5 X 60	25	
BTW10070	M10-1.5 X 70	25	
BTW10080	M10-1.5 X 80	25	
BTW12020	M12-1.75 X 20	50	
BTW12025	M12-1.75 X 25	50	
BTW12030	M12-1.75 X 30	50	
BTW12035	M12-1.75 X 35	50	
BTW12040	M12-1.75 X 40	25	
BTW12045	M12-1.75 X 45	25	
BTW12050	M12-1.75 X 50	25	
BTW12060	M12-1.75 X 60	25	
BTW12070	M12-1.75 X 70	25	
BTW12080	M12-1.75 X 80	25	
BTW12090	M12-1.75 X 90	25	
BTW16030	M16-2.0 X 30	25	
BTW16035	M16-2.0 X 35	25	
BTW16040	M16-2.0 X 40	25	
BTW16045	M16-2.0 X 45	10	
BTW16050	M16-2.0 X 50	10	

**METRIC BUTTON SOCKET CAP SCREW**

A2 - 304 STAINLESS STEEL - DIN 7380

Line: 1670-23

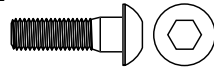

PART NUMBER	SIZE	QTY/BX	LIST PRICE
<b>BRL03006</b>	M3-0.5 X 6	100	
<b>BRL03008</b>	M3-0.5 X 8	100	
<b>BRL03010</b>	M3-0.5 X 10	100	
<b>BRL03012</b>	M3-0.5 X 12	100	
<b>BRL04008</b>	M4-0.7 X 8	100	
<b>BRL04010</b>	M4-0.7 X 10	100	
<b>BRL04012</b>	M4-0.7 X 12	100	
<b>BRL04016</b>	M4-0.7 X 16	100	
<b>BRL05010</b>	M5-0.8 X 10	100	
<b>BRL05012</b>	M5-0.8 X 12	100	
<b>BRL05016</b>	M5-0.8 X 16	100	
<b>BRL06010</b>	M6-1.0 X 10	100	
<b>BRL06012</b>	M6-1.0 X 12	100	
<b>BRL06016</b>	M6-1.0 X 16	100	
<b>BRL06020</b>	M6-1.0 X 20	100	
<b>BRL06025</b>	M6-1.0 X 25	100	
<b>BRL06030</b>	M6-1.0 X 30	100	
<b>BRL08010</b>	M8-1.25 X 10	100	
<b>BRL08012</b>	M8-1.25 X 12	100	
<b>BRL08016</b>	M8-1.25 X 16	100	
<b>BRL08020</b>	M8-1.25 X 20	100	
<b>BRL08025</b>	M8-1.25 X 25	100	
<b>BRL08030</b>	M8-1.25 X 30	100	
<b>BRL08035</b>	M8-1.25 X 35	100	
<b>BRL08040</b>	M8-1.25 X 40	100	
<b>BRL10016</b>	M10-1.5 X 16	50	
<b>BRL10020</b>	M10-1.5 X 20	50	
<b>BRL10025</b>	M10-1.5 X 25	25	
<b>BRL10035</b>	M10-1.5 X 35	25	

**METRIC LOW HD SOCKET CAP SCREW**

A2 - 304 STAINLESS STEEL - DIN 6912

Line: 1672-23

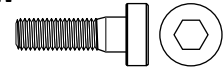

PART NUMBER	SIZE	QTY/BX	LIST PRICE
<b>BTY03012</b>	M3 X 12	100	
<b>BTY04010</b>	M4 X 10	100	
<b>BTY04012</b>	M4 X 12	100	
<b>BTY05012</b>	M5 X 12	100	
<b>BTY05016</b>	M5 X 16	100	
<b>BTY05020</b>	M5 X 20	100	
<b>BTY05025</b>	M5 X 25	100	
<b>BTY06012</b>	M6 X 12	100	
<b>BTY06016</b>	M6 X 16	100	
<b>BTY06020</b>	M6 X 20	100	
<b>BTY06025</b>	M6 X 25	100	
<b>BTY06030</b>	M6 X 30	100	
<b>BTY06050</b>	M6 X 50	100	
<b>BTY08016</b>	M8 X 16	50	
<b>BTY08020</b>	M8 X 20	50	
<b>BTY08025</b>	M8 X 25	50	
<b>BTY08030</b>	M8 X 30	50	
<b>BTY08040</b>	M8 X 40	50	
<b>BTY08050</b>	M8 X 50	50	
<b>BTY08060</b>	M8 X 60	50	
<b>BTY10020</b>	M10 X 20	50	
<b>BTY10025</b>	M10 X 25	25	
<b>BTY10030</b>	M10 X 30	25	
<b>BTY10035</b>	M10 X 35	25	
<b>BTY10040</b>	M10 X 40	25	
<b>BTY10050</b>	M10 X 50	25	



**CALL - 1 (800) 723-2826**

# METRIC FASTENER SPECIFICATIONS (AT A GLANCE)

MORE SPECIFICATIONS CAN BE FOUND IN THE TECHNICAL SECTION LOCATED AT THE END OF THE CATALOG.

## THREAD DIAMETER

STANDARD PITCH	FINE PITCH
M3-0.5	
M4-0.7	
M5-0.8	
M6-1.0	
M8-1.25	M8-1.0
M10-1.5	M10-1.25 M10-1.0
M12-1.75	M12-1.25 M12-1.5
M14-2.0	M14-1.5
M16-2.0	M16-1.5
M18-2.5	M18-1.5
M20-2.5	M20-1.5
M22-2.5	M22-1.5
M24-3.0	M24-2.0
M27-3.0	(M27-2.0)
M30-3.5	(M30-2.0)

## THREADS

METRIC (MM)	INCH (APPROX.)	PITCH (MM)
3	4-40	0.5
3.5	6-32	0.6
4	8-32	0.7
5	10-24	0.8
6	1/4"	1.0
8	5/16"	1.25
10	3/8"	1.5
12	1/2"	1.75
14	9/16"	2.0
16	5/8"	2.0
18	11/16"	2.5
20	3/4"	2.5
22	7/8"	2.5
24	1"	3.0
27	1 1/16"	3.0
30	1 3/16"	3.5

## LENGTH

METRIC (MM)	INCH (APPROX.)	METRIC (MM)	INCH (APPROX.)
1	3/64"	90	3 1/2"
1.5	1/16"	100	4"
2	5/64"	110	4 3/8"
3	1/8"	120	4 3/4"
4	5/32"	130	5"
5	3/16"	140	5 1/2"
6	1/4"	150	6"
8	5/16"	160	6 1/4"
10	3/8"	170	6 3/4"
12	1/2"	180	7"
14	9/16"	190	7 1/2"
16	5/8"	200	8"
18	11/16"	220	8 3/4"
19	3/4"	240	9 9/16"
20	3/4"	260	10 1/4"
25	1"	270	10 3/4"
30	1 3/16"	280	11"
35	1 3/8"	300	12"
40	1 9/16"	320	12 1/2"
45	1 3/4"	340	13 1/2"
50	2"	360	14 1/4"
55	2 3/16"	380	15"
60	2 3/8"	400	15 3/4"
65	2 9/16"	420	16 1/2"
70	2 3/4"	440	17 3/8"
75	3"	460	18"
80	3 3/16"	480	19"
85	3 3/8"	500	20"

# SECTION 19 PRODUCT INDEX



## STORAGE EQUIPMENT

Line Description	Alpha	Line#	Page#
STEEL DRAWER CABINETS - GRAY	BFC	1900-00	19-3
STEEL BIN BASES - GRAY	BFC	1902-00	19-3
STEEL 12"X18" COMPARTMENT TRAYS - GRAY	BFC	1903-00	19-3
DIVIDERS FOR COMPARTMENT TRAYS - GRAY	BFC	1903-05	19-3
STEEL 9"X13" COMPARTMENT TRAYS - GRAY	BFC	1904-00	19-3
PLASTIC/POLY COMPARTMENT TRAYS	BFC	1904-01	19-4
STEEL PIGEON HOLE BINS - GRAY	BFC	1906-00	19-4
STEEL DRAWER RACKS & MISCELLANEOUS STORAGE	BFC	1907-00	19-5

## ASSORTMENTS

Line Description	Alpha	Line#	Page#
HEX CAP SCREW NUT & WASHER BIN ASSORTMENTS	JXL	1911-00	19-6
MACHINE SCREW TRAY ASSORTMENTS	JBD	1912-00	19-7
SHEET METAL SCREW TRAY ASSORTMENTS	JBD	1913-00	19-7
PHILLIPS FLAT WOOD SCREW TRAY ASSORTMENTS	JBD	1913-01	19-8
HEX (TEK) DRILL SCREW TRAY ASSORTMENTS	JBD	1914-00	19-8
SOCKET SCREW PRODUCTS TRAY ASSORTMENTS	JBD	1915-00	19-8
COTTER PIN TRAY ASSORTMENTS	JBD	1916-00	19-8
SPIRAL COIL PIN TRAY ASSORTMENTS	JBD	1917-00	19-9
SPLIT TENSION PIN TRAY ASSORTMENTS	JBD	1918-00	19-9
UNIVERSAL CLEVIS PIN TRAY ASSORTMENTS	JBD	1919-00	19-9
WOODRUFF KEYS TRAY ASSORTMENTS	JBD	1920-00	19-9
INT/EXT RETAINING RING TRAY ASSORTMENTS	YZB	1921-00	19-9
RETAINING RING TRAY ASSORTMENTS	JBD	1923-00	19-9
SQUARE KEY STOCK RACK ASSORTMENTS	JBD	1924-00	19-10
THREADED ROD RACK ASSORTMENTS	AML	1924-20	19-10
HOSE CLAMP RACK ASSORTMENTS	AML	1925-01	19-10
AIR BRAKE BRASS TUBE FITTING TRAY ASSORTMENTS	JBD	1926-00	19-11
PIPE THREAD BRASS FITTING TRAY ASSORTMENTS	JBD	1927-00	19-11
COMPRESSION BRASS FITTING TRAY ASSORTMENTS	JBD	1928-00	19-11
INVERTED FLARE BRASS FITTING TRAY ASSORTMENTS	JBD	1929-00	19-11
SAE FLARE BRASS FITTING TRAY ASSORTMENTS	JBD	1930-00	19-11
POLY FLOW BRASS FITTING TRAY ASSORTMENTS	JBD	1932-00	19-11
J844 NYLON TRUCK TUBE BRASS TRAY ASSORTMENTS	JBD	1933-00	19-11
BLACK IRON PIPE FITTING TRAY ASSORTMENTS	JBD	1933-01	19-11
STAINLESS STEEL PIPE FITTING TRAY ASSORTMENTS	JBD	1933-01	19-12
BLIND RIVET ASSORTMENTS	JBD	1934-00	19-12
LOW PRESSURE PUSH-ON HOSE FITTING ASSORTMENTS	JBD	1935-00	19-12
ELECTRICAL WIRE TERMINAL ASSORTMENTS	JBD	1937-00	19-12
ELECTRICAL WIRE NUT AWG SERIES	JBD	1937-01	19-12

(CONTINUED...)

# SECTION 19 PRODUCT INDEX

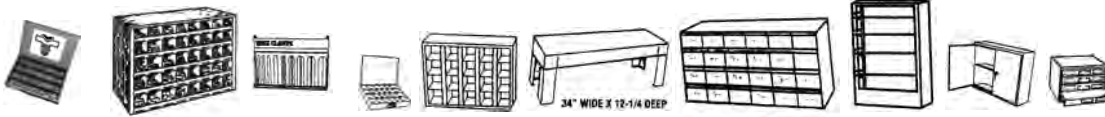

## ASSORTMENTS (cont.)

Line Description	Alpha	Line#	Page#
HEAT SHRINK DOUBLE WALL TUBING	JBD	1937-02	19-13
NYLON CABLE TIE ASSORTMENT	JBD	1937-03	19-13
GREASE FITTING ASSORTMENT	JBD	1938-00	19-13
RUBBER O-RING ASSORTMENT	JBD	1939-00	19-13
CUSTOM ASSORTMENTS	JBD	1939-20	19-20
METRIC HEX CAP SCREW 8.8 WITH NUTS ASSORTMENT	CPC	1940-00	19-20
METRIC SOCKET CAP SCREW 12.9 ASSORTMENT	CPC	1941-00	19-20
METRIC MACHINE SCREW ASSORTMENT	JBD	1942-00	19-21
METRIC SET SCREW/FLAT SOC CAP SC ASSORTMENT	CPC	1943-00	19-21

### CAP SCREW ASSORTMENTS

40 COMPARTMENT BINS



3251 Piece Assortment  
1/4 thru 1/2" Diameter  
1/2 thru 3" Length



**ALL DOMESTIC PRODUCT**

PART NUMBER	ASSORTMENT TYPE
JXL3251 NC	GRADE 5 - UNC - ZINC PLATED
JXL3251 NF	GRADE 5 - UNF - ZINC PLATED
JXL3251 GR8 NC	GRADE 8 - UNC - ZINC YELLOW
JXL3251 GR8 NF	GRADE 8 - UNF - ZINC YELLOW



**CANADIAN OR IMPORT PRODUCT**

PART NUMBER	ASSORTMENT TYPE
JXL JJM NC	GRADE 5 - UNC - ZINC PLATED
JXL JTR NF	GRADE 5 - UNF - ZINC PLATED
JXL JKR NC	GRADE 8 - UNC - ZINC YELLOW
JXL JAS NF	GRADE 8 - UNF - ZINC YELLOW
JXLM109	10.9 METRIC (M6-M16) 1865 PIECES
JXLM88	8.8 METRIC (M6-M16) COARSE THREAD
JXLM88F	8.8 METRIC (M6-M16) FINE THREAD

### CUSTOM PACKAGING SERVICES AVAILABLE!!

6 HIGH SPEED  
DELTA SYSTEMS  
IN HOUSE!



**WE ARE READY TO SERVE YOUR VOLUME BOXED PACKAGING REQUIREMENTS!!!**

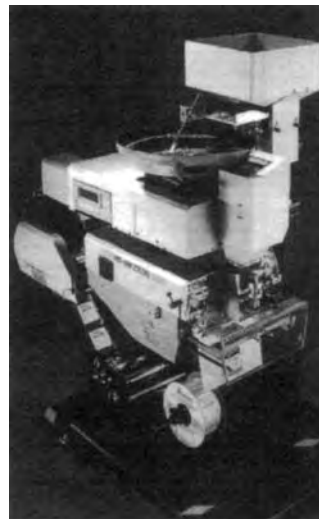

WE ARE READY TO SERVE YOUR POLY BAG PACKAGING REQUIREMENTS WITH:  
**4 AUTOMATED HIGH SPEED BAGGERS WITH LABELING SYSTEMS!**

## STEEL DRAWER CABINETS

Line: 1900-00



PART NUMBER	SIZE	DESCRIPTION	QTY/BOX
<b>BFC2218</b>	34W X 12D X 13H	18 Drawer Steel Cabinet - Color Gray	1
<b>BFC24D</b>	34W X 12D X 17H	24 Drawer Steel Cabinet - Color Gray	1
<b>BFC2417D</b>	34W X 12D X 17H	24 Drawer Steel Cabinet - Color Gray	1

## STEEL BIN BASES

Line: 1902-00

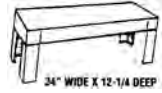

PART NUMBER	SIZE	DESCRIPTION	QTY/BOX
<b>BFCBBC</b>	BIN	Steel Bin Base (Use with Pigeon Hole Bins) - Color Gray	1
<b>BFCBBCLEG</b>	LEGS FOR BBC-12	Steel Bin Base Legs (Replacement legs for BFCBBC bin base) - Color Gray	4

## STEEL COMPARTMENT TRAYS

12 X 18 INCH

Line: 1903-00



PART NUMBER	SIZE	DESCRIPTION	QTY/BOX
<b>BFCADLH</b>	ADJ COMP HORZ	Steel Compartment Trays - Color Gray	1
<b>BFCADLHDIV</b>	DIVIDERS FOR BFCADLH	Plastic Dividers for BFCADLH - Color Gray	12
<b>BFCEXL</b>	ADJ. COMP VERT & HORZ	Steel Compartment Trays - Color Gray	1
<b>BFC2AD</b>	ADJUSTABLE	Steel Compartment Trays - Color Gray	1
<b>BFC6VC</b>	6 VERT COMP	Steel Compartment Trays - Color Gray	1
<b>BFC12L</b>	12 COMP	Steel Compartment Trays - Color Gray	1
<b>BFC16L</b>	16 COMP	Steel Compartment Trays - Color Gray	1
<b>BFC20L</b>	20 COMP	Steel Compartment Trays - Color Gray	1
<b>BFC21L</b>	21 COMP	Steel Compartment Trays - Color Gray	1
<b>BFC24L</b>	24 COMP	Steel Compartment Trays - Color Gray	1
<b>BFC32L</b>	32 COMP	Steel Compartment Trays - Color Gray	1

## DIVIDERS FOR ADJUSTABLE TRAY INSERTS

Line: 1903-05

PART NUMBER	SIZE	DESCRIPTION	QTY/BOX
<b>BFCDIV</b>	ADJ TRAY	Adjustable Tray Insert Dividers.	9

## STEEL COMPARTMENT TRAYS

9 X 13 INCH

Line: 1904-00



PART NUMBER	SIZE	DESCRIPTION	QTY/BOX
<b>BFC8B</b>	8 COMP	Steel Compartment Trays - Color Gray	1
<b>BFC12B</b>	12 COMP	Steel Compartment Trays - Color Gray	1
<b>BFC16B</b>	16 COMP	Steel Compartment Trays - Color Gray	1
<b>BFC20B</b>	20 COMP	Steel Compartment Trays - Color Gray	1
<b>BFC21B</b>	21 COMP	Steel Compartment Trays - Color Gray	1
<b>BFC24B</b>	24 COMP	Steel Compartment Trays - Color Gray	1

**PLASTIC/POLY COMPARTMENT TRAYS**

Line: 1904-01



PART NUMBER	SIZE	DESCRIPTION	QTY/BOX
<b>BFACT203</b>	6 COMP 8 1/4 X 4 1/2	Clear Plastic Compartment Trays	1
<b>BFC6BPLTC</b>	6 COMP 11 X 6 3/4	Clear Plastic Compartment Trays	1
<b>BFCSPADJCLR</b>	ADJ.11 X 6 3/4 15 DIV	Clear Plastic Compartment Trays	1
<b>BFC12BPLTC</b>	12 COMP 11 X 6 3/4	Clear Plastic Compartment Trays	1
<b>BFCM623YEL</b>	13 COMP 11 X 6 3/4	Yellow Plastic Compartment Trays	1
<b>BFC18BPLTC</b>	18 COMP 11 X 6 3/4	Clear Plastic Compartment Trays	1

**STEEL PIGEON HOLE BINS**

Line: 1906-00

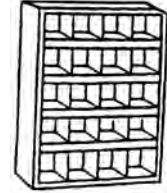

PART NUMBER	SIZE	DESCRIPTION	QTY/BOX
<b>BFC8H</b>	8 HOLE	Steel Pigeon Hole Bins - Color Gray	1
<b>BFC16H</b>	16 HOLE	Steel Pigeon Hole Bins - Color Gray	1
<b>BFC18H</b>	18 HOLE	Steel Pigeon Hole Bins - Color Gray	1
<b>BFC20H</b>	20 HOLE	Steel Pigeon Hole Bins - Color Gray	1
<b>BFC24H</b>	24 HOLE	Steel Pigeon Hole Bins - Color Gray	1
<b>BFC28H</b>	28 HOLE (9 DEEP)	Steel Pigeon Hole Bins - Color Gray	1
<b>BFC32H</b>	32 HOLE	Steel Pigeon Hole Bins - Color Gray	1
<b>BFC36H</b>	36 HOLE	Steel Pigeon Hole Bins - Color Gray	1
<b>BFCM36B</b>	36 HOLE 23 5/8 X 23 5/8	Steel Pigeon Hole Bins - Color Gray	1
<b>BFC40H</b>	40 HOLE	Steel Pigeon Hole Bins - Color Gray	1
<b>BFC40HBL</b>	40 HOLE (BLUE)	Steel Pigeon Hole Bins - Color Blue	1
<b>BFC42H</b>	42 HOLE	Steel Pigeon Hole Bins - Color Gray	1
<b>BFC56H</b>	56 HOLE	Steel Pigeon Hole Bins - Color Gray	1
<b>BFC72H</b>	72 HOLE	Steel Pigeon Hole Bins - Color Gray	1
<b>BFC72HBL</b>	72 HOLE (BLUE)	Steel Pigeon Hole Bins - Color Blue	1



**CALL - 1 (800) 723-2826**

# STEEL DRAWER RACKS &

MISCELLANEOUS STORAGE UNITS

Line: 1907-00



PART NUMBER	SIZE	DESCRIPTION	QTY/BOX
<b>BFC-BLR</b>	RACK STAND LARGE SIZE	Slide Rack Stand Large (use with BFC-L24R) - Color Gray	1
<b>BFC-BLRLEG</b>	LEGS FOR BLR	Replacement Legs for BFC-BLR Slide Rack Stand- Color Gray	1
<b>BFC-BLRTT</b>	BLR-TT RACK BASE SMALL	Slide Rack Stand Small (use with BFC-4SR) - Color Gray	1
<b>BFC-C6</b>	15W X 12D X 16H	Steel Small 6 Drawer Slide Rack for 9 X 13 Trays - Color Gray	1
<b>BFC-L24R</b>	20W X 16D X 15H	Steel Large 4 Drawer Slide Rack for 12 X 18 Trays - Color Gray	1
<b>BFC-3RR</b>	24W X 7D X 24H	Steel Threaded Rod Rack 18 Sizes	1
<b>BFC-4SR</b>	15W X 12D X 11H	Steel Small 4 Drawer Slide Rack for 9 X 13 Trays - Color Gray	1
<b>BFCAC6</b>	22W X 3D X 5H	Steel 6 Can Aerosol Caddy - Color Gray	1
<b>BFCAU1</b>	34W X 9D X 22H	Steel Aerosol / Utility Cabinet - Color Gray	1
<b>BFCAU3</b>	20W X 14D X 33H	Steel Aerosol / Utility Cabinet - Color Gray	1
<b>BFCR200PR</b>	HOSE CLAMP 7/SIZE	Plastic Hose Clamp Rack 7 Sizes	1
<b>BFCR200PR10XX</b>	HOSE CLAMP 10/SIZE	Steel Wire Hose Clamp Rack 10 Sizes	1
<b>BFC312</b>	PLT LK HINGE FOR 4LR	Locking Hinge (use with BFC-L24R) 4 Drawer Large 12 X 18 Slide Rack	1
<b>BFC313</b>	PLT LK HINGE FOR 4SR	Locking Hinge (use with BFC-4SR) 4 Drawer Small 9 X 13 Slide Rack	1
<b>BFC365</b>	#365 (FOR BFC72H)	Steel Hinged Doors (use with BFC72H) - Color Gray	1
<b>BFC366</b>	#366 (FOR BFC40H)	Steel Hinged Doors (use with BFC40H) - Color Gray	1
<b>BFC7820</b>	12W X 6D X 12H	Steel Key Stock Rack 10 Compartments - Color Gray	1
<b>BFCWSR1</b>	26W X 6D X 10H	Steel Wire Spool Rack 1 Rod - Color Gray	1
<b>BFC-2LR</b>	20W X 16D X 8H	Steel Large 2 Drawer Slide Rack for 12 X 18 Trays - Color Gray	1
<b>BFCWSR2</b>	26W X 6D X 18H	Steel Wire Spool Rack 2 Rod - Color Gray	1
<b>BFCWSR4</b>	26W X 6D X 37H	Steel Wire Spool Rack 4 Rod - Color Gray	1
<b>BFCSPR</b>	5 DR.POLY TRAY RACK	Steel 5 Compartment Rack for Plastic Ploy Trays - Color Gray	1



**BIN ASSORTMENTS**

HEX CAP SCREW, NUT, AND WASHER

Line: 1911-00

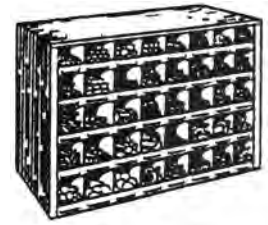

PART NUMBER	SIZE	DESCRIPTION	QTY/BOX
<b>JXLHDG</b>	1/4 thru 1/2 (40 Hole Bin)	Grade 2 Hot Dip Galvanized Hex Head Cap Screws - 2501 Pieces	1
<b>JXLJASNF</b>	1/4 thru 1/2 (40 Hole Bin)	Grade 8 Hex Head Cap Screws SAE Fine Thread Y/Z - North American - 2851 Pieces	1
<b>JXL3251GR8NC</b>	1/4 thru 1/2 (40 Hole Bin)	Grade 8 Hex Head Cap Screws USS Course Thread Y/Z - U.S.A. - 2851 Pieces	1
<b>JXL3251GR8NF</b>	1/4 thru 1/2 (40 Hole Bin)	Grade 8 Hex Head Cap Screws SAE Fine Thread Y/Z - U.S.A. - 2851 Pieces	1
<b>JXL3251NC</b>	1/4 thru 1/2 (40 Hole Bin)	Grade 5 Hex Head Cap Screws USS Course Thread Z/P - U.S.A. - 2851 Pieces	1
<b>JXL3251NF</b>	1/4 thru 1/2 (40 Hole Bin)	Grade 5 Hex Head Cap Screws SAE Fine Thread Z/P - U.S.A. - 2851 Pieces	1
<b>JXLJASNFNB</b>	1/4 thru 1/2 NO BIN bolts only	Grade 8 Hex Head Cap Screws SAE Fine Thread Y/Z - U.S.A. - 2850 Pieces	1
<b>JXLJMN</b>	1/4 thru 1/2 (40 Hole Bin)	Grade 5 Hex Head Cap Screws USS Course Thread Z/P - North American - 2851 Pieces	1
<b>JXLJMN CNB</b>	1/4 thru 1/2 NO BIN bolts only	Grade 5 Hex Head Cap Screws USS Course Thread Z/P - North American - 2850 Pieces	1
<b>JXLJKRNC</b>	1/4 thru 1/2 (40 Hole Bin)	Grade 8 Hex Head Cap Screws USS Course Thread Y/Z - North American - 2851 Pieces	1
<b>JXLJKRNCNB</b>	1/4 thru 1/2 NO BIN bolts only	Grade 8 Hex Head Cap Screws USS Course Thread Y/Z - North American - 2850 Pieces	1
<b>JXLJMRNC</b>	1/4 thru 1/2 (40 Hole Bin)	Alloy Socket Head Cap Screws USS Course Thread P/F - 2851 Pieces	1
<b>JXLJTRNF</b>	1/4 thru 1/2 (40 Hole Bin)	Grade 5 Hex Head Cap Screws SAE Fine Thread Z/P - North American - 2851 Pieces	1
<b>JXLJTRNFNB</b>	1/4 thru 1/2 NO BIN bolts only	Grade 5 Hex Head Cap Screws SAE Fine Thread Z/P - North American - 2850 Pieces	1
<b>JXLCDC</b>	M6 thru M16 (40 Hole Bin)	Metric 12.9 Socket Head Cap Screws Course Thread Din 912 P/F - 1866 Pieces	1
<b>JXLM A2</b>	M6 thru M16 (40 Hole Bin)	Metric A2 Stainless Socket Head Cap Screws Course Thread - 1866 Pieces	1
<b>JXLM88</b>	M6 thru M16 (40 Hole Bin)	Metric 8.8 Hex Head Cap Screws Course Thread Z/P - 1866 Pieces	1
<b>JXLM88F</b>	M6 thru M16 (40 Hole Bin)	Metric 8.8 Hex Head Cap Screws Fine Thread Z/P - 1866 Pieces	1
<b>JXLM109</b>	M6 thru M16 (40 Hole Bin)	Metric 10.9 Hex Head Cap Screws Course Thread Y/Z - 1866 Pieces	1



**CALL - 1 (800) 723-2826**

# ASSORTMENTS

## 12" x 18" STEEL TRAYS

### MACHINE SCREWS

Line: 1912-00

PART NUMBER	SIZE	DESCRIPTION	QTY/BOX
JBDL24DRA50A	6/32 thru 1/4-20 (24 comp)	Indented Hex Head Machine Screws with Nuts Z/P - 1200 Pieces	1
JBDL24EBANFE	6/32 thru 10/32 (24 comp)	Slotted Round Head Machine Screws w/ Nuts, Washers, Ext. Lock Wash 18-8 S/S - 1200 PC	1
JBDL24IHMS25	6/32 thru 1/4-20 (24 comp)	Indented Hex Head Machine Screws Z/P - 600 Pieces	1
JBDL24JJF	6/32 thru 1/4-20 (24 comp)	Phillips Flat Head Machine Screws 18-8 Stainless Steel - 600 Pieces	1
JBDL24JJFWN	6/32 thru 1/4-20 (24 comp)	Phillips Flat Head Machine Screws with Nuts 18-8 Stainless Steel - 1200 Pieces	1
JBDL24PFMS50	6/32 thru 1/4-20 (24 comp)	Phillips Flat Head Machine Screws with Nuts Z/P - 1200 Pieces	1
JBDL24PHMS25S	6/32 thru 1/4-20 (24 comp)	Phillips Pan Head Machine Screws 18-8 Stainless Steel - 600 Pieces	1
JBDL24PHNMS	6/32 thru 10/32 (24 comp)	Phillips Pan Head Machine Screws with Nuts & Washers Z/P - 1200 Pieces	1
JBDL24POMS25S	6/32 thru 1/4-20 (24 comp)	Phillips Oval Head Machine Screws 18-8 Stainless Steel - 600 Pieces	1
JBDL24PPMS50A	6/32 thru 1/4-20 (24 comp)	Phillips Pan Head Machine Screws with Nuts Z/P	1
JBDL24PRMS50	6/32 thru 10/32 (24 comp)	Phillips Round Head Machine Screws with Nuts, Washers & Lock Washers Z/P - 1200 Pieces	1
JBDL24RHMS50	6/32 thru 10/32 (24 comp)	Slotted Round Head Machine Screws with Nuts, Washers & Lock Washers Z/P - 1200 Pieces	1
JBDL24RMS50A	6/32 thru 1/4-20 (24 comp)	Slotted Round Head Machine Screws with Nuts Z/P - 1200 Pieces	1
JBDL24HNLWLN	6/32 thru 1/4-20 (24 comp)	Machine Screw Hex Nut, Lock Nut, Washer, Lock Washer, Ext. Lock Washer Z/P - 600 Pieces	1
JBDL24WNLNSX	6/32 thru 1/4-20 (24 comp)	Machine Screw Hex Nut, Lock Nut, Washer, Lock Washer, Finish Wash. 18-8 S/S	1
JBDL24EJA50A	6/32 thru 1/4-20 (24 comp)	Slotted Round Head Machine Screws with Nuts Brass - 1200 Pieces	1
JBDL24EKA50A	6/32 thru 1/4-20 (24 comp)	Slotted Flat Head Machine Screws with Nuts Brass - 1200 Pieces	1
JBDL24FHMS50	6/32 thru 1/4-20 (24 comp)	Slotted Flat Head Machine Screws with Nuts Z/P - 1200 Pieces	1
JBDL24PRMS50A	6/32 thru 1/4-20 (24 comp)	Phillips Round Head Machine Screws with Nuts Z/P - 1200 Pieces	1
JBDL24PTMS25	6/32 thru 1/4-20 (24 comp)	Phillips Truss Head Machine Screws Z/P - 600 Pieces	1
JBDL24BZL50A	6/32 thru 1/4-20 (24 comp)	Combo Round (Phillips/Slotted) Head Machine Screws with Nuts Z/P - 1200 Pieces	1

### SHEET METAL SCREWS

Line: 1913-00

PART NUMBER	SIZE	DESCRIPTION	QTY/BOX
JBDL20SQPT25	#6 thru #10 (20 comp)	Square Pan Sheet Metal Screws Z/P - 600 Pieces	1
JBDL24GFA25	#6 thru #14 (24 comp)	Phillips Flat Sheet Metal Screws 18-8 Stainless Steel - 600 Pieces	1
JBDL24HSMS	#6 thru 3/8 (24 comp)	Hex Head Sheet Metal Screws Z/P - 600 Pieces	1
JBDL24OSMS25S	#6 thru #14 (24 comp)	Phillips Oval Sheet Metal Screws 18-8 Stainless Steel - 600 Pieces	1
JBDL24PFMS25	#6 thru #14 (24 comp)	Phillips Flat Sheet Metal Screws Z/P - 600 Pieces	1
JBDL24PSMS25	#6 thru #14 (24 comp)	Phillips Pan Sheet Metal Screws Z/P - 600 Pieces	1
JBDL24PSMS25S	#6 thru #14 (24 comp)	Phillips Pan Sheet Metal Screws 18-8 Stainless Steel - 600 Pieces	1
JBDL24SMS25	#6 thru #14 (24 comp)	Slotted Pan Sheet Metal Screws Z/P - 600 Pieces	1
JBDL24APD25	#6 thru #14 (24 comp)	Combo Pan (Phillips / Slotted) Sheet Metal Screws Z/P - 600 Pieces	1

## ASSORTMENTS (cont.)

### 12" x 18" STEEL TRAYS

### PHILLIPS FLAT HEAD WOOD SCREWS

Line: 1913-01

PART NUMBER	SIZE	DESCRIPTION	QTY/BOX
JBDL24ASL25	#4 thru #14 (24 comp)	Phillips Flat Wood Screws Brass - 600 Pieces	1
JBDL24BEF25	#6 thru #14 (24 comp)	Phillips Flat Wood Screws 18-8 Stainless Steel - 600 Pieces	1
JBDL24PFWS25	#6 thru #14 (24 comp)	Phillips Flat Wood Screws Z/P - 600 Pieces	1
JBDL24PFWSPRO	#4 thru #12 (24 comp)	Phillips Flat Wood Screws Z/P - 2000 Pieces	1

### PHILLIPS PAN & HEX HEAD TEK DRILL SCREWS

Line: 1914-00

PART NUMBER	SIZE	DESCRIPTION	QTY/BOX
JBDL16TEK	#8 thru #12 (16 comp)	Hex Washer Head & Phillips Pan Self Drilling Screws #2 & #3 Points Z/P - 800 Pieces	1
JBDL16TEKSS	#8 thru #12 (16 comp)	Hex Washer Head & Phillips Pan Self Drilling Screws #2 & #3 Points Stainless Steel - 400 PC	1
JBDL12TEK	#6 thru #14 (12 comp)	Hex Washer Head Self Drilling Screws #2 & #3 Points Z/P - 550 Pieces	1
JBDL24HBAC	#6 thru #10 (24 comp)	Phillips Pan Self Drilling Screws #2 Points Z/P - 2200 Pieces	1
JBDL24HSDS	#6 thru #14 (24 comp)	Hex Washer Head Self Drilling Screws #2 & #3 Points Z/P - 1200 Pieces	1
JBDL16SDSS	#8 thru #14 (16 comp)	Hex Washer Head Self Drilling Screws #2 & #3 Points Stainless Steel - 375 Pieces	1
JBDL24HBA	#6 thru #14 (24 comp)	Phillips Pan Head Self Drilling Screws #2 Point Z/P - 600 Pieces	1

### SOCKET SCREWS

Line: 1915-00

PART NUMBER	SIZE	DESCRIPTION	QTY/BOX
JBDL24JJA25	6/32 thru 5/16 (24 comp)	Button Socket Set Screws 304 Stainless Steel - 600 Pieces	1
JBDL24SSSS	6/32 thru 1/2 (24 comp)	Socket Set Screws Cup Point 304 Stainless Steel - 500 Pieces	1
JBDL24ABS25	6/32 thru 5/16 (24 comp)	Button Socket Head Cap Screws Alloy P/F - 600 Pieces	1
JBDL24JAA25	6/32 thru 1/4-20 (24 comp)	Socket Head Cap Screws 304 Stainless Steel - 600 Pieces	1
JBDL24JEA25	6/32 thru 1/4-20 (24 comp)	Flat Socket Head Cap Screws 304 Stainless Steel - 600 Pieces	1
JBDL24JMR25	6/32 thru 1/4-20 (24 comp)	Socket Head Cap Screws Alloy P/F - 600 Pieces	1
JBDL24JPR25	6/32 thru 1/4-20 (24 comp)	Flat Socket Head Cap Screws Alloy P/F - 600 Pieces	1
JBDL24JWA25	6/32 thru 1/2-13 (24 comp)	Socket Set Screws Knurl Point Alloy P/F - 600 Pieces	1
JBDL24SS	6/32 thru 1/2-13 (24 comp)	Socket Set Screws Cup Point Alloy P/F - 500 Pieces	1
JBDL24SSUNF	6/40 thru 1/2-20 (24 comp)	Socket Set Screws Cup Point (Fine Thread) Alloy P/F - 500 Pieces	1

### COTTER PINS

Line: 1916-00

PART NUMBER	SIZE	DESCRIPTION	QTY/BOX
JBDL16COT25SS	1/16 thru 5/32 (16 comp)	Cotter Pins 18-8 Stainless Steel - 1125 Pieces	1
JBDL20HPIN	5/32 thru 3/4 (20 comp)	Hair Cotter Pins (Hitch Pin Clips) Z/P - 1100 Pieces	1
JBDL16S6112	1/16 thru 5/32 (16 comp)	Cotter Pins Z/P - 1600 Pieces	1

**CALL: (800) 723-2826**

# CUSTOM

## ASSORTMENTS (cont.)

### 12" x 18" STEEL TRAYS - EXCEPT WHERE NOTED

#### SPIRAL COIL PINS

Line: 1917-00

PART NUMBER	SIZE	DESCRIPTION	QTY/BOX
JBDL24SP25	1/16 thru 1/4 (24 comp)	Spiral Coil Pins P/F - 600 Pieces	1

#### SPLIT TENSION PINS

Line: 1918-00

PART NUMBER	SIZE	DESCRIPTION	QTY/BOX
JBDL24TP25	1/16 thru 1/4 (24 comp)	Tension Pins (Roll Pins) Z/P - 600 Pieces	1

#### UNIVERSAL/CLEVIS PINS

Line: 1919-00

PART NUMBER	SIZE	DESCRIPTION	QTY/BOX
JBDL16UCP05	1/4 thru 5/8 (16 comp)	Universal Clevis Pins (Multi-Hole) - 80 Pieces	1

#### WOODRUFF KEYS

Line: 1920-00

PART NUMBER	SIZE	DESCRIPTION	QTY/BOX
JBDL24WK25	1/16 thru 5/16 (24 comp)	Woodruff Keys P/F - 600 Pieces	1

#### RETAINING RINGS

INTERNAL & EXTERNAL

Line: 1921-00

PART NUMBER	SIZE	DESCRIPTION	QTY/BOX
YZBA12-100	1/4 thru 1" (24 comp)	Internal & External Retaining Rings ( 12 sizes of each) - 600 Pieces	1

#### RETAINING RINGS

Line: 1923-00

PART NUMBER	SIZE	DESCRIPTION	QTY/BOX
JBDLERC24	1/4 thru 1" (24 comp)	E-Ring (16 sizes) & C-Ring (8 sizes) Retaining Rings - 600 Pieces	1
JBDL20YXB25	1/16 thru 1 3/8 (20 comp)	E-Ring Retaining Rings - 500 Pieces	1
JBDP18YUB25	1/8 thru 1 1/4 (18 comp)	External Retaining Rings (6 3/4 x 11 Plastic Tray) - 450 Pieces	1
JBDP18YVB25	1/4 thru 1 1/4 (18 comp)	Internal Retaining Rings (6 3/4 x 11 Plastic Tray) - 450 Pieces	1
JBDP18YWB25	1/8 thru 1 1/4 (18 comp)	C-Ring Retaining Rings (6 3/4 x 11 Plastic Tray) - 450 Pieces	1
JBDP18YXB25	1/16 thru 1 (18 comp)	E-Ring Retaining Rings (6 3/4 x 11 Plastic Tray) - 450 Pieces	1
JBDL24ESR25	3/16 thru 1 3/4 (24 comp)	External Retaining Rings - 600 Pieces	1
JBDL24ISR25	1/4 thru 1 3/4 (24 comp)	Internal Retaining Rings - 550 Pieces	1

**CUSTOM ASSORTMENTS** (cont.)

**SQUARE KEY STOCK**

ZINC PLATED  
Line: 1924-00



PART NUMBER	SIZE	DESCRIPTION	QTY/BOX
JBD12-31	1/8 thru 1/2	Key Stock Z/P (12 inch pieces) - 31 Pieces (32 w/Bin)	1

**THREADED RODS W/RACK**

ZINC PLATED - UNC GRADE 2  
Line: 1924-20

PART NUMBER	SIZE	DESCRIPTION	QTY/BOX
AMLS313FT	1/4 thru 3/4 X 3'	Grade 2 Threaded Rod SAE Fine Thread Z/P - 31 Pieces	1
AML313FT	1/4 thru 3/4 X 3'	Grade 2 Threaded Rod USS Course Thread Z/P -31 Pieces	1
AML313FTB7	1/4 thru 3/4 X 3'	Grade B7 Threaded Rod USS Course Thread P/F -31 Pieces	1
AML313FTSS	1/4 thru 3/4 X 3'	Grade 304 Stainless Threaded Rod USS Course Thread - 11 Pieces total : 1 PC 7/16, 5/8, 3/4 - 2 PC 1/4, 5/16, 3/8, 1/2	1

**HOSE CLAMPS**

ALL STAINLESS STEEL  
Line: 1925-01



PART NUMBER	SIZE	DESCRIPTION	QTY/BOX
AML7HCA	Mini 4 thru M36 (7 sizes)	All Stainless Steel Hose Clamps (w/ plastic rack) - 70 Pieces (71 w/Rack)	1
AML10HCA	Mini 4 thru M36 (10 sizes)	All Stainless Steel Hose Clamps (w/ metal wire rack) - 100 Pieces (101 w/Rack)	



**CALL - 1 (800) 723-2826**

# CUSTOM

## ASSORTMENTS (cont.)

### 12" x 18" STEEL TRAYS

#### AIR BRAKE BRASS TUBE FITTINGS

Line: 1926-00

PART NUMBER	SIZE	DESCRIPTION	QTY/BOX
JBDL24AB	1/4-5/8 (24 comp) 23 sizes	Brass Air Brake Tube Fittings (Use w/ copper tubing) - 98 Pieces	1

#### BRASS PIPE THREAD FITTINGS

Line: 1927-00

PART NUMBER	SIZE	DESCRIPTION	QTY/BOX
JBDL24IPT	1/4-1/2 (24 comp) 23 sizes	Brass Pipe Thread Fittings - 94 Pieces	1

#### COMPRESSION TUBE FITTINGS

Line: 1928-00

PART NUMBER	SIZE	DESCRIPTION	QTY/BOX
JBDL24SC	3/16-3/8 (24 comp) 20 sizes	Brass Compression Tube Fittings - 100 Pieces	1

#### INVERTED FLARE TUBE FITTING

Line: 1929-00

PART NUMBER	SIZE	DESCRIPTION	QTY/BOX
JBDL24IF	3/16-3/8 (24 comp) 16 sizes	Brass Inverted Flare Tube Fittings - 80 Pieces	1

#### SAE FLARE TUBE FITTING

Line: 1930-00

PART NUMBER	SIZE	DESCRIPTION	QTY/BOX
JBDL24SF	3/16-3/8 (24 comp) 20 sizes	Brass SAE Flare Tube Fittings - 92 Pieces	1

#### POLY FLOW TUBE FITTING

Line: 1932-00

PART NUMBER	SIZE	DESCRIPTION	QTY/BOX
JBDL24PF	1/8-3/8 (24 comp) 20 sizes	Brass Poly Flow Tube Fittings - 140 Pieces	1

#### NYLON TRUCK TUBE FITTING J844

Line: 1933-00

PART NUMBER	SIZE	DESCRIPTION	QTY/BOX
JBDL24TH	1/4-5/8 (24 comp) 22 sizes	Brass Air Brake J844 Tube Fittings (Use w/ nylon J844 tubing) -123 Pieces	1

#### BLACK IRON PIPE FITTINGS

Line: 1933-01

PART NUMBER	SIZE	DESCRIPTION	QTY/BOX
JBDL24IPF85	1/8 thru 1/2 (24 comp)	150# Malleable Black Iron Pipe Fittings - 71 Pieces	1

## ASSORTMENTS (cont.)

### 12" x 18" STEEL TRAYS

### STAINLESS STEEL PIPE FITTINGS

Line: 1933-01

PART NUMBER	SIZE	DESCRIPTION	QTY/BOX
JBDL24SSPF85	1/8 thru 1/2 (24 comp)	304 Stainless Steel Pipe Fittings - 85 Pieces	1

### BLIND RIVETS

Line: 1934-00

PART NUMBER	SIZE	DESCRIPTION	QTY/BOX
JBDL16BR	1/8 thru 3/16 (16 comp)	Button & Large Flange Blind (Pop) Rivets All Alum & All Steel - Assorted - 1450 Pieces	1
JBDL12BRSSSS	1/8 thru 3/16 (12 comp)	Button & Large Flange Blind (Pop) Rivets Stainless Steel - 475 Pieces	1
JBDL21BR	1/8 thru 3/16 (21 comp)	Button & Large Flange Blind (Pop) Rivets All Alum & All Steel w/ Tool - Assorted - 1801 PC	1

### LOW PRESSURE PUSH-ON HOSE FITTINGS

Line: 1935-00

PART NUMBER	SIZE	DESCRIPTION	QTY/BOX
JBDL24POF	1/8-3/8 (24 comp)	Brass Low Pressure Push On Hose Fittings (No hose clamps needed) - 46 Pieces	1

### ELECTRICAL WIRE TERMINALS

Line: 1937-00

PART NUMBER	SIZE	DESCRIPTION	QTY/BOX
JBDLATO/MIN	5 thru 40 AMP (24 Comp)	ATO & Mini ATO Fuses with ATO Fuse Holders - 105 Pieces	1
JBDLFUSEKIT	3 thru 30 amp (24 comp)	GBC-SFE Glass & ATO Blade Fuses with Fuse Holders - 195 Pieces	1
JBDL16KSWT	22 thru 12 Ga. (16 Comp)	Krimp and Seal (water & moisture resistant) Wire Terminals - 160 Pieces	1
JBDL21NYWT	22 thru 12 Ga. (21 Comp)	Nylon Wire Terminals with Crimp Tool - 476 Pieces	1
JBDL24GLFUSE	2 thru 30 amp (24 comp)	AGA-AGC-AGW-AGX Glass Fuses - 230 Pieces	1
JBDL24HSWT25	22 thru 12 Ga. (24 comp)	Krimp Seal Heat Shrink Wire Terminals - 235 Pieces	1
JBDL24NYWT	22 thru 12 Ga. (24 comp)	Nylon Wire Terminals - 550 Pieces	1
JBDL24WT25	22 thru 12 Ga. (24 comp)	Vinyl Wire Terminals - 600 Pieces	1
JBDL20SLDSLWT	22 thru 12 Ga. (20 comp)	Solder Seal Heat Shrink Wire Terminals - 90 Pieces	1

### ELECTRICAL WIRE NUT - AWG SERIES

Line: 1937-01

PART NUMBER	SIZE	DESCRIPTION	QTY/BOX
JBDL12SWN25	22 thru 6 Ga. (12 comp)	Ideal Style Wire Nuts - 175 Pieces	1
JBDL12WN25R	22 thru 6 Ga. (12 comp)	Wing Style Wire Nuts - 175 Pieces	1

# CUSTOM

## ASSORTMENTS (cont.)

### 12" x 18" STEEL TRAYS

#### HEAT SHRINK - DOUBLE WALL TUBING

Line: 1937-02

PART NUMBER	SIZE	DESCRIPTION	QTY/BOX
JBDL24ST	1/8 thru 1/2 (6 comp)	Heat Shrink Tubing - 50 Pieces	1

#### NYLON CABLE TIES

Line: 1937-03

PART NUMBER	SIZE	DESCRIPTION	QTY/BOX
JBDL6CDN	5" thru 16" (Adj. comp)	Standard (Black) Cable Ties - 500 Pieces	1
JBDL8NYT	5" thru 16" (Adj. comp)	Tyton-Hellerman (Black) Cable Ties with Adhesive Mounts - 525 Pieces	1

#### GREASE FITTINGS

Line: 1938-00

PART NUMBER	SIZE	DESCRIPTION	QTY/BOX
JBDL16GF25	1/8 - 1/4IPT & 1/4-28 (16 comp)	US Standard Grease Fittings - 400 Pieces	1
JBDL12GF25MET	6MM thru 10MM (12 comp)	Metric Grease Fittings - 91 Pieces	1
JBDL20GF-PRO	US & METRIC (20 comp)	US Standard & Metric Grease Fittings - 241 Pieces	1

#### RUBBER O-RINGS

Line: 1939-00

PART NUMBER	SIZE	DESCRIPTION	QTY/BOX
JBDL12YSA	1/4 thru 1" (12 comp)	Boss & Seal-Lok Hydraulic O-Rings - 120 Pieces	1
JBDL12ZNB	1/8 thru 3/4 (12 comp)	Rubber Grommets - 120 Pieces	1
JBDL24RORV25	1/8 thru 1 3/8 I.D. (24 comp)	Viton O-Rings - 600 Pieces	1
JBDL24ROR25	1/8 thru 1 3/8 I.D. (24 comp)	Buna-N O-Rings - 600 Pieces	1



CALL - 1 (800) 723-2826



**CUSTOM****ASSORTMENTS** (cont.)**12" x 18" STEEL TRAYS****CUSTOM PRODUCTS***Line: 1939-20*

PART NUMBER	SIZE	DESCRIPTION	QTY/BOX
<b>JBDLFLTTCN</b>	3/16 thru 1/4 dia (16 comp)	Phillips Flat Head (Tapcon) Masonary Anchoring Screws - 350 Pieces	1
<b>JBDLHEXTCN</b>	3/16 thru 1/4 dia (16 comp)	Hex Washer Head (Tapcon) Masonary Anchoring Screws - 350 Pieces	1
<b>JBDL16AZA</b>	1/8 thru 1/2 I.D. (16 comp)	Fender Washers Z/P - 370 Pieces	1
<b>JBDL24BSKSS</b>	M4 thru M10 (24 comp)	Metric Socket Set Screws A2 Stainless Steel - 600 Pieces	1
<b>JBDL24CCC25</b>	M4 thru M10 (24 comp)	Metric Socket Set Screws Din 916 P/F - 600 Pieces	1
<b>JBDL24IELW</b>	#6 thru 3/4 (24 Comp)	Internal & External Lock Washers Z/P - 1800 Pieces	1
<b>JBDL12UBB25</b>	1/8 thru 1/4 (12 comp)	Standard & Drive Style Hollow Wall Anchors - 300 Pieces	1
<b>JBDL24BLB</b>	1/8 thru 3/4 (24 comp)	Brass Male Hose Barb Connectors - 81 Pieces	1

**METRIC HEX CAP SCREW 8.8***Line: 1940-00*

PART NUMBER	SIZE	DESCRIPTION	QTY/BOX
<b>CPC600</b>	M3 thru M10 (24 comp)	Metric 8.8 Hex Head Cap Screws Din 933 w/ Nuts Z/P - 600 Pieces	1
<b>JBDL24METNW25</b>	M3 thru M10 (24 comp)	Metric Nuts, Washers, Lock Nuts, Lock Washers & Internal Lock Washers Z/P - 600 Pieces	1
<b>CPC440A2</b>	M4 thru M10 (20 comp)	Metric A2 Stainless Steel Hex Head Cap Screws w/ Nuts - 440 Pieces	1
<b>CPC440</b>	M4 thru M10 (20 comp)	Metric 8.8 Hex Head Cap Screws w/ Nuts Z/P - 440 Pieces	1
<b>CPC440F</b>	M4 thru M10 (20 comp)	Metric 8.8 (Fine Thread) Hex Head Cap Screws w/ Nuts Z/P - 440 Pieces	1
<b>CPC200</b>	M8 thru M16 (16 comp)	Metric 8.8 Hex Head Cap Screws w/ Nuts Z/P - 200 Pieces	1

**METRIC SOCKET CAP SCREWS 12.9***Line: 1941-00*

PART NUMBER	SIZE	DESCRIPTION	QTY/BOX
<b>CPC380</b>	M4 thru M10 (24 comp)	Metric 12.9 Socket Head Cap Screws Din 912 P/F - 380 Pieces	1
<b>CPC380A2</b>	M4 thru M10 (24 comp)	Metric A2 Stainless Steel Socket Head Cap Screws - 380 Pieces	1
<b>CPC158</b>	M8 thru M16 (16 comp)	Metric 12.9 Socket Head Cap Screws Din 912 P/F - 158 Pieces	1

# ASSORTMENTS (cont.)

## 12" x 18" STEEL TRAYS

### METRIC MACHINE SCREWS

Line: 1942-00

PART NUMBER	SIZE	DESCRIPTION	QTY/BOX
<b>JBDL24CHC25WN</b>	M3 thru M6 (24 comp)	Metric Slotted Flat Head Machine Screws Din 963A w/ Nuts Z/P - 600 Pieces	1
<b>JBDL24CJC25WN</b>	M3 thru M6 (24 comp)	Metric Slotted Pan Head Machine Screws Din 85A w/ Nuts Z/P - 600 Pieces	1
<b>JBDL24CMC25</b>	M3 thru M6 (24 comp)	Metric Phillips Flat Head Machine Screws Din 965A Z/P - 600 Pieces	1
<b>JBDL24CMC25WN</b>	M3 thru M6 (24 comp)	Metric Phillips Flat Head Machine Screws Din 965A w/ Nuts Z/P - 600 Pieces	1
<b>JBDL24CNC25</b>	M3 thru M6 (24 comp)	Metric Phillips Pan Head Machine Screws Din 7985 Z/P - 600 Pieces	1
<b>JBDL24CNC25WN</b>	M3 thru M6 (24 comp)	Metric Phillips Pan Head Machine Screws Din 7985 w/ Nuts Z/P - 600 Pieces	1
<b>CPC590</b>	M4 thru M8 (24 comp)	Metric Slotted Flat Din 963A & Pan Din 85A Head Machine Screws w/ Nuts Z/P - 590 Pieces	1

### METRIC SET SCREWS & FLAT SOCKET CAP SCREWS

Line: 1943-00

PART NUMBER	SIZE	DESCRIPTION	QTY/BOX
<b>CPCCFC510</b>	M5 thru M10 (20 comp)	Metric Flat Socket Cap Screws Din 7991 P/F - 510 Pieces	1
<b>CPC425</b>	M5 thru M16 (24 comp)	Metric Flat Socket Cap Din 7991 & Socket Set Screws Din 916 P/F - 425 Pieces	1



**CALL - 1 (800) 723-2826**